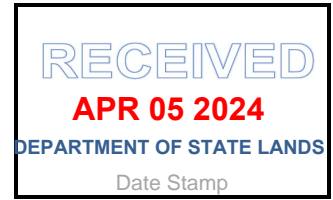


Joint Permit Application

This is a joint application, and must be sent to all agencies (Corps, DSL, and DEQ). Alternative forms of permit applications may be acceptable; contact the Corps and DSL for more information.



 <p>U.S. Army Corps of Engineers Portland District</p>	 <p>Oregon Department of State Lands</p>	 <p>Oregon Department of Environmental Quality</p>
Action ID Number	Number 65011	

(1) TYPE OF PERMIT(S) IF KNOWN (check all that apply)

Corps: Individual Nationwide No.: _____ Regional General Permit _____ Other (specify): _____

DSL: Individual GP Trans GP Min Wet GP Maint Dredge GP Ocean Energy No Permit Waiver

(2) APPLICANT AND LANDOWNER CONTACT INFORMATION

	Applicant (Incumbency Certificate included in Attachment A)	Property Owner (if different)	Authorized Agent (if applicable)
Name (Required)	Knife River Corporation – Northwest c/o Jeff Steyaert	Weyerhaeuser NR Company c/o Mary Castle	Greg Summers, SPWS
Business Name	Knife River Corporation	Weyerhaeuser NR Company	Anchor QEA, LLC
Mailing Address 1	32260 Old Highway 34	33671 S. Dickey Prairie Road	6720 S. Macadam Avenue
Mailing Address 2			Suite 300
City, State, Zip	Tangent, Oregon 97389	Molalla, Oregon 97038	Portland, Oregon 97219
Business Phone	(541) 918-5142	(503) 479-2309	(503) 924-6196
Cell Phone			
Fax			
Email	jeff.steyaert@kniferiver.com	mary.castle@weyerhaeuser.com	gsummers@anchorqea.com

(3) PROJECT INFORMATION

A. Provide the project location.

Project Name Watters Quarry Phase II	<u>Latitude & Longitude*</u> 45.871334°/-122.823218°			
Project Address / Location 60371 N Columbia River Hwy	City (nearest) St. Helens			
	County Columbia County			
Township	Range	Section	Quarter / Quarter	Tax Lot
5 North	1 West	32	SE 1/4 of SE 1/4	Portion of 51W32DD00100
5 North	1 West	33	S 1/2 of NW 1/4	Portion of 51W330000300
5 North	1 West	33	N 1/2 of SW 1/4	Portion of 51W330000400
5 North	1 West	32	NE 1/4 of SE 1/4	Portion of 51W320001600

Brief Directions to the Site:

Please contact the Applicant before performing any site visits. The project site is located on private property that is not accessible to the public. All site visits must be coordinated and approved by the Applicant, per safety protocol. From Portland, Oregon, take Interstate 405 North (I-405 N) toward U.S. Highway 30 West (US-30 W) toward St. Helens. Drive approximately

27.6 miles north on US-30 W, then turn left onto Liberty Hill Road, then turn right into the Knife River Corporation parking lot. The project site is located west of the parking lot and accessed from Liberty Hill Road (Figures 1 through 4).

B. What types of waterbodies or wetlands are present in your project area? (Check all that apply.)

- River/Stream Non-Tidal Wetland Lake/Reservoir/Pond
 Estuary or Tidal Wetland Other Pacific Ocean

		<u>6th Field HUC Name</u>	<u>6th Field HUC (12 digits)</u>
Wetlands A through U, Z, AA through FF, OO through TT, XX through ZZ, and 1-A; Perennial Stream 1-A; Intermittent Streams B, Tributary to Intermittent Stream B, C, and D; Ephemeral Streams B, C, D, and 1-A	N/A	Milton Creek (western portion)	170900120303 (western portion)
		Deer Island Slough-Frontal Columbia River (eastern portion)	170800030401 (eastern portion)

* In decimal format (e.g., 44.9399, -123.0283)

** If there is no official name for the wetland or waterbody, create a unique name (such as "Wetland 1" or "Tributary A").

C. Indicate the project category. (Check all that apply.)

- Commercial Development Industrial Development Residential Development
 Institutional Development Agricultural Recreational
 Transportation Restoration Bridge
 Dredging Utility lines Survey or Sampling
 In- or Over-Water Structure Maintenance Other: Rock Quarry

(4) PROJECT DESCRIPTION

A. Summarize the overall project including work in areas both in and outside of waters or wetlands.

The proposed Watters Quarry Phase II Project (project) involves the expansion of Watters Quarry Phase I (Phase I), an existing active high-quality aggregate mining operation at the Applicant’s Watters Quarry site in St. Helens, Columbia County, Oregon (Figures 1 through 4). The Phase I quarry is located north of Liberty Hill Road in the northeastern portion of tax lot 51W330000300 and covers approximately 27 acres. Tax lot 51W330000300 is owned by the Weyerhaeuser Company and leased by the Applicant for mineral extraction. Aggregate mining at Watters Quarry has been occurring since before 1953, and the Applicant has nearly reached the end of the mineable basalt reserves north of Liberty Hill Road, with only an estimated 2 years of operative life remaining. The proposed project also includes on-site compensatory mitigation for unavoidable impacts to wetlands and other waters (e.g., streams).

In order to continue high-quality aggregate production at Watters Quarry, the Applicant is proposing to continue the mining operation to the south to maintain the current needed supply of aggregate to the market. The proposed project site would include the remaining 44-acre portion of tax lot 51W330000300 on the south side of Liberty Hill Road, which is part of the originally approved mining area, and adjacent tax lots 51W32DD00100, 51W320001600, and 51W330000400 to the south (totaling 125 acres), which are also owned by Weyerhaeuser Company and leased by the Applicant for mining (Figure 3). Tax lots 51W320001600 and 51W330000400 are zoned as Primary Forest Zone – 80 (PF-80) but were approved for aggregate mining by Columbia County (County) in 1992 with the issuance of Conditional Use Permit CU 22-92 (Attachment B). That permit added an additional 130 acres of minable land to the approved mining area, which included the southernmost 55 acres within the City of St. Helens Urban Growth Boundary before tax lot 51W32DD00100 was added. However, in accordance with the County Zoning Ordinance (Section 1040, Surface Mining) and the Applicant’s existing Oregon Department of Geological and Mineral Industries (DOGAMI) Operating Permit (Permit No. 05-0018; Attachment C), the excavation limits on the project site would be limited by a 200-foot setback from residential property boundaries and a 50-foot setback from all non-residential

property boundaries. Consequently, of the approximately 169 acres included in these tax lots south of Liberty Hill Road, 99 acres would remain in buffer or be used for mitigation, and approximately 70 acres would be used for mining. Overall, the proposed 70-acre mining area is expected to provide a supply of high-quality aggregate for over an approximately 50-year period, pending market demand.

Aggregate mining in the proposed project area would require the direct excavation of approximately 10.14 acres of wetlands and a 0.002-acre intermittent stream that are in the proposed footprint of mining operations (Figures 5, 6a through 6e, 7, 8a, and 8b). As a result, those wetlands and streams would be eliminated. Indirect impacts on 1.42 acres of wetlands and 0.058 acre of intermittent streams could also occur from the alteration of hydrology. Over time, those areas may be adversely affected by hydrologic changes from the proposed project and are therefore included in the impact total (11.56 total acres). *Note:* On November 10, 2023, the Applicant requested a new Approved Jurisdictional Determination (AJD) from the U.S. Army Corps of Engineers (USACE) to determine the number of federal jurisdictional wetland and water areas impacted by the Project. On March 29, 2024, the USACE completed the AJD review of the project site and issued the determination that the aquatic resources and wetlands in the review area are not waters of the United States, and the proposed activity would not occur in waters of the United States; therefore, a Department of Army permit is not required for the proposed work as described in this application.

Mining operations on the project site would occur in three stages (Figure 9) and would only disturb the area needed to produce the volume of aggregate for market demand projected over an approximately 13- to 15-year period per stage. Disturbance would be limited to areas within the active stage, and the remaining land in the Phase II site would remain undisturbed and in its existing condition aside from creation of the proposed on-site compensatory mitigation areas. Compensatory mitigation would be completed prior to any impacts to track success of the mitigation and initiate temporal functional loss replacement. Upon completion of the aggregate extraction on the site, reclamation would occur in accordance with County and DOGAMI regulations. Reclamation would include creating a lake feature surrounded by native tree, shrub, and herbaceous vegetation suitable for native wildlife habitat.

The goal of the mitigation plan is to compensate for lost functions of impacted wetlands and streams with the successful creation of 18.32 acres of compensatory wetland mitigation that exceeds the 17.34 acres of wetland mitigation credits required. The mitigation will compensate for the 0.39 acre of permanent palustrine emergent (PEM), 4.09 acres of permanent palustrine forested (PFO), and 7.08 acres of permanent PFO/PEM wetland impacts (10.14 acres of direct impact and 1.42 acres indirect impact for 11.56 total acres) associated with the project. Of the 0.39 acre of PEM impact, 0.35 acre is wetlands that have been identified as Aquatic Resources of Special Concern (ARSC), which will also be compensated for with implementation of the mitigation plan. Of the 1.42 acres of PFO/PEM indirect impacts, approximately 0.26 acre consists of ARSC wetlands that will also be compensated for with the mitigation plan. The mitigation also includes 1.12 acres of perennial stream creation that exceeds the 0.09 acre of stream mitigation credits required. In addition to wetland creation, some enhancement of existing wetlands will also occur as part of the overall mitigation strategy. Enhancement is not accepted by the agencies as mitigation and is not included in the compensatory mitigation acreage; however, enhancement of these existing wetland areas is proposed to aid in achieving the overall goal of establishing a diverse, native wetland plant community with few invasive species and a forested canopy, with a scrub-shrub and herbaceous understory. Enhancing wetlands adjacent to the created mitigation wetlands through invasive species removal and native plantings will increase the effectiveness of the overall mitigation.

The main objective of the mitigation is to replace impacted wetland and stream functions by creating similar habitat to what would be impacted. Created wetland habitat types will include wetland forested, scrub-shrub, and emergent communities, including the creation of wet prairie and wet rock outcrop conditions to compensate for similar types of impacted wetlands. Existing high-value habitat and individual trees (e.g., larger oaks) would be avoided as much as feasible during mitigation construction. The mitigation plan includes the planting of native upland trees, scrub-shrub, and herbaceous communities on slopes adjacent to the wetlands, which will provide buffers from quarry activities. Further detail of the proposed mitigation approach and design is provided in Joint Permit Application (JPA) Section 9 and in the attached compensatory mitigation plan (Attachment D).

Project Stages and Reclamation

Phase II mining will occur over three mining stages, as described in the following sections and shown in Figure 9. It is estimated that resources in each mining stage will last about 13 to 15 years before advancing into the next mining stage area. Mining stages will be approximately 21 to 25 acres in size, and each stage will represent about one-third of the area within the proposed Phase II mining boundary. Stage 1 will include 24.43 acres, which will enable extraction of resource to total permit depth. Stage 2 will include 25.18 acres, and Stage 3 will include 21.61 acres.

Mining Stage 1

Mining within this stage begins with surveying the mining boundary and flagging the boundary in the field.

Vegetation removal will begin with a dozer and excavator loading the vegetation into haul trucks to be sorted for temporary storage. Select plants will be harvested with root balls intact for use in the mitigation areas or adjacent buffers. Once vegetation is removed, a dozer and excavator will be used to remove the overburden above the basalt rock surface and haul to Overburden Storage Area 1. Any wetland soil material removed will be kept separate for potential use to supplement the mitigation areas. Overburden Storage Area 1 will be marked in the field and will avoid any wetlands, then leveled with a dozer and excavator prior to receiving the overburden from Mining Stage 1 (Figure 9). The overburden storage will be seeded with native grass prior to the October rainy season. The overburden pile will have silt fences and berms to prevent sediment runoff until the grass seed stabilizes the pile. Most of the existing haul roads will be used to transport brush and overburn to these storage areas. Land disturbance will take place during the drier months to minimize erosion. Any overburden taken from the mitigation areas will be temporarily stored in one of the two overburden storage areas to be used to supplement overall mitigation design (e.g., restoring riparian zones) or placed in any of the final mining bench areas for reclamation. Large woody debris (LWD) and brush vegetation will be used in the mitigation area where it can be beneficial for wildlife habitat and support wetland and stream functions. Any excess woody debris or brush will be chipped and used for erosion control.

Mining will then commence with drilling and blasting the surface basalt. Once the basalt is fractured it is then loaded into haul trucks and transported to the existing processing yard located on the Phase I site where it will be crushed into various size rock based on the market demand. The blasting and extraction process continues until the floor reaches an elevation of 0 (zero) feet mean sea level (MSL). It is estimated that Mining Stage 1 resources will last about 13 to 15 years before advancing south into the Mining Stage 2 area (Figure 9).

Stormwater within the Mining Stage 1 area will be captured and pumped into multiple settling ponds located in the Mining Stage 1 area, where any sediment from the mining operation can settle out before pumping out of the active mining area towards the existing surface outlets in the Eastern Basin (Figure 9). Most of the captured stormwater will be directed towards the surface and subsurface flow that currently drains out of Wetland N and surrounding uplands (see Figure 4 in Attachment D) in order to maintain current flow volumes to off-site waters. There will be drainage ditches within the quarry to keep rainwater from accumulating where equipment will be operating to minimize sediment in the water. This water will also be returned to the existing surface outlets in the Eastern Basin. As part of the 1200-A stormwater permit, on-site personnel will monitor the clarity and any other possible pollutants, such as an oil sheen on the water before the pumps are turned on and discharged off site into the existing Eastern Basin.

Mining Stage 2

Mining within Stage 2 will be like that of Stage 1, making sure all setbacks are clearly marked in the field before vegetation removal and excavation commences. Vegetation will be hauled off and placed in one of the brush pile areas to be sorted for use in the mitigation area or chipped for use as erosion control. Overburden will be placed in the final mining benches along the east side of Mining Stage 1 (Figure 9). Once placement is complete, the soil slope will be vegetated with native grass seed to stabilize from erosion and then planted with native trees and shrubs.

Stormwater will be managed as stated in Mining Stage 1 with new settling ponds constructed in the Mining Stage 1 area, prior to any discharge off site into the existing Eastern Basin. If needed, additional settling ponds would be constructed in the Mining Stage 1 area.

Mining Stage 3

Mining within Stage 3 will be like that of Mining Stages 1 and 2, making sure all setbacks are clearly marked in the field before vegetation removal and excavation commences. Vegetation will be hauled off and placed in one of the brush pile areas to be sorted for use in the mitigation area or chipped for use as erosion control. Overburden will be placed in the final mining benches along the east sides of Mining Stages 1 and 2 (Figure 9). Once placement is complete, the soil slope will be vegetated with native grass seed to stabilize from erosion and then planted with native trees and shrubs.

Stormwater will be managed as stated in Mining Stages 1 and 2 with new settling ponds constructed in the floor of Mining Stage 2, prior to any discharge off site into the existing Eastern Basin. If needed, additional settling ponds would be constructed in the Mining Stage 1 and 2 areas.

B. Describe work within waters and wetlands.

Proposed work on the project site would include the removal of existing vegetation and between 0 to 5 feet of the soil, or excavation of exposed overburden that overlies the basalt bedrock that would be mined for aggregate. This work would directly affect approximately 10.14 acres of wetlands and a 0.002-acre intermittent stream in the proposed project area and would completely eliminate those areas (Figures 5, 6a through 6e, 7, and 8a and 8b). The work could also indirectly impact approximately 1.42 acre of wetlands and 0.058 acre of intermittent streams through the interruption of surface flow. Over time, those existing wetlands and streams may be adversely affected, so they are included in the impact acreage for compensatory mitigation.

The proposed wetland and other water impacts and associated removal volumes for each work area are further described in the following sections. The removal impact area and volume summary tables are provided in Attachment E. No fill is proposed to be placed in wetlands or streams on the project site.

C. Construction Methods. Describe how the removal and/or fill activities will be accomplished to minimize impacts to waters and wetlands.

The proposed project would remove approximately 16 million cubic yards (cy) of material, of which approximately 100,000 cy would be topsoil and overburden and approximately 1 million cy would be the interflow volume. The interflow refers to the contact zone between the Sentinel Bluffs Member geologic unit and the older Winter Water Member geologic unit of the Grande Ronde Basalt (GRB) of the Columbia River Basalt Group (CRBG) (Wells et. al 2020) that comprise the geology of the project site. The location of the interflow contact is where infiltration and fissures have the greatest potential to occur in the geologic complex. In the Phase II area, this interflow contact is observed at a depth of approximately 82 feet below the ground surface (157 feet MSL) (Staley 2021), which is below the final elevation of the mitigation area. Interflow zones between basalt flows may have accumulations of sedimentary deposits or slightly weathered basalt in the underlying flow. These interflow deposits tend to be silty to clayey and not marketable. The total volume of marketable basalt resource is estimated to be 15 million cy, or 33 million tons. Mining operations would begin with the removal of 0 to 5 feet of the overburden using excavators, bulldozers, scrapers, haul trucks, and similar equipment. The underlying basalt rock would then be mined using a drilling and blasting method similar to methods currently used at the Phase I site. Drilling and blasting for rock mining is performed by drilling numerous holes in the rock, filling the holes with explosives, and then detonating the explosives to break up the rock. Once extracted, the rock would be loaded into haul trucks or transported via conveyor to the existing processing crusher on the Phase I site, which would remain within the current active mining area keeping existing noise levels and location. The crusher would be used to crush the rock into different products for stockpiling on site and eventual shipment off site. The mining equipment, crusher, and drilling and blasting operations would remain in place, below grade, and behind an excavation face to maintain existing levels of noise and visual impacts on neighboring properties. Equipment used for operations may include a crusher, drilling and blasting equipment, water trucks, excavators, front-end loaders, graders, excavators, haul trucks, and bulldozers.

Equipment access to the Phase II site would occur via the Phase I site. Equipment would initially cross Liberty Hill Road into the Phase II site to the south via a new gravel road that would climb out of the Phase I site. Once mining in the northern portion of the Phase II site brings the elevation close to the bottom elevation of the Phase I site, an undercrossing beneath Liberty Hill Road may be constructed to connect the two areas. If constructed, this undercrossing would allow for vehicles, equipment, and conveyors to cross between the project site and the processing area at the Phase I site without having to cross Liberty Hill Road.

Stormwater management is described in the Applicant's Stormwater Pollution Control Plan (SWPCP), which is included in Attachment F. The area disturbed by mining would be contoured such that stormwater is captured within the mining site. All direct precipitation would be shed internally toward stormwater treatment ponds and then discharged in accordance with the site's National Pollutant Discharge Elimination System (NPDES) 1200-A General Permit. For erosion and sediment control during mining activities, a street sweeper will be used as necessary to control sediment and rock debris tracking within the internal paved haul roads and just before exiting the mining site and prior to off-site roadways. Screens, booms, or other measures will also be used to control debris in stormwater discharge.

As part of the mitigation plan, a perennial stream, overland flow, and other runoff from adjacent, upslope areas would be routed to the proposed mitigation areas and around the mining area to prevent that water from entering the pit. In addition, elevated berms will be established between the mitigation areas and the mining site where needed to further prevent any flow from entering the pit. Stormwater in the quarry would be directed away from the active mining area and contained within settling ponds. Once this stormwater meets NPDES permit requirements, it would be pumped from the settling ponds to existing discharge points along the eastern and southern boundaries of the project site (Figure 4 in Attachment D). On-site employees

would monitor the clarity of the water before the pump is turned on and record the results, as necessary to comply with the NPDES 1200-A General Permit.

Aside from the mining area, a drainage basin of approximately 60 acres discharges water to the east into a series of ditches and small drainages that ultimately enter the Columbia River. The remaining discharge, separate from the mining area, drains to the west (a drainage basin [Western Basin] of approximately 32 acres) and some of that flow ultimately enters Milton Creek. Portions of that flow are also retained in depressional areas, such as existing Wetland C, and that hydrology eventually evaporates or flows subsurface. Some of the water in the Western Basin would be collected and routed toward the mitigation area to provide an additional source of hydrology. Similar to the existing wetlands on the site, some of that rerouted upslope hydrology would be retained in the mitigation areas and eventually evaporate. During high precipitation events, some of that water would overflow downslope and eventually into Milton Creek, similar to existing conditions.

Once the site is exhausted of its aggregate resources, the Phase II mining area would be reclaimed in accordance with the Applicant's DOGAMI Reclamation Plan (Attachment G). The goal of the Reclamation Plan is to create stable, usable land after mining ceases. Reclamation would occur by creating a large lake surrounded by mixed vegetation (Figure 9 in Attachment D). The lake and surrounding wooded area would create a mixed use for natural wildlife habitat and recreational use. Reclamation would begin by stockpiling topsoil in strategic areas within the project site. The stockpiles would be quickly vegetated to preserve the soil structure and prevent erosion. As areas are mined, topsoil would be spread in thicknesses similar to original conditions. The topsoil would be spread no thinner than 1 foot over the exposed rock. All bare soils will be vegetated with grass seed for erosion control. After spreading and contouring, native vegetation would be planted in the reclamation area. Vegetation would include a variety of grasses, legumes, and other native groundcovers mixed with native shrubs and trees. Bare rock walls created by the mining process may remain unvegetated if they are too steep to establish vegetation. Note that the Reclamation Plan will be required to be revised by the Oregon Department of Geology following permit issuance under Section 404 of the Clean Water Act for the proposed project. This revised Reclamation Plan will omit the approximately 49-acre area in the northern, western, and southern portions of the project site where the proposed compensatory wetland mitigation areas will occur prior to mining operations.

References

Staley, Erick, 2021, *Mine Resource Evaluation Report Phase 2 Mine Area*. Unpublished NV5 Report. p. 36.

Wells, R.E., Haugerud, R.A., Niem, A.R., Niem, W.A., Ma, Lina, Evarts, R.C., O'Connor, J.E., Madin, I.P., Sherrod, D.R., Beeson, M.H., Tolan, T.L., Wheeler, K.L., Hanson, W.B., and Sawlan, M.G., 2020, Geologic map of the greater Portland metropolitan area and surrounding region, Oregon and Washington, U.S. Geological Survey, Scientific Investigations Map SIM-3443, 1:63,360.

D. Describe source of fill material and disposal locations if known.

The proposed project would not involve the direct placement of fill material into existing wetlands and streams on the project site; all direct project impacts to wetlands and other waters would occur from excavation, with some potential indirect impacts to wetlands and streams on the project site caused by changes in upslope drainage patterns. Excavated wetland soils would be transported to upland areas on the project site for potential use as a supplementary growing medium for the compensatory mitigation areas to enhance or add to wetland creation.

E. Construction timeline.

What is the estimated project start date?

Late Summer/Fall 2024

What is the estimated project completion date?

Approximately 50 years from permit issuance date

**Is any of the work underway or already complete?
If yes, please describe.**

No work on the proposed project is underway or already complete.

F. Removal Volumes and Dimensions (See Attachment E)

Wetland / Waterbody Name * See Attachment E, Table E-1	Removal Dimensions					Time Removal is to remain**	Material***
	Length (ft.)	Width (ft.)	Depth (ft.)	Area (sq.ft. or ac.)	Volume (c.y.)		

G. Total Removal Volumes and Dimensions

Total Removal to Wetlands and Other Waters	Length (ft.)	Area (sq. ft or ac.)	Volume (c.y.)
Total Removal to Wetlands	Varies	10.1423 ac.	90,248
Total Removal Below Ordinary High Water	107	0.002 ac.	4
Total Removal Below Highest Measured Tide			
Total Removal Below High Tide Line			
Total Removal Below Mean High Water Tidal Elevation			

H. Fill Volumes and Dimensions (if more than 7 impact sites, include a summary table as an attachment)

Wetland / Waterbody Name*	Fill Dimensions					Time Fill is to remain**	Material***
	Length (ft.)	Width (ft.)	Depth (ft.)	Area (sq. ft. or ac.)	Volume (c.y.)		

(4) PROJECT DESCRIPTION (CONTINUED)

I. Total Fill Volumes and Dimensions

Total Fill to Wetlands and Other Waters	Length (ft.)	Area (sq. ft or ac.)	Volume (c.y.)
Total Fill to Wetlands			
Total Fill Below Ordinary High Water			
Total Fill Below Highest Measured Tide			
Total Fill Below High Tide Line			
Total Fill Below Mean High Water Tidal Elevation			

*If there is no official name for the wetland or waterbody, create a unique name (such as "Wetland 1" or "Tributary A").
 **Indicate whether the proposed area of removal or fill is permanent or, if you are proposing temporary impacts, specify the days, months or years the fill or removal is to remain.
 *** Example: soil, gravel, wood, concrete, pilings, rock etc.

(5) PROJECT PURPOSE AND NEED (See Attachment H)

Provide a statement of the purpose and need for the overall project.
 The project purpose and need are provided in Attachment H.

(6) DESCRIPTION OF RESOURCES IN PROJECT AREA

A. Describe the existing physical, chemical, and biological characteristics of each wetland or waterbody. Reference the wetland and waters delineation report if one is available. Include the list of items provided in the instructions.

Wetlands and Other Waters

Pacific Habitat Services, Inc. (PHS), performed a wetland delineation on the project site and adjacent properties in February, March, and April 2018; April, May, June, and July 2019; and March 2020. The study area for that delineation included the proposed project area; the remaining off-site portions of tax lots 1600 and 400; tax lots 51W32DD00100, 41W05AA11200, and 41W04B000400; and a portion of tax lot 41W04B000900. The results of the delineation were presented in a September 2019 wetland delineation report titled *Wetland Delineation for Watters Quarry, St. Helens, Oregon*, which was submitted to Oregon Department of State Lands (DSL) on November 22, 2019 (PHS 2019) and assigned DSL File No. WD2019-0623. PHS also provided DSL with two follow-up memoranda on July 17 and August 5, 2020, in response to DSL’s requests for additional information (PHS 2020a, 2020b). Anchor QEA, LLC, performed an additional wetland delineation in 2021. The results of that delineation were presented in a March 2021 memorandum titled *Watters Quarry Expansion Project Wetland Delineation Addendum (WD No. 2019-0623)* (Anchor QEA 2021). The delineations identified 38 freshwater wetlands, one perennial stream, four intermittent streams, and four ephemeral streams on the project site. An additional 23 wetlands, one intermittent stream, and four ephemeral streams were identified in the surrounding off-site areas. Photographs from the 2019 delineation report and subsequent 2021 delineation memorandum are provided in Attachment I. DSL issued a wetland delineation concurrence letter on April 28, 2021 (Attachment J).

Each of the identified wetlands and other waters is shown in Figures 5 and 6a through 6e, summarized in Table 2, and briefly described in the following sections. No vernal pools, bogs, fens, mature forested wetlands, seasonal mudflats, or native wetland prairies were identified on the project site; however, several of the delineated wetlands (Wetlands L, O through U, PP, QQ, RR, SS, and XX) that have been identified as “Wet Rock Outcrop” wetlands, which are a subset of the “Wet Prairie”, and both wetland types are classified as ARSC under Oregon Administrative Rules (OAR) 141-085-510(3).

Table 2
Wetlands and Other Waters Delineated on the Project Site

Wetlands	Classification		Total Area	
	Cowardin Classification System ¹	Oregon HGM Classification System ²	Square Feet	Acres
Wetland A	PSSF	Slope	1,738	0.04
Wetland B	PFOE	Slope	200,288	4.6
Wetland C	PFOE	Slope	57,775	1.33
Wetland D	PFOE	Slope	39,025	0.89
Wetland E	PFOE	Slope	9,057	0.21
Wetland F	PEME	Depressional	1,018	0.02
Wetland G	PEME	Depressional	2,554	0.06
Wetland H	PEMC	Depressional	423	0.01
Wetland I	PEMC	Depressional	70	0.002
Wetland J	PEMC	Depressional	52	0.001
Wetland K	PEMC	Depressional	229	0.005
Wetland L	PEMC	Depressional	2,168	0.05
Wetland M	PFOE/PEMC	Depressional Outflow	308,405	7.08
Wetland N	PFOE	Depressional Outflow	105,960	2.43
Wetland O	PEMC	Depressional	2,571	0.06
Wetland P	PEMC	Depressional	110	0.002
Wetland Q	PEMC	Depressional	196	0.004
Wetland R	PEMC	Depressional	183	0.004
Wetland S	PEMC	Depressional	11	0.0002
Wetland T	PEMC	Depressional	3,624	0.08
Wetland U	PEMC	Depressional	1,723	0.04

Wetland Z	PFOE	Depressional	6,719	0.15
Wetland AA	PFOE	Depressional	9,700	0.22
Wetland BB	PFOE	Depressional	1,679	0.04
Wetland CC	PFOE	Depressional	10,981	0.25
Wetland DD	PFOE	Depressional	4,356	0.1
Wetland EE	PFOE	Depressional	16,117	0.37
Wetland FF	PFOE	Depressional	12,081	0.28
Wetland OO	PEMC	Depressional Outflow	1,243	0.03
Wetland PP	PEMC	Depressional Outflow	547	0.01
Wetland QQ	PEMC	Depressional Outflow	4,431	0.1
Wetland RR	PEMC	Depressional Outflow	1,329	0.03
Wetland TT	PEMC	Depressional Outflow	311	0.01
Wetland SS	PEMC	Depressional Outflow	25	0.01
Wetland XX	PEMC	Depressional Outflow	96	0.01
Wetland YY	PEMC	Depressional Outflow	996	0.02
Wetland ZZ	PFOE	Depressional	2,380	0.05
Wetland 1-A	PEME	Slope	1,077	0.025
Total Wetland Area			811,607	18.62

Notes:

1. *Classification of Wetlands and Deepwater Habitats of the United States* (Cowardin classification system; Cowardin et al. 1979) wetland codes:
PEMC: palustrine emergent, seasonally flooded wetland
PEME: palustrine emergent, seasonally flooded/saturated wetland
PFOE: palustrine forested, seasonally flooded/saturated wetland
PSSF: palustrine scrub-shrub, semipermanently flooded wetland
R4RB1: riverine, intermittent, rock bottom, bedrock
2. *Guidebook for Hydrogeomorphic (HGM)-Based Assessment of Oregon Wetland and Riparian Sites: Statewide Classification and Profiles* (Oregon HGM classification system; Adamus 2001).
3. DSL has determined that these wetlands and other waters are non-jurisdictional under the Oregon Removal-Fill Law per the wetland delineation concurrence letter for WD #2019-0623, which was issued to the Applicant on October 15, 2020 (DSL 2020).

Wetland A

Wetland A is a 1,738-square-foot (0.04-acre) palustrine scrub-shrub semipermanently flooded (PSSF)/slope wetland. It is located along the northeastern boundary of the project site. Hydrology is from surface flows and enters via a road culvert under Liberty Hill Road at the north end of the wetland. Dominant vegetation includes common snowberry (*Symphoricarpos albus*, facultative upland [FACU]) and mint (*Stachys* spp., facultative [FAC]), and reed canarygrass (*Phalaris arundinacea*, facultative wetland [FACW]). Wetland A exhibited strong hydric soil indicators consisting of a depleted matrix and multiple wetland hydrology indicators including surface water, a high perched water table, and saturation in the upper 12 inches of the soil column.

Wetland B

Wetland B is a 200,288-square-foot (4.6-acre) palustrine forested seasonally flooded/saturated (PFOE)/slope wetland with a *Guidebook for Hydrogeomorphic (HGM)-Based Assessment of Oregon Wetland and Riparian Sites: Statewide Classification and Profiles* (Oregon HGM classification system; Adamus 2001) classification of Slope. It is located southwest of Wetland A in the north-central portion of the project site. Wetland B consists of a broad swale at its north end that tapers to a more narrow and confined drainage to the southwest. There is some standing water during the winter months, although most surface water flows through and exits to the southwest. There is no defined bed and bank and no indicators of flow (e.g., sediment deposits, drift deposits, drainage patterns) between Wetlands A and B. Dominant vegetation includes Oregon ash (*Fraxinus latifolia*, FACW), willows (*Salix* spp., FAC to FACW), Oregon white oak (*Quercus garryana*, FACU), snowberry, lamp rush (*Juncus effusus*, FACW), velvet grass (*Holcus lanatus*, FAC), and reed canarygrass. Hydric soil indicators include redox dark surface, hydrogen sulfide, 2-centimeter muck, and loamy mucky mineral. Wetland hydrology indicators include oxidized rhizospheres along living roots, frost heave hummocks, a high perched water table, saturation, drift deposits, water-stained leaves, drainage patterns, geomorphic position, and the FAC-neutral test.

Wetland C

Wetland C is a 57,775-square-foot (1.33-acre) PFOE/slope wetland. It is located southwest of Wetland B in the west-central portion of the project site. Hydrology is from overland flows from Wetland B during winter storms as well as from direct precipitation and sheet flow from upslope areas. A restrictive basalt layer induces ponding. Dominant vegetation includes western arborvitae (*Thuja plicata*, FAC), Oregon ash, Himalayan blackberry (*Rubus armeniacus*, FAC), and taper-fruit short-scale sedge (*Carex leptopoda*, FAC). Hydric soil indicators include hydrogen sulfide, loamy mucky mineral, and redox dark surface. Wetland hydrology indicators include surface water, a high perched water table, saturation, water marks, water-stained leaves, hydrogen sulfide odor, drainage patterns, geomorphic position, and the FAC-neutral test.

Wetlands D and E

Wetlands D and E are PFOE/slope wetlands and are 39,025 square feet (0.89 acre), and 9,057 square feet (0.21 acre) in size, respectively. Wetlands D and E are located in the central portion of the project site and are connected to one another by a culvert that flows under a site access road. Both wetlands appear to have a subsurface hydrological connection to Wetland B. Hydrology is mainly from upslope sources and direct precipitation, both of which result in ponding within the wetlands due to the underlying restrictive basalt layer. Dominant vegetation includes Oregon ash, snowberry, willow herb (*Epilobium ciliatum*, FACW), reed canarygrass, buttercup (*Ranunculus* spp., FACU to obligate [OBL]), and trailing blackberry (*Rubus ursinus*, FACU). Wetland hydrology indicators include loamy mucky mineral and depleted matrix. Although a few areas in Wetlands D and E lacked hydric soil indicators; they were included as wetlands based on best professional judgement (BPJ) because they were observed to be inundated well into the growing season. Wetland hydrology indicators include sparsely vegetated concave surface, geomorphic position, FAC-neutral test, algal mats, and surface soil cracks.

Wetlands F and G

Wetlands F and G are palustrine emergent seasonally flooded/saturated (PEME)/depressional wetlands that are approximately 1,018 square feet (0.02 acre), and 2,554 square feet (0.06 acre) in size, respectively. They are located to the northeast and upslope of Wetland B in the northern portion of the project site. Both Wetlands F and G occur on a slope oriented to the southeast that was observed to be saturated during the rainy season. The dominant vegetation is reed canarygrass. Oregon ash, English hawthorn (*Crataegus monogyna*, FAC), and sweet vernal grass (*Anthoxanthum odoratum*, FACW) are dominant at the margins of the wetlands. Hydric soil indicator present include redox dark surface, and wetland hydrology indicators include oxidized rhizospheres along living roots, geomorphic position, and the FAC-neutral test.

Wetlands H, I, J, and K

Wetlands H, I, J, and K are palustrine emergent seasonally flooded (PEMC)/depressional wetlands location along the northeastern boundary of the project site adjacent to the main site access road. These wetlands are approximately 423 square feet (0.01 acre), 70 square feet (0.002 acre), 52 square feet (0.001 acre), and 229 square feet (0.005 acre) in size, respectively. All of these areas show evidence of past scraping and more recent evidence of being driven through with heavy vehicles; therefore, it can reasonably be assumed that these areas were artificially created. Dominant vegetation includes small camas (*Camassia quamash*, FACW) and velvet grass. Soils do not meet a specific indicator; however, positive indicators for hydrophytic vegetation and hydrology (water-stained leaves, FAC-neutral test, and geomorphic position) indicate a hydric soil regime (BPJ). DSL declined state jurisdiction over Wetland K, which was ruled to be exempt under OAR 141-085-0515(6).

Wetland L

Wetland L is a 2,169-square-foot (0.05-acre) PEMC/depressional wetland located in the northeastern portion of the project site. It is located in a swale on an approximately 3% slope and has shallow soils (3 inches) overlying bedrock. Dominant vegetation includes small camas and poverty rush (*Juncus tenuis*, FAC). Hydric soil indicators include hydrogen sulfide, 2-centimeter muck, and very dark shallow surface. Wetland hydrology indicators include saturation, hydrogen sulfide odor, and the FAC-neutral test. Wetland L has been identified as a wet rock outcrop wetland under OAR 141-085-510(3).

Wetland M

Wetland M is a wetland complex meeting two *Classification of Wetlands and Deepwater Habitats of the United States* (Cowardin classification system; Cowardin et al. 1979) classifications and totals 308,620 square feet (7.08 acres) in size. It is located southeast of Wetland B in the east-central portion of the project site. The northern portion of Wetland M is classified as a PFOE/depressional outflow wetland. Topographically, this portion of the wetland consists of two large depressions and two smaller ones that are connected by narrower sections of wetland. Water flows through the wetlands from north to south along a mild gradient of approximately 1% to 3%, which increases to approximately 10% as the wetland extends downslope. The depressions in the northern portion of Wetland M collect runoff from adjacent upslope areas and have a restrictive layer of basalt, which causes seasonal ponding. Excess water flows south and southeast over the basalt formation, and this southern portion of the wetland is classified as a PEMC/depressional outflow wetland. A 0.26-acre portion of Wetland M meets the definition of ARSC wetland under OAR 141-085-510(3).

In the northern portion of Wetland M, dominant vegetation includes Oregon ash, snowberry, Himalayan blackberry, Douglas spirea (*Spirea douglasii*, FACW), rose (*Rosa* spp., FACU to FAC), reed canarygrass, and tall fescue (*Schedonorus arundinaceus*, FAC). Hydric soils in this portion of the wetland meet the requirements for depleted matrix and redox dark surface. Wetland hydrology indicators include surface water, a high perched water table, saturation, water marks, sparsely vegetated concave surface, oxidized rhizospheres along living roots, water-stained leaves, the FAC-neutral test, and geomorphic position.

Dominant vegetation in the southern portion of Wetland M includes seep monkey-flower (*Mimulus guttatus*, OBL), small camas, death camas (*Zigadenus venenosus*, NOL), poverty rush, unidentified grasses, and sweet vernal grass. Soils are shallow, typically ranging from approximately 4 to 6 inches, although in some areas soil depth is greater than 12 inches and in others the soil is scoured to bedrock. Hydric soils meet the requirements for redox dark surface, and wetland hydrology indicators include a high perched water table, saturation, oxidized rhizospheres along living roots, and geomorphic position.

Wetland N

Wetland N is a 105,960-square-foot (2.43-acre) PFOE/slope wetland that is located in the eastern portion of the project site. The wetland is comprised of a large depression with a restrictive layer of basalt that collects runoff from adjacent upslope areas. There is a drainage at its south end that conveys flows southward and eventually dissipates before reaching the eastern escarpment. Dominant vegetation in the wetland includes Oregon ash, four-line honeysuckle (*Lonicera involucrata*, FAC), Douglas spirea, rose, and reed canarygrass. No typical hydric soil indicators are present, and therefore, wetland hydrology was determined based on a hydric moisture regime (BPJ). Wetland hydrology indicators include surface water, a high perched water table, saturation, geomorphic position, and the FAC-neutral test.

Wetlands O, P, Q, R, and S

Wetlands O, P, Q, R, and S are PEMC/depressional wetlands located in the west-central portion of the project site. These wetlands are 2,571 square feet (0.06 acre), 110 square feet (0.002 acre), 196 square feet (0.004 acre), 183 square feet (0.004 acre), and 11 square feet (0.0002 acre) in size, respectively. They occur adjacent to a site access road. Dominant vegetation includes popcorn flower (*Plagiobothrys* spp., FAC) and small camas. Hydric soil indicators include redox dark surface, and wetland hydrology indicators include oxidized rhizospheres along living roots, the FAC-neutral test, and geomorphic position. Wetlands O, P, Q, R and S have been identified as wet rock outcrop wetlands under OAR 141-085-510(3).

Wetlands T and U

Wetlands T and U are PEMC/depressional wetlands that are 3,624 square feet (0.08 acre), and 1,723 square feet (0.04 acre) in size, respectively. These wetlands are located east of Wetland M in the east-central portion of the project site. Both wetlands lie on a mild slope over bedrock in a location where runoff is concentrated. Dominant vegetation is small camas. Hydric soil indicators include redox dark surface and very shallow dark surface. Wetland hydrology indicators include a high perched water table (perched on bedrock), saturation, sparsely vegetated concave surface, oxidized rhizospheres along living roots, geomorphic position, and the FAC-neutral test. Wetlands T and U have been identified as wet rock outcrop wetlands under OAR 141-085-510(3).

Wetland Z

Wetland Z is a 6,719-square-foot (0.15-acre) PFOE/depressional wetland located west of Wetland M in the central portion of the project site. Dominant vegetation in the wetland includes Oregon ash and colonial bentgrass (*Agrostis capillaris*, FAC). Hydric soils meet the requirements for redox dark surface, and wetland hydrology indicators include oxidized rhizospheres along living roots, geomorphic position, and the FAC-neutral test.

Wetland AA

Wetland AA is a 9,700-square-foot (0.22-acre) PFOE/depressional wetland located in the central portion of the project site, west of Wetland M. It occurs within a broad, linear drainage that was blocked long ago at its west end by construction of an access road. The area surrounding the wetland shows evidence of logging, which has reduced shade cover, but the wetland is otherwise undisturbed. Dominant hydrophytic vegetation includes balsam poplar (*Populus trichocarpa*, FAC), Oregon ash, and slough sedge (*Carex obnupta*, OBL). Hydric soils meet the requirements for 2-centimeter muck and histic epipedon. Wetland hydrology indicators include high perched water table, saturation, algal mat, geomorphic position, and the FAC-neutral test.

Wetland BB, CC, DD, EE, and FF

Wetlands BB, CC, DD, EE, and FF are PFOE/depressional wetlands located in the south-central portion of the project site in shallow swales that are oriented northeast to southwest. These wetlands are 1,679 square feet (0.04 acre), 10,981 square feet (0.25 acre), 4,603 square feet (0.10 acre), 16,362 square feet (0.37 acre), and 12,081 square feet (0.28 acre), respectively. All were observed to be inundated during the winter and early spring months but did not appear to have surface connections to one another, although there may be overland flows during and following major storm events. All of the wetlands show some evidence of disturbance from logging within the past decade, including removal of Douglas fir (*Pseudotsuga menziesii*; FACU) trees, slash piles, and ground disturbance; however, none of these disturbances affected the delineation of the wetland boundaries. Ground disturbance and the removal of shade cover have favored the recruitment of some weedy species including Himalayan blackberry and Canadian thistle (*Cirsium arvense*, FAC), both within wetlands and in the adjacent uplands.

Wetland OO, PP, QQ, RR, SS, TT, XX, and YY

Wetlands OO, PP, QQ, RR, SS, TT, XX, and YY are small PEMC/depressional outflow wetlands scattered throughout the central and eastern portions of the project site. They are approximately 1,243 square feet (0.03 acre), 547 square feet (0.01 acre), 4,431 square feet (0.1 acre), 1,329 square feet (0.03 acre), 311 square feet (0.007 acre), 25 square feet (0.001 acre), 96 square feet (0.002 acre), 996 square feet (0.02 acre), and 2,380 square feet (0.05 acre) in size, respectively. Dominant vegetation consists of small camas, rushes, unidentified grasses, and western buttercup (*Ranunculus repens*, FAC). These wetlands have shallow, dark soils overlying bedrock and therefore meet the requirements for shallow dark surface. Wetland hydrology indicators include surface water, saturation, shallow aquitard, geomorphic position, and the FAC-neutral test. Of these areas, Wetlands OO, PP, QQ, RR, SS, and XX have been identified as rock outcrop wetlands under OAR 141-085-510(3).

Wetland ZZ

Wetland ZZ is a 2,380-square-foot (0.055-acre) PFOE/depressional wetland located in the central portion of the project site. It occurs in an area that was logged several years ago and includes multiple piles of slash consisting of Oregon ash and Douglas fir within and adjacent to its boundaries. Dominant vegetation includes Oregon ash, bent grasses (*Agrostis* spp., FACU to FACW), Douglas spirea, and sedges (*Carex* spp., FACU to OBL). Hydric soils meet the requirements for redox dark surface and 2-centimeter muck. Hydrology was confirmed by evidence of seasonal ponding.

Wetland 1-A

Wetland 1-A is a 1,077-square-foot (0.025-acre) PEM/slope wetland located in a small draw that slopes from northwest to southeast in the northeastern portion of the project site. It is an herbaceous wetland dominated by reed canarygrass (FACW), bluegrass (FAC), Canada thistle (FAC), and soft rush (FACW), with a minor scrub-shrub component of Himalayan blackberry (FAC). Hydric soils meet the requirements for depleted dark surface. Hydrology was confirmed by evidence of surface saturation with secondary indicators of FAC-neutral test and drainage patterns.

Perennial Stream 1-A

Perennial Stream 1-A is a 407-square-foot (0.009-acre) lower perennial, unconsolidated bottom stream (R2UBH) with and HGM classification of riverine. Perennial Stream 1-A appears to originate on slopes north of the project site, crossing under Liberty Hill Road within two concrete culverts before entering the project site. The stream flows southeast into previously delineated Wetland A, then turns south and exits Wetland A, where it continues to the southeast. Perennial Stream 1-A has a defined bed and bank throughout this area but loses bed and bank southeast of Wetland A and sheet flows during high water

events and appears to go subsurface during low flow events. The surface and subsurface flows appear to eventually resurface at previously delineated Wetland M and contributes to the hydrologic source of that wetland. Streamside vegetation is primarily snowberry (*Symphoricarpos albus*) and reed canarygrass.

Intermittent Streams B and C

Intermittent streams B and C are riverine, intermittent, rock bottom, bedrock streams (R4RB1) that are approximately 2,481 square feet (0.06 acre), and 104 square feet (0.002 acre) in size, respectively. Intermittent Stream B is located in the southern end of Wetland M and includes an intermittent tributary that extends to the north. It flows off site to the southeast, eventually flowing over the edge of bluff as a waterfall. Intermittent Stream C is located in the southern portion of Wetland QQ. It flows toward the southeast as an open channel for about 50 feet then disappears into the subsurface within that wetland. In both of these streams, seasonal flows have stripped the thin soils of the basalt bluff to bedrock, creating sharply defined channels. These streams are located on slopes of <10.5% and for the most part lack vegetation. Both of these streams drain into a series of ditches and small drainages that ultimately discharge to the Columbia River.

Ephemeral Streams B, C, D, and 1-A

Ephemeral streams B, C, D, and 1-A are located in various places within the project site and are 215 square feet (0.005 acre), 47 square feet (0.001 acre), 61 square feet (0.001 acre), and 141 square feet (0.003 acre) in size, respectively. Ephemeral Stream B is located at the northwestern portion of the project site at the southwestern end of Wetland B and connects that wetland with Wetland TT. Ephemeral Streams C and D are located in the southeastern portion of the project site. Ephemeral Stream C extends from the eastern portion of Wetland U to an unpaved access road, and Ephemeral Stream D extends east from the same access road and drains into the northwestern portion of Wetland PP; neither stream conveys flow outside of the project area. All of these streams are located on slopes of <10.5% and for the most part lack vegetation, although wetlands are adjacent in some areas. Vegetation within and adjacent to these streams mostly consisted of grasses that were not identifiable in the spring. Species were identified in summer and dominants were common velvet grass, sweet vernal grass, rough cat's ear (*Hypochaeris radicata*, FACU), and English plantain (*Plantago lanceolata*, FACU) and therefore are classified as ephemeral. Much of the channels of Ephemeral Streams C and D are scoured to bedrock. Ephemeral Stream 1-A originates from a seep upslope (northwest) of Wetland 1-A and flows into Wetland 1-A. The streambed becomes less defined once it enters Wetland 1-A and does not exit Wetland 1-A. Upslope of Wetland 1-A, vegetation on either side of the stream channel is primarily Himalayan blackberry and sword fern (*Polystichum munitum*). Once Ephemeral Stream 1-A enters Wetland 1-A, vegetation is primarily reed canarygrass.

Functions and Values Assessment

In accordance with agency administrative rules, both pre- and post-project functions and values assessments were performed for all wetlands and streams that will be impacted by the proposed project and presented in a functions and values report (Attachment K). These assessments document the functions and values currently being provided by the wetlands and stream on the project site and the anticipated functions and values losses that could result from the project. The latter is used to help identify appropriate compensatory mitigation. A copy of the assessment report that includes the wetland and stream functions and values scores and associated assessment data forms is provided in Attachment K.

Wetland Assessment Methods

The wetland functions and values assessments were conducted using the Oregon Rapid Wetland Assessment Protocol (ORWAP) in accordance with the methods presented in *Manual for the ORWAP – Version 3.1*. (Adamus et al. 2016) and the supporting website provided by Oregon Explorer ORWAP Map Viewer (Oregon Explorer 2020). Using those methods, the wetlands on the project site were assessed for their ability to provide a total of 15 different functions and 14 associated values that are grouped in the following functional groups:

- Hydrologic functions
- Water quality support functions
- Fish habitat functions
- Aquatic habitat functions
- Ecosystem support functions

The ability of these areas to sequester carbon was also assessed, as was their value in regard to public use and recognition. Other attributes assessed include wetland sensitivity, wetland ecological condition, and wetland stressors.

For the proposed project, the 38 wetlands present within the project site were grouped into 20 separate wetland assessment areas as shown in Table 3 based on similarities in their Cowardin and HGM classifications, landscape position, and other characteristics.

Table 3
Wetland Assessment Areas Used in the Oregon Rapid Wetland Assessment Protocol Functions and Values Assessment

Wetland Assessment Area	Wetlands Included in Assessment Area
1	Wetland A
2	Wetlands B and TT
3	Wetland C
4	Wetlands D and E
5	Wetlands F and G
6	Wetlands H, I, J, and K
7	Wetland M
8	Wetland N
9	Wetlands L, SS, and XX
10	Wetlands O through T, and Wetlands QQ and RR
11	Wetland U
12	Wetland Z
13	Wetland AA
14	Wetland BB
15	Wetland CC
16	Wetland DD
17	Wetlands EE and FF
18	Wetland PP
19	Wetland YY
20	Wetland ZZ
21	Wetland OO

The pre- and post-project ORWAP assessment results for the wetland assessment area are discussed in the following sections. Pre-project assessment results were based on existing site conditions; post-project assessment results were based on the expected conditions in these wetlands following implementation of the proposed project. Details on these results including the data collection and scoring/rating summary tables are provided in the functions and values report included in Attachment K.

Pre-Project Wetland Assessment Results

Most wetland assessment areas received their highest scores for providing hydrologic functions and water quality support. Exceptions for this include Assessment Area 1 (Wetland A), Assessment Area 2 (Wetlands B and TT), Assessment Area 3 (Wetland C), Assessment Area 4 (Wetlands D and E), Assessment Area 7 (Wetland M), Assessment Area 8 (Wetland N), Assessment Area 9 (Wetlands L, SS, and XX), Assessment Area 11 (Wetland U), Assessment Area 18 (Wetland PP), Assessment Area 19 (Wetland YY), and Assessment Area 21 (Wetland OO), which received more moderate to low scores for hydrologic and water quality functional groups. None of the assessment areas are suitable for providing fish habitat based on all receiving lower scores for that group of functions due to the lack of permanent inundation.

All assessment areas are providing high functioning aquatic habitat for amphibians, reptiles, and waterbirds based on all receiving higher scores for this functional group. Most assessment areas are also best at providing ecosystem support, with all receiving higher scores for this functional group except for Assessment Area 5 (Wetlands F and G), Assessment Area 6 (Wetlands H, I, J, and K), Assessment Area 10 (Wetlands O through T, QQ, and RR), Assessment Area 19 (Wetland YY), and Assessment Area 21 (Wetland OO), which received more moderate scores.

Regarding the values of these functional groups, the hydrologic functions and water quality support groups scored the highest for all assessment areas. The aquatic habitat group had lower to moderate value scores due to the limited need for permanent inundated areas to support amphibians and reptiles and waterbirds with the ample presence of permanently ponded areas in the vicinity, such as along the Columbia River. The ecosystem support group had lower value scores for all assessment areas except for Assessment Area 7 (Wetland M), Assessment Area 10 (Wetlands O through T, QQ, and RR), and Assessment Area 18 (Wetland PP), which received higher scores for this functional group. For the fish habitat group, all assessment areas received low scores for the values of these functions due to the lack of permanent inundation.

For carbon sequestration, most assessment areas are providing this function at moderate levels, except for Assessment Area 4 (Wetlands D and E), Assessment Area 9 (Wetlands L, SS, and XX), Assessment Area 10 (Wetlands O through T and Wetlands QQ and RR), Assessment Area 11 (Wetland U), Assessment Area 18 (Wetland PP), Assessment Area 19 (Wetland YY), and Assessment Area 21 (Wetland OO), which are providing this function at a lower level. For the other attributes of Wetland Sensitivity, Wetland Ecological Condition, and Wetland Stressors, all assessment areas received moderate to lower scores, except for Assessment Area 7 (Wetland M), Assessment Area 9 (Wetlands L, SS, and XX), and Assessment Area 10 (Wetlands O through T and Wetlands QQ and RR). These three assessment areas received a higher rating for the wetland sensitivity attribute, due to containing the native wet prairie wetland type. Assessment Area 11 (Wetland U) and Assessment Area 19 (Wetland PP), which are also native wet prairie wetland types, both had a rating proximity break of “MH” for the Sensitivity attribute, indicating a close proximity break between the moderate and higher ratings. All assessment areas received low value scores for the Public Use and Recognition function due to limited public access and use for recreation or consumption (e.g., fishing, hunting).

Post-Project Wetland Assessment Results

Under post-project conditions (i.e., the expected future condition of the project site), all wetland assessment areas within the proposed mining site would cease to exist. Therefore, those areas would no longer perform any wetland functions or provide values for those functions.

For the existing wetlands, enhanced wetlands, and the remaining portions of Wetland M outside of the mining footprint, all are predicted to perform at similar levels or better compared to pre-project conditions for all functional groups, and the values of those functions are also anticipated to be similar or higher. Likewise, the created wetlands are designed to function and provide values for those functions at levels commensurate with pre-project conditions. The results of the ORWAP functions and values assessments for these wetland assessment areas under post-project conditions are presented in the compensatory mitigation plan (Attachment D) and the functions and values report (Attachment K).

Stream Assessment Methods

The stream function assessment was conducted using the Oregon Stream Function Assessment Method (SFAM) in accordance with the methods presented in *Stream Function Assessment Method for Oregon Version 1.0* (Nadeau et al. 2018a) and the supporting scientific rationale provided in *Scientific Rationale in Support of the Stream Function Assessment Method for Oregon Version 1.0* (Nadeau et al. 2018b). SFAM divides stream functions into four categories—hydrologic, geomorphic, biological, and water quality functions—with a suite of 11 specific stream functions included under these categories (Nadeau et al. 2018a). Each stream function is assigned one or more of 17 stream measures of function and 16 stream measures of value, which are metrics that allow a quantitative or qualitative assessment of specific attributes that may indicate the extent to which a particular function is active (Nadeau et al. 2018b). Streams are intended to be assessed by evaluating the degree to which they perform or provide these metrics. Completion of the assessment involves both an in-office review of existing natural resource information and the collection of stream data in the field.

The assessment areas for the stream functions and values assessment included Intermittent Stream B, the Tributary to Intermittent Stream B, off-site Intermittent Stream D, and Perennial Stream 1-A (Figures 5, 6b, 6c, and 6e). Because Intermittent Stream C is contained entirely within the boundaries of Wetland QQ, it was not included under the SFAM method and was instead assessed under the ORWAP method as part of Wetland QQ. The ephemeral streams on the site were assessed as part of the wetlands that they connect to under ORWAP.

Pre-Project Stream Assessment Results

The detailed results of the SFAM functions and values assessments under pre-project (i.e., existing) conditions are summarized in the attached wetland and stream functions and values assessment report (Attachment K). Perennial Stream 1-A received higher scores for all functional groups except for the biologic functional group, which received a more moderate score. Value scores for Perennial Stream 1-A were higher for the hydrologic functional group, moderate for the geomorphic and biologic functional groups, and lower for the water quality functional group. Intermittent Stream B received higher scores for all functional groups and similar value scores for those functions as Perennial Stream 1-A. The Tributary to Intermittent Stream B received higher scores for the hydrologic and geomorphic functional groups and moderate scores for the biologic and water quality functional groups. The value scores for those functions ranged from higher to lower. Intermittent Stream D received higher scores for the geomorphic and water quality functional groups and moderate scores for the hydrologic and biologic functional groups. The value scores for those functions ranged from high to moderate.

Post-Project Stream Assessment Results

The streams that would be impacted by the proposed project would be either completely removed via overburden excavation and aggregate extraction or would have their primary hydrology source (surface runoff) altered by changes in the upstream topography. As such, they would not exist once the project is implemented and would no longer provide any post-project functions and values.

The created Perennial Stream MS-1 is predicted to perform at similar levels or better compared to pre-project conditions for all functional groups of Intermittent Streams 1-A and B, Tributary to Intermittent Stream B, Intermittent Stream D, and Perennial Stream 1-A. The results of the SFAM functions and values assessments under post-project conditions are presented in the compensatory mitigation plan (Attachment D) and the functions and values report (Attachment K).

Protected, Rare, and Sensitive Species – Salmonids

Although there are no fish-bearing streams present in the project site, the potential effects of the proposed project on Endangered Species Act (ESA)-listed salmonids and their designated Critical Habitat in downstream receiving waters (i.e., Columbia River, Milton Creek) were analyzed in a July 2020 Biological Assessment (BA) prepared for the National Marine Fisheries Service (NMFS) and the U.S. Fish and Wildlife Service (USFWS). On June 16, 2023, the USFWS requested additional analysis to support the informal consultation on bull trout and bull trout critical habitat. The USFWS received that additional information from the Applicant in a BA addendum on July 13, 2023. On August 10, 2023, the USFWS issued a determination that proposed action “may affect” but was “not likely to adversely affect” (NLAA) bull trout and bull trout critical habitat.

The action area for the BA analysis included areas that could be affected by water quality impacts from stormwater runoff and discharges from future mining operations. The action area included all of Milton Creek from the proposed action discharge point to its confluence with the Multnomah Channel (but did not include the Multnomah Channel itself). It also included the drainage network of ditches and pipes that ultimately drains directly to the Columbia River. Within that action area, the potential effects of aggregate mining on the ESA-listed salmonids and their associated Critical Habitat shown in Table 4 were analyzed.

Table 4
Endangered Species Act-Listed Species and Critical Habitat That May Occur in the Action Area

Species	DPS/ESU ¹	Status	Agency	Listing Notice	Critical Habitat
Coho salmon (<i>Oncorhynchus kisutch</i>)	LCR	Threatened	NOAA	70 FR 37160	81 FR 9251 Includes Milton Creek in action area
Steelhead (<i>O. mykiss</i>)	LCR	Threatened	NOAA	63 FR 13347 ²	70 FR 52630 None in action area
Chinook salmon (<i>O. tshawytscha</i>)	LCR	Threatened	NOAA	64 FR 14308 ³	70 FR 52630 None in action area
Chum salmon (<i>O. keta</i>)	CR	Threatened	NOAA	64 FR 14507 ²	70 FR 52630 None in action area
Bull trout (<i>Salvelinus Confluentus</i>)	CR	Threatened	USFWS	63 FR 31647	75 FR 63898 None in action area

Notes:

1. LCR = Lower Columbia River; CR = Columbia River
2. Reaffirmed in 2006 (71 FR 834)

3. Reaffirmed in 2005 (70 FR 37160)
DPS: Distinct Population Segment
ESU: Evolutionarily Significant Unit
FR: Federal Register

The analysis in the BA reached the following conclusions:

LCR Coho Salmon – May affect but is not likely to adversely affect

- The proposed action **may affect** Lower Columbia River (LCR) coho salmon for the following reasons:
 - The proposed action would discharge runoff to Milton Creek, which supports LCR coho salmon rearing, migration, and spawning.
 - Suitable habitat for LCR coho salmon is present in the action area.
 - Water quality in Milton Creek would be affected by discharges from the proposed action.
 - Drainage through the project site would be affected by recontouring of the land.
 - Mitigation would be provided by creating wetlands on the project site. Some of these wetlands would ultimately discharge to Milton Creek.
- The proposed action is **not likely to adversely affect** LCR coho salmon for the following reasons:
 - Runoff discharge locations from the proposed action are located at least 0.25 mile upstream of occupied aquatic habitat.
 - Runoff would be treated before discharging to Milton Creek tributaries, resulting in insignificant impacts on water quality in occupied aquatic habitat.
 - Quarry operations would be performed to mimic existing site drainage, resulting in insignificant impacts on hydrology in potentially occupied habitat.
 - Suitable habitat would not be affected.

Critical Habitat – The proposed action would have **no effect** on LCR coho salmon critical habitat. LCR coho salmon critical habitat is not present within the action area.

LCR Chinook Salmon – May affect but is not likely to adversely affect

- The proposed action **may affect** LCR Chinook salmon for the following reasons:
 - The proposed action would discharge runoff to Milton Creek, which may support LCR Chinook salmon rearing and migration.
 - Suitable habitat for LCR Chinook salmon is present in the action area.
 - Water quality in Milton Creek would be affected by discharges from the proposed action.
 - Drainage through the project site would be affected by recontouring of the land.
 - Mitigation would be provided by creating wetlands on the project site. Some of these wetlands would ultimately discharge to Milton Creek.
- The proposed action is **not likely to adversely affect** LCR Chinook salmon for the following reasons:
 - Runoff discharge locations from the proposed action are located at least 0.25 mile upstream of occupied aquatic habitat.
 - Runoff would be treated before discharging to Milton Creek tributaries, resulting in insignificant impacts on water quality in occupied aquatic habitat.
 - Quarry operations would be performed to mimic existing site drainage, resulting in insignificant impacts on hydrology in potentially occupied habitat.
 - Suitable habitat would not be affected.

Critical Habitat – The proposed action would have **no effect** on LCR Chinook salmon critical habitat. LCR steelhead critical habitat is not present within the action area.

Lower Columbia River Steelhead – May affect but is **not likely to adversely affect**

- The proposed action **may affect** LCR steelhead for the following reasons:
 - The proposed action would discharge runoff to Milton Creek, which supports LCR winter steelhead rearing and migration.
 - Suitable habitat for LCR winter steelhead is present in the action area.
 - Water quality in Milton Creek would be affected by discharges from the proposed action.
 - Drainage through the project site would be affected by recontouring of the land.
 - Mitigation would be provided by creating wetlands on the project site. Some of these wetlands would ultimately discharge to Milton Creek.
- The proposed action is **not likely to adversely affect** LCR steelhead for the following reasons:
 - Runoff discharge locations from the proposed action are located at least 0.25 mile upstream of occupied aquatic habitat.
 - Runoff would be treated before discharging to Milton Creek tributaries, resulting in insignificant impacts on water quality in occupied aquatic habitat.
 - Quarry operations would be performed to mimic existing site drainage, resulting in insignificant impacts on hydrology in potentially occupied habitat.
 - Suitable habitat would not be affected.

Critical Habitat – The proposed action would have **no effect** on LCR steelhead critical habitat. LCR steelhead critical habitat is not present within the action area.

Columbia Chum Salmon – May affect but is **not likely to adversely affect**

- The proposed action **may affect** Columbia River (CR) chum salmon for the following reasons:
 - The proposed action would discharge runoff to Milton Creek, which may support CR chum salmon rearing and migration.
 - Suitable habitat for CR chum salmon is present in the action area.
 - Water quality in Milton Creek would be affected by discharges from the proposed action.
 - Drainage through the project site would be affected by recontouring of the land.
 - Mitigation would be provided by creating wetlands on the project site. Some of these wetlands would ultimately discharge to Milton Creek.
- The proposed action is **not likely to adversely affect** CR chum salmon for the following reasons:
 - Runoff discharge locations from the proposed action are located at least 0.25 mile upstream of occupied aquatic habitat.
 - Runoff would be treated before discharging to Milton Creek tributaries, resulting in insignificant impacts on water quality in occupied aquatic habitat.
 - Quarry operations would be performed to mimic existing site drainage, resulting in insignificant impacts on hydrology in potentially occupied habitat.
 - Suitable habitat would not be affected.

Critical Habitat – The proposed action would have **no effect** on CR chum salmon critical habitat. CR chum salmon critical habitat is not present within the action area.

The USACE initiated ESA Section 7 consultation with NMFS prior to issuance of the March 29, 2024 AJD. It is expected that, given the results of the March 29, 2024 AJD, the USACE will withdraw consultation with NMFS.

Protected, Rare, and Sensitive Species – Terrestrial Wildlife and Plants

Potential project effects on ESA-listed terrestrial wildlife and plants were addressed in a September 2020 No Effect Letter prepared for the USFWS by Anchor QEA. The action area for that analysis included the terrestrial component that may experience environmental effects as a result of direct ground disturbance, increased noise, and visual disturbance from proposed mining operations. As shown in Table 5, the ESA-listed species addressed in this analysis include one species of mammal, three species of birds, and four plant species. As indicated in the table, the proposed action is not expected to have any effect on any of those species, primarily because they are not present on the project site and the proposed work would not affect their habitat.

**Table 5
Effect Determinations and Rationale for the Watters Quarry Phase II Project**

Species	Effect Determination	Effect Determination Rationale
Columbian White-Tailed Deer (<i>Odocoileus virginianus leucurus</i>)	NE	<ul style="list-style-type: none"> • Not present in action area • No suitable habitat present • No possibility of effects to species or habitats
Northern Spotted Owl (<i>Strix occidentalis caurina</i>)	NE	
Streaked Horned Lark (<i>Eremophila alpestris strigata</i>)	NE	
Yellow-Billed Cuckoo (<i>Coccyzus americanus</i>)	NE	
Bradshaw’s Desert Parsley (<i>Lomatium bradshawii</i>)	NE	<ul style="list-style-type: none"> • Not present in action area • No possibility of effects to species or habitats
Kincaid’s Lupine (<i>Lupinus sulphureus ssp. kincaidii</i>)	NE	
Nelson’s Checker-Mallow (<i>Sidalcea nelsoniana</i>)	NE	
Willamette Daisy (<i>Erigeron decumbens</i>)	NE	

Fish and Wildlife Use

Wildlife and observed evidence of wildlife use within the project site was documented during the several on-site investigations by Anchor QEA biologists and scientists. Resident and seasonally transient wildlife use the upland and wetland habitats within the project area for foraging, cover, and breeding.

Avian diversity throughout the project area is high due to the mix of forested, scrub-shrub, and emergent habitats within and adjacent to the on-site wetlands. Existing prairie bluffs and recent selective logging of conifers has created a patchwork of pasture-like openings and abrupt edge between the retained oak woodlands and diverse wetland habitats. Avian species observed and heard within the project area include owls, hummingbirds, game birds, birds of prey, passerines, woodpeckers, herons, and waterfowl. There were no ESA-listed avian species observed during the site visits.

Reptile and amphibian species were observed in the upland and wetland habitats on the project site. Amphibian habitat is abundant in the on-site wetlands due to the diverse hydroperiods in many of the wetlands. Movement of amphibian species between the wetlands may be limited due to the open areas dominated by invasive upland species created from past logging activities. There were no ESA-listed amphibian or reptile species observed during the site visits.

No fish species were observed within the aquatic habitats of the on-site wetlands or streams. Ponded water to support fish habitat was observed, but most of these aquatic habitats dry up seasonally and have no connectivity to other fish-bearing habitats.

Both large and small mammal species were observed in both upland and wetland habitats on the project site. Scat, burrowing mounds, and prints of coyote, deer, raccoons, opossum, voles, and moles were observed. Large snags and some cliff faces were present, but no evidence of bat species use of those habitats was observed. The project site is also used by domestic cats and domestic dogs likely from adjacent residential communities. There were no ESA-listed mammal species observed during the site visits.

B. Describe the existing navigation, fishing and recreational use of the waterbody or wetland.

None of the on-site wetlands or streams have any existing navigation, fishing, or recreational uses associated with them. These resources are all too small or isolated to support such uses.

**(7) PROJECT-SPECIFIC CRITERIA AND ALTERNATIVES ANALYSIS
(SEE ATTACHMENT H)**

Describe project-specific criteria necessary to achieve the project purpose. Describe alternative sites and project designs that were considered to avoid or minimize impacts to the waterbody or wetland.*

Project-specific criteria and the alternatives analysis and supporting exhibits are provided in Attachment H.

(8) ADDITIONAL INFORMATION

Are there state or federally listed species on the project site?	<input type="checkbox"/> Yes	<input checked="" type="checkbox"/> No	<input type="checkbox"/> Unknown
Is the project site within designated or proposed critical habitat?	<input type="checkbox"/> Yes	<input checked="" type="checkbox"/> No	<input type="checkbox"/> Unknown
Is the project site within a national Wild and Scenic River ?	<input type="checkbox"/> Yes	<input checked="" type="checkbox"/> No	<input type="checkbox"/> Unknown
Is the project site within a State Scenic Waterway ?	<input type="checkbox"/> Yes	<input checked="" type="checkbox"/> No	<input type="checkbox"/> Unknown
Is the project site within the 100-year floodplain ?	<input type="checkbox"/> Yes	<input checked="" type="checkbox"/> No	<input type="checkbox"/> Unknown
If yes to any above, explain in Block 6 and describe measures to minimize adverse effects to those resources in Block 7.			
Is the project site within the Territorial Sea Plan (TSP) Area ?	<input type="checkbox"/> Yes	<input checked="" type="checkbox"/> No	<input type="checkbox"/> Unknown
If yes, attach TSP review as a separate document for DSL.			
Is the project site within a designated Marine Reserve ?	<input type="checkbox"/> Yes	<input checked="" type="checkbox"/> No	<input type="checkbox"/> Unknown
If yes, certain additional DSL restrictions will apply.			
Will the overall project involve ground disturbance of one acre or more?	<input checked="" type="checkbox"/> Yes	<input type="checkbox"/> No	<input type="checkbox"/> Unknown
If yes, you may need a 1200-C permit from the Oregon Department of Environmental Quality (DEQ).			
Is the fill or dredged material a carrier of contaminants from on-site or off-site spills?	<input type="checkbox"/> Yes	<input type="checkbox"/> No	<input checked="" type="checkbox"/> Unknown
Has the fill or dredged material been physically and/or chemically tested?	<input type="checkbox"/> Yes	<input checked="" type="checkbox"/> No	<input type="checkbox"/> Unknown

* Not required by the Corps for a complete application but is necessary for individual permits before a permit decision can be rendered.

If yes, explain in Block 6 and provide references to any physical/chemical testing report(s).

Has a cultural resource (archaeological and/or built environment) survey been performed on the project area?	<input checked="" type="checkbox"/> Yes	<input type="checkbox"/> No	<input type="checkbox"/> Unknown
--	---	-----------------------------	----------------------------------

Do you have any additional archaeological or built environment documentation, or correspondence from tribes or the State Historic Preservation Office?	<input type="checkbox"/> Yes	<input checked="" type="checkbox"/> No	<input type="checkbox"/> Unknown
--	------------------------------	--	----------------------------------

If yes, provide a copy of the survey and/or documentation of correspondence with this application to the Corps only. Do not describe any resources in this document. Do not provide the survey or documentation to DSL.

An archaeological survey was performed on the proposed mining area by Archaeological Investigations Northwest, Inc., in March 2020. A copy of the resulting report was provided in Attachment N of the December 2020 JPA version submitted to the USACE only). The USACE initiated and completed Section 106 consultation prior to issuance of the March 29, 2024 AJD.

Is the project part of a DEQ Cleanup Site? No Yes Permit number _____ DEQ contact. _____

Will the project result in new impervious surfaces or the redevelopment of existing surfaces? Yes No

If yes, the applicant must submit a post-construction stormwater management plan as part of this application to DEQ's 401 WQC program for review and approval, see <https://www.oregon.gov/deq/FilterDocs/401wqcertPostCon.pdf>

Identify any other federal agency that is funding, authorizing or implementing the project.

Agency Name	Contact Name	Phone Number	Most Recent Date of Contact

List other certificates or approvals/denials required or received from other federal, state or local agencies for work described in this application.

Agency	Certificate / approval / denial description	Date Applied
Columbia County	Conditional Use Permit for Aggregate Mining	
Oregon Department of Environmental Quality	NPDES 1200-A General Permit	
Oregon Department of Geological and Mineral Industries	Operating Permit (Permit No. 05-0018)	

Other DSL and/or Corps Actions Associated with this Site (Check all that apply.)

Work proposed on or over lands owned by or leased from the Corps (may require authorization pursuant to 33 USC 408). These could include the federal navigation channel, structures, levees, real estate, dikes, dams, and other Corps projects.

State owned waterway

DSL Waterway Lease #:

Other Corps or DSL Permits

Corps #

DSL #

Violation for Unauthorized Activity

Corps #

DSL #

Wetland and Waters Delineation

Corps #

DSL # WD2019-0623

Submit the entire delineation report to the Corps; submit only the concurrence letter (if complete) and approved maps to DSL. If not previously submitted to DSL, send under a separate cover letter

Photographs from the 2019 delineation report and supporting 2021 memorandum are provided in Attachment I. A copy of the DSL concurrence letter is provided in Attachment J.

(9) IMPACTS, RESTORATION/REHABILITATION, AND COMPENSATORY MITIGATION

A. Describe unavoidable environmental impacts that are likely to result from the proposed project. Include permanent, temporary, direct, and indirect impacts.

Project Impact Summary

The proposed Watters Quarry Phase II project will result in the conversion of previously logged forestland to surface mining operations. Those actions would permanently impact a total of 10.14 acres of wetlands and 0.06 acre of intermittent streams in the proposed mining area (Figures 5, 6a through 6e, 7, and 8a and 8b). Indirect impacts on 1.42 acres of wetlands and 0.058 acre of intermittent streams could also occur from the alteration of hydrology. Over time, those areas may be adversely affected by hydrologic changes from the proposed project and are therefore included in the impact total (11.56 total acres). The direct and indirect impacts of the proposed project are further described in the following sections and summarized in Tables 6 and 7. Direct and indirect impacts by wetland type are summarized in Table 8.

Permanent Direct Impacts

Permanent direct impacts of the proposed project on wetlands and streams are summarized in Table 6. Overall, direct impacts would include the removal of vegetation and excavation of all soil from 10.14 acres of wetlands and 0.002 acre of intermittent streams in the proposed mining area (Figures 5, 6a through 6e, 7, and 8a and 8b). Impact cross-section locations and cross sections are shown in Figures 11 and 12a through 12d, respectively. This action would be necessary to expose the underlying basalt deposits for aggregate mining and would result in the complete loss of these wetlands and other waters and the functions and values that they provide.

Table 6
Proposed Direct Wetland and Stream Impact Areas

Feature	Cowardin Classification ¹	HGM Classification ²	Impact Area (acres)
Wetland D	PFOE	Slope	0.89
Wetland E	PFOE	Slope	0.21
Wetland H	PEMC	Depressional	0.01
Wetland I	PEMC	Depressional	0.002
Wetland J	PEMC	Depressional	0.001
Wetland K ³	PEMC	Depressional	0.005
Wetland L	PEMC	Depressional	0.05
Wetland M	PFOE/PEMC	Depressional Outflow	5.66
Wetland N	PFOE	Depressional Outflow	2.43
Wetland O	PEMC	Depressional	0.06
Wetland P	PEMC	Depressional	0.002
Wetland Q	PEMC	Depressional	0.004
Wetland R	PEMC	Depressional	0.004
Wetland S	PEMC	Depressional	0.0002
Wetland T	PEMC	Depressional	0.08
Wetland AA	PFOE	Depressional	0.22
Wetland BB	PFOE	Depressional	0.04
Wetland CC	PFOE	Depressional	0.25
Wetland QQ	PEMC	Depressional Outflow	0.1
Wetland RR	PEMC	Depressional Outflow	0.03
Wetland SS	PEMC	Depressional Outflow	0.01
Wetland XX	PEMC	Depressional Outflow	0.01
Wetland YY	PEMC	Depressional Outflow	0.02
Wetland ZZ	PFOE	Depressional	0.05
Total Wetland Direct Impacts			10.14
Intermittent Stream C	R4RB1	N/A	0.002
Total Intermittent Stream Direct Impacts			0.002

Notes:

- Cowardin classification system (Cowardin et al. 1979) wetland codes:
PEMC: palustrine emergent, seasonally flooded wetland
PEME: palustrine emergent, seasonally flooded/saturated wetland
PFOE: palustrine forested, seasonally flooded/saturated wetland
PSSF: palustrine scrub-shrub, semipermanently flooded wetland
R4RB1: riverine, intermittent, rock bottom, bedrock
- Oregon HGM classification system (Adamus 2001)
- DSL has determined that these wetlands and other waters are non-jurisdictional under the Oregon Removal-Fill Law per the wetland delineation concurrence letter for WD #2019-0623, which was issued to the Applicant on October 15, 2020 (DSL 2020).

Direct impacts by Cowardin and HGM classification are summarized in Table 8. Approximately 0.61 acre of potential wet rock outcrop wetlands, an ARSC wetland type, would be permanently lost as a result of the proposed project.

Potential Permanent Indirect Impacts

In addition to direct impacts, the proposed project may also indirectly impact approximately 1.42 acre of wetlands and 0.06 acre of intermittent streams through the disruption of surface and subsurface hydrology. Wetlands and other waters indirectly affected by the proposed project are summarized in Table 7 and would include portions of Wetland M and

Intermittent Stream B and Tributary to Intermittent Stream B that are on site but outside of the proposed mining area. Intermittent Stream D, which is located just outside of the project site, would also likely be affected by hydrology disruptions from the proposed project. All of these streams and the remaining portion of Wetland M are located downgradient from the proposed mining operation, which may disrupt the downslope movement of surface and subsurface flows that provide an important hydrology source for these areas. While some of these areas would still receive direct precipitation, it may not be sufficient to support hydrophytic plant communities. These wetlands may dry up over time such that they no longer meet wetland characteristics. Any functions and value associated with these areas may be lost.

**Table 7
Proposed Indirect Wetland and Stream Impact Areas**

Feature	Cowardin Classification ¹	HGM Classification ²	Indirect Impact Area (acres)
Wetland M	PFOE/PEMC	Depressional Outflow	1.42
Total Wetland Indirect Impacts			1.42
Intermittent Stream B	R4RB1	N/A	0.045
Tributary to Intermittent Stream B	R4RB1	N/A	0.012
Intermittent Stream D	R4RB1	N/A	0.001
Total Stream Indirect Impacts			0.058

Notes:

- Cowardin classification system (Cowardin et al. 1979) wetland codes:
PEMC: palustrine emergent, seasonally flooded wetland
PEME: palustrine emergent, seasonally flooded/saturated wetland
PFOE: palustrine forested, seasonally flooded/saturated wetland
PSSF: palustrine scrub-shrub, semipermanently flooded wetland
R4RB1: riverine, intermittent, rock bottom, bedrock
- Oregon HGM classification system (Adamus 2001)

Wetland Impact by Cowardin and HGM Wetland Type

Table 8 summarized the proposed direct and indirect impacts by Cowardin and HGM wetland types.

**Table 8
Proposed Direct and Indirect Wetland Impacts by Cowardin and HGM Type**

Cowardin/HGM Wetland Type ^{1,2}	Area (Acres)
PEMC/Depressional	0.22
PEMC/Depressional Outflow	0.17
PFOE/Depressional	0.56
PFOE/Depressional Outflow	2.43
PFOE-PEMC/Depressional Outflow	7.08
PFOE/Slope	1.10
Total	11.56

Notes:

- Cowardin classification system (Cowardin et al. 1979) wetland codes:
PEMC: palustrine emergent, seasonally flooded wetland
PEME: palustrine emergent, seasonally flooded/saturated wetland
PFOE: palustrine forested, seasonally flooded/saturated wetland
PSSF: palustrine scrub-shrub, semipermanently flooded wetland
R4RB1: riverine, intermittent, rock bottom, bedrock
- Oregon HGM classification system (Adamus 2001)

B. For temporary removal or fill or disturbance of vegetation in waterbodies, wetlands or riparian (i.e., streamside) areas, discuss how the site will be restored after construction to include the timeline for restoration.

All proposed project impacts on wetlands and other waters are considered to be permanent. When the proposed mining site is eventually restored following completion of mining activities, the site would consist of a relatively large open water lake surrounded by reclaimed uplands and the adjacent compensatory wetland mitigation site.

Compensatory Mitigation

C. Proposed mitigation approach. Check all that apply:

<input checked="" type="checkbox"/> Permittee-responsible Onsite Mitigation	<input type="checkbox"/> Permittee-responsible Offsite mitigation	<input type="checkbox"/> Mitigation Bank or In-Lieu Fee Program	<input type="checkbox"/> Payment to Provide (not approved for use with Corps permits)
---	---	---	---

D. Provide a brief description of proposed mitigation approach and the rationale for choosing that approach. If you believe mitigation should not be required, explain why.

Unavoidable impacts on wetlands resulting from the project would be mitigated on site through wetland creation (Figure 13). The mitigation goal is the successful creation and sustained ecological condition of approximately 1.30 acres of ARSC wetlands, 17.02 acres of PFO/PSS/PEM wetlands, and 1.12 acres of perennial stream. A total of 14 existing wetlands (Wetlands A, B, C, F, G, U, Z, DD, EE, FF, OO, PP, TT, and 1-A) totaling 7.14 acres and a total of 0.02 acre of existing stream (Ephemeral Streams B, C, D, and 1-A and Perennial Stream 1-A) would be avoided by the project. A copy of the compensatory mitigation plan is provided in Attachment D.

Mitigation Bank / In-Lieu Fee Information:

Name of mitigation bank or in-lieu fee project:	
Type and amount of credits to be purchased:	

If you are proposing permittee-responsible mitigation, have you prepared a compensatory mitigation plan?
 Yes. Submit the plan with this application and complete the remainder of this section.
 No. A mitigation plan will need to be submitted (for DSL, this plan is required for a complete application).

Mitigation Location Information (Fill out only if permittee-responsible mitigation is proposed)

Mitigation Site Name/Legal Description	Mitigation Site Address	Tax Lot #	
Watters Quarry Phase II Mitigation Site	No address assigned	51W32DD00100, 5N1W32001600, and 5N1W33000300	
County	City	Latitude & Longitude (in DD.DDDD format)	
Columbia	St. Helens	45.872941, -122.826478	
Township	Range	Section	Quarter/Quarter
5 North	1 West	32 and 33	D (Sec. 32); B and C (Sec. 33)

(10) ADJACENT PROPERTY OWNERS FOR PROJECT AND MITIGATION SITE

<input checked="" type="checkbox"/> Pre-printed mailing labels of adjacent property owners attached Mailing labels for adjacent property owners are provided in Attachment L	Project Site Adjacent Property Owners	Mitigation Site Adjacent Property Owners
---	--	---

Tax Lot Number(s) Contact Name Address 1 Address 2 City, ST ZIP Code	4105-AA-11200, 4104-B0-00900 WEYERHAEUSER NR COMPANY 220 OCCIDENTAL AVE S SEATTLE, WA 98104	
Tax Lot Number(s) Contact Name Address 1 Address 2 City, ST ZIP Code	5133-00-00401 FLYING F LLC PO BOX 3525 PORTLAND, OR 97231	
Tax Lot Number(s) Contact Name Address 1 Address 2 City, ST ZIP Code	5133-CD-01500 ICDC II LLC 14855 SE 82ND DR CLACKAMAS, OR 97015	
Tax Lot Number(s) Contact Name Address 1 Address 2 City, ST ZIP Code	5133-CD-01600 FLORIAN DAVIS 6950 NW KANSAS CITY RD FOREST GROVE, OR 97116	
Tax Lot Number(s) Contact Name Address 1 Address 2 City, ST ZIP Code	5133-CD-01100 JAMES S, MICHAEL S, & BONNIE LEE MAUCK 10940 SW LANCASTER RD PORTLAND, OR 97231	
Tax Lot Number(s) Contact Name Address 1 Address 2 City, ST ZIP Code	5133-CD-01000 NSA PROPERTY HOLDINGS LLC 14855 SE 82ND DR CLACKAMAS, OR 97015	
Tax Lot Number(s) Contact Name Address 1 Address 2 City, ST ZIP Code	5133-CD-01001 EASY 2 WASH LLC 460 W MARINE DR ASTORIA, OR 97103	
Tax Lot Number(s) Contact Name Address 1 Address 2 City, ST ZIP Code	5133-CD-00200, 5133-CD-00600 DAVE B & JILL A LAWRENCE 1765 7TH ST COLUMBIA CITY, OR 97018	
Tax Lot Number(s) Contact Name Address 1 Address 2 City, ST ZIP Code	5133-00-00800 COLUMBIA RIVER PUD RICK LUGAR PO BOX 1193 ST HELENS, OR 97051	

Tax Lot Number(s) Contact Name Address 1 Address 2 City, ST ZIP Code	5132-DD-00100, 5132-DD-00100 WEYERHAEUSER NR COMPANY 32260 OLD HWY 34 TANGENT, OR 97389	
Tax Lot Number(s) Contact Name Address 1 Address 2 City, ST ZIP Code	5133-00-00500 COLUMBIA COUNTY 230 STRAND ST ST HELENS, OR 97051	
Tax Lot Number(s) Contact Name Address 1 Address 2 City, ST ZIP Code	5133-00-00200 D L FREYTAG P O BOX 216 ST HELENS, OR 97051	5133-00-00200 D L FREYTAG P O BOX 216 ST HELENS, OR 97051
Tax Lot Number(s) Contact Name Address 1 Address 2 City, ST ZIP Code	5132-00-00200 WATTERS L R & WATTERS W M TESTAMENT TRT 2035 SE MAIN ST PORTLAND, OR 97231	5132-00-00200 WATTERS L R & WATTERS W M TESTAMENT TRT 2035 SE MAIN ST PORTLAND, OR 97231
Tax Lot Number(s) Contact Name Address 1 Address 2 City, ST ZIP Code	5132-00-00401 RANDALL S AND ANNA R STAMPER 32376 RED HAWK LN SCAPPOOSE, OR 97056	
Tax Lot Number(s) Contact Name Address 1 Address 2 City, ST ZIP Code	5132-00-00300 RONALD C & JANELLE L VANDOLAH 2205 BUTTERFIELD RD #SPC #210 YAKIMA, WA 98901	5132-00-00300 RONALD C & JANELLE L VANDOLAH 2205 BUTTERFIELD RD #SPC #210 YAKIMA, WA 98901
Tax Lot Number(s) Contact Name Address 1 Address 2 City, ST ZIP Code	5132-00-00403 AARON J SHIERK 2034 COLUMBIA BLVD #PMB 506 ST HELENS, OR 97051	
Tax Lot Number(s) Contact Name Address 1 Address 2 City, ST ZIP Code	5132-DB-00100 ST HELENS ASSETS LLC PO BOX 288 WASHOUGAL, WA 98671	5132-DB-00100 ST HELENS ASSETS LLC PO BOX 288 WASHOUGAL, WA 98671
Tax Lot Number(s) Contact Name Address 1 Address 2 City, ST ZIP Code	5132-DB-01400 EDWIN N & CYNTHIA A BARKER 603 WAPITI DR ST HELENS, OR 97051	5132-DB-01400 EDWIN N & CYNTHIA A BARKER 603 WAPITI DR ST HELENS, OR 97051

Tax Lot Number(s) Contact Name Address 1 Address 2 City, ST ZIP Code	5132-DB-01500 JACQUILINE M SINCLAIR 60330 WAPITI DR ST HELENS, OR 97051	5132-DB-01500 JACQUILINE M SINCLAIR 60330 WAPITI DR ST HELENS, OR 97051
Tax Lot Number(s) Contact Name Address 1 Address 2 City, ST ZIP Code	5132-DB-01600 HAZEL C MOSS 60320 WAPITI DR ST HELENS, OR 97051-3752	5132-DB-01600 HAZEL C MOSS 60320 WAPITI DR ST HELENS, OR 97051-3752
Tax Lot Number(s) Contact Name Address 1 Address 2 City, ST ZIP Code	5132-DB-01700 MEGAN FITZSIMMONS & KENNETH MCFARLAND 60310 WAPITI DR ST HELENS, OR 97051	5132-DB-01700 MEGAN FITZSIMMONS & KENNETH MCFARLAND 60310 WAPITI DR ST HELENS, OR 97051
Tax Lot Number(s) Contact Name Address 1 Address 2 City, ST ZIP Code	5132-DB-01800 ADRIAN & FELIPE VELAZQUEZ 60300 WAPITI DR ST HELENS, OR 97051	5132-DB-01800 ADRIAN & FELIPE VELAZQUEZ 60300 WAPITI DR ST HELENS, OR 97051
Tax Lot Number(s) Contact Name Address 1 Address 2 City, ST ZIP Code	5132-DB-01900 MITCHEAL ROY JENSEN 60290 WAPITI DR ST HELENS, OR 97051	5132-DB-01900 MITCHEAL ROY JENSEN 60290 WAPITI DR ST HELENS, OR 97051
Tax Lot Number(s) Contact Name Address 1 Address 2 City, ST ZIP Code	5132-DB-02000 AMANDA G & TROY A MILLER 60280 WAPITI DR ST HELENS, OR 97051	5132-DB-02000 AMANDA G & TROY A MILLER 60280 WAPITI DR ST HELENS, OR 97051
Tax Lot Number(s) Contact Name Address 1 Address 2 City, ST ZIP Code	5132-DB-02100 LARRY W & REBECCA L COOK 60270 WAPITI DR ST HELENS, OR 97051	5132-DB-02100 LARRY W & REBECCA L COOK 60270 WAPITI DR ST HELENS, OR 97051
Tax Lot Number(s) Contact Name Address 1 Address 2 City, ST ZIP Code	5132-DC-00101 ROBERT FREDERICK & SHAUNA M ECKERT 60260 WAPITI DR ST HELENS, OR 97051	5132-DC-00101 ROBERT FREDERICK & SHAUNA M ECKERT 60260 WAPITI DR ST HELENS, OR 97051
Tax Lot Number(s) Contact Name Address 1 Address 2 City, ST ZIP Code	5132-DC-00102 KIMBERLY A. LOBBY 60250 WAPITI DR ST HELENS, OR 97051	5132-DC-00102 KIMBERLY A. LOBBY 60250 WAPITI DR ST HELENS, OR 97051

Tax Lot Number(s) Contact Name Address 1 Address 2 City, ST ZIP Code	5132-DC-00103 MARK V & ROCHELLE M RUSSELL 60240 WAPITI DR ST HELENS, OR 97051	5132-DC-00103 MARK V & ROCHELLE M RUSSELL 60240 WAPITI DR ST HELENS, OR 97051
Tax Lot Number(s) Contact Name Address 1 Address 2 City, ST ZIP Code	5132-DC-00104 JOHN P LEDIAEV JR 60230 WAPITI DR ST HELENS, OR 97051	5132-DC-00104 JOHN P LEDIAEV JR 60230 WAPITI DR ST HELENS, OR 97051
Tax Lot Number(s) Contact Name Address 1 Address 2 City, ST ZIP Code	5132-DC-00105 VALERIE A HUEBNER & DAVID A SLAY 60220 WAPITI DR ST HELENS, OR 97051	5132-DC-00105 VALERIE A HUEBNER & DAVID A SLAY 60220 WAPITI DR ST HELENS, OR 97051
Tax Lot Number(s) Contact Name Address 1 Address 2 City, ST ZIP Code	5132-DC-00106 RICK & LORRI BLEVENS 60210 WAPITI DR ST HELENS, OR 97051	
Tax Lot Number(s) Contact Name Address 1 Address 2 City, ST ZIP Code	5132-DC-00107 RAYMOND & JANICE ANDREWS FAMILY TRUST 60200 WAPITI DR ST HELENS, OR 97051	

**(11) CITY/COUNTY PLANNING DEPARTMENT LAND USE AFFIDAVIT
(TO BE COMPLETED BY LOCAL PLANNING OFFICIAL)**

I have reviewed the project described in this application and have determined that:

- This project is not regulated by the comprehensive plan and land use regulations
- This project is consistent with the comprehensive plan and land use regulations
- This project is consistent with the comprehensive plan and land use regulations with the following:
 - Conditional Use Approval
 - Development Permit
 - Other Permit (explain in comment section below)
- This project is not currently consistent with the comprehensive plan and land use regulations. To be consistent requires:
 - Plan Amendment
 - Zone Change
 - Other Approval or Review (explain in comment section below)

An application or variance request has not been filed for the approvals required above.



Local planning official name (print) <i>Deborah S. Jacobs</i>	Title <i>Senior Planner</i>	City / County
Signature <i>Deborah S. Jacobs</i>	Date <i>12/12/2022</i>	

Comments:

Columbia County Planning Commission reviewed and approved CU 22-92 with conditions authorizing the Walters Quarry Expansion into the subject property currently associated with Tax Lots 5132-00-01600 and 5133-00-00400. Portions of original tax lot 5132-00-01600 are now associated with the northern portion of tax lot 5133-DD-00100 that is outside the St. Helens URB.

DOBAMI has issued Permit # 0500018 for the 1992 requested expansion.

Only the northern portion of tax lot 5133-DD-00100 is included in the 1992 expansion. This northern portion is identified ONLY as the portion that is not located within the City of St. Helens Urban Growth Boundary.

This modifies LUC 21-25 issued by Land Development Services that was also signed by Deborah S. Jacobs

(12) COASTAL ZONE CERTIFICATION

If the proposed activity described in your permit application is within the [Oregon Coastal Zone](#), the following certification is required before your application can be processed. The signed statement will be forwarded to the Oregon Department of Land Conservation and Development (DLCD) for its concurrence or objection. For additional information on the Oregon Coastal Zone Management Program and consistency reviews of federally permitted projects, contact DLCD at 635 Capitol Street NE, Suite 150, Salem, Oregon 97301 or call 503-373-0050 or click [here](#).

CERTIFICATION STATEMENT

I certify that, to the best of my knowledge and belief, the proposed activity described in this application complies with the approved Oregon Coastal Zone Management Program and will be completed in a manner consistent with the program.

Print /Type Applicant Name

Title

Applicant Signature

Date

(13) SIGNATURES

Application is hereby made for the activities described herein. I certify that I am familiar with the information contained in the application, and, to the best of my knowledge and belief, this information is true, complete and accurate. I further certify that I possess the authority to undertake the proposed activities. By signing this application I consent to allow Corps or DSL staff to enter into the above-described property to inspect the project location and to determine compliance with an authorization, if granted. I hereby authorize the person identified in the authorized agent block below to act in my behalf as my agent in the processing of this application and to furnish supplemental information in support of this permit application. I understand that the granting of other permits by local, county, state or federal agencies does not release me from the requirement of obtaining the permits requested before commencing the project. I understand that payment of the required state processing fee does not guarantee permit issuance. To be considered complete, the fee must accompany the application to DSL. The fee is not required for submittal of an application to the Corps.

Fee Amount Enclosed	\$999
----------------------------	-------

Applicant Signature (required) must match the name in Block 2

Print Name	Title
Jeff Steyaert	Environmental, Permitting & Property Manager

Signature	Date
	April 4, 2024

Authorized Agent Signature

Print Name	Title
Greg Summers	Principal Planner, Professional Wetland Scientist

Signature	Date
	April 5, 2024

Landowner Signature(s)***Landowner of the Project Site (if different from applicant)**

Print Name	Title
Mary Castle	Manager, Minerals West

Signature	Date
	APRIL 1, 2024

Landowner of the Mitigation Site (if different from applicant)

Print Name	Title
Mary Castle	Manager, Minerals West

Signature	Date
	APRIL 1, 2024

Department of State Lands, Property Manager (to be completed by DSL)

If the project is located on [state-owned submerged and submersible lands](#), DSL staff will obtain a signature from the Land Management Division of DSL. A signature by DSL for activities proposed on state-owned submerged/submersible lands only grants the applicant consent to apply for a removal-fill permit. A signature for activities on state-owned submerged and submersible lands grants no other authority, express or implied and a separate proprietary authorization may be required.

Print Name	Title

Signature	Date

* Not required by the Corps.

(14) ATTACHMENTS

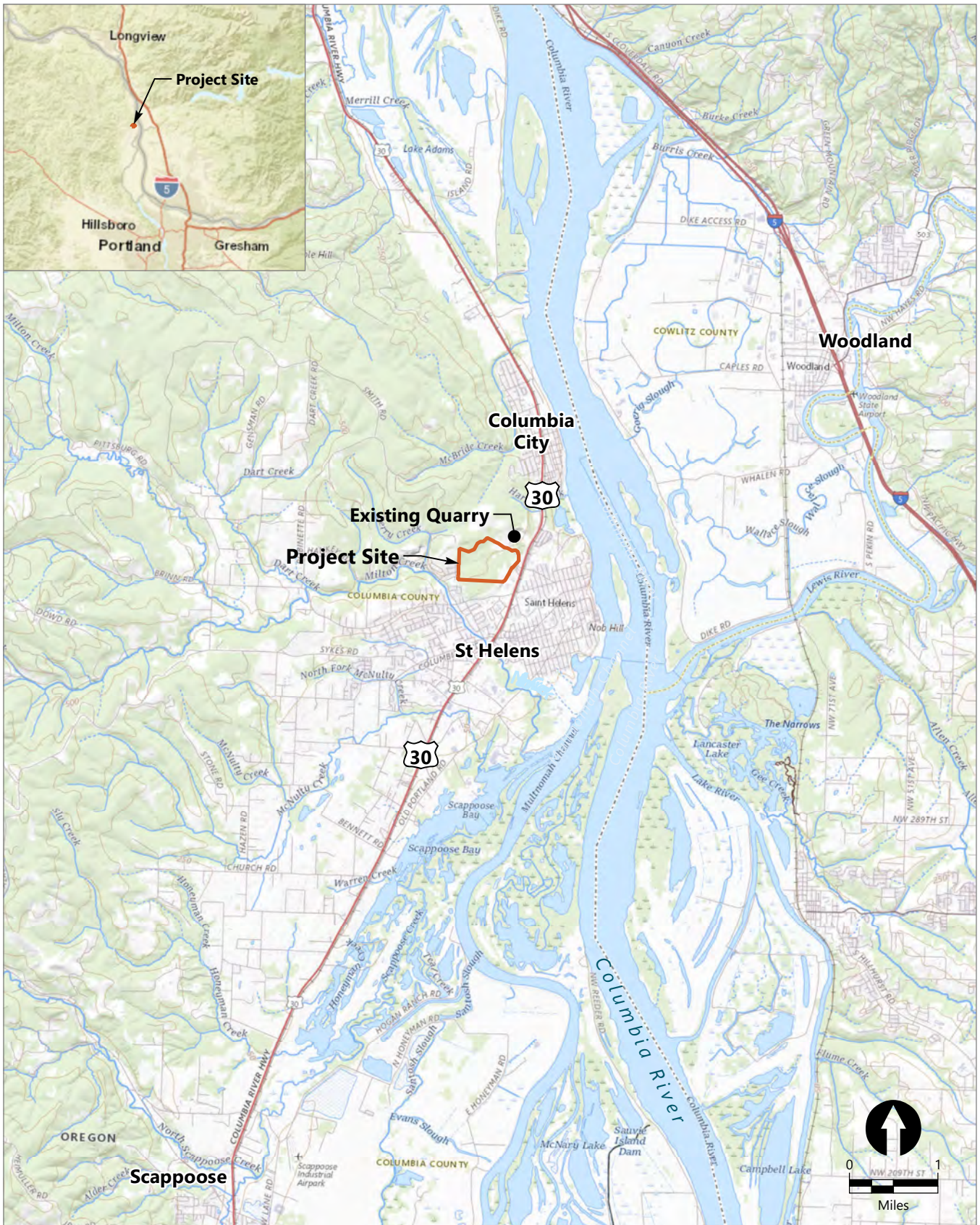
- Drawings – **Included in Figures section**
 - Location map with roads identified
 - U.S.G.S topographic map
 - Tax lot map
 - Site plan(s)
 - Plan view and cross section drawing(s)
 - Recent aerial photo
 - Project photos
 - Erosion and Pollution Control Plan(s), if applicable – **N/A**
 - DSL / Corps Wetland Concurrence letter and map, if approved and applicable – **Attachments I and J**
- Pre-printed labels for adjacent property owners (Required if more than 5) – **Attachment L**
- Incumbency Certificate if applicant is a partnership or corporation – **Attachment A**
- Restoration plan or rehabilitation plan for temporary impacts – **N/A**
- Mitigation plan – **Attachment D**
- Wetland functional assessments, if applicable – **Attachment K**
 - Cover Page
 - Score Sheets
 - ORWAP OR, F, T, & S forms
 - ORWAP Reports
 - Assessment Maps
 - ORWAP Reports: Soils, Topo, Assessment area, Contributing area
- Stream Functional Assessments, if applicable – **Attachment K**
 - Cover Page
 - Score Sheets
 - SFAM PA, PAA, & EAA forms
 - SFAM Report
 - Assessment Maps
 - Aerial Photo Site Map and Topo Site Map (Both maps should document the PA, PAA, & EAA)
- Compensatory Mitigation (CM) Eligibility & Accounting [Worksheet](#) – **Attachment C**
 - Matching Quickguide sheet(s)
 - CM Eligibility & Accounting sheet
- Alternatives analysis – **Attachment H**
- Biological assessment (if requested by the Corps project manager during pre-application coordination)
- Stormwater management plan (may be required by the Corps or DEQ) – **Attachment F**
- Other
 - Please describe: Columbia County Conditional Use Permit (Attachment B), DOGAMI Operating Permit (Attachment C), Removal Fill Volumes (Attachment E), Reclamation Plan (Attachment G).

References

- Adamus, P.R., 2001. *Guidebook for Hydrogeomorphic (HGM)-based Assessment of Oregon Wetland and Riparian Sites: Statewide Classification and Profiles*. Oregon Division of State Lands. February 2001.
- Adamus, P., K. Verble, and M. Rudenko, 2016. *Manual for the Oregon Rapid Wetland Assessment Protocol*. (ORWAP, revised). Version 3.1. Salem: Oregon Department of State Lands. November 2016. Available at: https://www.oregon.gov/dsl/WW/Documents/ORWAP_3_1_Manual_Nov_2016.pdf.
- AINW (Archaeological Investigations Northwest, Inc.), 2020. *Archaeological Survey for the Knife River Watters Quarry Project, Columbia County, Oregon*. Prepared for Anchor QEA, Portland, Oregon. Report No. 4376. March 18, 2020.
- Columbia County Planning Commission, 1995. *Order No. PAC 1-95*. In the matter of: Codifying Planning Information on Significant Aggregate Sites for the Purpose of Amending the Comprehensive Plan During Periodic Review. St. Helens, Oregon. June 23, 1995.
- Cowardin, L.M., V. Carter, F.C. Golet, and E.T. LaRoe, 1979. *Classification of Wetlands and Deepwater Habitats of the United States*. U.S. Department of the Interior – Fish and Wildlife Service. Washington, D.C.: Government Printing Office. December 1979.
- DEQ, 2016. Letter to: Eagle Star Rock Products, LLC c/o James Bruce, Registered Agent. Regarding Notice of Civil Penalty Assessment and Order, Case No: WQ/SW-NWR-2016-073. July 13, 2016.
- DSL, 2020. Letter to: Mary Castle, Weyerhaeuser. Regarding: WD #2019-0623, Approved with Revisions, Wetland Delineation Report for Watters Quarry, Columbia County; Multiple Tax Maps and Tax Lots. October 15, 2020.
- Nadeau, T-L., D. Hicks, C. Trowbridge, N. Maness, R. Coulombe, N. Czarnomski, 2018a. *Stream Function Assessment Method for Oregon (SFAM, Version 1.0)*. Oregon Dept. of State Lands, Salem, Oregon. EPA 910-D-18-001. U.S. Environmental Protection Agency, Region 10, Seattle, Washington. June 2018. Available at: <http://doi.org/10.13140/RG.2.2.36064.12806>.
- Nadeau, T-L., C. Trowbridge, D. Hicks, and R. Coulombe, 2018b. *A Scientific Rationale in Support of the Stream Function Assessment Method for Oregon (SFAM, Version 1.0)*. Oregon Department of State Lands, Salem, Oregon. EPA 910-S-18-001. U.S. Environmental Protection Agency, Region 10, Seattle, Washington. June 2018. Available at: [https://www.oregon.gov/dsl/WW/Documents/Stream_Function_Assessment_Method_\(SFAM\)_v_1.0_Scientific%20Rationale.pdf](https://www.oregon.gov/dsl/WW/Documents/Stream_Function_Assessment_Method_(SFAM)_v_1.0_Scientific%20Rationale.pdf).
- NRCS (Natural Resources Conservation Service), 2020. Web Soil Survey. Available at: <https://websoilsurvey.sc.egov.usda.gov/App/WebSoilSurvey.aspx>.
- ODOT (Oregon Department of Transportation), 2020. ODOT TransGIS. Available at: <https://gis.odot.state.or.us/transgis/>.

- Oregon Explorer, 2020. Oregon Explorer – Oregon Rapid Wetland Assessment Protocol (ORWAP) and Stream Function Assessment Method (SFAM) Map Viewer. Oregon State University Library and Institute for Natural Resources. Corvallis: Oregon State University, Available at: http://tools.oregonexplorer.info/oe_map_viewer_2_0/Viewer.html?Viewer=orwap. Accessed October 6, 2020.
- Oregon Office of Economic Analysis, 2013. *Forecasts of Oregon's County Population and Components of Change, 2010–2050*. Available at: <https://www.oregon.gov/das/OEA/Pages/forecastdemographic.aspx>.
- PHS (Pacific Habitat Services, Inc.), 2019. *Wetland Delineation for Watters Quarry, St. Helens, Oregon*. Prepared for Knife River Corporation – Northwest, Tangent, Oregon. November 11, 2019.
- PHS, 2020a. Memorandum to: Daniel Evans, Oregon Department of State Lands. Regarding: Supplemental Information Regarding the Watters Quarry Wetland Delineation; WD 2019-0623. PHS #6300. July 17, 2020.
- PHS, 2020b. Memorandum to: Daniel Evans, Oregon Department of State Lands. Regarding: Supplemental Information Regarding the Watters Quarry Wetland Delineation; WD 2019-0623. PHS #6300. August 5, 2020.
- USFWS (U.S. Fish and Wildlife Service), 2020. National Wetlands Inventory Wetland Mapper. Available at: <https://www.fws.gov/wetlands/data/mapper.html>.

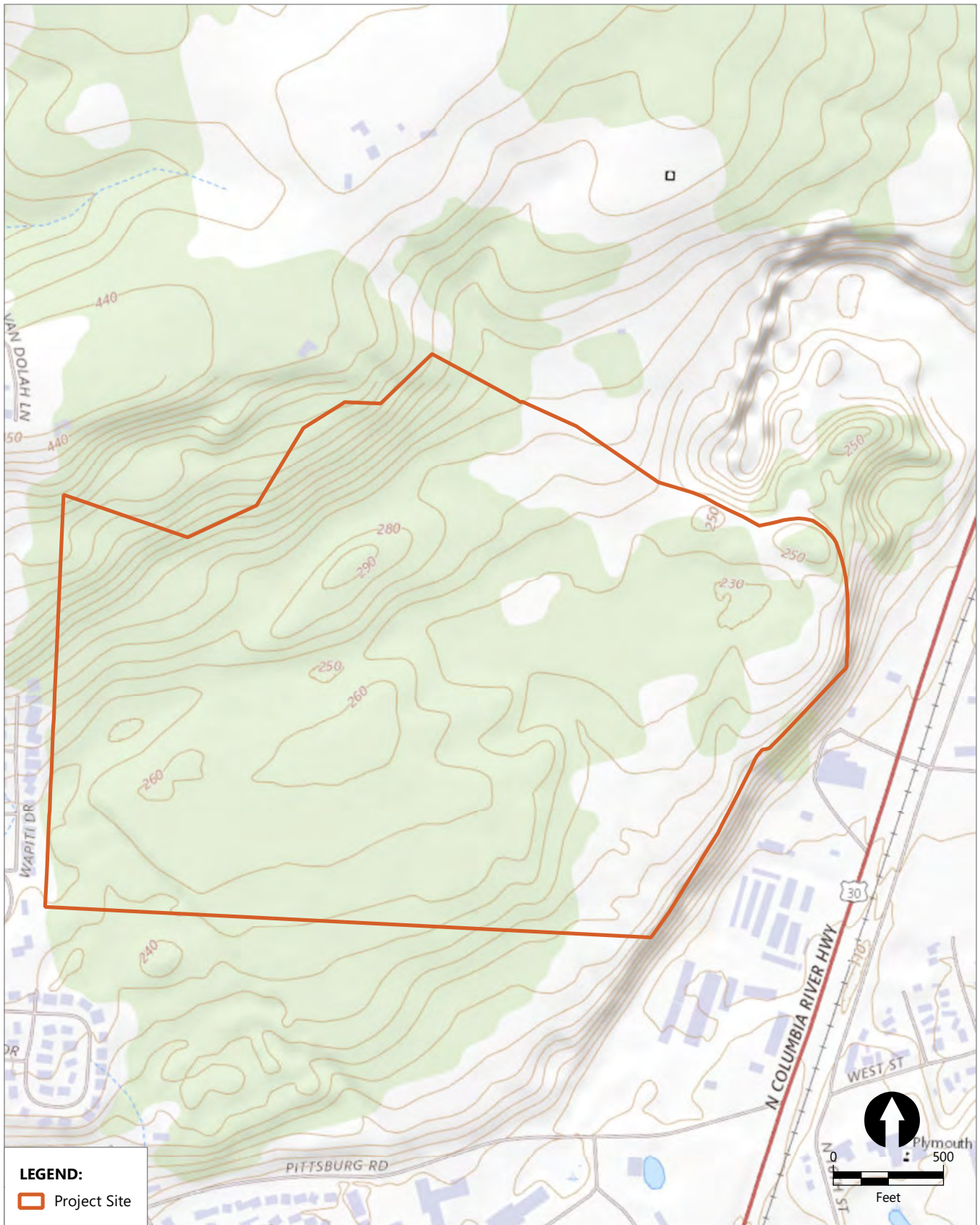
Figures



Publish Date: 2023/12/20, 12:38 PM | User: jfox
Filepath: \\orcas\GIS\Jobs\Knife_River_Corp_2114\Watters_Quarry\Maps\JPA\AQ_JPA_Fig1_Vicinity_Map.mxd



Figure 1
Vicinity Map
Joint Permit Application
Watters Quarry Phase II Project






Publish Date: 2023/12/20, 12:39 PM | User: jfox
Filepath: \\orcas\GIS\Jobs\Knife_River_Corp_2114\Watters_Quarry\Maps\JPA\AQ_JPA_Fig2_USGS_Topo_Map.mxd



Figure 2
USGS Topography Map
Joint Permit Application
Watters Quarry Phase II Project

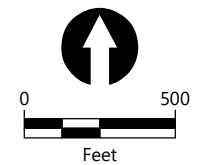


LEGEND:

-  Project Site
-  Tax Parcel
-  Proposed Mining Area

NOTES:

1. Aerial imagery: Esri (2021)
2. Tax lots sourced from Columbia County.



Publish Date: 2023/12/20, 12:44 PM | User: jfox
Filepath: \\orcas\GIS\Jobs\Knife_River_Corp_2114\Watters_Quarry\Maps\JPA\AQ_JPA_Fig3_Tax_Parcel_Map.mxd



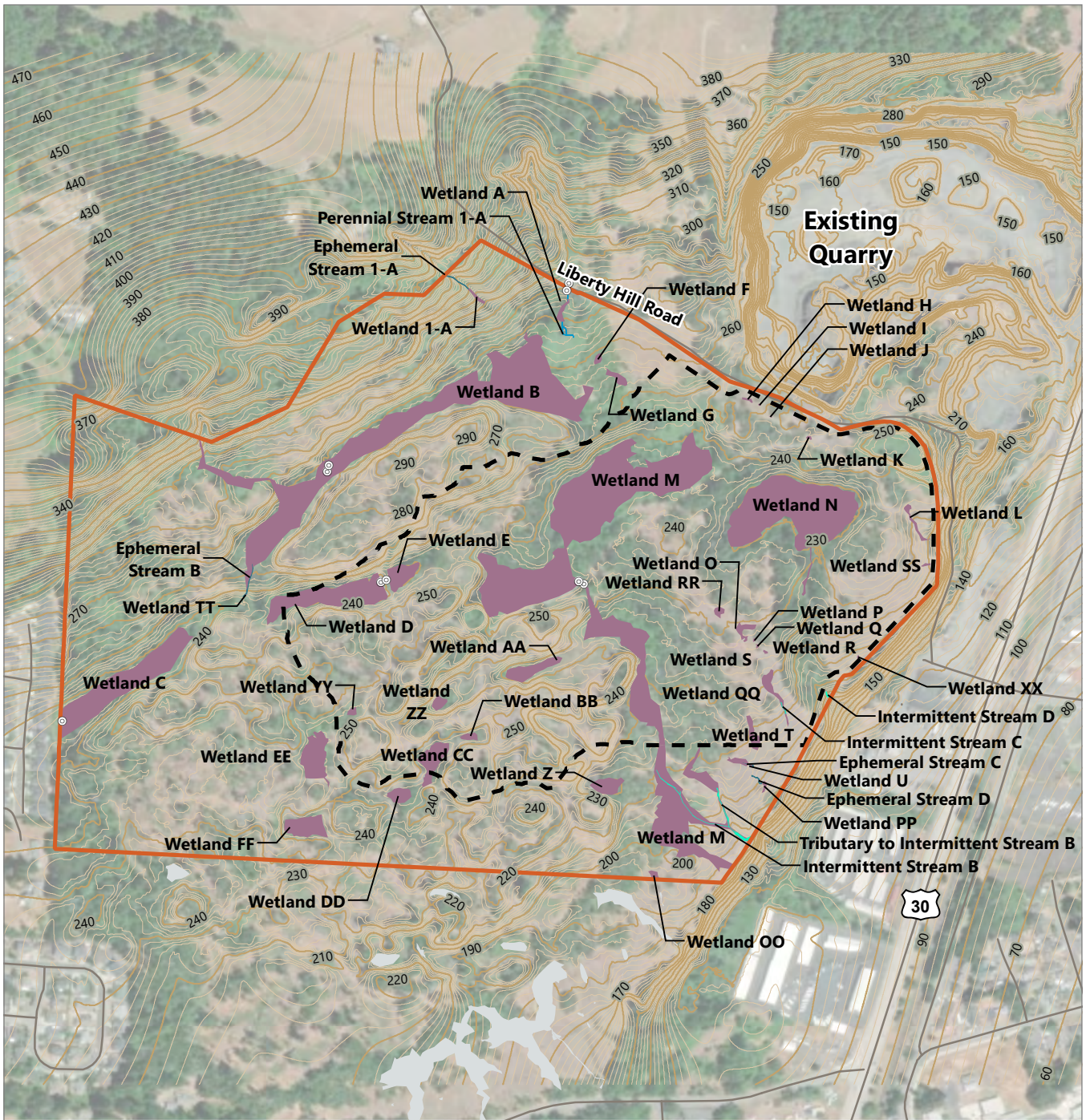
Figure 3
Tax Parcel Map
Joint Permit Application
Watters Quarry Phase II Project



Publish Date: 2023/12/20, 1:11 PM | User: jfox
Filepath: \\orcas\GIS\Jobs\Knife_River_Corp_2114\Watters_Quarry\Maps\JPA\AQ_JPA_Fig4_Aerial_Overview_Map.mxd



Figure 4
Aerial Overview Map
Joint Permit Application
Watters Quarry Phase II Project



LEGEND:

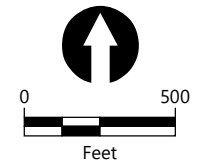
- Project Site
- Proposed Mining Area
- 10-foot Contour
- 2-foot Contour

Wetlands and Streams

- Delineated Perennial Stream
- Delineated Intermittent Stream
- Delineated Ephemeral Stream
- Delineated Wetland
- Off-site Delineated Wetlands and Streams

NOTE:

1. Aerial imagery: Esri (2021)

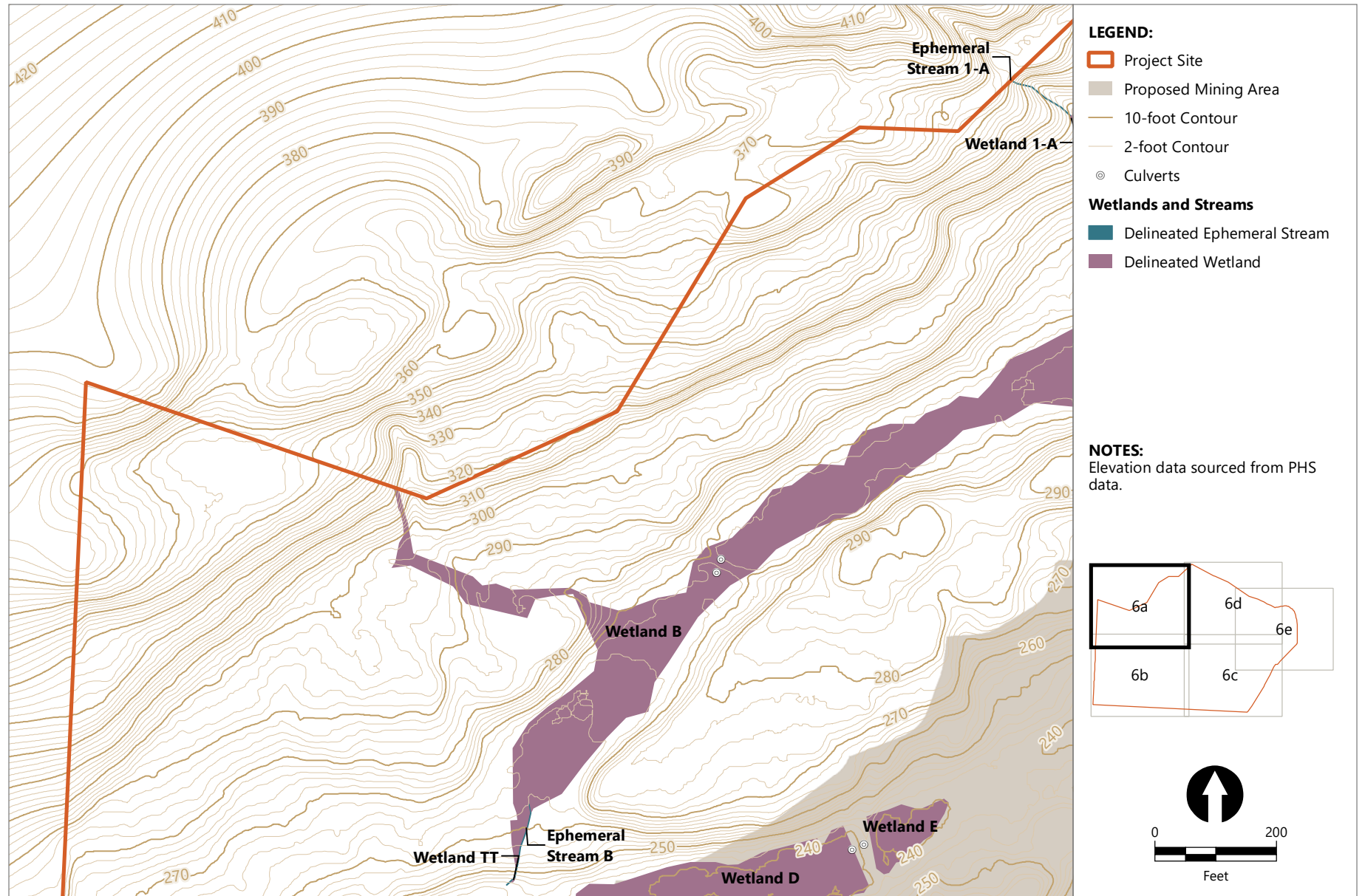


Publish Date: 2023/12/20, 1:26 PM | User: jfox
 Filepath: \\orcas\GIS\Jobs\Knife_River_Corp_2114\Watters_Quarry\Maps\JPA\AQ_JPA_Fig5_Existing_Conditions_Map.mxd



Figure 5
Existing Conditions Overview Map

Joint Permit Application
 Watters Quarry Phase II Project

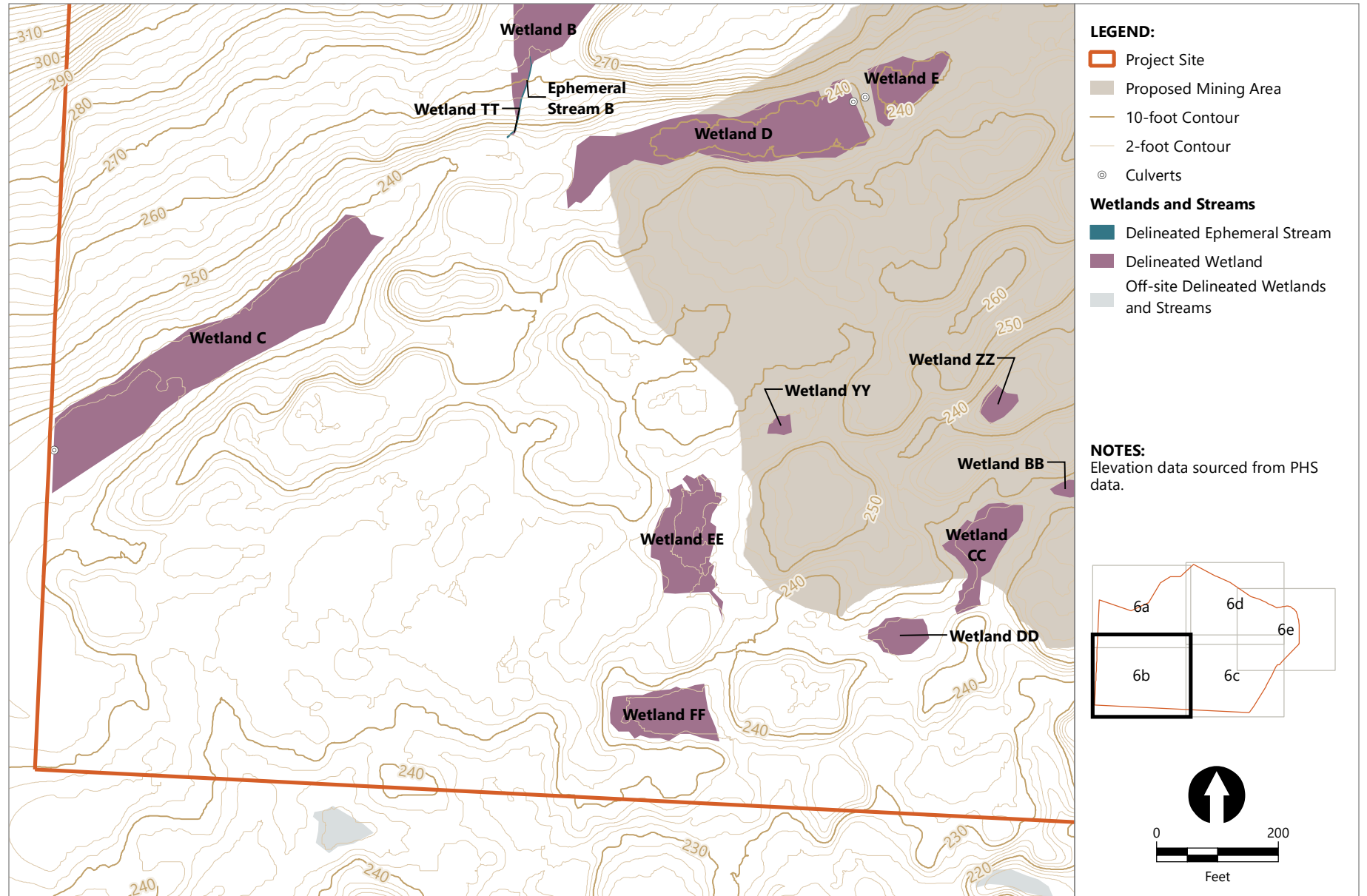


Publish Date: 2023/12/20, 3:20 PM | User: jfox
Filepath: \\orcas\GIS\Jobs\Knife_River_Corp_2114\Watters_Quarry\Maps\JPA\AQ_JPA_Fig6_Existing_Conditions_Details_Maps.mxd



Figure 6a
Existing Conditions Detail Map

Joint Permit Application
Watters Quarry Phase II Project

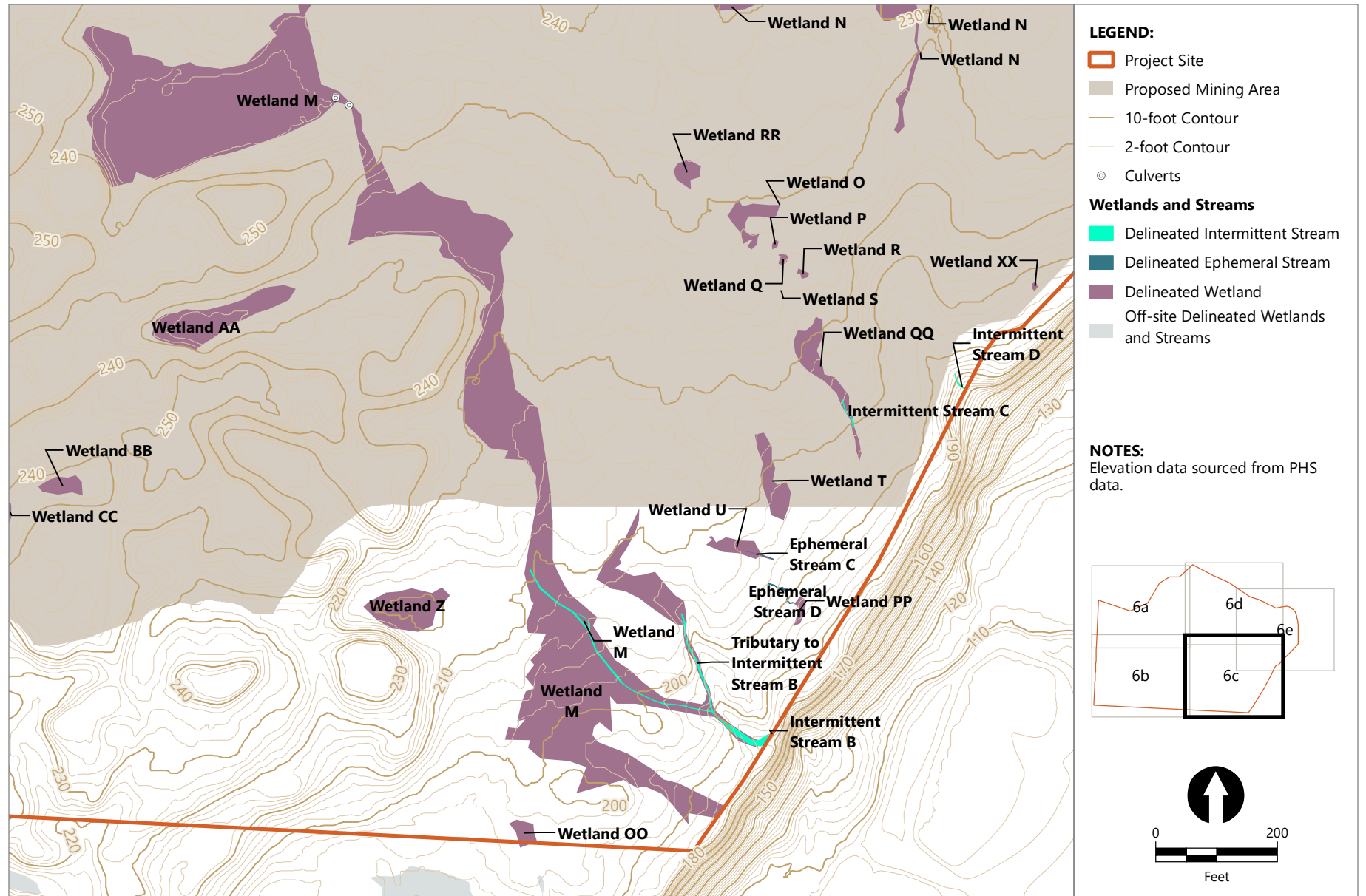


Publish Date: 2023/12/20, 3:20 PM | User: jfox
 Filepath: \\orcas\GIS\Jobs\Knife_River_Corp_2114\Watters_Quarry\Maps\JPA\AQ_JPA_Fig6_Existing_Conditions_Details_Maps.mxd



Figure 6b
Existing Conditions Detail Map

Joint Permit Application
 Watters Quarry Phase II Project

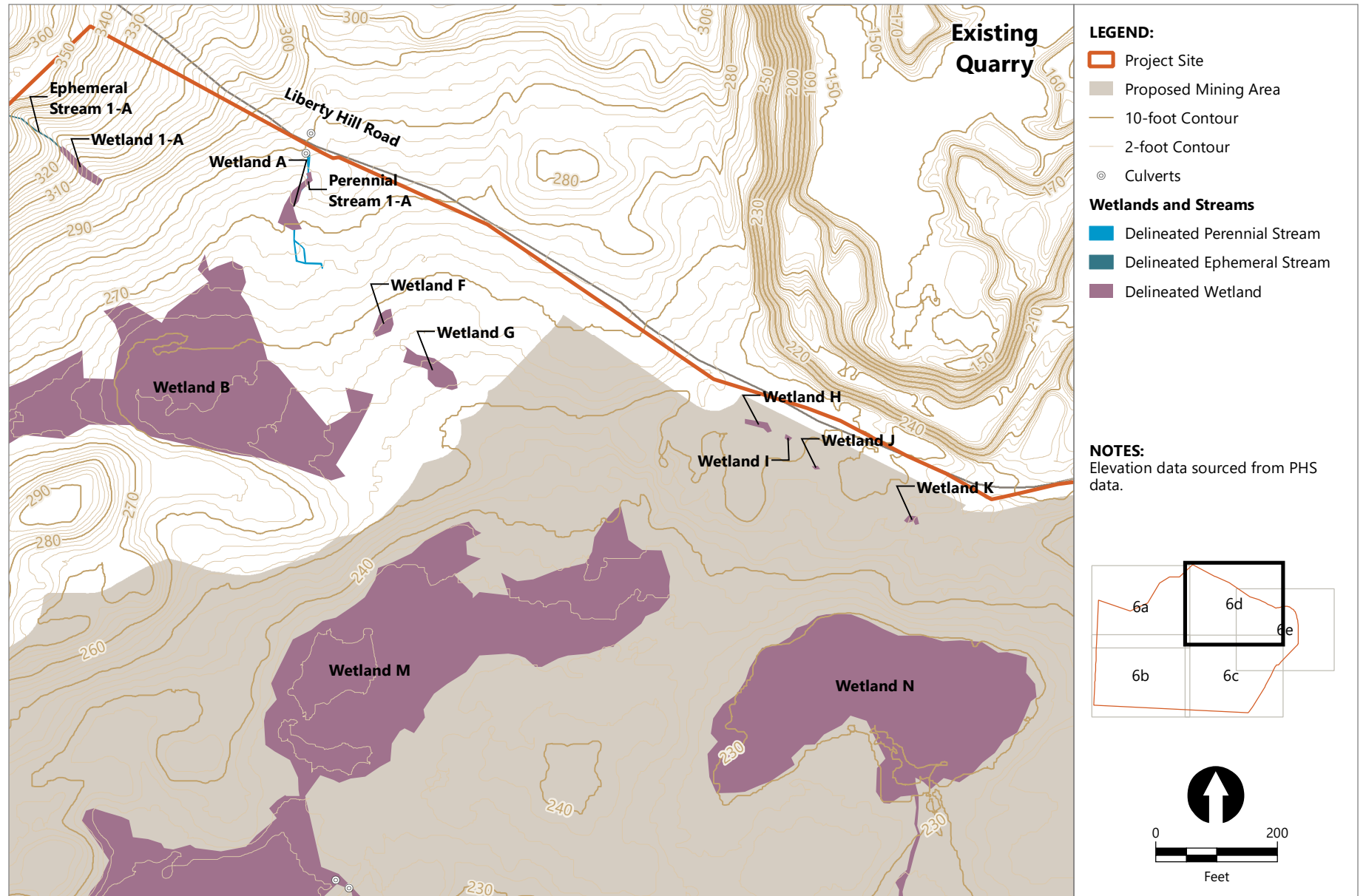


Publish Date: 2023/12/20, 3:20 PM | User: jfox
 Filepath: \\orcas\GIS\Jobs\Knife_River_Corp_2114\Watters_Quarry\Maps\JPA\AQ_JPA_Fig6_Existing_Conditions_Details_Maps.mxd



Figure 6c
Existing Conditions Detail Map

Joint Permit Application
 Watters Quarry Phase II Project

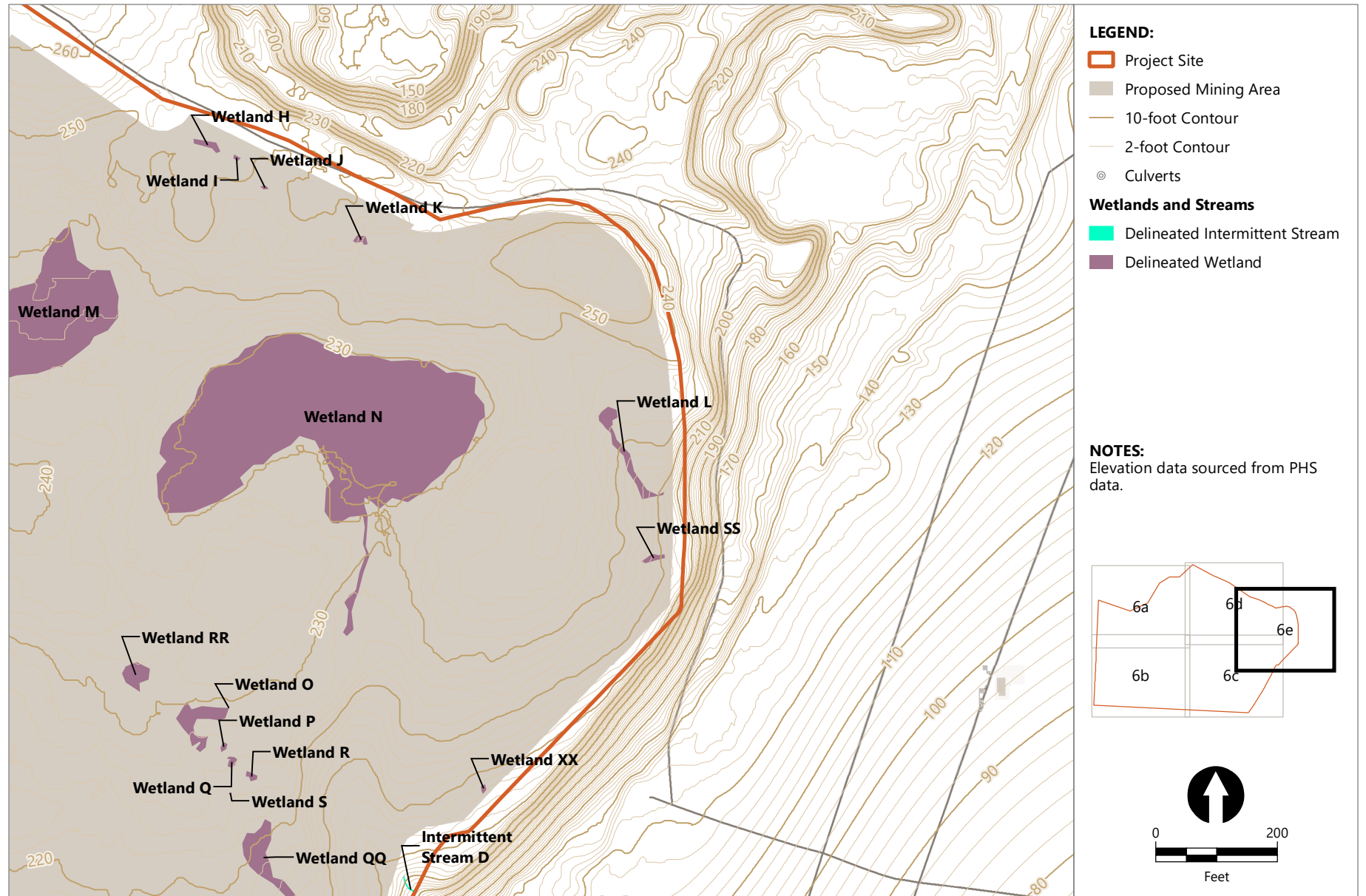


Publish Date: 2023/12/20, 3:20 PM | User: jfox
 Filepath: \\orcas\GIS\Jobs\Knife_River_Corp_2114\Watters_Quarry\Maps\JPA\AQ_JPA_Fig6_Existing_Conditions_Details_Maps.mxd



Figure 6d
Existing Conditions Detail Map

Joint Permit Application
 Watters Quarry Phase II Project

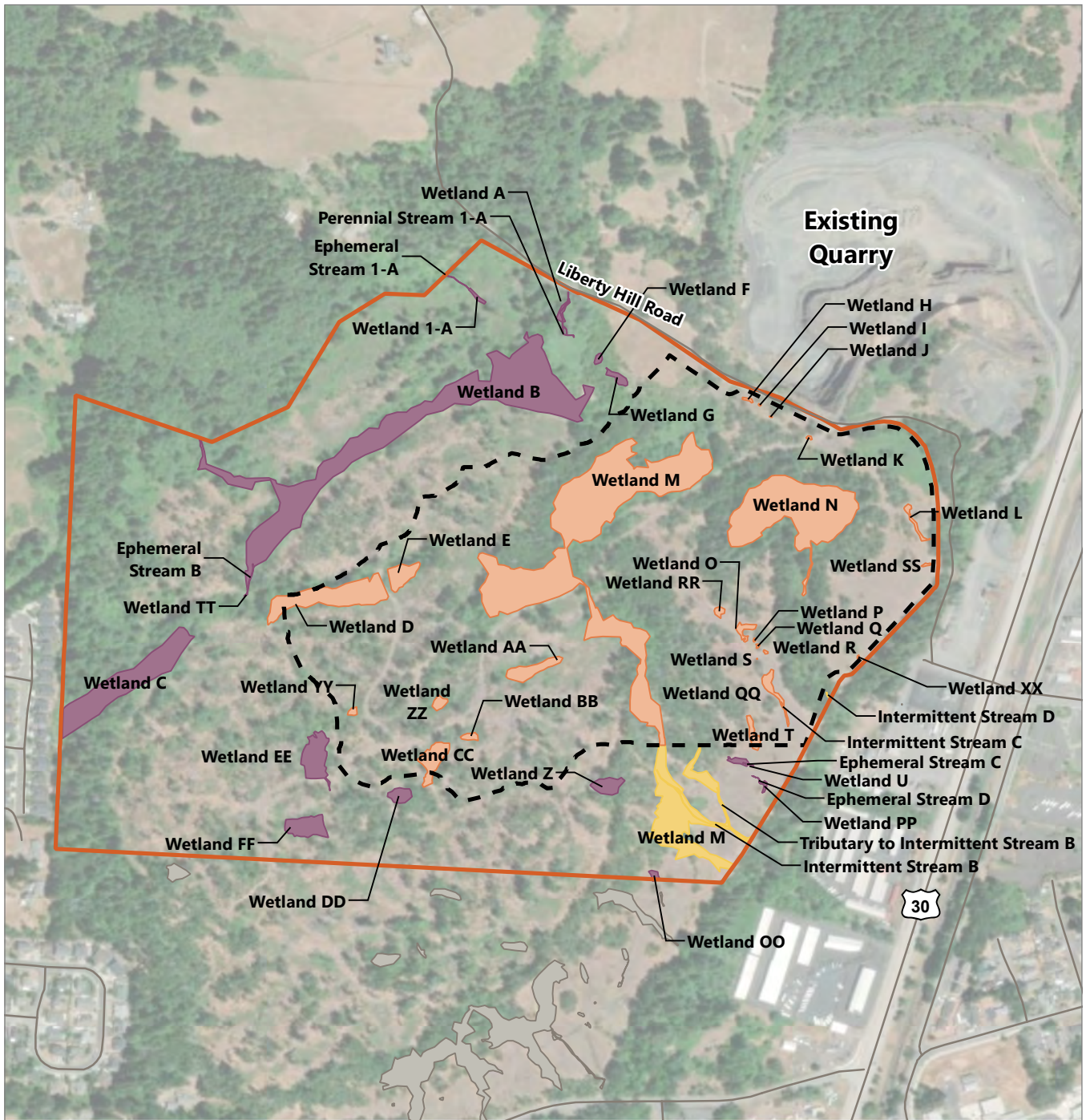


Publish Date: 2023/12/20, 3:20 PM | User: jfox
Filepath: \\orcas\GIS\Jobs\Knife_River_Corp_2114\Watters_Quarry\Maps\JPA\AQ_JPA_Fig6_Existing_Conditions_Details_Maps.mxd



Figure 6e
Existing Conditions Detail Map

Joint Permit Application
Watters Quarry Phase II Project



LEGEND:

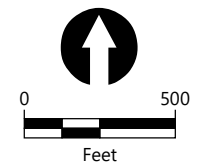
- Project Site
- Proposed Mining Area

Wetland and Stream Impacts

- Direct Impact
- Indirect Impact
- No Impact
- No Impact (Off Site)

NOTE:

1. Aerial imagery: Esri (2021)

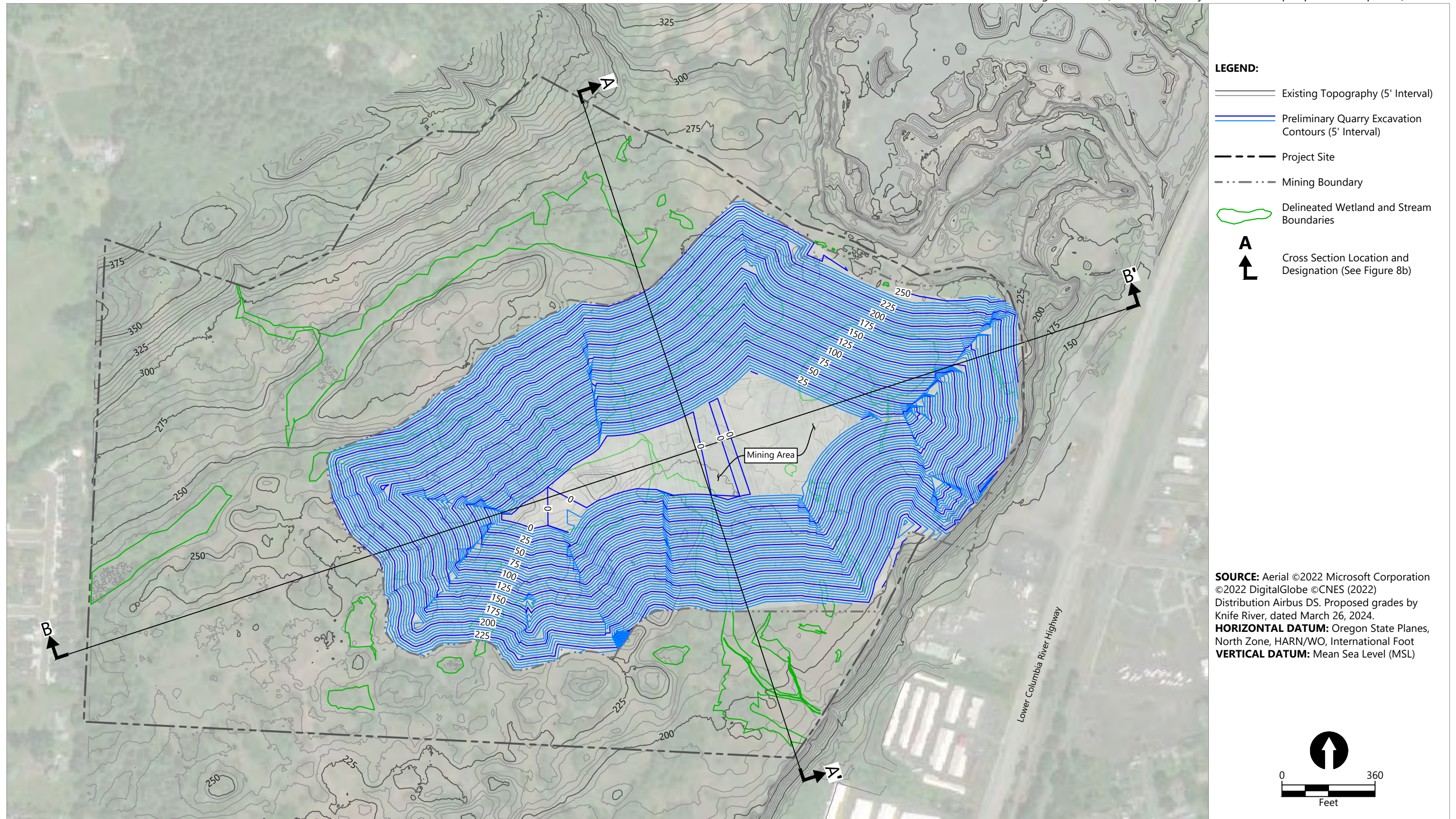


Publish Date: 2023/12/20, 1:30 PM | User: jfox
 Filepath: \\orcas\GIS\Jobs\Knife_River_Corp_2114\Watters_Quarry\Maps\JPA\AQ_JPA_Fig7_Proposed_Project_Overview_Map.mxd



Figure 7
Proposed Project Overview Map

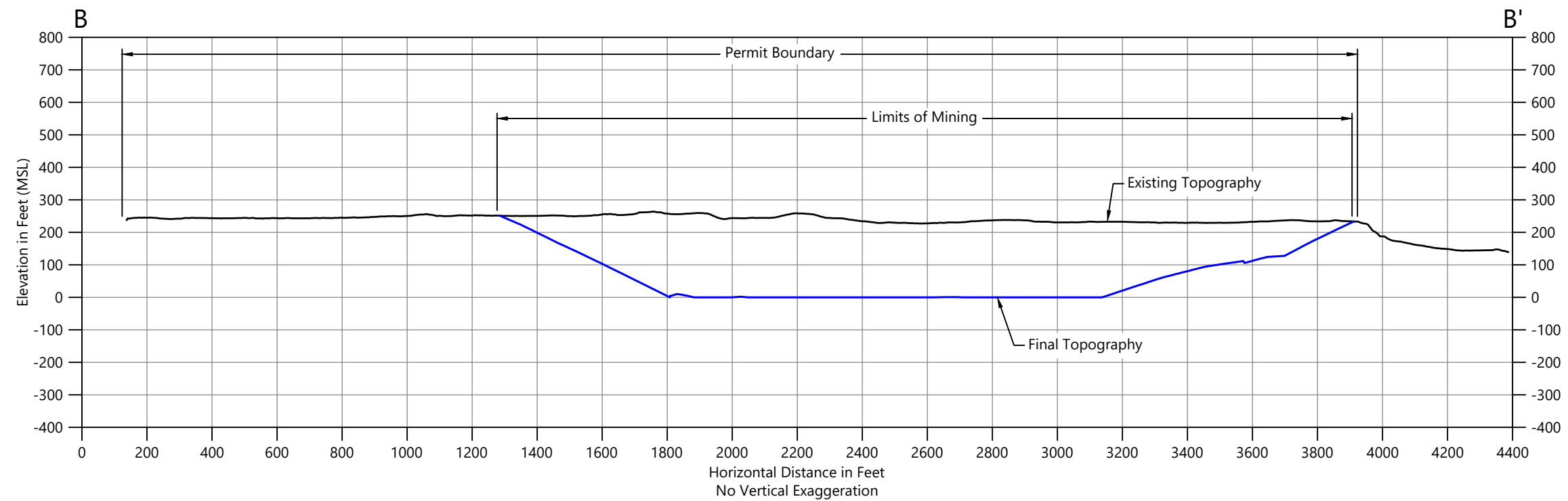
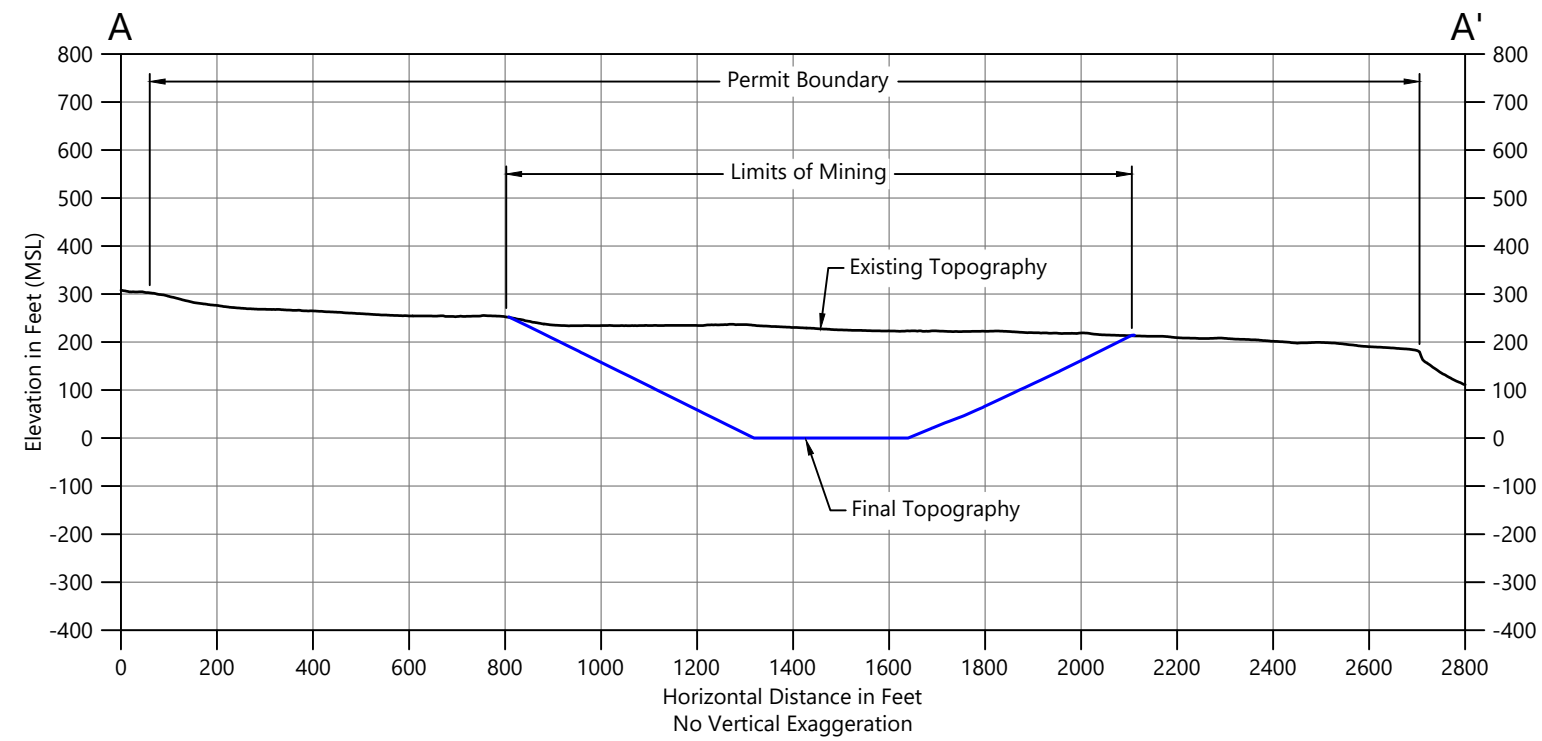
Joint Permit Application
 Watters Quarry Phase II Project



Publish Date: 2024/03/26 11:21 AM | User: chewett
Filepath: K:\Projects\2114-Knife River Corporation-NW\Watters Quarry Expansion\2114-RP-006 (Preliminary Mining Plan).dwg Figure 8a



Figure 8a
Phase II Mining Plan
Joint Permit Application
Watters Quarry Phase II Project

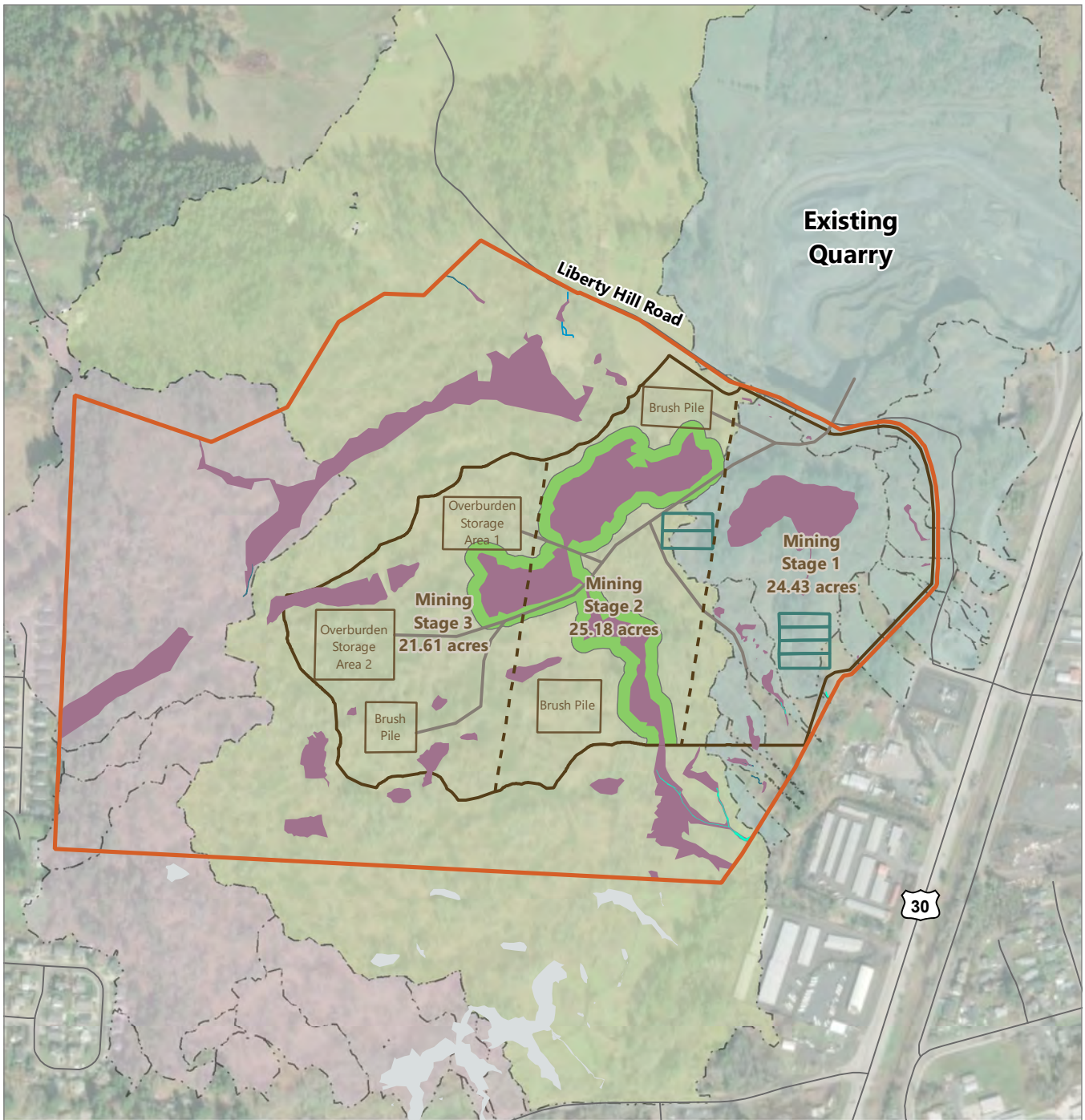


Publish Date: 2024/03/26 11:21 AM | User: chewett
Filepath: K:\Projects\2114-Knife River Corporation-NW\Watters Quarry Expansion\2114-RP-006 (Preliminary Mining Plan).dwg Figure 8b



Figure 8b
Phase II Mining Cross Sections A-A' and B-B'

Joint Permit Application
Watters Quarry Phase II Project

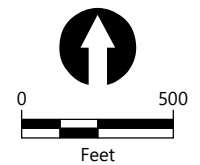


LEGEND:

- | | |
|----------------------|--|
| Project Site | Wetlands and Streams |
| Proposed Mining Area | Delineated Perennial Stream |
| Stormwater Pond | Delineated Intermittent Stream |
| Haul Road | Delineated Ephemeral Stream |
| 50-foot Setback | Delineated Wetland |
| | Off-site Delineated Wetlands and Streams |

NOTE:

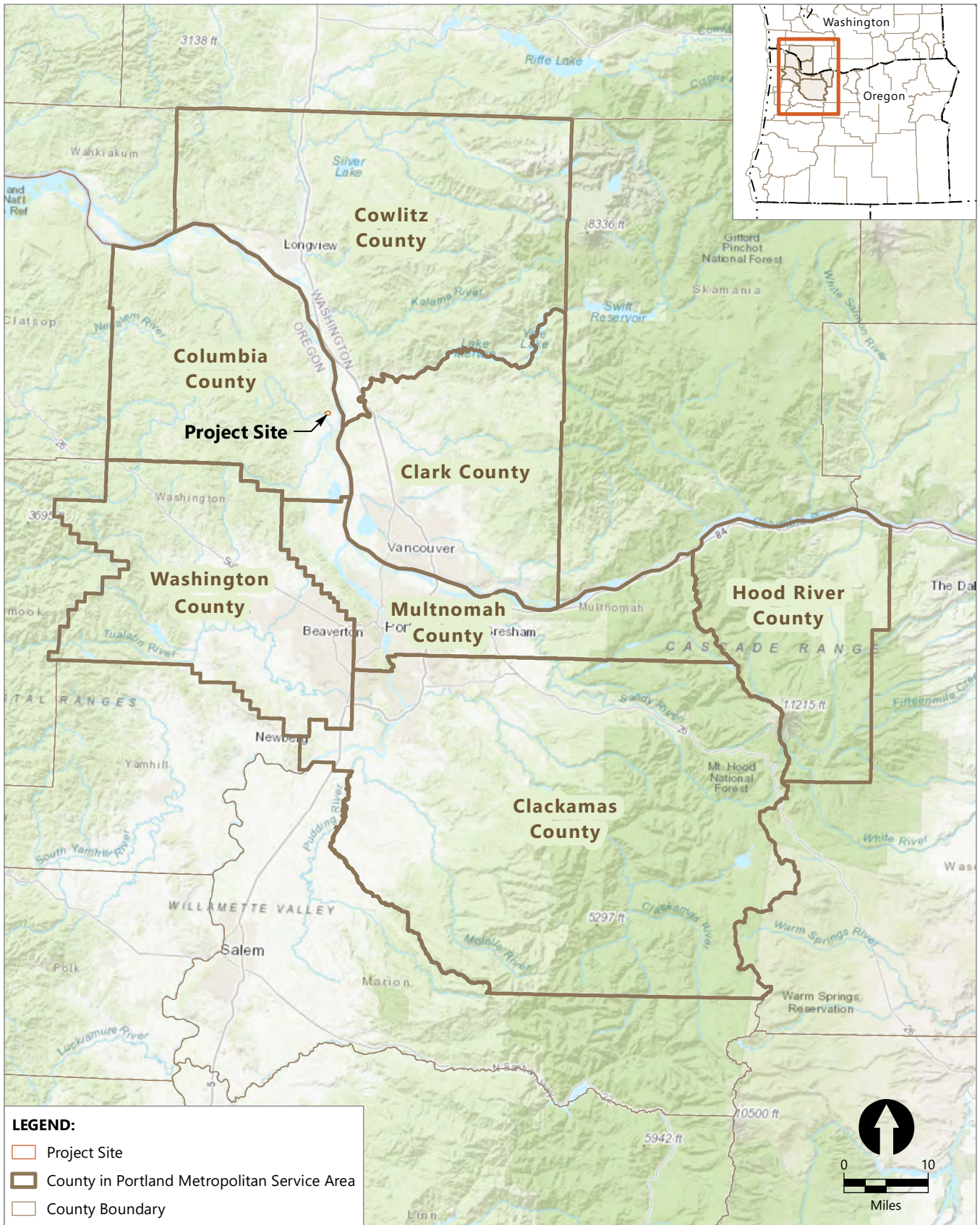
1. Aerial imagery: Esri (2021)



Publish Date: 2024/03/29, 4:43 PM | User: jfox
 Filepath: \\orcas\GIS\Jobs\Knife_River_Corp_2114\Watters_Quarry\Maps\JPA\AQ_JPA_Fig9_Project_Stages_Map.mxd



Figure 9
Project Stages Map
 Joint Permit Application
 Watters Quarry Phase II Project

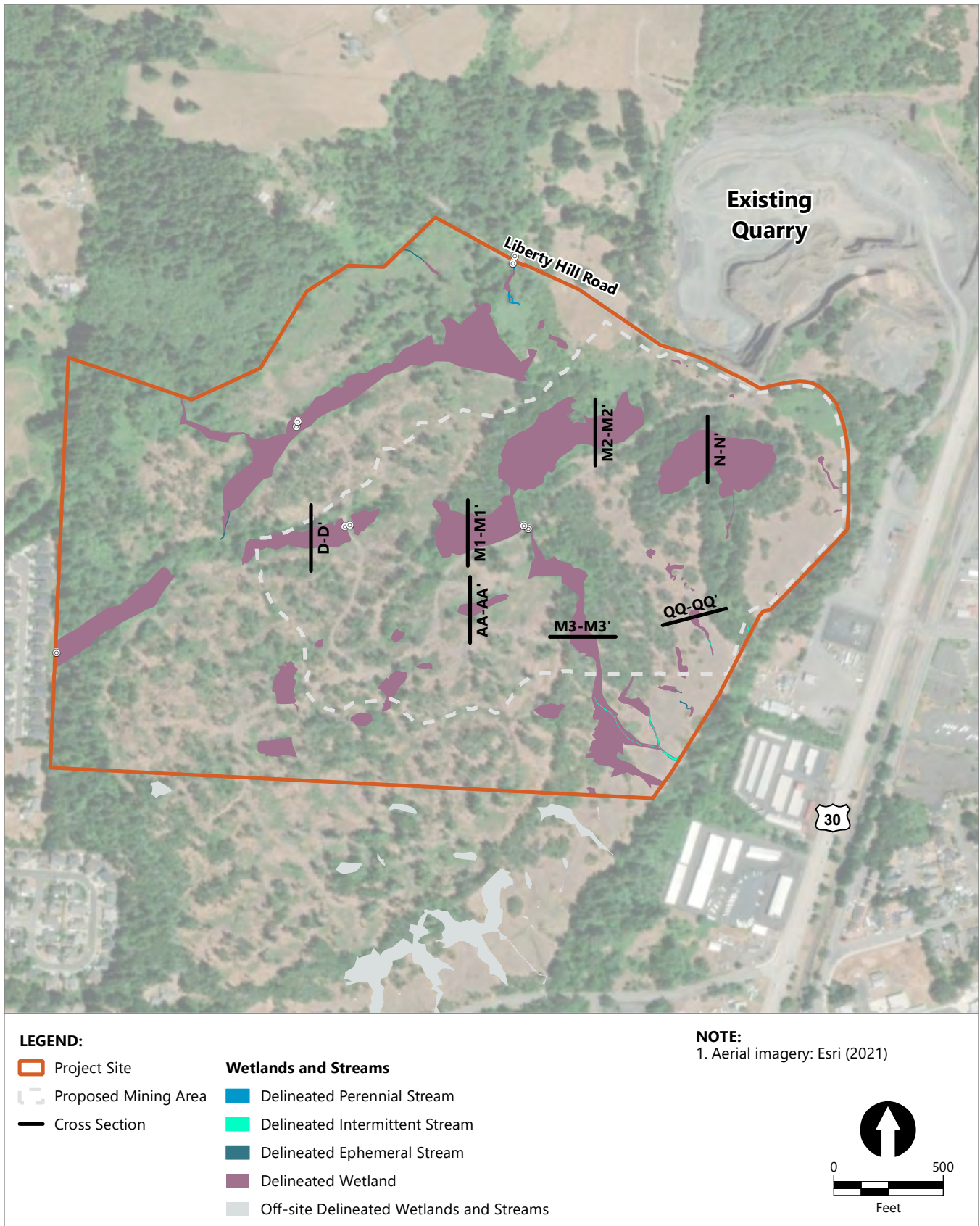


Publish Date: 2024/03/29, 4:49 PM | User: jfox
Filepath: \\orcas\GIS\Jobs\Knife_River_Corp_2114\Watters_Quarry\Maps\JPA\AQ_JPA_Fig10_Portland_Metro_Service_Area.mxd



Figure 10
Portland Metropolitan Service Area Map

Joint Permit Application
Watters Quarry Phase II Project

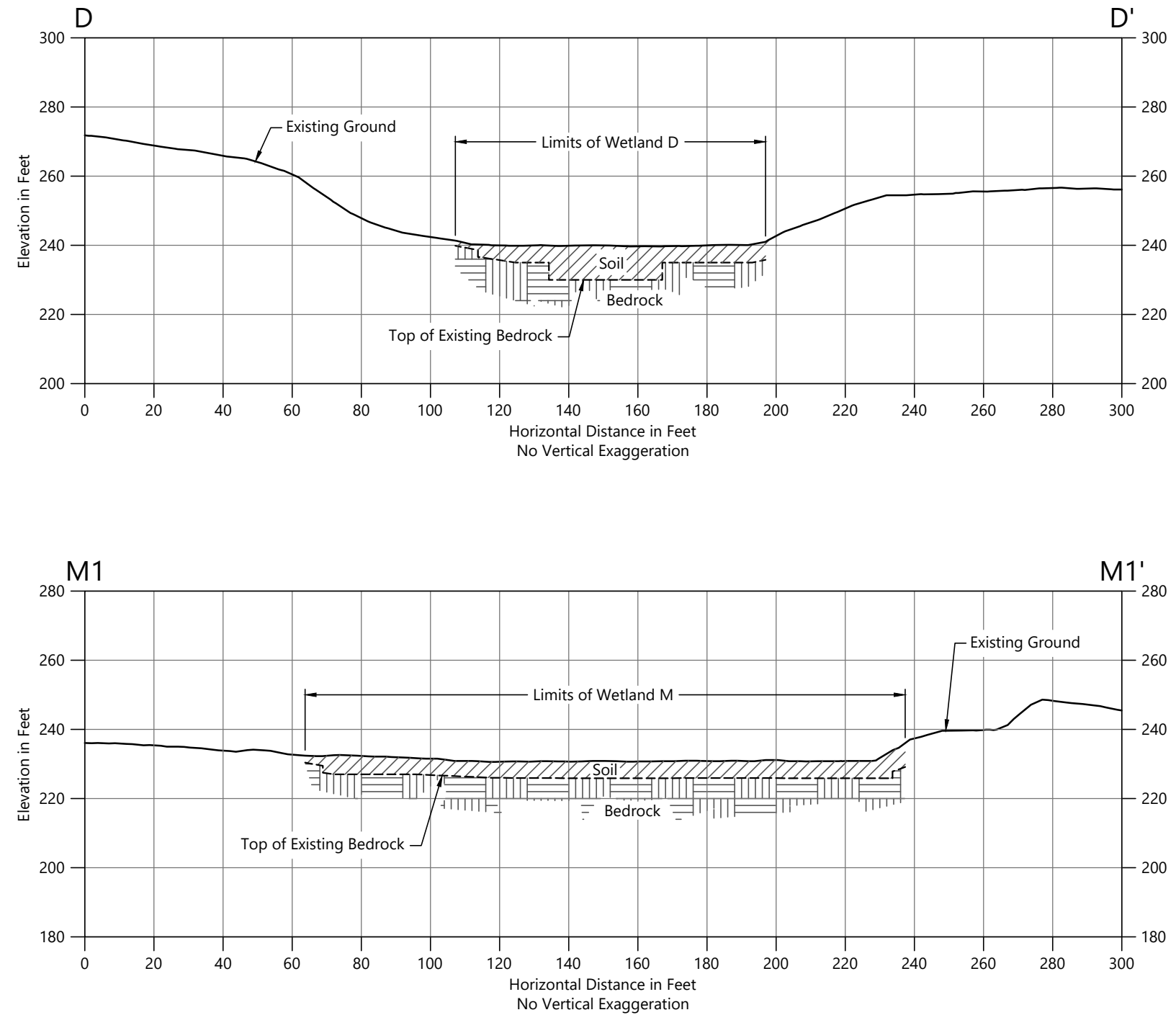


Publish Date: 2023/12/20, 1:34 PM | User: jfox
Filepath: \\orcas\GIS\Jobs\Knife_River_Corp_2114\Watters_Quarry\Maps\JPA\AQ_JPA_Fig11_Wetl_Watr_Impact_XS_Locations.mxd



Figure 11
Wetland and Water Impact Cross-Section Locations

Joint Permit Application
Watters Quarry Phase II Project

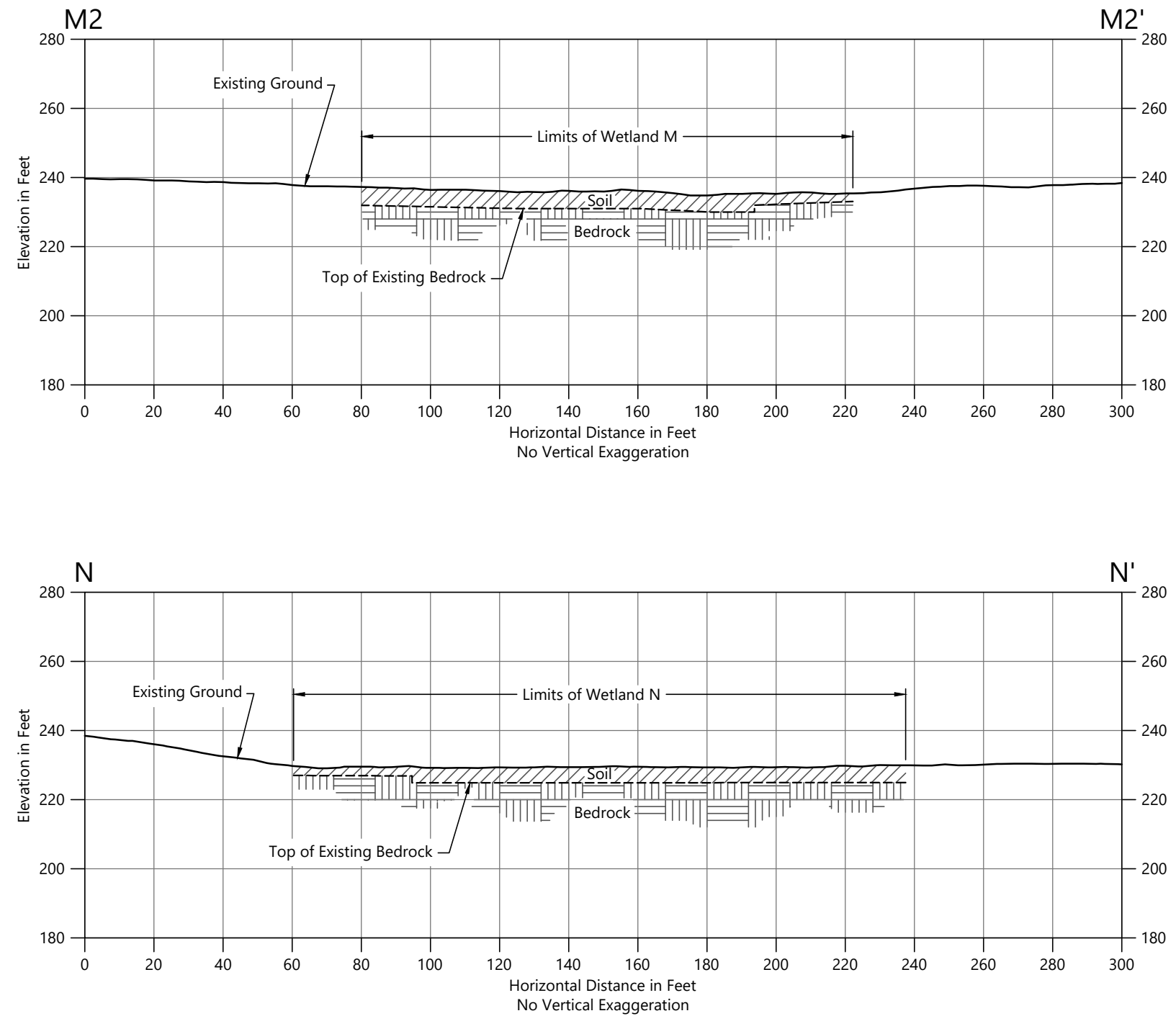


Publish Date: 2023/09/11 4:58 PM | User: dholmer
Filepath: K:\Projects\2114-Knife River Corporation-NW\Watters Quarry Expansion\2114-RP-001 (Cross Sections).dwg Figure 10a



Figure 12a
Wetland D and Wetland M1 Cross Sections

Joint Permit Application
Watters Quarry Expansion Project

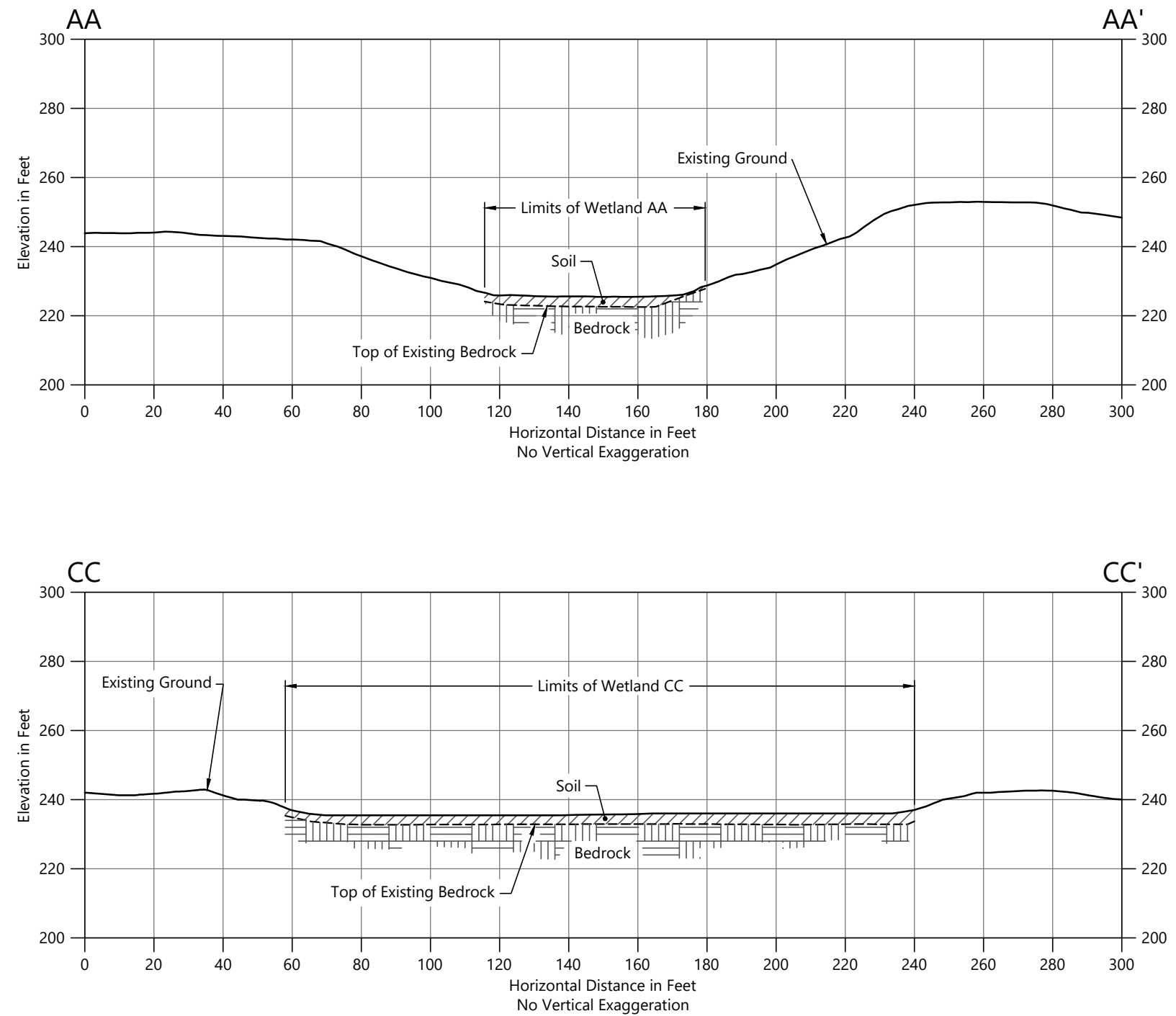


Publish Date: 2023/09/11 4:58 PM | User: dholmer
Filepath: K:\Projects\2114-Knife River Corporation-NW\Watters Quarry Expansion\2114-RP-001 (Cross Sections).dwg Figure 10b



Figure 12b
Wetland M2 and Wetland N Cross Sections

Joint Permit Application
Watters Quarry Expansion Project

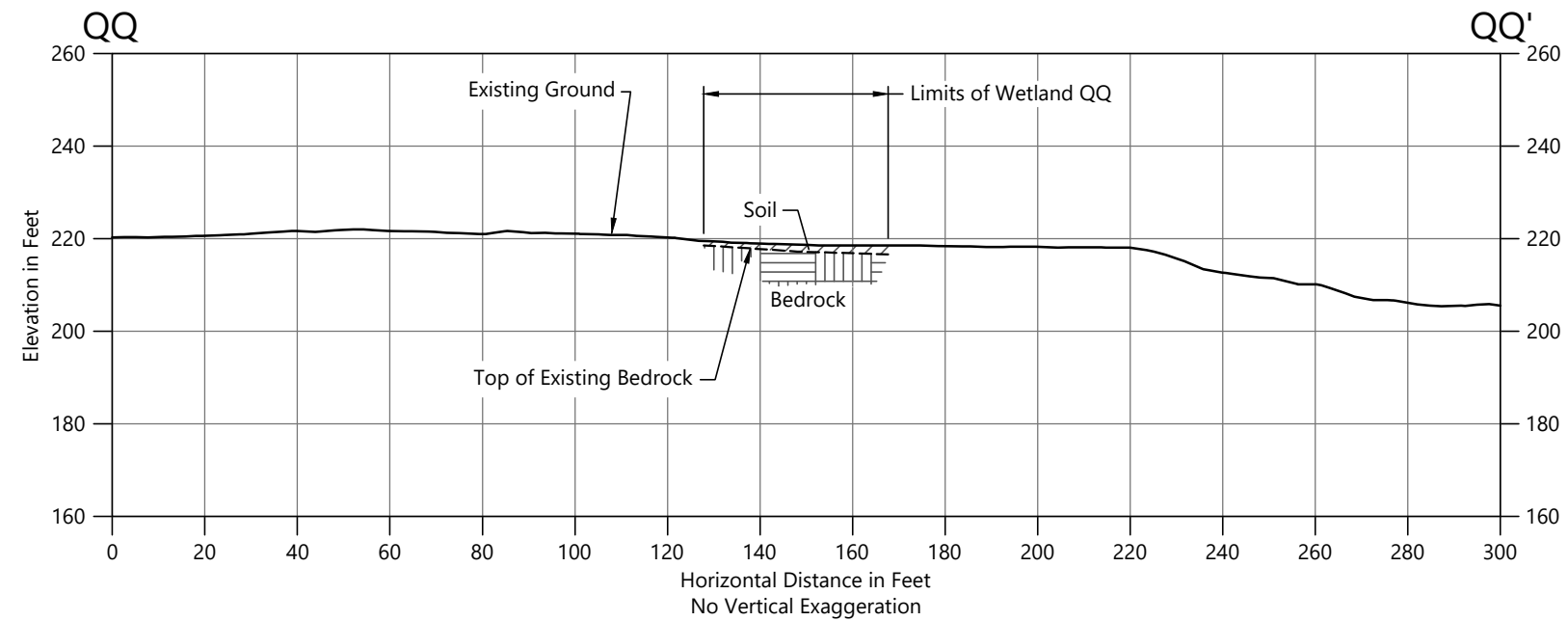
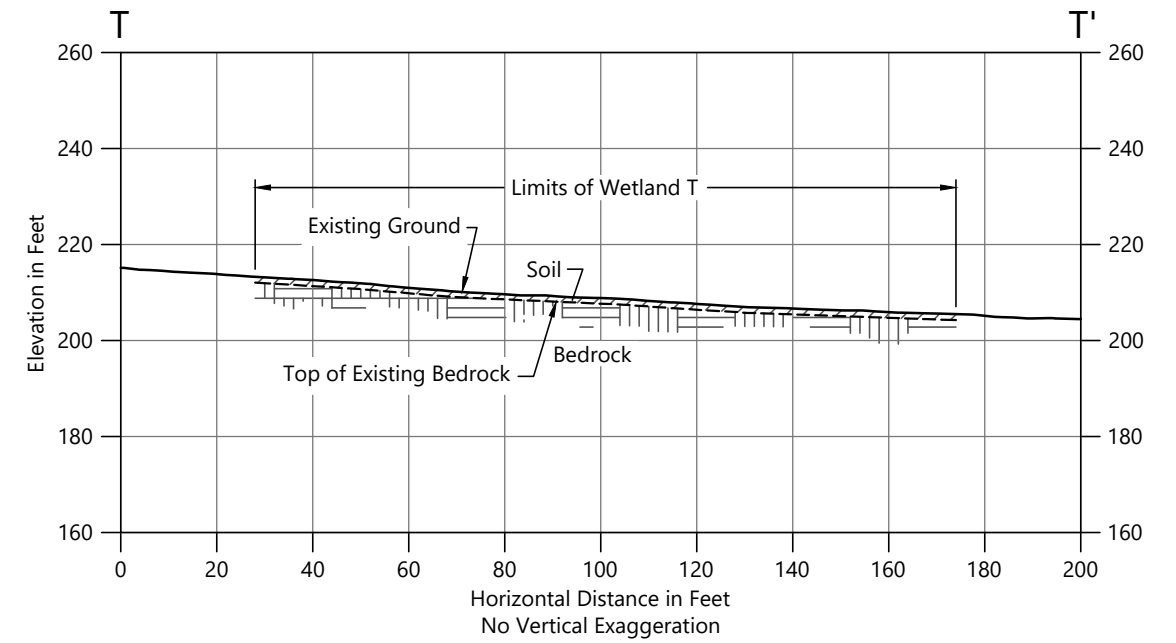
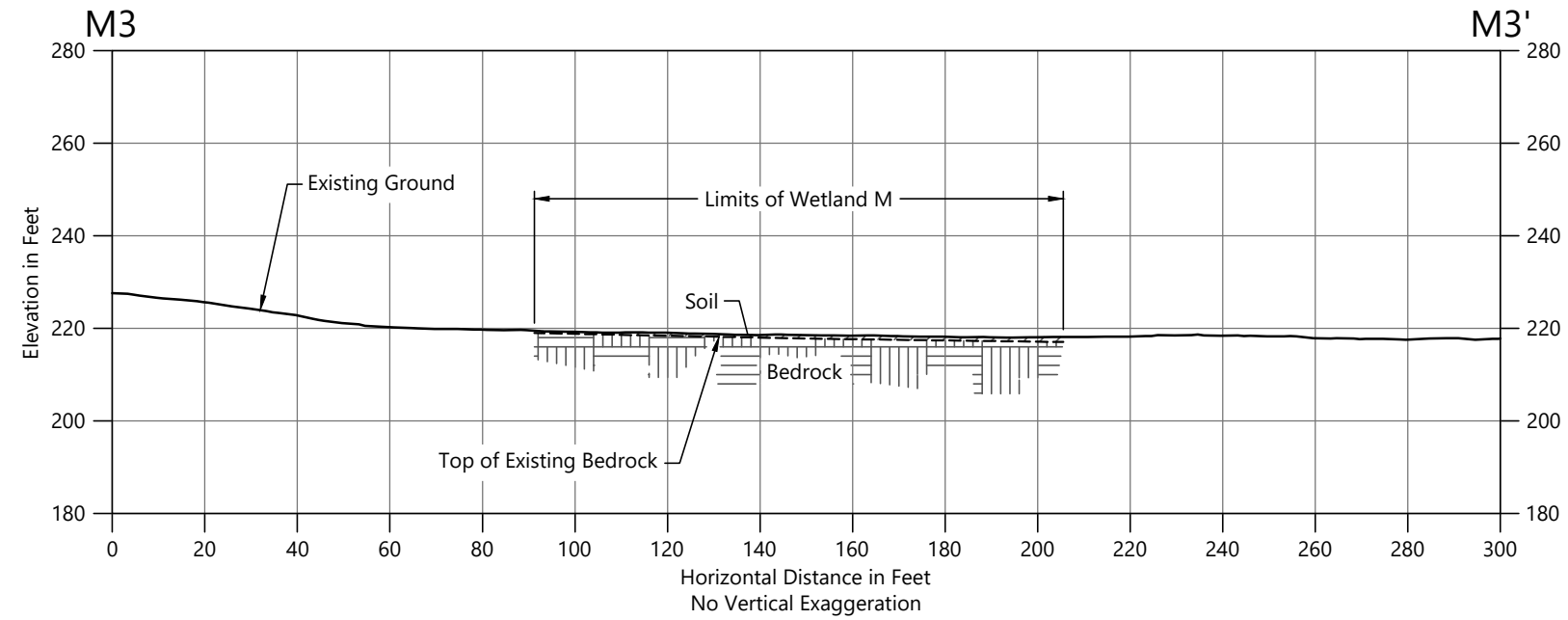


Publish Date: 2023/09/11 4:58 PM | User: dholmer
Filepath: K:\Projects\2114-Knife River Corporation-NW\Watters Quarry Expansion\2114-RP-001 (Cross Sections).dwg Figure 10c



Figure 12c
Wetland AA and Wetland CC Cross Sections

Joint Permit Application
Watters Quarry Expansion Project

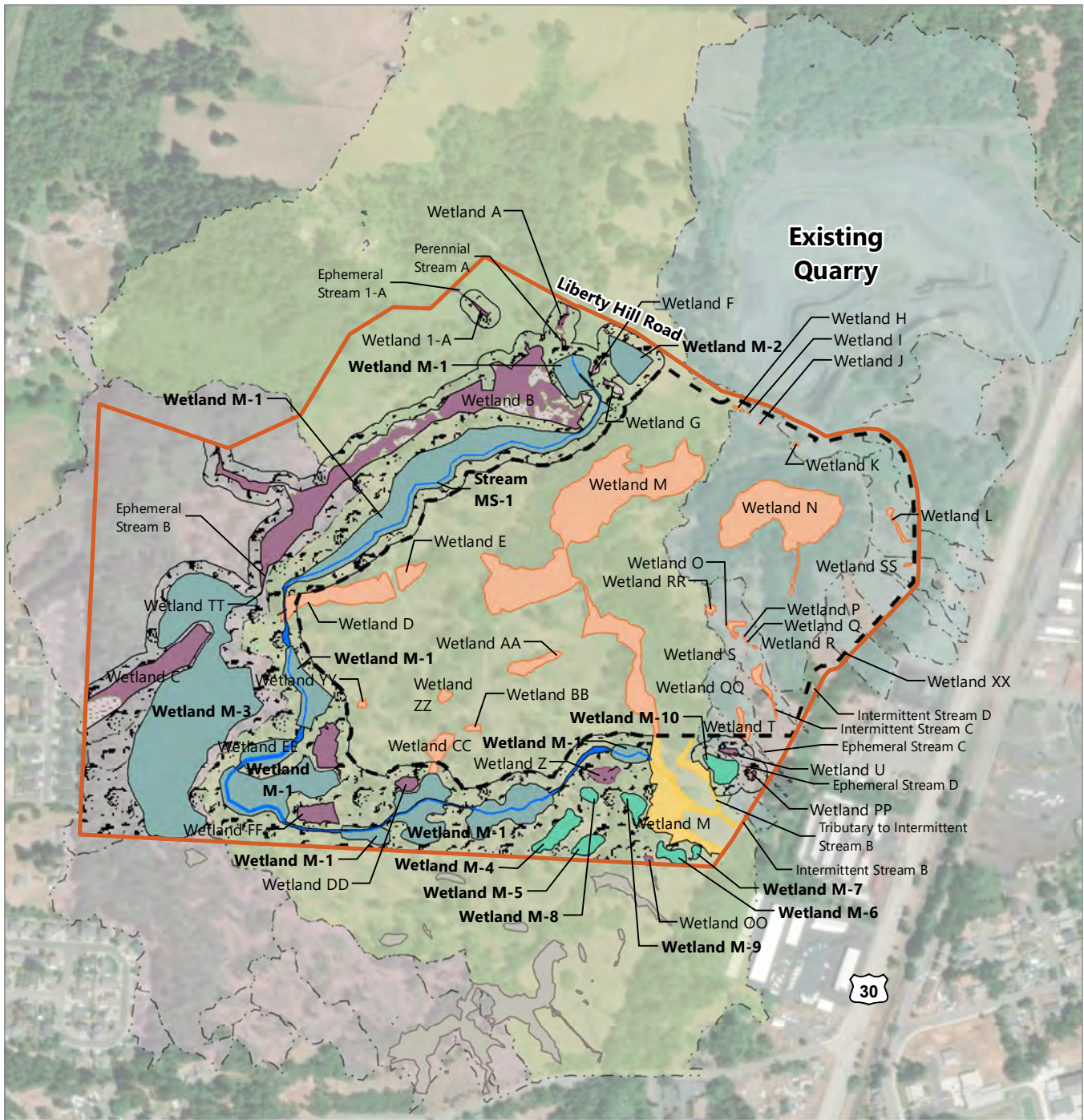


Publish Date: 2023/09/11 4:58 PM | User: dholmer
 Filepath: K:\Projects\2114-Knife River Corporation-NW\Watters Quarry Expansion\2114-RP-001 (Cross Sections).dwg Figure10d



Figure 12d
Wetland M, Wetland QQ, and Wetland T Cross Sections

Joint Permit Application
 Watters Quarry Expansion Project

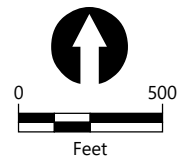


LEGEND:

- | | | |
|-----------------------|-----------------------------------|-------------------------------------|
| Project Site | Wetland and Stream Impacts | Compensatory Mitigation Plan |
| Proposed Mining Area | Direct Impact | Perennial Stream |
| Drainage Basin | Potential Indirect Impact | ARSC Wetland |
| Eastern Basin | No Impact | Wetland |
| Central Basin | No Impact (Off Site) | Wetland Enhancement Area |
| Western Basin | Wetland and Stream Buffer | |

NOTE:

1. Aerial imagery: Esri (2021)



Publish Date: 2023/12/20, 1:36 PM | User: jfox
 Filepath: \\corcas\GIS\Jobs\Knife_River_Corp_2114\Watters_Quarry\Maps\JPA\AQ_JPA_Fig13_Compensatory_Mitigation_Overview_Map.mxd



Figure 13
Compensatory Mitigation Overview Map

Joint Permit Application
 Watters Quarry Phase II Project

Attachment A
Incumbency Certificate

INCUMBENCY CERTIFICATE

Knife River Corporation - Northwest (entity name as recorded with the Secretary of State, Oregon)

I, **Jeff Steyaert** (name of registered agent or authorized representative), do hereby certify that:

1. I am the duly elected and acting **Environmental, Permitting, and Property Manager** (position) of **Knife River Corporation - Northwest** (entity name as recorded with the Secretary of State, Oregon), a **Corporation** (entity type) organized and existing in good standing under the laws of the State of Oregon (the "Entity"); and
2. I have the authority to submit, on behalf of the Entity, this application for a permit to conduct removal-fill within waters of the state (as evidenced by my signature on the application) and to commit the Entity to comply with all resulting permit conditions, including any mitigation obligations, resulting from the issuance of the permit.



Jeffrey R. Steyaert
Assistant Secretary

Signature of Registered Agent or Authorized Representative, this 29th day of MARCH, 2024

CERTIFICATE

I, Dani M. Krause, hereby certify that I am the duly elected and qualified Assistant Secretary of Knife River Corporation – Northwest, an Oregon corporation; and I further certify that, pursuant to a resolution adopted by Written Consent of the Board of Directors dated September 26, 2023, the persons named below have been duly elected, have qualified and are officers of the Company holding the offices set forth opposite their respective names:

Amanda M. Bewley	Vice President of Operations – West Division
Brandon D. Bond	Vice President of Operations – North Division
Nancy K. Christenson	Treasurer and Chief Financial Officer
Chris C. Doan	Vice President of Operations – South Central Division
Stratos J. Flanders	Region President
Peter J. Gay	Vice President – Prestress
Brian R. Gray	Chair of the Board and Chief Executive Officer
Ethan Hasenstein	Assistant Secretary
Molly Hesseltine	Assistant Secretary
Dani M. Krause	Assistant Secretary
Karl A. Liepitz	Chief Legal Officer and Secretary
Steven D. Mote	Region Vice President
Darek L. Nieuwsma	Region Controller and Assistant Secretary
Jeffrey R. Steyaert	Assistant Secretary

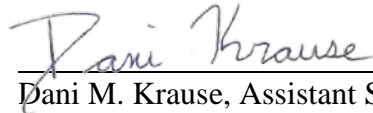
* * * * *

I further certify that the following is a true and correct copy of Section 5.13 of the Bylaws of Knife River Corporation – Northwest, which sets forth the powers of the officers to execute documents; and that said Bylaw Section is presently in full force and effect:

5.13 Execution of Instruments. All deeds, bonds, mortgages, notes, contracts and other instruments shall be executed on behalf of the Corporation by the Chairman of the Board, the Chief Executive Officer, the President, any Vice President or Assistant Vice President, the General Counsel, any other officer who performs a policy-making function (such as administration, operations, accounting, or finance) or such other officer or agent of the Corporation as shall be duly authorized by the Board of Directors. Any officer or agent executing any such documents on behalf of the Corporation may do so (except as otherwise required by applicable law) either under or without the seal of the Corporation and either individually or with an attestation, according to the requirements of the form of the

instrument. If an attestation is required, the document shall be attested by the Secretary or an Assistant Secretary or by the Treasurer or an Assistant Treasurer or any other officer or agent authorized by the Board of Directors. When authorized by the Board of Directors, the signature of any officer or agent of the Corporation may be a facsimile.

IN WITNESS WHEREOF, I have hereunto set my hand on October 3, 2023.

A handwritten signature in cursive script that reads "Dani Krause". The signature is written in black ink and is positioned above a horizontal line.

Dani M. Krause, Assistant Secretary

Knife River Corporation – Northwest
32260 Old Hwy 34
Tangent, OR 97389-9770
Ph: (541) 918-5100

Corporate Office: Fax (541) 918-5375
AR Dept.: Fax (541) 918-5376
HR/Payroll Dept.: Fax (541) 918-5378
Willamette Valley: Fax (541) 928-6490

June 13, 2022

Weyerhaeuser NR Company
Attn: Mary Castle
33671 S. Dickey Prairie Rd.
Molalla, OR-97038

**By Certified Mail and Email to
mary.castle@weyerhaeuser.com**

Re: Watters Quarry Aggregate and Rock Products Lease Renewal

Dear Mary:

Knife River Corporation – Northwest hereby notifies Weyerhaeuser NR Company of Knife River's intent to renew the Aggregate and Rock Products Lease Agreement dated August 31, 1992 for the Watters Quarry. This renewal shall be for a period of 5 years under subsection 2.2 of the lease agreement and under the same terms and conditions. This renewal shall run through August 31, 2027.

Best regards,



Ethan Hasenstein
Contracts, Risk & Legislative Affairs Manager

Attachment B

Columbia County Conditional Use Permit

BEFORE THE COUNTY PLANNING COMMISSION
FOR COLUMBIA COUNTY, STATE OF OREGON

In the Matter of the Application for)
J H & D, Inc. (Watters Concrete) For)
a Conditional Use Permit in the) Final Order CU 22-92
Primary Forest-76 Zone)

This matter came before the Columbia County Planning Commission on the application of J H & D, Inc. for a Conditional Use Permit to expand an existing surface mining operation into a new area of about 130 acres in the Primary Forest-76 zone.

The subject property is described on the Assessor's records as 5132-000-01600 and 5133-000-00400.

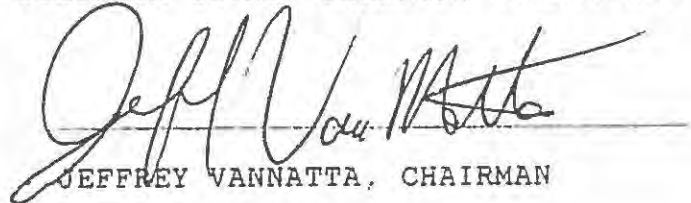
The hearing was held on August 3, 1992. Testimony was submitted on behalf of the applicant. The Planning Commission having heard the arguments of the parties and having considered its testimony and the report of the Planning Commission Staff Report.

The Planning Commission orders this application for a Conditional Use Permit in the Primary Forest-76 zone to expand an existing surface mining operation into a new area of about 130 acres in the PF-76 zone is approved adopting staff findings, conditions and conclusions as stated in the attached report, deleting condition #1. The Commission stated that ODOT would determine the exact location for access on and off Highway 30 and the operator shall fence each area (cyclone fence) of excavation & post it with warning signs and shall follow operating standards in Section 1044-1066 of

DATE 8/3/92

Zoning Ordinance.

COLUMBIA COUNTY PLANNING COMMISSION


JEFFREY VANNATTA, CHAIRMAN

Columbia County Planning Commission
STAFF REPORT - PF-76 ZONE
Conditional Use Permit

FILE NUMBER: CU 22-92

APPLICANT: J.H. & D., Inc.
Watters Concrete, Inc.
P.O. Box 405,
St. Helens, OR 97051

PROPERTY LOCATION: 60371 Columbia River Hwy., St. Helens,
OR, and 185 acres north of Pittsburg
Road and west of Highway 30 and the
strip development along the highway.

REQUEST: To expand an existing surface mining
operation into a new area of about 130
acres in a PF-76 zone, for which a
conditional use permit is required.

TAX ACCT. NUMBERS: 5132-000-01600 and 5133-000-00400

ZONING: Primary Forest (PF-76)

BACKGROUND:

The applicants request approval to expand a basalt rock mining operation into a new area of about 130 acres, part of 2 tax lots totalling 185.41 acres. The unmined area of the property will be the southernmost 55 acres within the St. Helens Urban Growth Boundary. Applicants expect to mine about 120 acres because of property line setbacks.

There are no existing structures on the property, which has access to Pittsburg Road, although that access will not be used; all rock will be trucked out through the present pit. Water and sewage treatment will not be needed. The property is within the St. Helens Rural Fire Protection District.

Soils on the property are as follows:

	Est. % of Area	Agric. Capab. Class	D.F. Site Index
Rock Outcrop-Xerumbrepts complex	85	VIIIe	-
Bacona silt loam, 3-30% slopes	5	VIe	162
Cascade silt loam, 8-15% slopes	3	IIIe	153
Cornelius silt loam, 8-15% slopes	2	IIIe	165
Cornelius silt loam, 15-30% slopes	5	IVe	165

Almost all of the area proposed to be mined is basalt rock outcrop, mixed with areas of shallow, well drained loam 10 to 20 inches deep. These lands are poorly suited to any farm or forest uses, commercial or residential uses, or even recreational development. The main limitations are the variable slopes, shallow soils, rock at the surface, rapid

runoff and drainage, droughtiness, the inability of septic systems to function, and high excavation costs for foundations and water and sewer lines. All of the productive soils are in the northwest corner of the property, where the land slopes down to farm and forest lands.

FINDINGS:

The following sections of the Zoning Ordinance are pertinent to this application:

"Section 503 Conditional Uses: In the PF zone the following conditional uses and their accessory uses are permitted subject to the provisions of Sections 504 and 505. A conditional use shall be reviewed according to the procedures provided in Section 1503.

.2 Operations conducted for the exploration, mining and processing of geothermal, aggregate, and other mineral or subsurface resources not permitted outright."

Finding 1: In the PF-76 zone, a surface mining operation requires a conditional use permit.

"Section 504 All Conditional Uses Permitted In The PF Zone Shall Meet The Following Requirements:

.1 The use is consistent with forest and farm uses and with the intent and purposes set forth in the Oregon Forest Practices Act."

The Oregon Forest Practices Act (ORS Chapter 527) has the following:

"527.630 Policy. (1) ...it is declared to be the public policy of the State of Oregon to encourage economically efficient forest practices that assure the continuous growing and harvesting of forest tree species and the maintenance of forest land for such purposes as the leading use on privately owned land, consistent with sound management of soil, air, water and fish and wild-life resources that assures the continuous benefits of those resources for future generations of Oregonians."

Finding 2: The above policy would not seem to apply to this operation, as 85% of the property is rock outcrops with pockets of shallow soils with no Douglas-fir site index and no timber producing value. Predominant vegetation is white oak, poison oak, grasses and a few firs.

Continuing with Section 504 of the Zoning Ordinance:

- ".2 The use will not significantly increase the cost, nor interfere with accepted forest management practices or farm uses on adjacent or nearby lands devoted to forest or farm use."

Finding 3: Properties around the subject property range from 1.03 to 83.95 acres and are being used for industrial, mining, small homestead and farm uses. The city limits of St. Helens are immediately south of the subject property, although the mining operation will stay north of the Urban Growth Boundary, which will keep it a minimum of about 1000' north of Pittsburg Road. The only farm operation in the area appears to be a 21.25 acre parcel to the west, which is inside the city limits of St. Helens. There should be no interference with any residential or farming operation adjacent to the mining operation, if the setbacks required by Section 1044.4 of the Zoning Ordinance are observed (i.e. 50' from all property lines and 200' from all residences or residentially zoned properties, without written consent of the property owner).

Continuing with Section 504 of the Zoning Ordinance:

- ".3 The use will be limited to a site no larger than necessary to accommodate the activity and, as such will not materially alter the stability of the overall land use pattern of the area or substantially limit or impair the permitted uses of surrounding properties. If necessary, measures will be taken to minimize potential negative effects on adjacent forest lands."

Finding 4: The proposed mining operation will be limited to an area of approximately 120 acres. The overall land use pattern of the area is the adjacent mining operation and other Watters land to the north, industrial uses to the east, vacant rocky land to the south, and farm and residential lands to the west. The following measures are being recommended to minimize potential negative effects of the mining on nearby properties and uses: the setbacks required by Section 1044.4 should be observed. This should permit the proposed surface mining to fit into the area with minimum disruption of uses on surrounding properties.

Continuing with Section 504 of the Zoning Ordinance:

- ".4 The use does not constitute an unnecessary fire hazard, and provides for fire safety measures in planning, design, construction, and operation."

Finding 5: The mining operation itself will not be a fire hazard, and there will be a water truck on the site could be used to help fight fires in the area.

Continuing with Section 504 of the Zoning Ordinance:

".5 Public utilities are to develop or utilize rights-of-way that have the least adverse impact on forest resources. Existing rights-of-way are to be utilized wherever possible."

Finding 6: There will be no need for public utilities.

Continuing with Section 504 of the Zoning Ordinance:

".6 Development within major and peripheral big game ranges shall be sited to minimize the impact on big game habitat. To minimize the impact, structures shall: be located near existing roads; be as close as possible to existing structures on adjoining lots; and be clustered where several structures are proposed."

Finding 7: All of Columbia County is a big game range, either prime or peripheral. The mining operation will unavoidably disturb any big game in the area, although the proximity of urban areas will limit the number of big game. There will be no new structures.

"1503 Conditional Uses:

.5 Granting a Permit: The Commission may grant a Conditional Use Permit after conducting a public hearing, provided the applicant provides evidence substantiating that all the requirements of this ordinance relative to the proposed use are satisfied and demonstrates the proposed use also satisfies the following criteria:

A. The use is listed as a Conditional Use in the zone which is currently applied to the site;"

Finding 8: The PF-76 zone lists "Operations conducted for the exploration, mining and processing of...aggregate, and other mineral or subsurface resources not permitted outright" under "Conditional Uses."

Continuing with Zoning Ordinance Section 1503.5:

"B. The use meets the specific criteria established in the underlying zone:"

Finding 9: See Findings 1 through 7 above.

Continuing with Zoning Ordinance Section 1503.5:

"C. The characteristics of the site are suitable for the proposed use considering size, shape, location, topography, existence of improvements, and natural features;"

Finding 10: The property is located immediately southwest of the existing mining pit. It is 185 acres, is irregular in shape, and the topography is rugged and rocky. There are no existing improvements on the property. Natural features are the rocky terrain and small trees and grasslands. There is evidence of high quality basalt to a depth of at least 300', which indicates a quantity of about 30 million tons on the proposed mining site. These appear to make the site suitable for the proposed aggregate mine.

Continuing with Zoning Ordinance Section 1503.5:

"D. The site and proposed development is timely, considering the adequacy of transportation systems, public facilities, and services existing or planned for the area affected by the use."

Finding 11: The only transportation systems in the area are Pittsburg Road and Highway 30. Public facilities and services, existing or planned, in the area, consist of telephone and electric power. These appear to make the proposed residence timely.

Continuing with Zoning Ordinance Section 1503.5:

"E. The proposed use will not alter the character of the surrounding area in a manner which substantially limits, impairs, or precludes the use of surrounding properties for the primary uses listed in the underlying district;"

Finding 12: Properties around the subject property range from 1.03 to 83.95 acres and are being used for industrial, mining, small homestead and farm uses. The city limits of St. Helens are immediately south of the subject property, although the mining operation will stay north of the Urban Growth Boundary, which will keep it a minimum of about 1000' north of Pittsburg Road. The only farm operation in the area appears to be on a 21.25 acre parcel to the west, which is inside the city limits of St. Helens.

The character of this area should not be altered; a part of it is simply expanding and will eventually come quite close to the surrounding uses. If the setbacks of Section 1044.4 of the Zoning Ordinance are observed, there should be very little effect on the surrounding area.

Continuing with Zoning Ordinance Section 1503.5:

"F. The proposal satisfies the goals and policies of the Comprehensive Plan which apply to the proposed use;"

The following goal is in the FOREST LANDS section of the Columbia County Comprehensive Plan (p. 18):

"GOAL: To conserve forest lands for forest uses."

Finding 13: The above goal would not seem to apply to this operation, as 85% of the property is rock outcrops with pockets of shallow soils with no Douglas-fir site index and no timber producing value. Predominant vegetation is white oak, poison oak, grasses and a few douglas-fir, white fir and alder trees.

This and other Comprehensive Plan Goals and Policies are discussed fully in pages 11-16 of the application document.

Continuing with Zoning Ordinance Section 1503.5:

"G. The proposal will not create any hazardous conditions."

Finding 14: The proposed mine may be hazardous, as any quarry creates a pit with sloping or near-vertical walls. The operator will need to fence and post warning signs on the perimeter of the property to keep children and others off the property and away from the edges of the pit.

Continuing with Zoning Ordinance Section 1503:

".6 Design Review: The Commission may require the Conditional Use be subject to a site design review by the Design Review Board."

Finding 15: A Site Design Review may be required by the Planning Commission.

COMMENTS:

1. The St. Helens CPAC approved this application and agreed with staff suggested conditions 1, 2 and 3 as set forth below.

2. No other comments have been received from adjacent and nearby property owners or government agencies as of the date of this staff report (July 17, 1992).

CONCLUSION AND RECOMMENDATION:

Based on the above findings, staff recommends approval of this request, with the following conditions:

1. All crushing and processing operations will be kept on the existing quarry site.
2. All gravel truck traffic, and logging trucks when needed, shall continue to use the present access to Highway 30; only small trucks and autos may enter the site from Pittsburg Road for maintenance and other purposes not directly related to the mining operation.
3. The operator shall fence the entire 130 acre area and post it with warning signs, to prevent people and animals from falling into the pit. *posts set*
4. The operating standards in Sections 1044-1046 of the Zoning Ordinance shall apply to this Permit, as if the land were zoned Surface Mining. *
5. The operator shall obtain an operating permit as required by the Columbia County Surface Mining Land Reclamation Ordinance, as amended, before commencing any mining operation in the subject area.

NOTE: No portion of this property has been identified as wetland on the state-wide wetlands inventory, nor is any of it in an identified floodplain.

Jen

COLUMBIA COUNTY
LAND DEVELOPMENT SERVICES

COURTHOUSE
ST. HELENS, OREGON 97051
PHONE (503) 397-1501

August 5, 1992

J.H. & D., Inc.
Watters Concrete, Inc.
P.O. Box 405
St. Helens, OR 97051

Dear Sirs:

Re: Conditional Use Permit CU 22-92

As you know, the Planning Commission approved the above permit, but with somewhat different conditions than were suggested in the staff report. It is my understanding that the conditions imposed by the Commission were as follows:

1. Small crushers may be used at the excavation areas, plus conveyors to take the rock to the main crusher on the present quarry site.
2. All gravel truck traffic, and logging trucks when needed, shall continue to use Highway 30 for access to the quarry, the exact location to be determined by ODOT from time to time; only small trucks and autos may enter the site from Pittsburg Road for maintenance and other purposes not directly related to the mining operation.
3. The operator shall fence each area of excavation and post it with warning signs, to prevent people and animals from falling into the pit; the perimeter of the property need not be fenced. The fence around each excavation area shall be a cyclone fence with the posts set in concrete.
4. The operating standards in Sections 1044-1046 of the Zoning Ordinance shall apply to this Permit, as if the land were zoned Surface Mining.
5. The operator shall obtain an operating permit as required by the Columbia County Surface Mining Land Reclamation Ordinance, as amended, before commencing any mining operation in the subject area.

Please contact me if any of the above is not clear or you feel it is in error. Thank you.

Sincerely,



Peter Watson, Planner II

Attachment C

DOGAMI Operating Permit

*Oregon Dept. of Geology & Mineral Industries
Mineral Land Regulation & Reclamation Program
229 Broadalbin St. SW
Albany OR 97321-2246
(541) 967-2039*

**OPERATING PERMIT w/Limited Exemption Acres -- Renewal
ISSUED SUBJECT TO ANY LISTED CONDITIONS**

Knife River Corp. NW - Tangent
32260 Old Highway 34
Tangent OR 97389-9770

ID No.: 05-0018
Site Name: Watters Quarry & Mill
County: Columbia
Twp R S TL: 5N1W32 100, 5N1W32 1600,
5N1W33 300, 5N1W33 400

This permit shall be in effect, unless revoked or suspended for cause, from the date of issuance and shall remain in effect so long thereafter as the Permittee pays the annual fee to renew the permit, complies with the provisions of ORS 517.750 through 517.955 as applicable, the Rules as promulgated to administer the Oregon Mined Land Reclamation Act, the approved reclamation plan, and any conditions attached to this permit, and maintains a performance bond as required by the Act.

Issuance of this permit is not a finding of compliance with state-wide planning goals or the acknowledged comprehensive plan. The applicant must receive land-use approval from local government before using this permit.

NOTE: Reclamation plans may be modified per ORS 517.831 and OAR 632-(030) and (035)-0035.

CONDITIONS: (Conditions may be appealed per OAR 632-030-0056 or OAR 632-035-0050. If an appeal is made, this permit is invalid until the condition(s) appealed is/are resolved and the permit reissued.)

The Permittee must:

1. submit a plan for DOGAMI approval within 1-year of permit issuance that defines the creation of a lake with shallows and an irregular shoreline bordered by wetland areas. The plan shall include map(s) and a narrative illustrating placement of growth medium, planting species, plant density and a weed control plan.
2. not conduct pit dewatering without first amending the DOGAMI permit.
3. agree that if mining operations disturb any area outside of the permit area or area designated for active mining in the reclamation plan, including but not limited to disturbances caused by landslide, erosion or fly rock, the operator must restore the disturbed area to a condition that is comparable to what it was prior to the disturbance. Further, if areas outside of the permit boundary or outside of the area proposed for active mining in the reclamation plan are disturbed, DOGAMI may increase the amount of the required bond or approved alternative form of financial security to cover the cost of such restoration.
4. maintain a 50-foot setback from Liberty Hill Road; no property line setback for mining is required along the boundary with the adjacent Ross Quarry (05-0083), as approved under County variance V 13-05.

Issued October 17, 2023



Vaughn Balzer
Reclamationist

RENEWAL IS REQUIRED BY SEPTEMBER 30, 2024

c: Columbia County Planning Department

Attachment D

Compensatory Mitigation Plan



April 2024
Watters Quarry Phase II Project



Compensatory Mitigation Plan

Prepared for Knife River Corporation – Northwest

April 2024
Watters Quarry Phase II Project

Compensatory Mitigation Plan

Prepared for
Knife River Corporation Northwest
32260 Old Highway 34
Tangent, Oregon 97389

Prepared by
Anchor QEA, LLC
6720 S Macadam Avenue, Suite 300
Portland, Oregon 97219

TABLE OF CONTENTS

1	Introduction	D-1
1.1	Overview	D-1
1.2	Ecological Goals and Objectives.....	D-1
1.3	Description of Compensatory Mitigation Plan	D-3
1.3.1	Hydrology Studies.....	D-3
1.4	Summary of Mitigation Acreages by Wetland Classes and Mitigation Method	D-10
1.5	Summary of Losses and Gains of Functions and Values.....	D-14
2	Compensatory Mitigation Plan Information.....	D-17
3	Compensatory Mitigation Plan Principal Objectives	D-18
3.1	Functions and Values Replacement	D-18
3.2	Self-Sustaining or Minimum Maintenance Needs	D-18
3.3	Siting Considerations.....	D-18
3.4	Minimize Temporal Loss.....	D-21
4	Existing Site Conditions.....	D-22
4.1	Existing Wetland Habitat.....	D-22
4.2	Existing Upland Habitat	D-22
4.2.1	Mixed Forest.....	D-22
4.2.2	Mixed Woodland	D-23
4.2.3	Mixed Woodland/Grassland.....	D-23
4.2.4	Shrub and Shrub/Grassland	D-24
4.2.5	Grassland	D-24
4.2.6	Grassland/Prairie.....	D-24
4.2.7	Mitigation Area Upland Habitat	D-25
4.3	Impact Site	D-25
4.4	Mitigation Areas and Remaining Wetlands and Streams.....	D-26
4.5	Factors Leading to Degraded Condition.....	D-27
4.6	Means for Reversal of Degradation	D-27
5	Functions and Values Assessment.....	D-28
5.1	Functions and Values Assessment Methods.....	D-28
5.2	Functions and Values Results	D-33
5.3	Summary of Change at the Impact Site	D-33
5.4	Summary of Existing Functions and Values	D-33

5.5	Summary of Post-Construction Compensatory Mitigation Creation	D-35
5.6	Functions and Values Replacement	D-35
6	Compensatory Mitigation Design Construction	D-41
6.1	Design Considerations	D-41
6.2	Grading Plan.....	D-42
6.2.1	Central Basin.....	D-43
6.2.2	Western Basin	D-48
6.3	Planting Plan	D-49
6.4	Construction Schedule	D-55
7	Monitoring Plan	D-57
7.1	Goals, Objectives, and Performance Standards.....	D-57
7.2	Monitoring Method.....	D-61
7.3	Monitoring Schedule	D-61
7.4	Rationale for Plot and Photograph Documentation Locations	D-62
8	Long-Term Protection and Financial Security Instruments	D-63
8.1	Proposed Protection Instrument.....	D-63
8.2	Proposed Financial Security Instrument.....	D-63
8.3	Long-Term Management Plan	D-64
8.3.1	Anticipated Long-Term Ownership and Maintenance Actions	D-64
8.3.2	Entity Responsible for Maintenance	D-64
8.3.3	Anticipated Funding Source.....	D-64
9	References	D-65

TABLES

Table 1	Surface Hydrology Peak Flow and Runoff Volume Summary
Table 2	Subsurface Hydrology Groundwater Volume by Water-Bearing Zone Summary
Table 3	Mitigation Eligibility Determination Summary
Table 4	Mitigation Accounting Determination Summary
Table 5	Proposed Project Wetland and Stream Impacts
Table 6	Impact Site and Compensatory Mitigation Wetland and Stream Areas Summary
Table 7	Proposed Project Site Information
Table 8	Wetland Functions and Values Assessed by the Oregon Rapid Wetland Assessment Protocol (ORWAP)

Table 9	Stream Functions and Values Assessed by the Oregon Stream Function Assessment Method (SFAM)
Table 10	Pre- and Post-Project Average ORWAP Scores for Slope and Slope/Depressional Wetlands
Table 11	Pre- and Post-Project Average ORWAP Scores for Depressional/Depressional Outflow and Slope/Depressional Wetlands
Table 12	Pre- and Post-Project Average ORWAP Scores for Slope/Depressional Outflow Wetlands
Table 13	Pre- and Post-Project Average ORWAP Scores for ARSC Wetlands ¹
Table 14	Pre- and Post-Project Average SFAM Scores for Streams
Table 15	Upper Central Basin Contributing Peak Flow and Runoff Volume Summary
Table 16	Upper Central Basin Contributing Average Monthly Flow
Table 17	HEC-RAS Modeled Flow Rates for Mitigation Design
Table 18	Native Woody Species Plantings for Forested and Scrub-Shrub Wetlands
Table 19	Native Herbaceous Species Plantings for Emergent and Wet Prairie/Wet Rock Outcrop ARSC Wetlands
Table 20	Woody Native Species Plantings for Riparian Areas
Table 21	Potential Plant and Seed Nurseries
Table 22	Mitigation Goals, Objectives, and Performance Standards

FIGURES

Figure 1	Vicinity Map
Figure 2	USGS Topography Map
Figure 3	Compensatory Mitigation Plan Overview Map
Figure 4	Drainage Basin and Groundwater Flow Map
Figure 5	Proposed Stream Channel Design Flow Hydrographs
Figure 6	Wetland Delineation Map
Figures 7a-7f	Mitigation Planting Plan
Figure 8	Habitat Mapping
Figure 9	2014 NAIP Imagery
Figure 10a	Reclamation Plan
Figure 10b	Reclamation Plan Cross Sections A-A' and B-B'

APPENDICES

Appendix A	Groundwater Elevation Maps
Appendix B	Wetland and Stream Functions and Values Assessment Report
Appendix C	Post-Project Wetland Functions and Values Assessment Results
Appendix D	HEC-RAS Modeling Results
Appendix E	Grading Plan
Appendix F	Example Deed Restriction
Appendix G	DSL Payment Calculator for In-Lieu Fee Programs
Appendix H	Lease Renewal

ABBREVIATIONS

ARSC	Aquatic Resource of Special Concern
BMP	best management practice
cfs	cubic feet per second
County	Columbia County, Oregon
CRBG	Columbia River Basalt Group
DEQ	Oregon Department of Environmental Quality
DOGAMI	Oregon Department of Geology and Mineral Industries
DSL	Oregon Department of State Lands
ESH	Essential Indigenous Anadromous Salmonid Habitat
FAC	facultative
FACU	facultative upland
FACW	facultative wetland
GRB	Grande Ronde Basalt
H:V	horizontal to vertical
HEC-RAS	Hydrologic Engineering Center River Analysis System
HGM	hydrogeomorphic
HUC	hydrologic unit code
JPA	joint permit application
Knife River	Knife River Corporation – Northwest
N/A	not applicable
NRCS	Natural Resources Conservation Service
OAR	Oregon Administrative Rule
OBL	obligate wetland
ORWAP	Oregon Rapid Wetland Assessment Protocol
PEM	palustrine emergent
PFO	palustrine forested
Plan	<i>Compensatory Mitigation Plan</i>
project	Watters Quarry Phase II project
project site	Property in Columbia County, Oregon leased from Weyerhaeuser NR Company
PSS	palustrine scrub-shrub
R4RB1	riverine, intermittent, rock bottom, bedrock
SFAM	Oregon Stream Function Assessment Method
TESC	temporary erosion and sediment control
USACE	U.S. Army Corps of Engineers
WBZ	water-bearing zone

1 Introduction

1.1 Overview

This Compensatory Mitigation Plan (Plan) has been prepared following the requirements outlined in Oregon Administrative Rule (OAR) Chapter 141 Division 085. The purpose of this Plan is to compensate for the 0.39 acre of direct permanent palustrine emergent (PEM), 4.09 acres of direct permanent palustrine forested (PFO), 5.66 acres of direct permanent PFO/PEM wetland impacts, and 1.42 acres of potential indirect permanent PFO/PEM wetland impacts (11.56 total acres) associated with the Watters Quarry Phase II project (project). Of the 0.39 acre of PEM direct impact, 0.35 acre consists of wetlands that have been identified as Aquatic Resources of Special Concern (ARSC), which will also be compensated for with implementation of the Plan. Of the 1.42 acres of PFO/PEM potential indirect impacts, approximately 0.26 acres consists of ARSC wetlands that will also be compensated for with this Plan. In addition, the Plan describes compensatory mitigation for 0.002 acre of direct permanent impacts and 0.058 acre of potential indirect permanent impacts to intermittent streams.

Knife River Corporation—Northwest (Knife River) currently leases property in Columbia County, Oregon (County), for mining use from the landowner, Weyerhaeuser NR Company (project site; Figure 1). The project would allow the existing active aggregate mining area (Watters Quarry Phase I) located immediately north of the Phase II area to continue. The existing mine began operations before 1953. A conditional use permit for the project was approved by the County in 1992, adding an additional 120 acres of mining land to the existing quarry site. The proposed quarry (Phase II area) would provide high-quality aggregate over an approximately 50-year period, pending market demand. Once the existing active mining area (Phase I) has been exhausted of the remaining aggregate reserves, Phase II would proceed south under Liberty Hill Road and into the project site to the south and west. The project also includes on-site compensatory mitigation for unavoidable impacts to wetlands and streams. The U.S. Geological Survey quadrangle topographic map of the project site is provided in Figure 2.

1.2 Ecological Goals and Objectives

The goal of this Plan is to compensate for lost functions of impacted wetlands and streams with the successful creation of 18.32 acres of compensatory wetland mitigation that exceeds the 17.34 acres of wetland mitigation credits required (Figure 3). The Plan also includes 1.12 acres of perennial stream¹ creation that exceeds the 0.09 acre of stream mitigation credits required (Figure 3). In addition to wetland creation, some enhancement of existing wetlands will also occur as part of the overall mitigation strategy. Enhancement is not accepted by the agencies as mitigation and is not

¹ The perennial stream in this instance is a stream that flows at least 8 months every year or has continuous flow in parts of its bed all year long during years of normal precipitation.

included in the compensatory mitigation acreage; however, enhancement of these existing wetland areas is proposed to aid in achieving the overall goal of establishing a diverse, native wetland plant community consisting of a forested canopy, scrub-shrub subcanopy, and herbaceous layer with few invasive species. Enhancing wetlands adjacent to the created mitigation wetlands through invasive species removal and native plantings will increase the effectiveness and overall goal of the Plan. Mitigation components outlined in this Plan include an evaluation of wetland and stream functions and values replacement; a grading plan; a temporary erosion and sediment control (TESC) plan that includes best management practices (BMPs) during construction; a planting plan; and a discussion of performance standards, maintenance requirements, contingency measures for adaptive management, and a monitoring plan.

The main objective of the Plan is to replace impacted wetland and stream functions by creating similar and higher functioning habitats than those impacted. Wetland habitat types to be created will include wetland forested, scrub-shrub, and emergent communities, including the creation of "Wet Rock Outcrop" wetlands which are considered a wetland subset of "Wet Prairie." Both of these wetland types are classified as ARSC under OAR 141-085-510(3), to compensate for similar types of impacted wetlands. ARSC wet prairies usually occur at lower elevations on flat or depressional terrain consisting of bedrock or clay loam soils with irregular surfaces that have a seasonally perched water table with an intermittent to seasonally flooded water regime (OSU 2023). These wetlands typically dry out by late spring, but depressions may retain water into the summer months. Shallow soils over bedrock, and rock outcrop habitats are included as part of wet prairie habitat because they are often intermixed with clay soil sites, and the same vegetation may occur in both wetland habitat types (OSU 2023).

Plant species selection was based on species historically known to occur in the area and those currently present on the project site and impact area. These plant species are typical of forested, scrub-shrub, and emergent wetlands, and wet rock outcrop wetlands in the region. A 50-foot vegetated corridor will be established around the remaining existing and created wetlands and streams, providing a protective buffer between the wetlands and the mining site. For areas where a 50-foot buffer is not feasible (e.g., proximity to other wetlands), additional buffer will be added in other areas to achieve a 50-foot average buffer for the entire site. These vegetated areas will protect wetlands and streams from quarry activities and enhance overall wetland and stream functions. Existing upland trees, scrub-shrub, and herbaceous communities on slopes adjacent to the wetland and stream creation areas will be preserved to the extent practical that still allows successful implementation of the Plan. Most high value habitat areas adjacent to the mitigation areas will be avoided and preserved in perpetuity. In addition, native trees, shrubs, and forbs/grasses will be planted in graded areas and riparian zones lacking sufficient native vegetation. Implementation of this Plan will provide high-quality habitat for a wide variety of wildlife species.

1.3 Description of Compensatory Mitigation Plan

Plan implementation will compensate for unavoidable impacts to wetlands and streams in the quarry footprint and replace locally important ecological functions and services that will be permanently lost. Once all required permits for the project are issued, construction of the mitigation features identified in the Plan will begin before most direct impacts to wetlands and streams would occur. The exception is that hydrology to some wetlands would be altered by redirecting that hydrology to created wetland and stream areas. The majority of the proposed stream channel will be graded and prepared prior to redirecting hydrology from the existing perennial stream into the created stream channel. The purpose of this approach is to ensure the created stream channel is functioning as designed (i.e., direct precipitation is flowing in the stream channel during rain events) prior to altering any hydrology to the existing wetlands in the mining site.

Success of wetland mitigation is primarily based on achieving adequate hydrology. Hydrology for many of the created wetlands will come from capturing direct precipitation overland flow, and shallow groundwater (i.e., the water table is perched on bedrock that varies from the surface to a few feet below ground surface in some areas) interception similar to the predominant hydrology sources for the existing wetlands. Because the site is underlain with basalt bedrock, water running onto the site and direct precipitation either ponds in bedrock depressions or flows across the site either on the surface or along the bedrock slightly below the ground surface. Wetlands primarily reliant on direct precipitation are formed on shallow soils over impermeable bedrock. Seasonal rains “pond” in bedrock depressions and allow wetland conditions to persist in the shallow soils. The wetland mitigation areas will be graded to create depressional areas on the bedrock with topsoil spread over these areas providing conditions similar to the existing wetlands.

1.3.1 Hydrology Studies

Hydrology will also come from redirecting surface and shallow subsurface flow identified from observations and analyses of on-site surface hydrology and a 36-month subsurface water monitoring study of the area from June 2020 to May 2023. The locations of installed piezometers, drainage basins, surface flow accumulation, and subsurface flow direction are included in Figure 4.

1.3.1.1 Surface Hydrology Analysis

ArcGIS watershed tools were used to delineate surface water runoff basins for the site. Figure 4 shows the larger basins where peak flow volumes are the most significant. Available survey data were used for site topography. For areas where adequate survey data were not available, LiDAR data (Terrapoint 2005) were used. The combined data were used to establish flow direction and determine areas where flow is expected to accumulate in each basin (topographic low points). Locations calculated as having high flow accumulation would expect to have relatively defined channels where surface water would collect. These accumulation areas were used to estimate 24 surface water outlet

locations where accumulated flow leaves the site. Site topography data were used to develop surface water runoff basins for each surface outlet location. This study assisted the mitigation design in terms of establishing peak flow estimates and average monthly flow estimates primarily for the northern portion of the Central Basin that conveys flow into the perennial stream (Perennial Stream 1-A) entering the site from the north and currently flows towards and through Wetland M and into Intermittent Stream B.

The surface hydrology study shows that most of the hydrology supporting Wetlands B and C originates upslope from the proposed mitigation areas (Figure 4). The upslope surface hydrology feeding the western portion of Wetland B in the Western Basin will not be impacted by the proposed mitigation plan. Most of the surface hydrology feeding Wetland C also originates from upslope in the Western Basin, including runoff from the western portion of Wetland B (Figure 4). Creation of the mitigation areas in the Western Basin will require grading around but outside the boundaries of Wetland C and the western portion of Wetland B. Berms between these existing wetlands and the grading areas will be installed to avoid potential indirect effects. The southern portion of Wetland M-3 is located in an area that contributes very little surface hydrology to Wetland C and therefore its creation is not anticipated to affect its hydrology.

The upslope surface hydrology feeding the eastern portion of Wetland B in the Central Basin will not be impacted by the proposed mitigation plan. Berms between this portion of Wetland B and the grading areas will be installed to avoid potential indirect effects to Wetland B. Under existing conditions, surface hydrology from Wetland B flows to the northeast and east. During high precipitation events, surface hydrology from the eastern portion of Wetland B and surface hydrology from Perennial Stream 1-A flows south towards Wetland M. The proposed grading plan would capture this flow, route it around the mining area, and maintain the hydrology of the Central Basin. Additional berms between the remaining wetlands and created areas will also be installed to avoid potential disturbance, as well as along the mining boundary to avoid potential effects from mining activities. Construction of the Phase II mining area is not anticipated to impact the surface hydrologic sources for the remaining wetlands and other waters on the project site. The primary source of hydrology to the remaining wetlands is precipitation, with secondary sources of overland flow and shallow groundwater. Creation of the proposed stream channel is designed to reroute surface flow from Perennial Stream 1-A into the created areas that would otherwise flow through Wetland M. During high precipitation events, this flow would contribute overland flow to the remaining wetlands.

An additional hydrologic study was completed to size the proposed stream channel (Perennial Stream MS-1) to sufficiently carry flows from the existing Perennial Stream 1-A and surrounding upland areas. An estimate of the area draining to the proposed stream channel was developed by adjusting the surface water runoff basins to account for grading of the proposed mitigation design and development of the Phase II mining area. A spreadsheet analysis using the Santa Barbara Unit

Hydrograph method was prepared to estimate flow hydrographs for peak flow and runoff volume events. These analyses used guidance from the Columbia County Stormwater & Erosion Control Ordinance (2001) for peak flow and runoff volumes for four events: the water quality event (defined as the peak flow rate associated with the water quality design storm), 2-year event, 10-year event, and 100-year event. Soil type and land cover were used to develop a curve number of 81.5, which, along with the basin area of 97.3 acres, was one of the driving factors in analyzing the peak flow and runoff volumes for the proposed stream channel. Table 1 summarizes the peak flows and runoff volumes for the area draining to the proposed stream channel. Corresponding design flow hydrographs are shown in Figure 5.

Table 1
Surface Hydrology Peak Flow and Runoff Volume Summary

Parameter	Water Quality Event	2-Year Event	10-Year Event	100-Year Event
24-hour Precipitation (inches)	0.67	2.00	3.00	4.00
Peak Flow (cubic feet per second)	0.242	5.26	15.23	27.42
Runoff Volume (cubic feet)	6,630	221,230	475,400	763,620

Note:
Peak flow and runoff volumes derived from a curve number of 81.5 and a basin area of 97.3 acres.

1.3.1.2 Subsurface Hydrology Analysis

The approximate lateral extents of monthly groundwater elevations for the various water-bearing zones across the project site are provided in Appendix A, Figures A-1 through A-36. Piezometer data collected over the 36-month study was used to establish approximate groundwater elevations and lateral extents in 14 water-bearing zones (WBZs) within the site. Eight of the WBZs were determined by data from the piezometers. The other 6 WBZs were estimated based on occurrence of wetlands or topographic depressional areas where there was no piezometer data. The groundwater elevations in the 6 WBZs without piezometer elevation data were estimated by comparing to nearby piezometer data. The 14 WBZs were delineated into groundwater basins determined by topography and groundwater flow directions. ArcGIS was used to calculate the monthly groundwater volume of the lateral and vertical extent of each WBZ using the thickness from the top of bedrock to the groundwater surface. These volumes were then multiplied by an assumed saturated soil porosity of 30% to account for the ratio of the volume of voids to the total volume of the soil. Table 2 summarizes the minimum, average, and maximum groundwater volumes estimated for each WBZ for the 36-month subsurface water monitoring study.

The groundwater that accumulates in the WBZs within the mining area in the Central Basin would be intercepted by the proposed mitigation design and directed to mitigation areas through site grading and placement of clay or similar material if fissures are encountered or form. Some of the groundwater volume estimated for the PZ4 WBZ would be similarly captured and routed into the depressional areas of Wetland M-3. As shown in Table 2, PZ1 WBZ and PZ4 WBZ contain the largest total volume of groundwater. That volume, combined with the rerouted groundwater in the WBZs within the mining area in the Central Basin would provide sufficient sources of hydrology to the created mitigation areas in addition to direct precipitation and overland flow.

The subsurface hydrology study shows consistent WBZs during most of the year in Wetlands B and C (Figures A-1 through A-36 in Appendix A) due to existing topography and groundwater flow directions (Figure 4). Groundwater accumulates at the eastern end of Wetland B and in areas downslope from Perennial Stream 1-A. Some of this subsurface hydrology flows towards Wetland M. The proposed grading plan is designed to maintain the subsurface hydrology in Wetlands B and C. Any potential fissures or cracks that are encountered or form during grading will be sealed with clay or similar impervious material to prevent any potential groundwater effects to Wetlands B and C or the other remaining wetlands on the project site. Construction of the Phase II mining area is not anticipated to impact subsurface hydrology in the remaining wetlands and other waters on the project site. The 36-month groundwater study shows that the water-bearing zones (WBZ6 and WBZ3) for the remaining wetlands downslope from the mining area are relatively confined to the boundaries of the existing wetlands throughout the year. These data suggest that the existing depressional wetlands mainly capture precipitation with only minor amounts of contributing overland flow to the WBZs. It is anticipated that with the creation of the mitigation areas, the remaining wetlands would have an additional source of subsurface hydrology from shallow groundwater flow from created Perennial Stream MS-1 and associated wetland fringe (Wetland M-1) during the wet season.

These studies informed the mitigation design in terms of establishing surface water flow direction and quantity and subsurface water elevations, flow direction, and quantity. Most of the surface and subsurface hydrology originates upslope from the proposed mitigation areas from wetlands and hillsides that will not be impacted by the proposed project. The hydrology that currently flows from the perennial stream entering the site from the northwest flows through Wetland M during high flows and exhibits no flow during late fall and subsurface flow in several places all year. After grading of the mitigation stream channel is completed and flow has been verified during storm events, flow will be intercepted upslope and, prior to Wetland M, directed around the proposed mine site in the created stream channel and then reconnected to the current outlet channel (Intermittent Stream B) within Wetland M. Excavated areas for some of the created mitigation wetlands will be developed adjacent to the redirected flow and will be backfilled with clay or similar materials if needed to prevent captured water from infiltrating any potential fissures in the bedrock during storm events,

resulting in ponded conditions similar to existing wetlands. However, the basalt in the project site is of high quality and “tight,” meaning few, if any, fissures are expected to be encountered. Based on quality testing results, the basalt meets and exceeds the restrictive quality standards as an Oregon Department of Transportation Asphalt Concrete Pavement rock source, and most of the rock is aphanitic (i.e., very fine-grained) to finely vesicular. Hydrologic conditions and soil depths will be created similar to existing conditions to achieve self-sustaining wetland hydrology in the mitigation design.

The proposed mitigation design captures the existing hydrology feeding the wetlands proposed to be impacted by the project and is designed to create wetlands similar to those impacted. Specifically, the project would redirect hydrology in two basins (Central Basin and Eastern Basin; Figure 4). Eastern Basin hydrology within the project footprint is from direct precipitation and will be captured and treated before exiting the project site, similar to the hydrology in the existing mine to the north. To compensate for wetland impacts in this basin, hydrology that flows through Wetland C and discharges through a perched pipe in the Western Basin (Figure 4) and intercepted subsurface water will be captured and used to create additional PFO, palustrine scrub-shrub (PSS), and PEM wetland complexes, similar to the wetlands impacted in the Eastern Basin.

The source of hydrology for the Central Basin is from the hillsides to the north of the project site (Figure 4). This hydrology feeds Wetland M, the largest wetland proposed to be impacted in this basin. The hydrology will be intercepted and routed around the mining area, creating a stream and wetland complex similar to the existing Wetland M. The stream and wetland complex will route around the mining area and then tie into the existing lower portion of Wetland M that is outside of the mining area, maintaining the hydrology of the basin, the existing point of discharge, and the external contribution to the basin. The remaining existing wetlands located outside of and downslope of the mining area within the Central Basin will continue to receive precipitation and surface and shallow subsurface hydrology from upslope areas. Most of the basalt rock on the project site is aphanitic (i.e., very fine-grained) to finely vesicular (i.e., “tight”) and consists of the Sentinel Bluffs Member and the older Winter Water Member of the Grande Ronde Basalt (GRB) of the Columbia River Basalt Group (CRBG). The shallowest non-basalt contact band between these CRBG geologic units on the project site is at a depth of 83 feet below ground surface, and any hydrology along that contact is not likely supporting wetland hydrology at that depth. Other joints or discontinuities within the CRBG geologic units likely have clay, zeolite, or accumulations of decomposed rock materials. Under existing conditions, the majority of the Central Basin hydrology within the mining footprint flows into Wetland M and off site through Intermittent Stream B without reaching the off-site wetlands south of the project site. Since much of the hydrology in the Central Basin will be rerouted around the mining area and maintained in the basin, it is assumed that most upslope surface and shallow subsurface hydrology feeding the off-site wetlands will be sustained by the Plan.

To create the mitigation wetlands, soil and rock will be excavated from select areas on the project site to depths that allow for seasonal rain events to spread out and be retained to support palustrine wetland vegetation communities (Figure 3). Mitigation wetland area preparation will occur prior to seeding and planting. The mitigation wetland areas have been designed to support diverse native plant species, including those that would be impacted by the proposed mining activities. Hydrology observations will be made during mitigation wetland area preparation to inform adjustments to the planting plan, as needed, and to facilitate establishment of appropriate species. Adaptive management (e.g., adjustments to grading, addition of clay if fissures are encountered or form, soil placement and removal) based on best available science will occur to maximize the success of the Plan. Adjustments to the grading plan may include changing mitigation area elevation (i.e., raise or lower) and adjusting microtopography to successfully hold adequate hydrology for the hydroperiod being created. This may also include adding woody debris or check dams to help retain or slow flow. To ensure the success of plant survivorship, soil thickness may be adjusted or amended as necessary, or other species that would be better adapted for the site may be planted. Plant communities would also be assessed to ensure successful diversity to support the Cowardin class being created. The methods for invasive species control may need to be modified depending on how site conditions develop. If plants in the mitigation areas show signs of heavy browse or other damage from wildlife planting, tubes may be installed, or other control measures, such as fencing or biological repellants, may be implemented. Prescriptive erosion control methods (e.g., mulch, straw wattles) may also be implemented beyond initial construction BMPs, should conditions warrant.

Table 2
Subsurface Hydrology Groundwater Volume by Water-Bearing Zone Summary

Water-Bearing Zone	Groundwater Volume (Gallons)							
	Minimum		Average		Maximum		Total	
	Dry Season	Wet Season	Dry Season	Wet Season	Dry Season	Wet Season	Dry Season	Wet Season
Central Basin								
PZ1 WBZ	3,063,534	2,922,031	4,063,014	5,277,649	5,800,130	5,971,383	48,756,164	126,663,579
PZ6 WBZ	105,379	73,667	349,081	471,551	580,450	656,590	4,188,966	11,317,225
PZ7 WBZ	0	0	258,278	363,457	731,884	548,778	3,099,331	8,722,966
PZ9 WBZ	126,131	121,955	368,748	913,256	1,102,257	1,406,946	4,424,971	21,918,155
WBZ1	0	0	158,674	280,874	487,502	673,348	1,904,092	6,740,979
WBZ3	0	0	134,141	218,778	356,931	468,222	1,609,695	5,250,683
WBZ4	0	0	781	4,608	7,032	30,181	9,371	110,595
WBZ6	284,570	244,315	1,360,641	1,884,413	2,716,061	3,449,131	16,327,691	45,225,921
WBZ7	77,838	57,652	565,216	815,406	1,126,773	1,525,129	6,782,593	19,569,756
Eastern Basin								
PZ8 WBZ	2,062	1,985	28,392	144,308	166,032	291,762	340,700	3,463,404
WBZ2	0	0	96,707	242,769	495,273	802,031	1,160,487	5,826,452
Western Basin								
PZ2 WBZ	248,379	300,815	491,016	791,401	885,113	954,115	5,892,190	18,993,636
PZ3 WBZ	779,831	720,509	1,402,202	2,463,850	2,151,855	3,258,034	16,826,420	59,132,406
PZ4 WBZ	1,291,182	1,184,286	3,890,210	5,051,616	6,792,677	8,522,039	46,682,524	121,238,786

Note:
Peak flow and runoff volumes derived from a curve number of 81.5 and a basin area of 97.3 acres.

1.4 Summary of Mitigation Acreages by Wetland Classes and Mitigation Method

The eligibility determination results for the proposed mitigation strategy as identified by the Oregon Department of State Lands (DSL) Aquatic Resources Mitigation Framework methodology are provided in Table 3. DSL's Aquatic Resources Mitigation Framework wetland credit compensatory mitigation accounting determination for the mitigation plan is provided in Table 4. A summary of wetland impacts for the project is provided in Table 5. The delineated wetlands for the project site are shown in Figure 6. A summary of impact areas, compensatory mitigation wetland and stream areas, and mitigation method is provided in Table 6. The proposed mitigation planting zones are shown in Figures 7a through 7f, and the planting plan is described in detail in Section 6.3.

The mitigation design will create 18.32 acres of wetlands to offset impacts to 11.56 acres in the proposed quarry area. An additional 1.12 acres of stream will be created as well. This will exceed the required 1.5:1 replacement ratio for creation that was derived from the DSL accounting framework. The joint permit application (JPA) for the project includes impacts to Wetland K, a 0.005-acre PEM, seasonally flooded, Depressional wetland located in the impact area; however, DSL determined that it was not jurisdictional during its review of the wetland delineation report. If the U.S. Army Corps of Engineers (USACE) determines this wetland to be jurisdictional, the mitigation proposed in this Plan provides adequate compensation for impacts even if Wetland K is determined to be jurisdictional.

Table 3
Mitigation Eligibility Determination Summary

Expectation	Criteria: Does the Mitigation Plan Replace All of the Following?	Response	Result
Expectation for providing ecological match for wetlands impacts	a) HGM class(es) and subclass(es)?	Yes	Met
	b) Cowardin system(s) and classes?	Yes	Met
	c) Group-level functions and values?	Yes	Met
Expectation for providing ecological match for stream impacts	d) Flow permanence (intermittent or perennial)?	Yes	Met
	e) Stream size class (small, medium, or large)?	Yes	Met
	f) ESH designation, if the impact is to an ESH stream?	Impact site is not ESH	N/A

Note:
N/A: not applicable

**Table 4
Mitigation Accounting Determination Summary**

Factor		Method 1
Mitigation method	What method(s) of mitigation is proposed?	Creation
	Minimum mitigation requirement (acres of mitigation required per acre of impact)	1.00
Specific function and value replacement (increase factor)	How many specific functions and values from the impact site are replaced at the mitigation site?	≥13 matches
		+0%
Function temporal loss (increase factor)	Which factor, if any, will cause the greatest temporal loss of function?	Deciduous forest impacted
		+50%
High level of function replacement (decrease factor)	Does the compensatory mitigation site exceed at least 80% of the specific functions being lost at the impact site?	No
		+0%
Mitigation site protection and stewardship (decrease factor)	What level of site protection and stewardship is proposed for the mitigation site?	Minimum requirements
		-0%
Total adjustment (percent increase)		50%
Adjusted mitigation requirement (acres of mitigation required per acre of impact)		1.50
Acreage of wetland impact		11.56
Wetland mitigation acreage required (adjusted mitigation requirement x impacted acreage)		17.34
Acreage of stream impact		0.06
Stream Mitigation acreage required (adjusted mitigation requirement x impacted acreage)		0.09
Total mitigation required without buffers		17.43

**Table 5
Proposed Project Wetland and Stream Impacts**

ID	Cowardin Class	HGM	Acres Impacted
Wetland D	PFO	Slope	0.89
Wetland E	PFO	Slope	0.21
Wetland H	PEM	Depressional	0.01
Wetland I	PEM	Depressional	0.002
Wetland J	PEM	Depressional	0.001
Wetland K ¹	PEM	Depressional	0.005
Wetland L	PEM	Depressional	0.05
Wetland M	PFO/PEM	Depressional Outflow	7.08 ²
Wetland N	PFO	Depressional Outflow	2.43
Wetland O	PEM	Depressional	0.06
Wetland P	PEM	Depressional	0.002
Wetland Q	PEM	Depressional	0.004
Wetland R	PEM	Depressional	0.004
Wetland S	PEM	Depressional	0.0002
Wetland T	PEM	Depressional	0.08
Wetland AA	PFO	Depressional	0.22
Wetland BB	PFO	Depressional	0.04
Wetland CC	PFO	Depressional	0.25
Wetland QQ	PEM	Depressional Outflow	0.1
Wetland RR	PEM	Depressional Outflow	0.03
Wetland SS	PEM	Depressional Outflow	0.01
Wetland XX	PEM	Depressional Outflow	0.01
Wetland YY	PEM	Depressional Outflow	0.02
Wetland ZZ	PFO	Depressional	0.05
Total Wetland Impacts			11.56
Intermittent Stream B	R4RB1	N/A	0.045
Tributary to Intermittent Stream B	R4RB1	N/A	0.012
Intermittent Stream C	R4RB1	N/A	0.002
Intermittent Stream D	R4RB1	N/A	0.001
Total Stream Impacts			0.06

Note:

1. DSL has determined that these wetlands and other waters are non-jurisdictional under the Oregon Removal-Fill Law per the wetland delineation concurrence letter for WD #2019-0623, which was issued to the applicant on October 15, 2020 (DSL 2020).
2. Total impacts to Wetland M include 5.66 acres of direct impacts and 1.42 acres of potential indirect impacts.

**Table 6
Impact Site and Compensatory Mitigation Wetland and Stream Areas Summary**

Impact Site			
Existing Feature	Cowardin	HGM	Acres ¹
Wetland M	PFO/PEM	Depressional Outflow	7.08 ²
Wetlands D and E	PFO	Slope	1.10
Wetlands N, AA, BB, CC, ZZ	PFO	Depressional/Depressional Outflow	2.99
Wetlands H, I, J, K, and YY	PEM	Depressional/Depressional Outflow	0.04
ARSC Wetlands L, O, P, Q, R, S, T, QQ, RR, SS, XX	PEM	Depressional/Depressional Outflow	0.35
Total Wetland Impact			11.56
Wetland Mitigation Ratio			1.5:1
Total Wetland Mitigation Required			17.34
Intermittent Stream B	R4RB1	N/A	0.045
Tributary to Intermittent Stream B	R4RB1	N/A	0.012
Intermittent Stream C	R4RB1	N/A	0.002
Intermittent Stream D	R4RB1	N/A	0.001
Total Stream Impact			0.06
Stream Mitigation Ratio			1:1
Total Stream Mitigation Required			0.06
Compensatory Mitigation			
Created ID	Cowardin	HGM	Mitigation Acres
Wetland M-1	PFO/PSS/PEM	Slope/Depressional Outflow	8.88
Wetland M-2	PFO/PSS/PEM	Depressional	0.51
Wetland M-3	PFO/PSS/PEM	Slope/Depressional	7.63
ARSC Wetland M-4	PEM	Depressional	0.34
ARSC Wetland M-5	PEM	Depressional	0.19
ARSC Wetland M-6	PEM	Depressional	0.16
ARSC Wetland M-7	PEM	Depressional	0.04
ARSC Wetland M-8	PEM	Depressional	0.09
ARSC Wetland M-9	PEM	Depressional	0.19
ARSC Wetland M-10	PEM	Depressional	0.29
Total Wetland Mitigation Proposed			18.32
Wetland Credits Gained			0.98
Perennial Stream MS-1	R3RB1	N/A	1.12
Total Stream Mitigation Proposed			1.12
Stream Credits Gained			1.06

Notes:

1. Wetland enhancement is included as part of the overall wetland mitigation strategy of achieving a diverse native plant community with minimal invasives and not included in compensatory mitigation acreage.

2. Approximately 0.26 acre of Wetland M meets the definition of ARSC wetland under OAR 141-085-510(3).

N/A: not applicable | R4RB1: riverine, intermittent, rock bottom, bedrock | R3RB1: riverine, upper perennial, rock bottom, bedrock

1.5 Summary of Losses and Gains of Functions and Values

To determine the losses and gains of wetland functions and values for the proposed project, a wetland functions and values assessment was conducted using the Oregon Rapid Wetland Assessment Protocol (ORWAP), a standardized protocol developed by DSL for rapidly assessing the functions and values of wetlands in Oregon. The full title of the ORWAP manual is *Manual for the Oregon Rapid Wetland Assessment Protocol* (Adamus et al. 2016a), and the supporting website is provided by the ORWAP Map Viewer (Oregon Explorer 2020). ORWAP is applicable to wetlands of any type anywhere in Oregon and can be used to compare different types of wetlands.

The proposed project will impact 24 wetlands on the project site, most of which are less than 0.25 acre in size. Of the wetlands proposed to be impacted, 11 wetlands (Wetlands L, O, P, Q, R, S, T, QQ, RR, SS, and XX) totaling 0.35 acre, meet the definition of “Wet Prairie” or “Wet Rock Outcrop” under OAR 141-085-510(3) (Figure 6). Some emergent portions of Wetland M that are located along the basalt bluff totaling 0.26 acre also meet this definition. To mitigate for these impacts, the Plan proposes to recreate wet prairie habitats (Wetlands M-4, M-5, M-6, M-7, M-8, M-9, and M-10) that will perform at a higher level of functions based on their larger, irregular size and location along the basalt bluff similar to the impacted ARSC wetlands in the proposed mine site; however, most of the existing wetlands are flow-through, to some extent, and the mitigated wetlands will be shallow depressions allowing for wetland characteristics to persist longer. The primary source of wetland hydrology for the created ARSC wetlands would be direct precipitation, with secondary hydrology sources of overland flow and shallow groundwater. Additionally, irregular shaped wetlands tend to promote structural diversity that supports a variety of plant communities and wildlife. The stream and wetland complex (Perennial Stream MS-1 and Wetland M-1) will compensate primarily for the lost functions of Wetland M by creating a perennial stream system with adjacent wetlands similar to the existing intermittent stream system in Wetland M. The perennial stream system will provide increased functions compared to the current intermittent stream system. Created forested, scrub-shrub, and emergent wetland habitats (Wetlands M-2 and M-3) will compensate for impacts to the remaining 12 wetlands (Wetlands D, E, H, I, J, K, N, AA, BB, CC, YY, and ZZ) in the quarry footprint. Using the 1.5:1 calculated mitigation ratio for creation, the mitigation plan will include 1.30 acre or more of Wet Prairie and Wet Rock Outcrop habitats and 17.02 acres of PFO, PSS, and PEM wetland habitats.

Existing wetlands on the project site were combined into 21 distinct assessment areas based on functional similarities for the pre-project ORWAP wetland functions and values assessments. For the predicted post-mitigation ORWAP wetland functions and values assessments, the remaining, enhanced, and created wetlands were combined into 17 distinct assessment areas.

Based on the results of the functions and values assessments performed for the existing wetlands proposed to be impacted and the proposed wetland mitigation areas, the Plan was determined to

provide adequate replacement for the wetland functions and values that would be lost as a result of the project. The mitigation wetlands match or exceed all the highest-rated grouped functions (i.e., Hydrologic Function, Water Quality Support, Fish Habitat, Aquatic Habitat, and Ecosystem Support) and their associated values. For the 20 individual ORWAP assessment outputs (i.e., functions, values, sensitivity, ecological condition, and stressors) of the impacted wetlands, the mitigation wetlands match or exceed most. The Plan is expected to result in an overall lift in wetland functions with the post-construction conditions. A detailed account of the wetland assessment results and functions and values replacement determination is provided in Section 5.

Functions and values of streams were assessed using the Oregon Stream Function Assessment Method (SFAM), a standardized protocol developed by DSL, USACE Portland District, Region 10 of the U.S. Environmental Protection Agency, and the Willamette Partnership. SFAM is part of a stream mitigation policy framework to guide compliance with the Federal Compensatory Mitigation Rule and the Oregon Removal-Fill Law (Nadeau et al. 2018a, 2018b). The supporting website is provided by Oregon Explorer SFAM Map Viewer (Oregon Explorer 2020). SFAM is applicable to wadable streams of any type anywhere in Oregon and was developed for impact assessments and mitigation needs determination. SFAM divides stream functions into four categories—hydrologic, geomorphic, biological, and water quality functions—with a suite of 11 specific stream functions included under these categories (Nadeau et al. 2018a). Each stream function is assigned one or more of 17 stream measures of function and 16 stream measures of value, which are metrics that allow a quantitative or qualitative assessment of specific attributes that may indicate the extent to which a particular function is active (Nadeau et al. 2018b).

Four intermittent streams (Intermittent Stream B, Tributary to Intermittent Stream B, Intermittent Stream C, and Intermittent Stream D) totaling 0.06 acre will also be impacted by the project. Functions and values lost from impacting these streams would be mitigated by the creation of Perennial Stream MS-1, which would provide approximately 1.12 acres of stream. Under post-construction conditions, Perennial Stream MS-1 is predicted to perform at similar levels or better compared to pre-project conditions for all functional groups of Intermittent Stream B, Tributary to Intermittent Stream B, Intermittent Stream D, and Perennial Stream 1-A. The created stream would provide an outlet for the created wetland areas (Wetland M-1) along the stream channel, traveling approximately 5,222 feet to its connection with the remaining portions of Wetland M and Intermittent Stream B in the southeastern area of the project site that is outside of the proposed mining site. The streambed would likely consist of exposed bedrock with areas of fines and gravels, similar to the conditions of the impacted streams, and meander to reduce velocities, erosion, and sedimentation.

Three intermittent stream assessment areas (Intermittent Stream B, Tributary to Intermittent Stream B, and Intermittent Stream D) under pre-project (i.e., existing) conditions were assessed using SFAM.

Although not proposed to be impacted and located upslope from mitigation activities, Perennial Stream 1-A was also assessed to determine its existing functions and values for comparison to the created perennial stream channel (Perennial Stream MS-1). Ephemeral streams identified in the JPA were not included in this analysis because DSL found them to be non-jurisdictional; however, if USACE takes jurisdiction of these streams, the mitigation proposed in this Plan provides adequate compensation for impacts to these streams. Because Intermittent Stream C is contained entirely within the boundaries of Wetland QQ, it was not assessed under the SFAM method and instead was assessed under the ORWAP method as part of Wetland QQ. The Plan is expected to result in an overall lift in stream functions with the post-construction conditions. A detailed account of the stream assessment results and functions and values replacement determination is provided in Section 5.

2 Compensatory Mitigation Plan Information

Table 7 provides information about the proposed project impact site and mitigation areas.

Table 7
Proposed Project Site Information

Category	Site Information
Applicant Information	Knife River Corporation—Northwest 32260 Old Highway 34 Tangent, Oregon 97389 Phone: (541) 918-5142 Attention: Jeff Steyaert
Site Owner Information	Weyerhaeuser NR Company 220 Occidental Avenue South Seattle, Washington 98104 Phone: (503) 479-2309 Attention: Mary Castle
Project Identification	Watters Quarry Phase II Project
Impact Site Location	The Watters Quarry Phase II project is located at 60371 Columbia River Highway, St. Helens, Oregon, 97051. The impact site is located on three parcels (Tax Lots 51W330000300, 51W330000400, and 51W320001600) in unincorporated Columbia County, Oregon, just north the City of St. Helens. The approximate center of the impact site is latitude 45.871449° north and longitude 122.821305° west. The project lies in Township 5 North, Range 1 West, Sections 32 and 33 of the Willamette Base and Meridian. The impact site spans two hydrologic unit codes (HUCs): HUC 170900120303 (Milton Creek) and HUC 170800030401 (Deer Island Slough-Frontal Columbia River).
Mitigation Area Location	The Watters Quarry mitigation areas are located in the northern, western, and southern portions of the project site at 60371 Columbia River Highway, St. Helens, Oregon, 97051. The areas where mitigation is proposed are located on four parcels (Tax Lots 51W32DD00100, 51W330000300, 51W330000400, and 51W320001600) in unincorporated Columbia County, Oregon. The approximate center of where the mitigation areas are located is latitude 45.87115° north and longitude 122.825663° west. The mitigation areas lie in Township 5 North, Range 1 West, Sections 32 and 33 of the Willamette Base and Meridian. The mitigation areas span two HUCs: HUC 170900120303 (Milton Creek) and HUC 170800030401 (Deer Island Slough-Frontal Columbia River).
Wetland Delineation	A wetland delineation was performed for the project site by Pacific Habitat Services in 2019. An additional wetland delineation was performed by Anchor QEA, LLC, and submitted to DSL in 2021. DSL provided concurrence on the delineation report on April 30, 2021.

3 Compensatory Mitigation Plan Principal Objectives

3.1 Functions and Values Replacement

The functions and values lost from wetlands at the impact site will be replaced by creating and enhancing wetlands that will meet or exceed existing functions and values as part of the Compensatory Mitigation Plan. Existing wetlands on the project site not proposed to be impacted will also be protected in perpetuity as part of the mitigation plan. The project will create PFO, PSS, and PEM wetland complexes and wet prairie wetlands within two of the three impacted main drainage basins, replacing the physical, chemical, and biological functions lost at the impact site. Grading of the mitigation areas will intercept and harness wetland hydrology to support a high diversity of native wetland plant species. The mitigation areas are adjacent to a network of existing upland and wetland forested, scrub-shrub, and herbaceous habitats in the north, west, and southern portions of the project site. The Plan would provide habitat improvements conducive to promoting habitat connectivity with these existing habitats. A summary of losses and gains of functions and values is provided in Section 1.5, and a detailed account of the wetland and stream assessment results and functions and values replacement determination is provided in Section 5.

3.2 Self-Sustaining or Minimum Maintenance Needs

Grading in the mitigation areas will intercept and capture existing hydrology to create self-sustaining wetland ecosystems. The mitigation areas will also use existing soils cleared of invasive, non-native species from the impact area to sustain a high biodiversity of native wetland plants identified in the impact area. Once grading is complete, minimum maintenance will include mitigation area preparation and a multiyear native plant establishment strategy. Control of non-native vegetation will occur, as needed, throughout the native plant establishment period to allow for successful growth and colonization of reproducing annual, biennial, and perennial native plant species.

3.3 Siting Considerations

The mitigation will provide in-kind replacement of the impacted wetlands and will include a combination of wetland habitats representative of impacted wetlands. Wetlands within the impact site are in the Slope, Depressional, and Depressional Outflow hydrogeomorphic (HGM) classes (Adamus 2001) and created wetlands will be the same classes. To replace wetland habitat loss at the impact site, the Plan will include creation of wet prairie wetlands and PFO, PSS, and PEM wetland complexes. Created wetlands identified as wet prairie will meet the definition of the Wet Rock Outcrop ARSC under OAR 141-085-510(3).

Most of the proposed created mitigation areas are underlain with high-quality basalt bedrock, providing a natural hardpan similar to existing conditions at the impact site. Piezometers have been installed in the impact site and in and near the mitigation areas to measure depth to groundwater

and determine flow patterns and general subsurface water accumulation areas (Appendix A, Figures A-1 through A-36) through the project site. Flow patterns that were derived from this information are shown in Figure 4. As shown in Figure 4, most of the project site is within the Central Basin and presently drains to the south through a series of wetlands, three small intermittent streams, and shallow subsurface flow across bedrock, ultimately cascading down the bluff and discharging to the Columbia River through off-site culverts and underground pipes. The Eastern Basin within the mine footprint also conveys flows over the bluff and off site to the Columbia River. No surface water connection exists between the Central and Eastern Basins and the Columbia River because the water is captured in storm drains and culverts after exiting the project site. The western portion of the project site, primarily the Western Basin, which is outside of the impact area, drains west and south and some of that flow ultimately enters Milton Creek, a tributary to the Multnomah Channel. Portions of that flow are also retained in depressional areas, such as existing Wetland C, and that hydrology eventually evaporates or flows subsurface. Similar to the existing wetlands on the site, some of that rerouted upslope hydrology would be retained in the mitigation areas and eventually evaporate or flow subsurface, but during high precipitation events, some of that water would overflow downslope and eventually into Milton Creek. Hydrology to all three of these basins will be maintained either by the mitigation design for the Western and Central Basins or the mine plan for the Eastern Basin. The majority of the Eastern Basin on the project site is within the mine footprint and fed by direct precipitation. Its hydrology will be captured by the mine, treated, and discharged near its current discharge points. The flow of the Western and Central Basins was used to aid in the final design of the Plan, which is discussed as two parts: The Central Basin (Section 6.2.1) and the Western Basin (Section 6.2.2). The Western Basin drains to Milton Creek and the mitigation portions of that area are primarily compensation for the palustrine forested impacts that occur in the Eastern Basin. The Central Basin flows to the Columbia River and the mitigation portions of that area are compensation for the intermittent streams, Depressional and Depressional Outflow palustrine emergent wetlands, and Slope, Depressional, and Depressional Outflow palustrine forested and emergent wetlands found in the Central and Eastern Basins.

Slope/Depressional Outflow PFO/PSS/PEM wetlands (Wetland M-1) and a Depressional PFO/PSS/PEM wetland (Wetland M-2) will be created in the Central Basin, and a large Slope/Depressional PFO/PSS/PEM wetland (Wetland M-3) will be created in the Western Basin to compensate for impacts to palustrine forested and emergent, Slope, Depressional, and Depressional Outflow habitats. Depressional wet prairie wetlands will be created in the Central and Eastern Basins (Wetlands M-4, M-5, M-6, M-7, M-8, M-9, and M-10) by capturing direct precipitation and ponding it in these areas. These wetlands will mitigate for the ARSC wetland impacts.

In the Central Basin, Perennial Stream 1-A presently conveys water through Wetland A then flows subsurface on shallow bedrock and via overland flow towards the southeast into the proposed mining area and into portions of Wetland M where it eventually flows into Intermittent Stream B

(Figure 6). Water from the portion of Wetland B in the Central Basin also flows subsurface on shallow bedrock to Wetland M. The Plan in the Central Basin will capture the flow that currently flows out of Perennial Stream 1-A, Wetland A, and portions of Wetland B and into the upper portion of Wetland M. The design will redirect that water into the created Perennial Stream MS-1 channel, which will meander around the mining area through a forested, scrub-shrub, emergent wetland complex, and then reconnect to the existing channel (Intermittent Stream B) in the lower portion of Wetland M that is located outside of the mining area. Where needed, an elevated berm would be constructed in uplands between the mitigation areas and the mining area to prevent the loss of wetland hydrology into the mining area. Similarly, an elevated berm would be constructed in uplands between the mitigation areas and the existing unimpacted wetlands, as needed. Site grading for the created stream channel and fringe wetland complex is designed to sustain hydrologic conditions similar to the impacted portions of Wetland M along with establishing similar wetland vegetation. Also similar to existing conditions, the lower reach of Perennial Stream MS-1 may not flow during summer months. Mitigation areas in the Central Basin are located adjacent to the northern, western, and southern limits of the proposed quarry, in areas degraded by past logging and agricultural practices.

In the Western Basin, surface and subsurface water flows from the hillside to the north, down a small ridge, and into portions of Wetlands B and TT, Ephemeral Stream B, and Wetland C (Figure 6). During high water periods, this flow discharges through a perched pipe located approximately 5 feet above the ground surface elevation at the southwest boundary of Wetland C. This pipe lies in a fill embankment constructed as part of a residential development to the west of the project site. The embankment and perched pipe serve as control structures to retain water in Wetland C and the perched pipe receives discharge from Wetland C during high-water periods. Some water that currently flows into Wetland C and the perched pipe will be captured and allowed to spread out into the mitigation area adjacent to Wetland C by grading outside of and around the wetland. Wetland C is not proposed to be impacted. There is adequate water in this area to provide sufficient hydrology to the created wetlands without impacting Wetland C.

Once grading to support the Plan is complete, the Western Basin wetlands will be located in a large, broad lowland surrounded by slopes to the north, west, and south. This will create a landscape that funnels precipitation and runoff into the created mitigation areas. Infiltration will be impeded by the natural underlying bedrock formations and, if needed, placement of clay or similar materials will prevent infiltration where needed, causing water to move slowly through the wetlands to provide self-sustaining hydrology for the wetland mitigation design. Hydrology in the existing drainage basins would be maintained, with the western portion of the project site draining either toward the perched pipe or downslope to the south, with some flow ultimately discharging to Milton Creek.

The Central Basin would discharge through a created stream (Perennial Stream MS-1) that captures subsurface and surface hydrology currently flowing across the proposed quarry area and through Wetland M and will convey that flow around the quarry, through a fringe wetland complex, and into the lower portion of Wetland M remaining on the project site. The intent of this channel is to create perennial stream functions to improve upon the existing intermittent stream functions within portions of Wetland M, and maintain hydrology within the basin by discharging at the current location of Intermittent Stream B.

No underground utilities are known to exist, and no overhead utilities are present on the project site. There are no identified limitations or constraints that would affect mitigation plan development, functionality, or sustainability at the proposed location.

3.4 Minimize Temporal Loss

To minimize temporal loss of wetland functions, grading and preparation of the mitigation areas will occur before most wetland impacts occur, and successful creation of ARSC wetlands will be demonstrated before any impacts to ARSC wetlands. This will allow hydrology to be assessed in the mitigation areas to ensure adequate hydrology is present before direct impacts to most existing wetlands occur.

DSL's Aquatic Resources Mitigation Framework accounts for temporal loss of wetland functions through an increased factor of the required mitigation credit ratio. The quarry will impact deciduous forested and emergent wetlands with the additional temporal loss of functions due to upland soils in the mitigation areas, which results in a credit increase factor of 50%. This credit increase factor has been applied to the proposed creation mitigation credit accounting methodology and is reflected in the required mitigation ratios.

4 Existing Site Conditions

4.1 Existing Wetland Habitat

Pacific Habitat Services, Inc., completed a wetland delineation for the project site in 2019, and Anchor QEA, LLC, performed an additional wetland delineation in 2021 (Figure 6). The delineations identified a total of 18.78 acres of wetlands on the project site. Within the proposed quarry area, the delineation identified a total of 0.39 acre of PEM wetlands, 4.09 acres of PFO wetlands, 5.66 acres of PFO/PEM wetlands, and 0.06 acre of intermittent streams. Approximately 0.35 acre of the wetlands in the proposed quarry area is classified as Wet Prairie or Wet Rock Outcrop ARSC under OAR 141-085-510(3). The proposed quarry area includes 1.10 acres of Slope wetlands, 0.78 acre of Depressional wetlands, and 8.26 acres of Depressional Outflow wetlands. Outside of the proposed quarry area, the delineation identified a total of 0.26 acre of PEM wetland, 0.04 acre of PSS wetland, 6.83 acres of PFO wetland, 1.16 acres of PFO/PEM wetland, and 0.26 acre of ARSC wetland. Of these wetland areas, 5.99 acres are Slope wetlands, 1.02 acres are Depressional wetlands, and 0.12 acre is Depressional Outflow wetlands.

The delineation also identified a total of 0.079 acre of perennial, intermittent, and ephemeral streams on the project site. Within the proposed quarry area or immediately downslope, the delineation identified four intermittent streams (0.06-acre total). All of these streams drain toward the Columbia River but have no surface connection to other waters. Outside of the proposed quarry area, the delineation identified 0.019 acre of perennial and ephemeral streams. Although the identified perennial stream (0.009 acre) has no surface connection to other waters, its hydrology flows through a wetland complex that eventually drains toward the Columbia River.

4.2 Existing Upland Habitat

Upland habitats include forested, shrub, and non-woody habitats characterized as Grassland, Grassland/Prairie, Mixed Forest, Mixed Woodland, Mixed Woodland/Grassland, Shrub, and Shrub/Grassland (Figure 8). The upland habitats are further described in the following sections.

4.2.1 Mixed Forest

The mixed forest habitat is in the western portion of the project site and is dominated by Douglas fir (*Pseudotsuga menziesii*), Western red cedar (*Thuja plicata*), big leaf maple (*Acer macrophyllum*), and Oregon ash (*Fraxinus latifolia*) in the canopy with a shrub layer of vine maple (*Acer circinatum*), Oregon grape (*Mahonia aquifolium*), beaked hazelnut (*Corylus cornuta*), and some red alder (*Alnus rubra*). Emergent vegetation includes Cooley's hedge nettle (*Stachys chamissionis* var. *cooleyae*), Pacific trillium (*Trillium ovatum*), Pacific starflower (*Lysimachia latifolia*), and Oregon anemone (*Anemonoides oregana*), among others. Prior to logging portions of the project site in 2015 (Figure 9), the majority of the site was forested with a mix of deciduous and coniferous canopy and

this habitat is likely representative of much of the site, prior to it being selectively logged in 2015. The site likely provides habitat for most species common to Oregon mixed forests, including a variety of mammals (e.g., deer, elk, racoon, squirrels) and birds (e.g., Steller's jay, chickadee, ruffed grouse, varied thrush). The mixed forest provides excellent habitat for woodland animals and is performing at a high level based on the minimal invasive and non-native species present and typical vegetative composition for this habitat.

4.2.2 *Mixed Woodland*

The mixed woodland habitat has at least a 30-percent tree canopy and is dominated by Oregon white oak (*Quercus garryana*) in the overstory with a few big leaf maples and Douglas fir. When a shrub layer is present, it consists primarily of Himalayan blackberry (*Rubus armeniacus*) and poison oak (*Toxicodendron pubescens*) with lesser amounts of beaked hazelnut, ocean spray (*Holodiscus discolor*), holly (*Ilex* sp.), Oregon grape, Indian plum (*Oemleria cerasiformis*), scotch broom (*Cytisus scoparius*), and salal (*Gaultheria shallon*). The understory is similar to the mixed forest understory with some fescue (*Festuca* spp.), small flower lupine (*Lupinus polycarpus*) and other grasses and forbs. This portion of the site was also not logged in 2015 and likely representative of the upland forested areas with little coniferous component prior to logging.

This habitat is also performing at a higher level due to the minimal invasive species present and high value Oregon oak component, which provides acorns and an overall habitat that is less common in the area west of the Cascade Mountain range.

4.2.3 *Mixed Woodland/Grassland*

The mixed woodland/grassland habitat was created in 2015 when the site was selectively logged to remove the more marketable trees (e.g., Douglas fir, large oaks) leaving the smaller oaks and opening up the understory. Prior to the site being logged, most of the mitigation site was either mixed forest or mixed woodland habitat with a dense canopy and little open area other than the southeast portion that includes grassland/prairie habitat (Figure 9). Since being logged, this habitat is composed of scattered Oregon oaks in the tree layer that provide 30% or less total canopy cover. The understory is open and includes Himalayan blackberry, poison oak, and scotch broom in the shrub layer and grasses including red fescue (*Festuca rubra*), orchard grass (*Dactylis glomerata*), sweet vernal grass (*Anthoxanthum odoratum*), bentgrasses (*Agrostis* spp.), and bluegrasses (*Poa* spp.) with a forb component including western yarrow (*Achillea millefolium*), small flower lupine, hairy cat's ear (*Hypochaeris radicata*), English plantain (*Plantago lanceolata*), and dandelion (*Taraxacum* spp.) in the herbaceous layer.

These ecosystems are less common west of the Cascade Mountain range and provide habitat for mammal species similar to those found in the mixed woodland with additional bird species such as

western bluebirds, flycatchers, nuthatches, California quail, western meadowlark, and various species of butterflies.

The mixed woodland/grassland and grassland habitats are relatively new to this site and have a large component of non-native species in the shrub layer, primarily Himalayan blackberry and scotch broom. The presence of these non-native shrub species lowers the habitat value of this habitat and prevents the establishment of the open, grassland component.

If left alone, the mixed woodland/grassland habitat would likely progress toward a mixed forested and woodland habitat and provide better habitat for forested species.

4.2.4 Shrub and Shrub/Grassland

The shrub and shrub/grassland habitats are composed of similar species as the mixed woodland/grassland habitat without any oaks, or other trees, present. It is dominated by Himalayan blackberry and scotch broom with western yarrow, small flower lupine, hairy cat's ear, English plantain, and dandelion in the herbaceous layer. The shrub habitat is densely populated with blackberry and scotch broom with little herbaceous component.

These habitats provide minimal value to wildlife being primarily composed of invasive blackberry and scotch broom. Himalayan blackberry does provide cover for small mammals and the fruit is eaten by a variety of mammals and birds. However, it is an invasive species providing habitat for a small number of common wildlife species and crowds out native species.

4.2.5 Grassland

The grassland habitat is void of shrubs and trees and is dominated by sweet vernal grass, bentgrasses, bluegrasses, and fescue grasses with a forb component including western yarrow, small flower lupine, hairy cat's ear, English plantain, and dandelion. Himalayan blackberry and scotch broom are sparsely present in a shrub layer; however, they comprise less than 10 percent of aerial cover in this habitat.

This habitat is currently performing at a moderate level due to the presence of many non-native grasses and forbs. The grassland habitat is also relatively new to the site and provides habitat for species that prefer open areas including bluebirds, flycatcher, western meadowlarks, and many butterfly species. This habitat is also less common west of the Cascades and would likely progress toward a mixed woodland/grassland habitat if left alone.

4.2.6 Grassland/Prairie

Grassland/prairie habitat is like the grassland habitat however it also includes camas (*Camassia* spp.), Oregon saxifrage (*Saxifraga oregana*), shortspur seablush (*Valeriana congesta*), spring gold

(*Lomatium utriculatum*), and cinquefoil (*Potentilla* spp.) in the forb layer with less orchard grass and fescue. This habitat was present prior to the logging in 2015 and has the least non-native invasive species present in the herbaceous layer. This habitat provides habitat for many species of wildlife that use open habitats including the mammals, birds, and butterflies previously identified.

4.2.7 Mitigation Area Upland Habitat

Much of the upland area in the proposed mitigation areas consists of mixed woodland/grassland and grassland. The mitigation areas will avoid as many larger oaks as possible and has been designed to avoid oak stands and existing wetland areas and are placed primarily in grassland areas; however, grading the stream channel and establishing the topography needed to route the stream and establish wetland hydrology will require the removal of several oaks in the area.

The remaining upland area surrounding the mitigation areas (i.e., buffer) will be managed to remove invasive scotch broom and Himalayan blackberry and promote maintaining the mixed woodland/grassland habitat created by the 2015 logging. This habitat is viewed as more valuable, based on comments made by Oregon Department of Fish & Wildlife personnel while in the field, and could be improved by removing the non-native shrub component and promoting native herbaceous species. This management would maintain the open understory that currently exists and blend with the grassland prairie habitat on the eastern portion of the mitigation site.

4.3 Impact Site

The impact site is located on a large bluff west and outside of the Columbia River floodplain. The western portion of the impact site was selectively logged sometime between April 2015 and July 2016, according to Google Earth Historic Imagery. The existing quarry is located north of the impact site, and lands farther north and northwest are dedicated to commercial timber, agriculture, and ranching mixed with rural residences. Lands to the west, south, and east are primarily residential developments mixed with commercial and industrial businesses.

One soil map unit is present at the impact site, 45—Rock outcrop-Xerumbrepts complex, undulating (Natural Resources Conservation Services [NRCS] 2020). This mapping unit is nonhydric (0%), has variable permeability, slow to medium runoff, and a slight to moderate hazard of erosion. Rock outcrops are exposed areas of basalt, and Xerumbrepts soils are shallow and well drained. The surface layer overlaying shallow bedrock ranges from loam, silt loam, and gravelly loam to cobbly loam, with depth to bedrock of 10 to 20 inches. Hydrology is primarily provided by direct precipitation and runoff.

Vegetation present in emergent wetlands is dominated by small camas (*Camassia quamash*), seep monkeyflower (*Mimulus guttatus*), popcorn flower (*Plagiobothrys* spp.), creeping buttercup

(*Ranunculus repens*), poverty rush (*Juncus tenuis*), common velvet grass (*Holcus lanatus*), sweet vernal grass, reed canary grass (*Phalaris arundinacea*), and various rushes and grasses.

Vegetation present in forested and scrub-shrub wetlands is dominated by Oregon ash, balsam poplar (*Populus balsamifera*), Pacific ninebark (*Physocarpus capitatus*), Douglas' spirea (*Spiraea douglasii*), twinberry honeysuckle (*Lonicera involucrata*), common snowberry (*Symphoricarpos albus*), roses (*Rosa* spp.), trailing blackberry (*Rubus ursinus*), and Himalayan blackberry. Herbs present in forested and scrub-shrub wetlands are predominantly small camas, fringed willowherb (*Epilobium ciliatum*), two-leaf false Solomon's-seal (*Maianthemum dilatatum*), buttercup (*Ranunculus* spp.), slough sedge (*Carex obnupta*), colonial bentgrass (*Agrostis capillaris*), tall fescue (*Schedonorus arundinaceus*), and reed canarygrass.

4.4 Mitigation Areas and Remaining Wetlands and Streams

The mitigation areas and remaining wetlands and streams are located northwest, west, and south of the proposed impact site. Outside of the impact site, a total of 7.13 acres of wetlands will remain on the project site in perpetuity, including 6.83 acres of PFO wetlands, 0.04 acre of PSS wetlands, and 0.26 acre of PEM wetlands, as well as 0.009 acre of perennial stream and 0.01 acre of ephemeral stream will remain. Some of these areas have also been selectively logged between 2015 and 2016. Adjacent land uses are the same as those identified for the impact site. In the Central Basin, one soil unit is mapped, 45—Rock outcrop-Xerumbrepts complex, undulating (NRCS 2020). In the Western Basin, mapped soils include map unit 45, 6D—Bacona silt loam with 3% to 30% slopes, and 10C—Cascade silt loam with 8% to 15% slopes (NRCS 2020).

The soils in the mitigation areas are all generally nonhydic silt loams. Map unit 10C has moderate permeability; however, permeability is slow below 24 inches. Map unit 6D is deeper and better drained than the other soil map units but is located in areas mostly outside of the proposed wetland creation areas. The mitigation is designed to excavate through these soils and into the underlying basalt. The basalt, with impermeable soil amendments (as needed), will act as an impermeable layer to hold water near the surface. The impermeable layer will be overlaid with upland soils stockpiled during mitigation area excavation or transported directly from upland areas in the mining area. Hydrology is primarily provided by runoff from perennial and ephemeral streams, direct precipitation, overland flow, and groundwater. The Central Basin and Perennial Stream 1-A capture runoff from the slopes to the north and northwest and the Western Basin and Ephemeral Stream B capture runoff from the slopes to the north and west.

Vegetation present in the remaining emergent wetlands is dominated by small camas, creeping buttercup, sweet vernal grass, reed canarygrass, rushes, and other grasses. Vegetation present in the remaining forested and scrub-shrub wetlands is dominated by western red cedar, Oregon ash, Oregon white oak, willows (*Salix* spp.), common snowberry, and Himalayan blackberry. Herbaceous

species dominant in these forested and scrub-shrub wetlands include hedgenettle (*Stachys* spp.), soft rush (*Juncus effusus*), taper-fruit short-scale sedge (*Carex leptopoda*), common velvet grass, and reed canarygrass.

4.5 Factors Leading to Degraded Condition

Factors contributing to degraded condition of some portions of the delineated wetlands outside of the mining area include past logging activities in wetlands and adjacent uplands, resulting in vegetation removal, soil compaction, and the presence of invasive species.

The most recent logging occurred within the past decade. Logging was selective, primarily focused on the harvest of mature Douglas fir (*Pseudotsuga menziesii*) trees, whereas some Oregon white oaks were retained. The removal of mature forest canopy has facilitated the establishment of non-native and invasive species in and around the mitigation and remaining wetland areas, including scotch broom, Himalayan blackberry, common mullein (*Verbascum thapsus*), common velvet grass, Canada thistle (*Cirsium arvense*), reed canarygrass, tall fescue, field meadow-foxtail (*Alopecurus pratensis*), and orchard grass (*Dactylis glomerata*).

Wetlands A, B, C, F, G, and TT will be enhanced with implementation of this Plan; however, this aspect of the mitigation is to increase the success of the created areas and is not included in the mitigation acreage. The nonforested portions of Wetlands A, B, C, F, G, and TT have become dominated by reed canarygrass. The creeping rhizomes of reed canarygrass can form a thick sod layer that excludes other plants from establishing. This leads to dense monocultures that reduce habitat diversity and complexity. Other non-native species present in these wetlands include common velvet grass, tall fescue, sweet vernal grass, Himalayan blackberry, and English hawthorn (*Crataegus monogyna*).

4.6 Means for Reversal of Degradation

The primary aspect of the mitigation and the only aspect included in the mitigation ratios will be creation of wetlands in upland areas; however, some enhancement will occur in Wetlands A, B, C, F, G, and TT to decrease the seed source of invasive and non-native species in wetlands adjacent to the wetland creation areas. Degradation in these wetlands will be reversed, minimized, or controlled to ensure self-sustaining success by removing invasive and non-native species from these wetlands and planting native species. Degraded areas in Wetlands A, B, C, and TT will be enhanced by removing reed canarygrass from infested areas and replanting with native trees and shrubs. Reed canarygrass and other non-native species will be removed from Wetlands F and G and replanted with native herbaceous species common in wet prairie habitats. This aspect of the Plan is intended to decrease non-native seed sources during the initial years of the wetland creation areas.

5 Functions and Values Assessment

Wetlands proposed for impact and mitigation were evaluated using ORWAP to inform the mitigation design to replace or improve wetland functions overall. Streams proposed for impact and mitigation were evaluated using SFAM to ensure adequate replacement of functions.

This section of the Plan explains the methods used to conduct the functions and values assessment and provides the results of the assessment. Completed data forms and figures supporting the assessment are provided in Appendix B. ORWAP and SFAM summary tables for pre- and post-construction are provided in Appendix C and summarized in Section 5.2.

5.1 Functions and Values Assessment Methods

As mentioned in Section 1.5, ORWAP (Adamus et al. 2016a, 2016b) was used to assess the functions and values of the existing wetlands and the proposed remaining, enhanced, and compensatory mitigation wetlands. ORWAP can be used to assess up to 16 of the most common functions and 15 of the most common values that are attributed to Oregon wetlands (Adamus et al. 2016a). However, for the purposes of permitting-related work, DSL requires that results of an ORWAP functions and values assessment is reported at the group level, which represents aggregated functions and values (i.e., Hydrologic Function, Water Quality Support, Fish Habitat, Aquatic Habitat, and Ecosystem Support). Each group is represented by the highest-rated function with the highest-rated associated value rating. These groups and the functions and values that they represent are shown in Table 8 along with the additional ORWAP assessment outputs for wetland sensitivity, wetland ecological condition, and wetland stressors.

With the exception of the Organic Nutrient Export function and five other scored attributes (Carbon Sequestration, Public Use and Recognition, Wetland Sensitivity, Wetland Ecological Condition, and Wetland Stressors), ORWAP generates both a functional effectiveness (i.e., function) score and a relative value of function (i.e., value) score for each of these groups. For the Organic Nutrient Export function and Carbon Sequestration attribute, only a function score is provided by the model; for the Public Use and Recognition, only value scores are provided. The ORWAP model also provides scores for the Wetland Sensitivity, Wetland Ecological Condition, and Wetland Stressors attributes. Wetland Sensitivity refers to the resistance and resilience of a wetland to human and natural stressors; Wetland Ecological Condition refers to the integrity or health of a wetland based primarily on its vegetation and is often referred to as “naturalness;” and Wetland Stressors refers to the degree to which the wetland has recently been altered by or exposed to risk from human and natural factors (Adamus et al. 2016a).

To evaluate wetland functions and values, background information was first collected for each wetland and its contributing area. This assessment included collecting surrounding land use and

historical land cover and answering the desktop portions of the ORWAP questions. Questions were answered using published databases available online, existing map resources, and aerial photography. An Oregon Explorer ORWAP report was also generated and is provided in Appendix B.

As mentioned in Section 1.5, SFAM was used to assess the functions and values of the existing and proposed streams. As shown in Table 9, SFAM divides stream functions into four categories—hydrologic, geomorphic, biological, and water quality functions—with a suite of 11 specific stream functions included under these categories. Each stream function is assigned one or more of 17 stream measures of functions and 16 stream measures of values, which are metrics that allow a quantitative or qualitative assessment of specific attributes that may indicate the extent to which a particular function is active. Streams are intended to be assessed by evaluating the degree to which they perform or provide these metrics.

Project site visits were performed by Anchor QEA staff in June 2020 and February and March 2021 to assess functions and values of wetlands and streams on the project site. In addition, information from Pacific Habitat Services' project site visits in February, March, and April 2018; April, May, June, and July 2019; and March 2020 were used to inform the assessment. All assessment areas were evaluated while filling out the data forms. These project site visits covered both wet and dry times of the year, as recommended by ORWAP.

Table 8
Wetland Functions and Values Assessed by the Oregon Rapid Wetland Assessment Protocol (ORWAP)

Primary Groups	Aggregated Functions Within Each Group	Function	Value
Hydrologic Function	Water Storage and Delay	X	X
Water Quality Support	Sediment Retention and Stabilization	X	X
	Phosphorus Retention	X	X
	Nitrate Removal and Retention	X	X
Fish Habitat	Anadromous Fish Habitat Support	X	X
	Resident Fish Habitat Support	X	X
Aquatic Habitat	Amphibian and Reptile Habitat	X	X
	Waterbird Nesting Habitat	X	X
	Waterbird Feeding Habitat	X	X
Ecosystem Support	Aquatic Invertebrate Habitat	X	X
	Songbird, Raptor, and Mammal Habitat	X	X
	Water Cooling	X	X
	Native Plant Diversity	X	X
	Pollinator Habitat	X	X
	Organic Nutrient Export	X	N/A
Other Attributes			
Carbon Sequestration		X	N/A
Public Use and Recognition		N/A	X
Wetland Sensitivity		N/A	N/A
Wetland Ecological Condition		N/A	N/A
Wetland Stressors		N/A	N/A

Note:
N/A: not applicable

Table 9
Stream Functions and Values Assessed by the Oregon Stream Function Assessment Method (SFAM)

Functional Group	Specific Functions	Definition and Services and Values Provided	Stream Measures of Function
Hydrologic Functions	Surface Water Storage	Temporary storage of surface water in relatively static state, generally during high flow, as in floodplain inundation, backwater channels, and wetland depressions. Provides regulating discharge; replenishes soil moisture; and provides pathways for fish and invertebrate movement, low-velocity habitat and refuge, and contact time for biogeochemical processes.	<ul style="list-style-type: none"> • Overbank Flow • Incision • Floodplain Exclusion • Channel Bed Variability • Wood • Side Channels
	Sub/Surface Transfer	Transfer of water between surface and subsurface environments, often through the hyporheic zone. Provides aquifer recharge, base-flow, and exchange of nutrients and chemicals through the hyporheic zone; moderates flow; and maintains soil moisture.	<ul style="list-style-type: none"> • Overbank Flow • Wetland Vegetation • Side Channels • Channel Bed Variability
	Flow Variation ¹	Daily, seasonal, and interannual variation in flow. Provides variability in stream energy driving channel dynamics; provides environmental cues for life history transitions; redistributes sediment; and provides habitat variability (temporal), sorting of sediment, and differential deposition.	<ul style="list-style-type: none"> • Channel Bed Variability • Embeddedness
Geomorphic Functions	Sediment Continuity	The balance between transport and deposition of sediment such that there is no net erosion or deposition (aggradation or degradation) within the channel. Maintains channel character and associated habitat diversity, provides sediment source and storage for riparian and aquatic habitat succession, and maintains channel equilibrium.	<ul style="list-style-type: none"> • Incision • Bank Erosion • Lateral Migration
	Substrate Mobility	Regular movement of channel bed substrate. Provides sorting of sediments, mobilizes and flushes fine sediment, and creates and maintains hydraulic diversity and habitat.	<ul style="list-style-type: none"> • Bank Armoring • Embeddedness • Channel Bed Variability
Biologic Functions	Maintain Biodiversity	Maintains the variety of species, life forms of a species, community compositions, and genetics. Biodiversity provides species and community resilience in the face of disturbance and disease, full spectrum trophic resources, and balance of resource use (through interspecies competition).	<ul style="list-style-type: none"> • Fish Passage Barriers • Channel Bed Variability • Wood • Side Channels • Invasive Vegetation • Native Woody Vegetation • Large Trees • Wetland Vegetation

Functional Group	Specific Functions	Definition and Services and Values Provided	Stream Measures of Function
Biologic Functions (continued)	Create Habitat (Aquatic/Riparian)	Creates and maintains the suite of physical, chemical, thermal, and nutritional resources necessary to sustain organisms. Habitat sustains native organisms and includes in-channel habitat, as defined largely by depth, velocity, and substrate, and riparian habitat, as defined largely by vegetative structure.	<ul style="list-style-type: none"> • Floodplain Exclusion • Wood • Embeddedness • Channel Bed Variability • Native Woody Vegetation • Large Trees • Incision • Side Channels • Fish Passage Barriers
	Sustain Trophic Structure	Production of food resources necessary to sustain all trophic levels including primary producers, consumers, prey species, and predators. Trophic structure provides basic nutritional resources for aquatic resources and regulates the diversity of species and communities.	<ul style="list-style-type: none"> • Overbank Flow • Natural Cover • Invasive Vegetation • Native Woody Vegetation • Wetland Vegetation
Chemical and Nutrient Functions	Nutrient Cycling	Transfer and storage of nutrients from environment to organisms and back to environment. Provides basic resources for primary production, regulates excess nutrients, and provides sink and source for nutrients.	<ul style="list-style-type: none"> • Overbank Flow • Channel Bed Variability • Vegetated Riparian Corridor Width • Wetland Vegetation • Natural Cover
	Chemical Regulation	Moderation of chemicals in the water. Limits the concentration of beneficial and detrimental chemicals in the water.	<ul style="list-style-type: none"> • Vegetated Riparian Corridor Width • Channel Bed Variability • Wetland Vegetation • Overbank Flow
	Thermal Regulation	Moderation of water temperature. Limits the transfer and storage of thermal energy to and from streamflow and hyporheic zone.	<ul style="list-style-type: none"> • Natural Cover

Notes:

Table adapted from Table 2.1 of Nadeau et al. (2018a) and Table 4.2 of Nadeau et al. (2018b).

1. Flow variation is also informed by the value measure Impoundments.

5.2 Functions and Values Results

Pre-project ORWAP wetland functions and values for each of the assessment areas and predicted post-mitigation creation and enhancement wetlands are provided in Tables C-1 through C-21 in Appendix C. Pre-project SFAM functions and values for each of the assessment areas and predicted post-mitigation stream functions and values are provided in Table C-22 in Appendix C.

5.3 Summary of Change at the Impact Site

Quarry operations will result in direct and potential indirect impacts to 24 wetlands totaling 11.56 acres. Most of these wetlands are less than 0.25 acre in size. As discussed in Section 1.4, these wetlands include PEM and PFO Cowardin classifications (Cowardin et al. 1979) and Depressional, Depressional Outflow, and Slope HGM classifications. A total of 0.35 acre of wet prairie and wet rock outcrop ARSC wetlands is included in this impact site. Direct and potential indirect impacts to four intermittent streams will also occur, totaling 0.06 acre.

Operation of the quarry will result in excavation of the impact site to extract rock. Impacts to the wetlands and streams at the impact site will result from the complete removal of these features, as well as a complete loss of their functions and values. Aggregate mining in the proposed quarry would require the direct excavation of approximately 10.23 acres of wetlands and 0.002 acre of intermittent stream. As a result, those wetlands and stream would be completely eliminated. Indirect impacts to 1.42 acres of wetlands and 0.06 acre of intermittent streams located outside of the proposed quarry would also occur from the alteration of hydrology. Of the 1.42 acres of potential indirect wetland impacts, 0.26 acre meets the definition of ARSC wetland. Over time, it is uncertain if those areas would function similarly to existing conditions and are therefore included in the total impacts. However, these areas of potential indirect impacts may be monitored to determine whether compensatory mitigation is required. That is, if hydrologic monitoring and a wetland delineation show that there are no indirect impacts, the required mitigation may be reduced accordingly pending approval by DSL.

The purpose of the compensatory mitigation is to replace or improve upon the loss of function and values of the impacted wetlands and streams.

5.4 Summary of Existing Functions and Values

All of the 21 wetland assessment areas are best at providing hydrologic functions and water quality support based on receiving higher scores for these functional groups, except Assessment Area 1 (Wetland A), Assessment Area 2 (Wetlands B and TT), Assessment Area 3 (Wetland C), Assessment Area 4 (Wetlands D and E), Assessment Area 7 (Wetland M), Assessment Area 8 (Wetland N), Assessment Area 9 (Wetlands L, SS, and XX), Assessment Area 11 (Wetland U), Assessment Area 18 (Wetland PP), Assessment Area 19 (Wetland YY), and Assessment Area 21 (Wetland OO), which

received more moderate to low scores for those functional groups. All assessment areas provide suitable aquatic habitat based on all receiving higher scores for that functional group. Most assessment areas are also best at providing ecosystem support, with all receiving higher scores for this group except for Assessment Area 5 (Wetlands F and G), Assessment Area 6 (Wetlands H, I, J, and K), Assessment Area 10 (Wetlands O through T, QQ, and RR), Assessment Area 19 (Wetland YY), and Assessment Area 21 (Wetland OO), which received more moderate scores. None of the assessment areas are suitable for providing fish habitat because all received lower scores for that group of functions, access is blocked, and there are no known populations of resident fish.

With respect to the values of these functional groups, the hydrologic functions and water quality support groups scored the highest for all assessment areas. The aquatic habitat group had lower to moderate value scores for all assessment areas. The ecosystem support group had lower scores for all assessment areas except for Assessment Area 7 (Wetland M), 10 (Wetlands O through T, QQ, and RR), and 18 (Wetland PP), which received higher value scores for this group of functions. For the fish habitat group, all assessment areas received low scores for the values of these functions.

For Carbon Sequestration, most assessment areas are providing this function at moderate levels, except for Assessment Area 4 (Wetlands D and E), Assessment Area 9 (Wetlands L, SS, and XX), Assessment Area 10 (Wetlands O through T, QQ, and RR), Assessment Area 11 (Wetland U), Assessment Area 18 (Wetland PP), Assessment Area 19 (Wetland YY), and Assessment Area 21 (Wetland OO), which are providing this function at lower levels. For the Wetland Sensitivity, Wetland Ecological Condition, and Wetland Stressor attributes, all assessment areas received moderate to lower scores except for Assessment Area 7 (Wetland M), Assessment Area 9 (Wetlands L, SS, and XX), and Assessment Area 10 (Wetlands O through T, QQ, and RR). These three assessment areas received a higher rating for the Wetland Sensitivity attribute due to containing the native wet prairie wetland type. Assessment Area 11 (Wetland U) and Assessment Area 19 (Wetland PP), which are also native wet prairie wetland types both had a rating proximity break of "MH" for the Sensitivity attribute, indicating a close proximity break between the moderate and higher ratings. All assessment areas received low value scores for the Public Use and Recognition function.

The detailed results of the SFAM functions and values assessments under pre-project (i.e., existing) conditions are summarized in the attached wetland and stream functions and values assessment report (Appendix B). Perennial Stream 1-A received higher scores for all functional groups except for the biologic functional group, which received a more moderate score. Value scores for Perennial Stream 1-A were higher for the hydrologic functional group, moderate for the geomorphic and biologic functional groups, and lower for the water quality functional group. Intermittent Stream B received higher scores for all functional groups and similar value scores for those functions as Perennial Stream 1-A. The Tributary to Intermittent Stream B received higher scores for the hydrologic and geomorphic functional groups and moderate scores for the biologic and water

quality functional groups. The value scores for those functions ranged from higher to lower. Intermittent Stream D received higher scores for the geomorphic and water quality functional groups and moderate scores for the hydrologic and biologic functional groups. The value scores for those functions ranged from high to moderate.

5.5 Summary of Post-Construction Compensatory Mitigation Creation

Wetland mitigation creation will result in 8.88 acres of PFO/PSS/PEM Slope/Depressional Outflow wetlands (Wetland M-1), 0.51 acres of PFO/PSS/PEM Depressional wetland (Wetland M-2) 7.63 acres of PFO/PSS/PEM Slope/Depressional wetland (Wetland M-3), and 1.30 acre of PEM Depressional wetlands (Wetlands M-4, M-5, M-6, M-7, M-8, M-9, and M-10) that will also meet the definition of ARSC. When the mitigation construction is complete, a total of 18.32 acres of wetlands will be created on the project site. Creation of Perennial Stream MS-1 will create a total of 1.12 acres of stream that is currently not present on the project site. Created wetlands and streams will provide functions and values that are currently not present in these areas and will create wetland habitats similar to those impacted by the project.

5.6 Functions and Values Replacement

Under post-construction conditions, wetland and stream mitigation is predicted to perform at similar levels or better compared to pre-project conditions for all functional groups (Appendix C). The values of those functions are also anticipated to be similar or higher. The created wetlands are designed to function and provide values for those functions at levels commensurate with pre-project conditions. Factors providing the functional lift for the created wetlands include the increased size of the wetlands, the planting of native woody species, the creation of forested and wet prairie wetlands, the provision of increased water storage and treatment, and the replacement of locally important ecological functions and services that will be permanently lost at the impact site. Tables 10 through 13 summarize the average scores for the ORWAP key outputs by HGM classification for impacted wetlands under pre-project conditions compared to created wetlands under post-project conditions. Post-project average ORWAP scores exceed, equal, or are only slightly lower (less than 2%) compared to existing conditions. Table 14 summarizes the average scores for the SFAM key outputs for impacted streams under pre-project conditions compared to the created stream under post-project conditions. Post-project average SFAM scores exceed, equal, or are only slightly lower (less than 3%) compared to existing conditions.

Table 10**Pre- and Post-Project Average ORWAP Scores for Slope and Slope/Depressional Wetlands**

Groups¹		Average ORWAP Scores		Post-Mitigation Change in Average Score
		Impacted Slope Wetlands¹	Created Slope/Depressional Wetlands²	
Hydrologic Function	Function	4.89	10.00	+5.11
	Value	7.50	7.50	0.00
Water Quality Support	Function	3.74	10.00	+6.26
	Value	6.77	6.83	+0.05
Fish Habitat	Function	0.00	0.00	0.00
	Value	0.00	0.00	0.00
Aquatic Habitat	Function	8.66	8.67	+0.01
	Value	2.08	2.09	0.00
Ecosystem Support	Function	5.68	6.75	+1.07
	Value	1.36	1.27	-0.09
Additional Attributes				
Carbon Sequestration	Function	3.71	6.25	+2.54
Public Use & Recognition	Value	1.80	3.75	+1.95
Wetland Sensitivity		0.45	2.70	+2.24
Wetland Ecological Condition		1.61	5.26	+3.65
Wetland Stressors		3.33	5.00	+1.67

Notes:

1. Impacted Slope wetlands include Wetlands D and E.
2. Created Slope/Depressional wetland includes Wetland M-3.

Table 11
Pre- and Post-Project Average ORWAP Scores for Depressional/Depressional Outflow and Slope/Depressional Wetlands

Groups ¹		Average ORWAP Scores		Post-Mitigation Change in Average Score
		Impacted Depressional/Depressional Outflow Wetlands ¹	Created Slope/Depressional/Depressional Outflow Wetlands ²	
Hydrologic Function	Function	8.37	10.00	+1.63
	Value	7.50	7.50	0.00
Water Quality Support	Function	8.05	10.00	+1.95
	Value	6.86	6.92	+0.05
Fish Habitat	Function	0.00	0.00	0.00
	Value	0.00	0.00	0.00
Aquatic Habitat	Function	8.30	8.27	-0.03
	Value	2.07	2.54	+0.47
Ecosystem Support	Function	4.98	5.62	+0.64
	Value	1.09	1.37	+0.28
Additional Attributes				
Carbon Sequestration	Function	4.61	6.29	+1.68
Public Use & Recognition	Value	1.86	3.83	+1.98
Wetland Sensitivity		1.85	2.67	+0.82
Wetland Ecological Condition		2.65	5.36	+2.71
Wetland Stressors		4.52	5.00	+0.48

Notes:

1. Impacted Depressional/Depressional Outflow wetlands include Wetlands H, I, J, K, N, AA, BB, CC, ZZ, and YY.
2. Created Slope/Depressional wetlands include Wetlands M-2 and M-3.

Table 12
Pre- and Post-Project Average ORWAP Scores for Slope/Depressional Outflow Wetlands

Groups ¹		Average ORWAP Scores		Post-Mitigation Change in Average Score
		Impacted Slope/Depressional Outflow Wetlands ¹	Created Slope/Depressional Outflow Wetland ²	
Hydrologic Function	Function	3.08	5.47	+2.38
	Value	7.50	7.50	0.00
Water Quality Support	Function	3.69	3.98	+0.29
	Value	7.16	7.40	+0.23
Fish Habitat	Function	0.00	0.00	0.00
	Value	0.00	0.00	0.00
Aquatic Habitat	Function	8.72	8.62	-0.10
	Value	2.07	2.09	+0.02
Ecosystem Support	Function	6.36	7.11	+0.75
	Value	3.06	3.00	-0.06
Additional Attributes				
Carbon Sequestration	Function	3.96	4.92	+0.96
Public Use & Recognition	Value	1.81	3.76	+1.95
Wetland Sensitivity		5.47	6.30	+0.83
Wetland Ecological Condition		3.53	5.06	+1.53
Wetland Stressors		3.33	3.33	0.00

Notes:

1. Impacted Slope/Depressional Outflow wetland includes Wetland M.
2. Created Slope/Depressional Outflow wetland includes Wetland M-1.

Table 13
Pre- and Post-Project Average ORWAP Scores for ARSC Wetlands¹

Groups ¹		Average ORWAP Scores		Post-Mitigation Change in Average Score
		Impacted ARSC Wetlands ²	Created ARSC Wetlands ³	
Hydrologic Function	Function	6.98	7.24	+0.26
	Value	7.50	7.50	0.00
Water Quality Support	Function	6.25	6.45	+0.20
	Value	6.77	7.21	+0.44
Fish Habitat	Function	0.00	0.00	0.00
	Value	0.00	0.00	0.00
Aquatic Habitat	Function	2.64	8.30	+5.66
	Value	0.37	2.07	+1.70
Ecosystem Support	Function	4.38	5.12	+0.74
	Value	2.80	2.88	+0.09
Additional Attributes				
Carbon Sequestration	Function	3.23	3.19	-0.04
Public Use & Recognition	Value	1.88	3.82	+1.94
Wetland Sensitivity		4.66	5.56	+0.90
Wetland Ecological Condition		0.72	2.99	+2.27
Wetland Stressors		4.17	4.17	0.00

Notes:

1. ARSC wetlands are classified as Flats or Depressional wetlands constrained by bedrock or hardpan with an intermittent to seasonally flooded water regime (Oregon Explorer 2023).
2. Impacted Depressional/Depressional Outflow wetlands includes Wetlands L, O through T, QQ, RR, SS, and XX.
3. Created Depressional wetlands include Wetlands M-4, M-5, M-6, M-7, M-8, M-9, and M-10.

Table 14
Pre- and Post-Project Average SFAM Scores for Streams

Groups		Average SFAM Scores		Post-Mitigation Change in Average Score
		Impacted Intermittent Streams ¹	Created Perennial Stream ²	
Hydrologic Function	Function	6.23	7.68	+1.45
	Value	8.30	8.06	-0.24
Geomorphic Function	Function	7.80	8.62	+0.82
	Value	4.22	5.38	+1.16
Biologic Function	Function	3.52	5.29	+1.77
	Value	5.54	6.75	+1.21
Water Quality Function	Function	5.20	7.14	+1.94
	Value	4.31	4.89	+0.58

Notes:

1. Impacted intermittent streams includes Intermittent Stream B, Tributary to Intermittent Stream B, Intermittent Stream C, and Intermittent Stream D.
2. Created perennial stream includes Perennial Stream MS-1.

6 Compensatory Mitigation Design Construction

This section describes the elements of mitigation design construction.

6.1 Design Considerations

Design considerations associated with the project include the following:

- Capturing surface and shallow subsurface hydrology for the Central and Western Basins to provide sufficient hydrology for mitigation wetlands and maintain existing basin water quantities, including water quantities exiting the site
- Maintaining the hydrology of the Central and Western Basins within the respective basins and directing outflow to the existing outflow locations within those basins
- Grading existing soils and utilizing the impermeable underlying basalt to create conditions that capture direct precipitation, runoff, and shallow subsurface inputs and that establish wetland hydrology
- Reusing stockpiled soils from mitigation area excavation or directly transported upland soils from the mining area as topsoil in the mitigation areas, which will be graded to provide a suitable substrate for the establishment of hydric soils for created wetlands and upland soil to support woody species in riparian areas
- Grading the channel for Perennial Stream MS-1 and adjacent wetlands prior to directing flow from Perennial Stream 1-A to ensure hydrology is flowing and ponding correctly and any potential fissures are identified and filled before adding soil and intercepting flow from Perennial Stream 1-A and Wetland M
- Capturing and directing flow from Perennial Stream 1-A into created channel of Perennial Stream MS-1 and associated created fringe Slope/Depressional Outflow PFO/PSS/PEM wetland complex (Wetland M-1) and carrying that flow back into the downstream portions of Wetland M and into Intermittent Stream B (Central Basin)
- Grading the created fringe Slope/Depressional Outflow PFO/PSS/PEM wetland complex (Wetland M-1) associated with Perennial Stream MS-1 to primarily retain surface and subsurface hydrology but to also receive seasonal overflow from the created stream channel MS-1
- Capturing and directing flow from Ephemeral Stream B and increasing the overall wetland area north of Wetland C (Western Basin) and intercepting shallow subsurface water south of Wetland C to create Wetland M-3
- Avoiding impacts to most existing high-quality forested uplands with mitigation area siting
- Creating Slope/Depressional PFO/PSS/PEM areas (Wetlands M-2 and M-3) to mitigate for Slope/Depressional/Depressional Outflow PFO wetland impacts
- Creating Depressional wet prairie habitat (Wetlands M-4, M-5, M-6, M-7, M-8, M-9, and M-10) to compensate for impacted wet prairie and wet rock outcrop ARSC wetlands

- Planting and seeding appropriate native species after grading to establish native wet prairie, scrub-shrub, and forested wetlands, similar to those areas impacted by the quarry
- Creating diverse habitat by planting native trees, shrubs, and herbs to increase available wildlife habitat, including nesting, foraging, and cover habitat
- Planting native trees and shrubs along the length of the created Perennial Stream MS-1 channel to provide sufficient overwater shade cover
- Creating depressions to increase water storage and delay function
- Creating microtopography to enhance hydrological and ecosystem functions
- Reusing logs and intact root wads salvaged from uplands in the mining area for placement into portions of Perennial Stream MS-1 to enhance water quality habitat functions
- Placement of at least 20 pieces of unanchored wood (each a minimum of 5 inches in diameter and 6 feet long) across the created stream channel in various locations to encourage habitat-forming processes
- Creation of side channels along the created stream that make up at least 25% of the length of the created channel
- Performing regular mitigation area maintenance by removing invasive species using hand pulling, flaming, shading, and spot-spraying methods

6.2 Grading Plan

The grading plan, cross sections, and TESC plan are provided in Appendix E. The primary goals for grading the mitigation design are as follows:

- Excavating existing basalt and upland soils, grading down to design elevations, and utilizing the underlying impermeable bedrock to create conditions that capture direct precipitation, runoff, and tributary inputs and establish wetland hydrology
- If necessary, filling select excavated areas with clay or similar materials, to prevent water from infiltrating fissures in the bedrock
- For areas needing impermeable material to fill fissures, the area will be graded down a few additional inches below final grade to ensure there is adequate room for the clay (or similar) layer, below either the rock channel or thin topsoil for wetland establishment
- Reusing stockpiled soils from mitigation area excavation or directly transported upland soils from the mining area as topsoil in the mitigation areas, which will be graded to provide a suitable substrate for the establishment of hydric soils
- Developing wetland hydrology in the mitigation areas through grading native wet prairie, emergent, scrub-shrub, and forested wetlands, similar to those areas impacted by the quarry
- Creating microtopography by leaving graded areas rough and uneven
- Adaptively manage the grading plan during construction to avoid as much as possible high value habitat or individual trees of high value (e.g., larger oaks)

Existing 2-foot contours of the project site are shown on the grading plan in Appendix E. Grading limits will be identified in the field, and all areas to be graded will be staked prior to construction. Erosion control measures will be installed where required to reduce the likelihood of erosion and sedimentation to adjacent existing wetlands and off-site areas. Grading equipment will access the mitigation areas using existing dirt and gravel roads that can be accessed from Liberty Hill Road, just south of the existing quarry. Staging areas will be established only in upland areas.

6.2.1 Central Basin

The grading plan is provided in Appendix E and identifies the mitigation areas in the Central Basin. These created areas will primarily mitigate impacts to streams and wetlands in the Central Basin.

6.2.1.1 Stream Wetland Complex

To initially create the northernmost portion of Perennial Stream MS-1 in the Central Basin, grading will involve excavation starting upslope from Wetland M, working upward to just before the interception of groundwater moving downslope from the lower portions of Perennial Stream 1-A and Wetlands A and B in the northern portion of the project site. No grading will occur in Perennial Stream 1-A or Wetlands A and B. Following this initial grading, direct precipitation during storm events over the bare rock (exposed at below final grade or at final grade where the stream channel is bedrock) will be monitored to determine if flows and ponding is working and to identify any potential fissures. Once that is established, clay would be brought in, if needed, to ensure correct ponding and flow. Then the final excavation would occur intercepting the flow from Perennial Stream 1-A and Wetlands A and B, including the excavation of the remaining portions of the Perennial Stream MS-1 channel. Excavation in these areas would remove topsoil and underlying basalt to create a roughly 3 horizontal to 1 vertical (3H:1V) slope to eventually intercept and capture the existing flow exiting the Perennial Stream 1-A channel, Wetland A, and Wetland B and overland flow from surrounding upland areas. Currently, this water flows subsurface along bedrock from Perennial Stream 1-A, Wetland A, and Wetland B into Wetland M; during periods of high water, this hydrology also flows overland. This combined flow will be intercepted and conveyed into the created channel for Perennial Stream MS-1, portions of which will be surrounded by a created wetland fringe and ponded wetland areas (Wetland M-1). The created stream channel will meander to the southeast between Wetland B and Wetlands F and G and then bend to the southwest around the outer boundaries of Wetland B and continue to the southwest along the southeastern boundary of Wetland B. No grading will occur in Wetlands F or G. Near the western boundary of Wetland D, the Perennial Stream MS-1 channel will bend to the south and then meander to the east through portions of the created fringe wetland complex (Wetland M-1) before flowing into Intermittent Stream B and then into the lower portions of Wetland M. Perennial Stream MS-1 will consist of exposed bedrock in places along with some gravels and fines, similar to the conditions of the impacted streams, and will have an approximately 3-foot-wide channel up to 1-foot deep with most

areas 6 inches or less in depth. The channel will be very gradual and will meander to reduce velocities, erosion, and sedimentation. Side channels will be incorporated into the design of Perennial Stream MS-1 for added habitat complexity and to spread out and provide additional hydrology during high flows for the created adjacent wetland areas (Wetland M-1) along the banks of Perennial Stream MS-1. Rock flumes consisting of 4-inch streambed cobbles, 12-inches in depth will be placed in steeper portions of the channel to slow water flow, trap sediment, and create terraces in the stream. In addition, large woody debris with a diameter of at least 5 inches and a length of at least 6 feet would be placed in the stream channel at a frequency of 20 logs per 328 feet of channel to help reduce water velocities and create more diverse aquatic habitat. The majority of the stream channel would also be flanked by overhanging native woody vegetation in the overstory and understory, as part of the mitigation planting plan.

Excavation in Perennial Stream MS-1 would lower the elevation to approximately 6 inches below the elevation of the adjacent created wetland complexes (Wetland M-1), which represents the final grade of excavation. The majority of the soil and rock removed from uplands to create mitigation areas would be reused or potentially stockpiled on site. If suitable, some of the removed rock may be processed on site and brought to market. However, the purpose of excavation in the mitigation areas is to grade down to elevations that sustain successful stream and wetland creation. Most of the material proposed to be removed in the mitigation areas consists of overburden and interflow rock volume. Interflow rock zones lie between basalt flows and may have accumulations of sedimentary deposits or strongly weathered basalt in the underlying flow. These interflow deposits tend to be silty to clayey and not marketable. Any potentially marketable material excavated from mitigation areas is anticipated to be minimal. Regardless, material removed to construct the mitigation areas must be managed. This material could be stockpiled on site, but this is not ideal as it may impact existing upland habitat.

Once excavation is complete, the exposed soil and bedrock conditions will be evaluated to determine if the surfaces are adequately directing and holding water. Flow over bedrock will also be evaluated to determine if flow is adequate and in the correct areas for both stream and wetland creation. If infiltration through the soil or fissures in the exposed bedrock is observed to a degree that stream and wetland hydrology may not be sufficient, the elevation will be lowered as needed to accommodate a 1- to 2-inch layer of clay or similar impermeable materials, which will be spread across the stream and wetland creation areas to create a confining layer of subsoil. This layer would restrict water from infiltrating through the soil and through fissures in the underlying basalt. If no fissures are identified in the created stream channel and water ponds in wetland areas naturally on the bedrock, clay will not be needed. Upland soils stockpiled from mitigation area grading or transported from the mining area will then be placed over the bedrock or clay layer. An approximately 12- to 36-inch-deep or thicker layer of stockpiled upland soils will be placed in adjacent uplands where bedrock was exposed by excavation. Following initial grading, the placed

soils will be plowed to roughen up the surface and initiate mitigation area microtopography formation. Additional grading may be needed after site hydrologic patterns are assessed.

To reduce the presence of existing non-native seed banks, mitigation area preparation may include treating the graded areas with tarps, flaming, or herbicide application. The removal of invasive species in adjacent Wetlands A, B, C, F, G, and TT will also aid in invasive species control.

All grading activities will be supervised by a qualified wetland consultant and stream design engineer. Equipment likely to be used during grading includes excavators, graders, scrapers, bulldozers, and dump trucks.

6.2.1.2 Hydraulic Modeling

Hydraulic modeling was performed to support the grading design and verify the proposed channel and wetland configurations would perform as designed. The created stream channel has been sized to be similar to the stream associated with Wetland M (Intermittent Stream B) and to adequately convey peak flows from the upper portion of the Central Basin that enters Perennial Stream 1-A (Figure 4). Surface water hydrology estimates were developed for the contributing basin above Perennial Stream 1-A to provide an understanding of flows and volumes that flow through the stream channel. Peak flows were estimated following guidance from the Columbia County Stormwater and Erosion Control Ordinance (Columbia County 2001), which provides recommended design storm precipitation rates and methodology. These data were used to calculate peak flows and runoff volumes for four events: the water quality event, 2-year event, 10-year event, and 100-year event. These events are typically used to design stormwater control and treatment facilities. The guidance document was used to calculate peak flows and runoff volumes for the contributing basin above Perennial Stream 1-A within the Central Basin (Table 15). Monthly average flow estimates for the contributing basin above Perennial Stream 1-A were also calculated and are presented in Table 16.

The USACE Hydrologic Engineering Center River Analysis System (HEC-RAS) model Version 6.1.0 (HEC 2021) was used to calculate water surface elevations, top flow width, channel velocities, shear stress, and other hydraulic characteristics associated with the design flows listed in Table 17. HEC-RAS sections used in the model are illustrated in Figure D-1 of Appendix D. The model cross sections were extracted from the proposed grading surface. The cross sections were placed in key locations of interest, perpendicular to the stream though the site. The downstream model boundary (River Station [RS] 13) was located at a natural flow transition to supercritical flow where the existing stream flows over a steep bluff in the southeast portion of the site. The upstream model boundary was located upstream of the planned improvements (RS 1756). The starting water surface elevation was associated with a normal depth and channel slope of 8 percent. The Manning roughness coefficient for the shallow stream channel through the wetland areas was set at 0.25, consistent with

a rocky channel bed associated with lower flows. Roughness for the wetland areas and stream channel sections not flowing through a wetland area was set at 0.03.

Cross-sectional profiles for select cross sections of the modeled reach for the flows presented in Table 17 are included as figures in Appendix D. In general, the model suggests that during the growing season, average monthly flows will saturate the wetland soils in the mitigation areas. During the late summer, the model suggests that some or all of the wetland areas will be dry, which is typical of existing conditions. A summary table of results for all the modeled cross sections shown in Figure D-1 (Appendix D) is also included in Appendix D.

Table 15
Upper Central Basin Contributing Peak Flow and Runoff Volume Summary

Parameter	Water Quality Event	2-Year Event	10-Year Event	100-Year Event
Basin Area (acres)	44.07	44.07	44.07	44.07
Curve Number	81.50	81.50	81.50	81.50
24-Hour Precipitation (inches)	0.67	2	3	4
Peak Flow (cubic feet per second)	0.11	2.38	6.90	12.42
Runoff Volume (cubic feet)	3,003	100,212	215,344	345,903

Table 16
Upper Central Basin Contributing Average Monthly Flow

Month	Gallons per Minute	Month	Gallons per Minute
January	182.90	July	17.38
February	151.80	August	10.97
March	160.03	September	10.97
April	103.34	October	15.55
May	54.87	November	56.70
June	32.01	December	140.83

Table 17
HEC-RAS Modeled Flow Rates for Mitigation Design

Flow Profile	Description	Flow Rate (cfs)
PF1	Late Summer Low Flows	0.054
PF2	Monthly Average Flow for March	0.79
PF3	Monthly Average Flow for January	0.90
PF4	2-year Return Interval Peak Flow	5.26
PF 5	10-year Return Interval Peak Flow	15.23

6.2.1.3 Slope and Depressional Palustrine Forest and Wet Prairie Areas

Wetlands M-1 and M-2 in the Central Basin will be created to mitigate for impacts to PFO/PSS/PEM Slope, Depressional, and Depressional Outflow wetlands. The mitigation areas are located on primarily basalt bedrock and would be excavated to elevations that would capture direct precipitation and overland flow and intercept shallow groundwater and provide similar conditions to those found in other PFO/PSS/PEM Slope, Depressional, and Depressional Outflow wetlands at the impact site. That is, depressional areas will be created in the bedrock to allow water to spread out and pond in the main wetland areas. Water would flow out during high flows similar to existing flow-through conditions. Any fissures in the bedrock would be sealed with clay or similar materials to prevent water from infiltrating. Soil depths will be greater than 1 foot, and the areas will be planted with native trees to provide PFO habitat, along with native shrubs and herbaceous plant species to create a scrub-shrub and emergent understory.

Wetlands M-4, M-5, M-6, M-7, M-8, M-9, and M-10 will be wet prairie and wet rock outcrop wetlands created to mitigate for ARSC wetland impacts. Wet prairie and wet rock outcrop wetlands are rare ecosystems primarily because of the shallow soil depth to bedrock, the seasonality of their hydroperiod, and the specific plants that are found in them. These mitigation areas will have shallow soils over bedrock, which would be excavated to create bedrock shallow depressions that will be evaluated for hydrology to ensure ponded water in the early growing season, similar to impacted ARSC wetlands. Any fissures in the bedrock would be sealed with clay or similar materials to prevent water from infiltrating. Primary hydrologic sources will include capturing direct precipitation and overland flow and interception of shallow groundwater. Secondary hydrologic sources may come from overbank flow from the created Perennial Stream MS-1 during high water periods, but Wetlands M-4, M-5, M-6, M-7, M-8, M-9, and M-10 will not be dependent on this overbank flow for wetland hydrology.

Wet prairie and wet rock outcrop areas (Wetlands M-4, M-5, M-6, M-7, M-8, M-9, and M-10) would be created using upland soils from the mitigation area excavation or transported upland soils from the mining area. No wet prairie wetlands would be impacted until it is shown that the created wet prairie wetland areas are successful during a minimum 5-year monitoring period (pending approval by DSL). Soil from the upland areas would be placed over the excavated bedrock graded to retain adequate hydrology for wetland creation. The soil would also be planted and seeded with native species observed at or similar to those at the impact site. The created wetland areas would be monitored for at least 5 years to demonstrate successful creation of wet prairie wetlands. This includes monitoring for sufficient hydrologic conditions to ensure the establishment of and self-sustaining hydric soil formation and wetland plant communities typical of other ARSC wetlands present on the project site. During the minimum 5-year monitoring period, plant communities in existing ARSC wetlands on the project site will be monitored as reference sites and compared to the

mitigation ARSC wetlands to inform trends in vegetation diversity and distribution to account for natural fluctuations among different growing seasons.

Once Knife River demonstrates the successful creation of wet prairie wetlands at a minimum to compensate for the total proposed acreage to be impacted during the minimum 5-year monitoring period, wet prairie wetlands could be impacted by the project. If any of the created wet prairie areas are not successful, the site would be evaluated and adaptively managed to ensure successful creation. If all areas are successful, Knife River would evaluate the potential for creating additional wet prairie areas and coordinate with DSL and USACE to potentially create more of this wetland type instead of the more common PFO wetlands.

6.2.2 Western Basin

The grading plan is provided in Appendix E and identifies the mitigation areas in the Western Basin. These created areas will primarily mitigate impacts to streams and other wetlands in the Eastern Basin and any additional area needed to meet the mitigation requirements.

6.2.2.1 Slope/Depressional Palustrine Forested Wetland

The Slope PFO portion of Wetland M-3 will be created to mitigate for impacts to Slope PFO wetlands. The proposed mitigation area to the north of Wetland C will have a Slope HGM classification, whereas the remaining portions of Wetland M-3 will have a Depressional HGM classification. The Slope PFO portion of Wetland M-3 in the Western Basin will be graded to capture hydrology currently flowing towards Wetland C that flows off site via a perched pipe during periods of high water. Wetland M-3 will be created by lowering portions of the topography adjacent to Wetland C and routing some water from Ephemeral Stream B into this larger area. Elevations are based on inundation observations during site visits, the elevation of existing Wetland C, and shallow groundwater level based on the hydrology study. Ephemeral Stream B has a considerable amount of flow during the winter and spring months and will be able to sustain PFO wetland conditions with PSS and PEM understory components without impacting existing Wetland C. Grading will take into consideration existing trees in the lower elevations that can handle wetter conditions (i.e., western red cedar) and grade around them when feasible. The intent in these areas is to slightly lower the elevation in the majority of the herbaceous areas to create wetland understory conditions with slightly elevated hummock areas dominated by existing and planted native woody vegetation. Specific areas of grading and trees to be left will be flagged in the field prior to grading. Higher elevations will be cleared and graded to 2 feet below final grade, and topsoil from existing wetlands in the mining site will be placed on the created wetland areas to establish a deeper soil conducive to developing PFO wetland conditions.

The Depressional PFO portion of Wetland M-3 will be created to mitigate for impacts to Depressional PFO wetlands. The mitigation area would be excavated to an elevation that would

capture direct precipitation and overland flow and intercept groundwater and provide similar conditions to those found in other Depressional PFO wetlands on the project site. The grading elevations are based on the depth to groundwater observed in the piezometer placed in this basin. Groundwater was present at this elevation and by lowering the soil surface, conditions conducive to establishing hydrophytic vegetation will be established. If any fissures are encountered in the bedrock, they would be sealed with clay or similar materials to slow infiltration. Soil depths would be greater than 1 foot, and the area will be planted with native trees to provide PFO habitat, along with native shrubs and herbaceous species to create a scrub-shrub and emergent understory.

6.3 Planting Plan

The planting plan is designed to enhance and support areas of creation for on-site mitigation and mimic natural conditions (species composition, diversity, and abundance) on the project site, as well as restore upland areas (e.g., riparian zones) affected by mitigation construction (Figures 7a through 7f). It will consist of multiple vegetation communities including a mix of forested, scrub-shrub, and emergent wetland, streamside, and riparian habitats. Table 18 provides a representative list of native trees and shrubs that would be incorporated into the planting plan for forested and scrub-shrub portions of created wetland habitats. Table 19 provides a representative list of native graminoids and forbs that would be planted in the emergent portions of created wetland habitats, including created wet prairie and wet rock outcrop ARSC wetland habitats. Table 20 provides a list of native trees and shrubs that would be planted to enhance, restore, and support riparian zones adjacent to existing and created wetland and stream habitats. Plantings will be tailored to the moisture and light conditions required by species selected for the plan. Planting densities will be adjusted based on current site conditions and will be designed to enhance and improve upon those site conditions. The final plant selection will be subject to availability and agreement with the agencies. Forested, scrub-shrub, emergent, and wet prairie/wet rock outcrop ARSC wetland habitats will be seeded and planted with native graminoid and forb species common in these local habitats. Wetlands M-4, M-5, M-6, M-7, M-8, M-9, and M-10 will be depressional wetland habitats planted with species common in the wet prairie and wet rock outcrop ARSC wetlands present in the impact site.

Forested, scrub-shrub, and emergent communities will be planted in created Wetlands M-1, M-2, and M-3 and in the enhancement areas of Wetlands A, B, C, F, G, and TT. These wetland habitats will be planted with native trees, shrubs, and herbaceous species. Tables 17 and 18 provide a list of plant species by wetland habitat types that may potentially be incorporated into the mitigation areas. The final species mix of woody and herbaceous species will be based on availability and will be of a density that is specific to the species. The final species list is anticipated to comprise over 25 native graminoid and forb species. The final species mix and pounds per acre will be developed with the seed source vendors. Tree species will be planted at 7-foot on-center spacing and shrub species

4-foot on-center spacing. The final species list and numbers (pounds per acre and on-center spacing results) will be provided to DSL and USACE for approval prior to purchase.

Environmental preferences of the species listed in Tables 17 and 18 for the planting plan were determined based on wetland indicator status and past experience with seeding and planting species in previous mitigation efforts. Observations of hydrology patterns after mitigation area preparation will guide the final design of the planting and seeding. The planting will be designed to accommodate flood tolerances of various wetland species and to mimic zonation of plant communities found in wet prairie and wet forested/scrub-shrub/herbaceous habitats (Figures 7a through 7f). The planting plan is intended to maximize the biodiversity of species within the habitats of the created wetlands.

A multiyear planting strategy will be implemented in the mitigation areas. At this time, a specific nursery has not been selected to provide plants and seed. Nurseries will be contacted to establish agreements for contract growing the needed plants and seeds and the final species selection and numbers will be coordinated with DSL and USACE. Nurseries that have been identified as potential sources of plants and seeds to support the mitigation plan are listed in Table 21. Several of these nurseries (e.g., Northwest Meadowscares, Sevenoaks Native Nursery, Scholls Valley Native Nursery, Silver Falls Seed Company, Oregon Wholesale Seed Company) provide plants typically found in wet prairie/wet rock outcrop ARSC wetlands, such as common camas (*Camassia quamash*), fragrant popcorn flower (*Plagiobothrys figuratus*), white brodiaea (*Triteleia yacinthine*), tufted hairgrass (*Deschampsia caespitosa*), and a variety of sedges (*Carex* spp.). In addition, planting of mitigation areas will be augmented with native plant species transplanted from the mining area.

Table 18
Native Woody Species Plantings for Forested and Scrub-Shrub Wetlands

Species	Indicator Status	On-Center Spacing (feet)	Plant Numbers
Forested and Scrub-Shrub Portions of Wetlands M-1, M-2, and M-3			
<u>Trees (0.01 per square foot)</u>			
Black cottonwood (<i>Populus balsamifera</i> ssp. <i>Trichocarpa</i>)	FAC	7	1,871
Oregon ash (<i>Fraxinus latifolia</i>)	FACW	7	1,871
Pacific willow (<i>Salix lasiandra</i>)	FACW	7	1,122
Red alder (<i>Alnus rubra</i>)	FAC	7	1,123
Sitka spruce (<i>Picea sitchensis</i>)	FAC	7	749
Western red cedar (<i>Thuja plicata</i>)	FAC	7	749
Tree Subtotal			7,485
<u>Shrubs (0.05 per square foot)</u>			
Black hawthorn (<i>Crataegus douglasii</i>)	FAC	4	4,491
Bunchberry dogwood (<i>Cornus canadensis</i>)	FAC	4	4,491
Cluster rose (<i>Rosa pisocarpa</i>)	FAC	4	3,368
Douglas spirea (<i>Spiraea douglasii</i>)	FACW	4	3,743
Oregon crab apple (<i>Malus fusca</i>)	FACW	4	4,491
Pacific ninebark (<i>Physocarpus capitatus</i>)	FACW	4	3,743
Red osier dogwood (<i>Cornus stolonifera</i>)	FACW	4	3,743
Sitka willow (<i>Salix sitchensis</i>)	FACW	4	4,491
Twinberry honeysuckle (<i>Lonicera involucrata</i>)	FAC	4	4,866
Shrub Subtotal			37,427
Total Plants			44,912

Table 19

Native Herbaceous Species Plantings for Emergent and Wet Prairie/Wet Rock Outcrop ARSC Wetlands

Species	Indicator Status	Form	
		Bare Root, Plug, Container	Seed
Emergent Portions of Wetlands M-1, M-2, and M-3			
<u>Graminoids and Forbs</u>			
American sloughgrass (<i>Beckmannia syzigachne</i>)	OBL		X
Big leaf lupine (<i>Lupinus polyphyllus</i>)	FAC	X	X
Dagger-leaf rush (<i>Juncus ensifolius</i>)	FACW	X	X
Darkthroat shootingstar (<i>Dodecatheon pulchellum</i>)	FACW	X	X
Devil's beggartick (<i>Bidens frondosa</i>)	FACW		X
Hardstem bulrush (<i>Schoenoplectus acutus</i>)	OBL	X	
Needle spike rush (<i>Eleocharis acicularis</i>)	OBL		X
Oregon saxifrage (<i>Micranthes oregana</i>)	FACW	X	X
Red columbine (<i>Aquilegia formosa</i>)	FAC		X
Saw-beaked sedge (<i>Carex stipata</i>)	OBL	X	X
Slough sedge (<i>Carex obnupta</i>)	OBL	X	X
Small-fruited bulrush (<i>Scirpus microcarpus</i>)	OBL	X	X
Soft-stem bulrush (<i>Schoenoplectus tabernaemontani</i>)	OBL	X	X
Stream violet (<i>Viola glabella</i>)	FACW		X
Wet Prairie/Wet Rock Outcrop (ARSC Wetlands M-4, M-5, M-6, M-7, M-8, M-9, and M-10)			
<u>Graminoids and Forbs</u>			
California oatgrass (<i>Danthonia californica</i>)	FAC		X
Common camas (<i>Camassia quamash</i>)	FACW	X	X
Creeping spike rush (<i>Eleocharis palustris</i>)	OBL	X	X
Dense sedge (<i>Carex densa</i>)	OBL	X	X
Fool's onion (<i>Triteleia hyacinthina</i>)	FAC	X	X
Fragrant popcorn flower (<i>Plagiobothrys figuratus</i>)	FACW		X
Great camas (<i>Camassia leichtlinii</i>)	FACW	X	X
Meadow popcorn flower (<i>Plagiobothrys scouleri</i>)	FACW		X
Meadow barley (<i>Hordeum brachyantherum</i>)	FACW		X
Nuttall's quillwort (<i>Isoetes nuttallii</i>)	OBL		X
Seep monkeyflower (<i>Mimulus guttatus</i>)	OBL	X	X
Tufted hairgrass (<i>Deschampsia caespitosa</i>)	FACW		X

Table 20
Woody Native Species Plantings for Riparian Areas

Species	Indicator Status	On-Center Spacing (feet)	Plant Numbers
Riparian and Perennial Streamside Habitats (Perennial Stream MS-1)			
<u>Trees (0.01 per square foot)</u>			
Big leaf maple (<i>Acer macrophyllum</i>)	FACU	7	1,609
Bitter cherry (<i>Prunus emarginata</i>)	FACU	7	2,682
Cascara buckthorn (<i>Rhamnus purshiana</i>)	FAC	7	1,341
Grand fir (<i>Abies grandis</i>)	FACU	7	2,682
Oregon white oak (<i>Quercus garryana</i>)	FAC	7	2,012
Willamette Valley ponderosa pine (<i>Pinus ponderosa</i> var. <i>benthamiana</i>)	FAC	7	3,085
Tree Subtotal			13,411
<u>Shrubs (0.05 per square foot)</u>			
Cascade Oregon-Grape (<i>Mahonia nervosa</i>)	FACU	4	5,364
Common snowberry (<i>Symphoricarpos albus</i>)	FACU	4	8,717
Indian plum (<i>Oemleria cerasiformis</i>)	FACU	4	8,047
Nootka Rose (<i>Rosa nutkana</i>)	FAC	4	7,376
Oceanspray (<i>Holodiscus discolor</i>)	FACU	4	8,047
Red elderberry (<i>Sambucus racemosa</i>)	FACU	4	8,717
Red flowering currant (<i>Ribes sanguineum</i>)	FACU	4	5,364
Saskatoon serviceberry (<i>Amelanchier alnifolia</i>)	FACU	4	6,707
Shrub Subtotal			67,056
Total Plants			80,467

Table 21
Potential Plant and Seed Nurseries

Nurseries		
Plants		Seed
Aurora Nursery 22821 Boones Ferry Road Aurora, Oregon 97070 (503) 678-7903 www.auroranursery.com	Nursery Guide Oregon Association of Nurseries 29751 SW Town Center Loop W. Wilsonville, Oregon 97070 (503) 682-5089 www.nurseryguide.com	Silver Falls Seed Company 5648 Evans Valley Loop NE Silverton, Oregon 97381 (503) 873-8861 https://silverfallsseed.com/product/camas-common/
Beaverlake Nursery 21200 S. Ferguson Road Oregon City, Oregon 97045 (503) 632-4787 www.beaverlakenursery.com	Scholls Valley Native Nursery 4036 NW Half Mile Lane Forest Grove, Oregon 97116 (503) 624-1766 www.schollsvally.com	Pro Time Lawn Seed 1712 SE Ankeny Street Portland, Oregon 97214 (800) 345-3295 www.ptlawnseed.com
Brooks Tree Farm 9785 Portland Road Salem, Oregon 97035 (503) 393-6300 www.brookstreefarm.com	Sevenoaks Native Nursery 29730 Harvest Drive SW Albany, Oregon 97321 (541) 757-6520 www.sevenoaksnativenursery.com	Native Seed Network 563 SW Jefferson Avenue Corvallis, Oregon 97333 (541) 753-3099 https://appliedeco.org/nativeseednetwork/find-seed/
Cascadian Nurseries 8900 NW Dick Road Hillsboro, Oregon 97124 (503) 647-9292 www.cascadiannurseries.com	Valley Growers Nursery 30570 Barlow Road Hubbard, Oregon 97032 (503) 651-3535 www.valleygrowers.com	River Refuge Seed Company 26366 Gap Road, Brownsville Oregon 97327 (541) 466-5309 www.riverrefugeseed.com
Champoeg Nursery 9661 Yergen Road NE Aurora, Oregon 97002 (503) 678-6348 www.champoegnursery.com	Watershed Garden Works 2039 44 th Avenue Longview, Washington 98632 (360) 423-6456 www.watershedgardenworks.com	Sunmark Seeds 12775 NE Marx Street, Building 14 Portland, Oregon 97230 (503) 241-7333 www.sunmarkseeds.com
Northwest Native Plants, Inc. 23501 Beatie Road Oregon City, Oregon 97045 (503) 632-7079 www.plantnative.org	Northwest Meadowsclapes 1240 W. Sims Way, #218 Port Townsend, Washington 98368 (360) 504-6415 https://northwestmeadowsclapes.com/	Oregon Wholesale Seed Company 5648 Evans Valley Loop NE Silverton, Oregon 97381 (503) 874-8221 https://oregonwholesaleseed.com/

6.4 Construction Schedule

Mitigation area construction will occur in the following phases:

1. Site grading and preparation
2. Initial hydrologic monitoring
3. Site planting
4. Hydrologic monitoring and final planting plan development

Sequencing of specific construction elements will include the following:

- Installing erosion control measures, marking the construction limits, and identifying staging and stockpiling areas
- Grading of the mitigation design as described in Section 6.2
- Assessing all graded surfaces for any fissures in the bedrock and sealing those fissures with clay or similar materials to slow infiltration
- Using mitigation area preparation measures to eradicate the non-native seed bank
- Spreading topsoil to appropriate depths for PFO, PEM, and wet prairie creation
- Installing woody material as described in Section 6.1
- Implementing the planting plan as described in Section 6.3
- Controlling non-native species in the mitigation area during the monitoring period
- Adaptively managing any parts as needed throughout the monitoring period

Construction of the mitigation area will occur between the hours of 7:00 a.m. and 6:00 p.m., similar to current operations and as required by the Columbia County Zoning Code and other state and federal standards (such as the Oregon Department of Environmental Quality [DEQ] standards for noise [OAR 340-035-0035]), to minimize construction noise and vibration impacts. In addition, engineering controls would be employed to mitigate for noise and vibration impacts and may include using acoustic barriers and covering the stone crushing and screening plants and systems. Accurate noise monitoring during construction would be implemented according to project approvals and regulations.

The Stormwater Pollution Prevention Plan (Attachment F to JPA) provides information on how dust control will be handled at the Phase II site. Excavated material in the migration area will be processed at the Phase I site. The crushing plant at the Phase I site has a DEQ Air Contaminant Discharge Permit, which regulates not only emissions from this source but any fugitive dust from haul roads on site. The plant has water spray nozzles at the crushers and transfer points to minimize particulate matter in the air. All the haul roads on site are gravel, and water is used if necessary to keep any fugitive dust down. The Phase I site has adequate pavement at the exit to prevent track-out of materials. If track-out becomes an issue, a street sweeper is used to clean up the roadway surface at U.S. Highway 30.

The Applicant will implement these measures as needed to ensure compliance with their DEQ Air Contaminant Discharge Permit.

To ensure self-sustaining hydrological conditions for wetland and stream creation in the Western Basin, soil and bedrock will be excavated to create the Perennial Stream MS-1 channel and associated fringe wetland complex (Wetland M-1) and Wetland M-2. Once excavation is complete, the exposed soil and bedrock conditions will be evaluated to determine if the created stream channel and fringe wetland areas are adequately directing and holding water. Additional grading may be needed after site hydrologic patterns are assessed to ensure proper hydrology and adequate depth of soil can be achieved. The remaining wetland creation area (Wetland M-3) in the Western Basin would be excavated to elevations that would capture ephemeral stream flow, direct precipitation, overland flow, and shallow groundwater to ensure adequate self-sustaining hydrology. To ensure successful creation of ARSC wetlands, Wetlands M-4, M-5, M-6, M-7, M-8, M-9, and M-10 would be monitored during a 5-year period to demonstrate successful creation of wet prairie wetlands prior to impacting the existing ARSC wet prairie wetlands in the mining area. Once successful creation of ARSC wet prairie wetlands have been demonstrated, the emergent and ARSC wet prairie wetlands at the impact site would be used for soil in mitigation areas as needed and potentially in additional creation areas as coordinated with DSL and USACE.

Once all required permits for the project are issued, Knife River would commence mitigation construction and the first stage of mining activities in the Eastern Basin. Phase II mining would occur over three mining stages (Figure 9 of the JPA). Each mining stage would last about 13 to 15 years, pending market demand, and would be consecutive (i.e., the second stage would not commence until the first stage is complete) with the first stage occurring mainly in the Eastern Basin before moving into the Central Basin for the remaining stages. Stage 1 mining activities would avoid direct impacts to Wetland M and all ARSC wetlands on the project site. Constructing the mitigation including the perennial channel (Perennial Stream MS-1) years before Wetland M is directly impacted will also allow for adaptive management, if needed, to ensure adequate hydrology and successful mitigation before direct impacts occur. Following demonstrating successful ARSC wetland mitigation creation in coordination with the agencies, Phase II mining would occur over the remaining stages.

7 Monitoring Plan

The Compensatory Mitigation Plan will include creation of wetlands and a perennial stream, including protective buffers. For wetlands, the acre-replacement ratio was determined using DSL's Compensatory Mitigation Eligibility and Accounting Determination methodology, which calculated a creation ratio of 1.5:1. As such, 18.32 acres of created wetlands will provide the required 17.34 credits for mitigation for 11.56 acres of impacted wetland. To ensure the success of the mitigation, the following monitoring plan will be followed. Because most direct wetland impacts will occur after the mitigation is completed and the monitoring is underway or completed, if any of the success criteria is not met, there is time for corrective action and adaptive management prior to most direct impacts occurring. This enables potential corrections or changes to the wetland design (e.g., more wet prairie, different plants, regrading) to occur before most direct impacts. To alleviate any potential indirect impacts to the remaining wetlands due to mitigation creation or mining activities, the remaining wetlands on and immediately downslope from the project site will be monitored for potential changes in wetland conditions (e.g., plants, soils, hydrology). Baseline conditions will be established using previous delineations and pre-construction monitoring via a light delineation.

7.1 Goals, Objectives, and Performance Standards

The goal of the Plan is to create wetland diversity and improved wetland functions in the mitigation areas, as well as preservation of the existing remaining wetlands. The mitigation design includes creation of wet prairie habitats, small depressions, and forested wetlands with scrub -shrub and emergent components. Some wetland enhancement of remaining degraded wetlands will also occur to improve the success of creating a biodiverse community of native plants in the created wetlands, but these enhancement areas in the existing wetlands are not included as part of the compensatory mitigation requirements. Specific goals, objectives, and performance standards for the mitigation areas are provided in Table 22.

During the monitoring period, maintenance activities and adaptive management will be performed as needed, including the installation of animal damage protection devices and annual non-native vegetation management. A minimum of two project site visits will be conducted per year (e.g., spring and fall) to monitor project site conditions. Maintenance visits will be conducted as needed to address any issues with project site performance. Examples of issues that would be addressed during normal maintenance include exposed soil areas being reseeded or replanted consistent with the planting plan and replanting of plants damaged by wildlife or improper irrigation at the appropriate time of year for the target plant species. If plant establishment becomes a long-term problem, the reasons for the problems will be identified, discussed with the agencies, and corrected.

**Table 22
Mitigation Goals, Objectives, and Performance Standards**

Goal, Objective, or Performance Standard	Description
Goal 1—Central Basin	Establish 1.12 acres of stream and 9.39 acres of wetland habitat (Wetlands M-1 and M-2) in the Central Basin through creation with an emphasis on native forested, scrub-shrub, and emergent species similar to those in the impacted portion of Wetland M.
Objective	Create 5,222 linear feet (1.12 acres) of stream and 9.39 acres of PFO/PSS/PEM Cowardin wetlands.
Performance Standard 1.1	After 5 years of vegetation establishment, the mitigation areas will have a minimum of 9.39 acres of Depressional/Depressional Outflow HGM, PFO/PSS/PEM Cowardin wetlands as determined by assessing the mitigation areas during spring of a normal precipitation year once vegetation has been established.
Performance Standard 1.2	After 1 year, the mitigation design will have 5,222 linear feet of perennial stream flowing around the quarry and off site at the current Wetland M discharge point as determined by assessing the mitigation area during spring of a normal precipitation year.
Performance Standard 1.3	The cover of native species, as defined in the U.S. Department of Agriculture database, in the herbaceous stratum is at least 60% at Year 5.
Performance Standard 1.4	Woody vegetation, including volunteer plants that become established, will have an 80% survival rate throughout the monitoring period.
Performance Standard 1.5	The cover of woody invasive species will not be more than 10% and the cover of herbaceous invasive species will not be more than 25%, if approved by the agencies, throughout the monitoring period when desirable canopy species comprise less than 50% cover. Invasive species include any species listed on the Oregon Department of Agriculture Noxious Weed List and other problematic wetland species, such as <i>Phalaris arundinacea</i> , <i>Mentha pulegium</i> , and <i>Lythrum salicaria</i> . Beginning in Year 2, non-native nuisance species may be considered as invasive, should they exceed more than 15% cover in established sample plots and show an increasing trend. After the site has matured to the stage when desirable canopy species reach 50% cover, the cover of invasive understory species may increase but may not exceed 30%.
Performance Standard 1.6	By Year 3, at least six different native species will have at least 10% average cover in each Cowardin class and occur in at least 10% of the plots sampled.
Performance Standard 1.6	Bare substrate represents no more than 20% cover in emergent-only wetland areas at Year 5.
Performance Standard 1.8	Prevalence Index scores must be less than 3.0.
Performance Standard 1.9	By Year 3, the stream will have established channels through the wetland complex as determined by photographic documentation during spring of a normal precipitation year.

Goal, Objective, or Performance Standard	Description
Goal 2—Central Basin	Establish 1.30 acres of wet prairie/wet rock outcrop ARSC wetlands (Wetlands M-4, M-5, M-6, M-7, M-8, M-9, and M-10) in the Central Basin through creation with an emphasis on native emergent species similar to the impacted wet prairie/wet rock outcrop wetlands.
Objective	Create 1.30 acres of PEM wetlands that will also meet the definition of ARSC under OAR 141-085-510(3).
Performance Standard 2.1	After 3 years of vegetation establishment, the mitigation areas will have a minimum of 0.92 acre of Depressional/Depressional Outflow HGM and PEM Cowardin wetlands that meet the definition of ARSC as determined by assessing the mitigation areas during the growing season of a normal precipitation year, to ensure the minimum ratio or required mitigation is achieved.
Performance Standard 2.2	By Year 3, at least four different native wet prairie/wet rock outcrop plant species will have at least 20% average cover each for a total cover of 80% in the PEM Cowardin class and occur in at least 75% of the plots sampled or comparable to coverage in the existing unimpacted ARSC wetlands on the project site.
Performance Standard 2.3	Bare substrate represents no more than 10% cover in wetlands at Year 3.
Performance Standard 2.4	During Year 3 monitoring, evidence of saturation to the surface or ponded conditions in 50% of the mitigation area is present during the growing season of a normal precipitation year. Evidence of saturation to the surface or ponded conditions may include observations of surface water, soil saturation at the surface, or hydric soil conditions.
Performance Standard 2.4	After 5 years of vegetation establishment, the mitigation areas will have a minimum of 1.30 acres of Depressional/Depressional Outflow HGM and PEM Cowardin wetlands that meet the definition of ARSC as determined by assessing the mitigation areas during spring of a normal precipitation year once vegetation has been established.
Performance Standard 2.5	The cover of native wet prairie/wet rock outcrop plant species, as defined in the U.S. Department of Agriculture database, in the herbaceous stratum is at least 80% at Year 5 or comparable to coverage in the existing ARSC wetlands on the project site.
Performance Standard 2.6	The cover of invasive species will not be more than 10%. Invasive species include any species listed on the Oregon Department of Agriculture Noxious Weed List and other problematic wetland species, such as <i>Phalaris arundinacea</i> , <i>Mentha puleguim</i> , and <i>Lythrum salicaria</i> . Beginning in Year 2, non-native nuisance species may be considered as invasive should they exceed 15% cover in established sample plots and show an increasing trend.
Performance Standard 2.7	Bare substrate represents no more than 20% cover at Year 5.
Performance Standard 2.8	Prevalence Index scores must be less than 3.0.

Goal, Objective, or Performance Standard	Description
Goal 3—Western Basin	Establish 7.63 acres of wetland habitat (Wetland M-3) in the Western Basin through creation with an emphasis on native scrub-shrub, and forested species typical of PFO wetlands in the impact site.
Objective	Create 7.63 acres of PFO/PSS/PEM Cowardin wetlands.
Performance Standard 3.1	After 5 years of vegetation establishment, the mitigation areas will have a minimum of 7.63 acres of Depressional/Slope HGM, PFO/PSS/PEM Cowardin wetlands as determined by assessing the mitigation areas during spring of a normal precipitation year once vegetation has been established.
Performance Standard 3.2	The cover of native species, as defined in the U.S. Department of Agriculture database, in the herbaceous stratum is at least 60% at Year 5.
Performance Standard 3.3	Woody vegetation, including volunteer plants that establish, will have an 80% survival rate throughout the monitoring period.
Performance Standard 3.4	The cover of woody invasive species will not be more than 10% and the cover of herbaceous invasive species will not be more than 25%, if approved by the agencies, throughout the monitoring period when desirable canopy species comprise less than 50% cover. Invasive species include any species listed on the Oregon Department of Agriculture Noxious Weed List and other problematic wetland species, such as <i>Phalaris arundinacea</i> , <i>Mentha puleguim</i> , and <i>Lythrum salicaria</i> . Beginning in Year 2, non-native nuisance species may be considered as invasive should they exceed 25% cover in established sample plots and show an increasing trend. After the site has matured to the stage when desirable canopy species reach 50% cover, the cover of invasive understory species may increase but may not exceed 30%.
Performance Standard 3.5	By Year 3, at least six different native species will have at least 10% average cover in the Cowardin class and occur in at least 10% of the plots sampled.
Performance Standard 3.6	Bare substrate represents no more than 20% cover in emergent-only wetlands at Year 5.
Performance Standard 3.7	Prevalence Index scores must be less than 3.0.
Goal 4—Central and Western Basin	Create wetland hydrology patterns and microtopography typical wetlands in the impact area.
Objective	Establish wetland hydrology characteristics through site grading.
Performance Standard	All created wetlands shall contain 14 or more consecutive days of saturated soils, flooding or ponding, or a water table 12 inches or less below the soil surface, during the growing season at a probability of 50%. This will be assessed with wetland delineations during the monitoring period.

7.2 Monitoring Method

Hydrology will be evaluated after initial mitigation area grading to determine if desired wetland hydroperiods are being achieved in different parts of the mitigation areas. Wetland hydrology will be monitored in the year following final mitigation area grading for the continued presence of wetland hydrology criteria as specified in the 1987 *Corps of Engineers Wetlands Delineation Manual* (Environmental Laboratory 1987). After final mitigation area grading has been approved by a qualified biologist, mitigation area preparation activities will occur for one growing season before seeding and planting will occur.

An as-built survey and report will be prepared to document grading and planting. The report will be completed within 60 days of final mitigation area planting and document any deviations from this Plan. The report will include a topographic survey of the graded mitigation areas.

Vegetation monitoring of the mitigation areas will be performed using the methods described in the DSL *Routine Monitoring Guidance for Vegetation: A Companion Document to the Compensatory Mitigation for Non-Tidal Wetlands and Tidal Waters and Compensatory Non-Wetland Mitigation* (OAR 141-085-0680 to 141-085-0765) (DSL 2009). Plants will be classified according to their habitat requirements, based on the most recent USACE National Wetland Plant List. Annual monitoring surveys and reports will be prepared for a minimum of 5 years following grading and plantings, or as required in the USACE and DSL permits. The annual monitoring reports will also include the monitoring results of the existing remaining wetlands on and immediately downslope from the project site.

Coordination with the various regulatory agencies will take place throughout the monitoring period as required. If the mitigation areas fail to meet performance standards or if there are any indirect impacts to the remaining wetlands, Knife River would promptly notify USACE and DSL to discuss and implement the necessary corrective actions. Knife River will agree to take corrective action as needed, including additional excavation or filling to establish appropriate wetland hydrology, replanting, or other remedies. Any such required corrective action will be agreed upon by Knife River, USACE, and DSL.

7.3 Monitoring Schedule

Vegetation monitoring will occur for at least 5 years after the initial seeding and planting has occurred. Monitoring of the mitigation areas and remaining wetlands will be conducted between April and June and again at the end of the growing season (early Fall) to document hydrologic conditions and vegetation cover and establishment.

After the third and fifth growing seasons, a formal wetland delineation of the mitigation areas will be evaluated and documented for consistency with this Plan. An ORWAP functional assessment of each

created wetland mitigation area and an SFAM of the created stream will be completed as part of these efforts to document post-construction conditions of the mitigation areas. If the first delineation identifies areas of concern, Knife River will coordinate with the agencies to identify ways to ensure adequate wetland acreage will be achieved.

7.4 Rationale for Plot and Photograph Documentation Locations

Monitoring transects will be randomly selected prior to the monitoring period. Transect locations will be marked in the field and identified on the surveyed map. A minimum of five 1-square-meter plots per half acre will be established in PEM wetlands at an even distance along randomly selected transects, and percent absolute cover by species will be documented. A minimum of seven 10-square-meter plots per acre will be established in the PSS and PFO wetlands. Density of woody vegetation will be recorded using stems per acre.

Photograph points will be established in locations where the majority of the wetland mitigation areas can be viewed. The location of the photograph points will be marked in the field and on the final as-built construction report. The coordinates of the photograph point will also be recorded so their locations can be identified if they are removed during the monitoring period.

8 Long-Term Protection and Financial Security Instruments

Knife River anticipates multiple levels of financial and security instruments to ensure that the compensatory mitigation is constructed, monitored, and functioning as prescribed by this Plan. The following provides a description of the proposed financial security instrument, deed restriction, long-term management plans, and funding mechanisms.

8.1 Proposed Protection Instrument

Before construction of the mitigation areas begins, a deed restriction document would be recorded to identify the mitigation areas as a compensatory mitigation. The deed restriction would identify the mitigation areas' preservation in perpetuity for wetland and wildlife purposes and identify prohibited uses. Weyerhaeuser NR Company will file the deed restrictions with Columbia County prior to mitigation construction; executed documents will be submitted to DSL and USACE in the as-built construction report. A draft of the anticipated deed restriction is included as Appendix F.

8.2 Proposed Financial Security Instrument

Prior to beginning construction, a security instrument sufficient to ensure completion and success of the required compensatory mitigation will be provided to DSL and USACE. It is anticipated that security instruments would be surety bonds maintained throughout the monitoring period. In accordance with OAR 171-085-0700(6), security amounts are determined using DSL's Payment Calculator for In-Lieu Fee Programs, Method B6. Total project security needs are first totaled to offset the proposed 11.56-acre wetland impact associated with the quarry. The DSL calculator and detailed tax lot analysis are provided as Appendix G.

In addition to the DSL-required compensatory mitigation financial security, the Oregon Department of Geology and Mineral Industries (DOGAMI) requires a reclamation bond for final reclamation activities at the quarry. When DOGAMI sets a bond amount, this amount will be reported to the agencies. Over the life of the project, the DOGAMI bond may change based on project conditions during annual mitigation area inspections. Upon completion of the aggregate extraction on the project site, reclamation would occur in accordance with County and DOGAMI regulations. Reclamation would include creating a lake feature surrounded by native tree, shrub, and herbaceous vegetation suitable for native wildlife habitat. The reclamation plan would be designed to support the adjacent mitigation areas and remaining wetlands and streams on the project site. Figures 10a and 10b show how the conceptual reclamation plan would look with the final mitigation plan in place.

8.3 Long-Term Management Plan

Monitoring and maintenance throughout each monitoring period would be funded by Knife River. Maintenance would occur as necessary to comply with DSL and USACE permit conditions. All maintenance actions would be identified in the annual monitoring reports.

Upon completion of each 5-year monitoring period, minimal management is anticipated to maintain the success of the mitigation areas. Annual pedestrian surveys would occur to identify invasive weed encroachment, wildlife browsing, and other potential problems that may impact the success of the mitigation areas. Maintenance would occur as recommended to address identified problems.

8.3.1 *Anticipated Long-Term Ownership and Maintenance Actions*

The mitigation areas are presently owned by Weyerhaeuser NR Company and leased by Knife River. Documentation of the lease is provided in Appendix H. If Weyerhaeuser NR Company were to sell or transfer the property, that sale would be subject to the deed restrictions placed on the property and the commitments made between Weyerhaeuser NR Company and Knife River with respect to the mitigation areas.

Annual long-term maintenance actions will include supplemental native plantings and non-native vegetation removal carried out by regional youth organizations and restoration contractors. Management of the mitigation area vegetation may include the use of mowing, hand pulling, or herbicide application to manage biomass accumulation in the mitigation areas and sustain a high native plant biodiversity.

8.3.2 *Entity Responsible for Maintenance*

Knife River will be responsible for maintaining the mitigation areas during the active monitoring and long-term management time frames. Long-term maintenance would be funded by a dedicated financial instrument. Funds would be specifically reserved to cover monitoring, mitigation area evaluation, and maintenance actions such as herbicide application and corrective grading. Identified maintenance tasks would be prioritized in accordance with available funds. Knife River will coordinate an appropriate financial structure for submittal and agency review as part of the final long-term management plan.

8.3.3 *Anticipated Funding Source*

Knife River will fund long-term monitoring and maintenance of the mitigation areas.

9 References

- Adamus, P.R., 2001. *Guidebook for Hydrogeomorphic (HGM)-based Assessment of Oregon Wetland and Riparian Sites: Statewide Classification and Profiles*. Oregon Division of State Lands. February 2001.
- Adamus, P., K. Verble, and M. Rudenko, 2016a. *Manual for the Oregon Rapid Wetland Assessment Protocol*. Version 3.1. Salem: Oregon Department of State Lands. November 2016. Available at: https://www.oregon.gov/dsl/WW/Documents/ORWAP_3_1_Manual_Nov_2016.pdf.
- Adamus, P., J. Morlan, K. Verble, and A. Buckley, 2016b. *Oregon Rapid Wetland Assessment Protocol*. (ORWAP, revised): Version 3.1 Calculator Spreadsheet, Databases, and Data Forms. Salem, Oregon. Oregon Department of State Lands.
- Columbia County, 2001. Columbia County Stormwater and Erosion Control Ordinance. Available online at <https://www.co.columbia.or.us/files/lds/stormwater.pdf>. November 21, 2001.
- Cowardin, L.M., V. Carter, F.C. Golet, and E.T. LaRoe, 1979. *Classification of Wetlands and Deepwater Habitats of the United States*. U.S. Department of the Interior—Fish and Wildlife Service. Washington, D.C. Government Printing Office. December 1979.
- DSL (Oregon Department of State Lands), 2009. *Routine Monitoring Guidance for Vegetation: A Companion Document to the Compensatory Mitigation for Non-Tidal Wetlands and Tidal Waters and Compensatory Non-Wetland Mitigation (OAR 141-085-0680 to 141-085-0765)*. Interim Review Draft Version 1.0. September 23, 2009. Available at: https://www.oregon.gov/dsl/WW/Documents/dsl_routine_monitoring_guidance.pdf.
- Environmental Laboratory, 1987. *Corps of Engineers Wetlands Delineation Manual*. Wetlands Research Program Technical Report Y-87-1. U.S. Army Corps of Engineers Waterway Experiment Station. January 1987.
- HEC (Hydrologic Engineering Center) U.S. Army Corps of Engineers, Davis CA., 2021. HEC-RAS Program Version 6.1.0. <https://www.hec.usace.army.mil/software/hec-ras>.
- Nadeau, T-L., D. Hicks, C. Trowbridge, N. Maness, R. Coulombe, N. Czarnomski. 2018a. *Stream Function Assessment Method for Oregon (SFAM, Version 1.0)*. Oregon Department of State Lands, Salem, Oregon. EPA 910-D-18-001, U.S. Environmental Protection Agency, Region 10, Seattle, Washington. June 2018. Available at: <http://doi.org/10.13140/RG.2.2.36064.12806>.
- Nadeau, T-L., C. Trowbridge, D. Hicks, and R. Coulombe. 2018b. *A Scientific Rationale in Support of the Stream Function Assessment Method for Oregon (SFAM, Version 1.0)*. Oregon Department of State Lands, Salem, Oregon. EPA 910-S-18-001. U.S. Environmental Protection Agency,

Region 10, Seattle, Washington. June 2018. Available at:
[https://www.oregon.gov/dsl/WW/Documents/Stream_Function_Assessment_Method_\(SFAM\)_v_1.0_Scientific%20Rationale.pdf](https://www.oregon.gov/dsl/WW/Documents/Stream_Function_Assessment_Method_(SFAM)_v_1.0_Scientific%20Rationale.pdf).

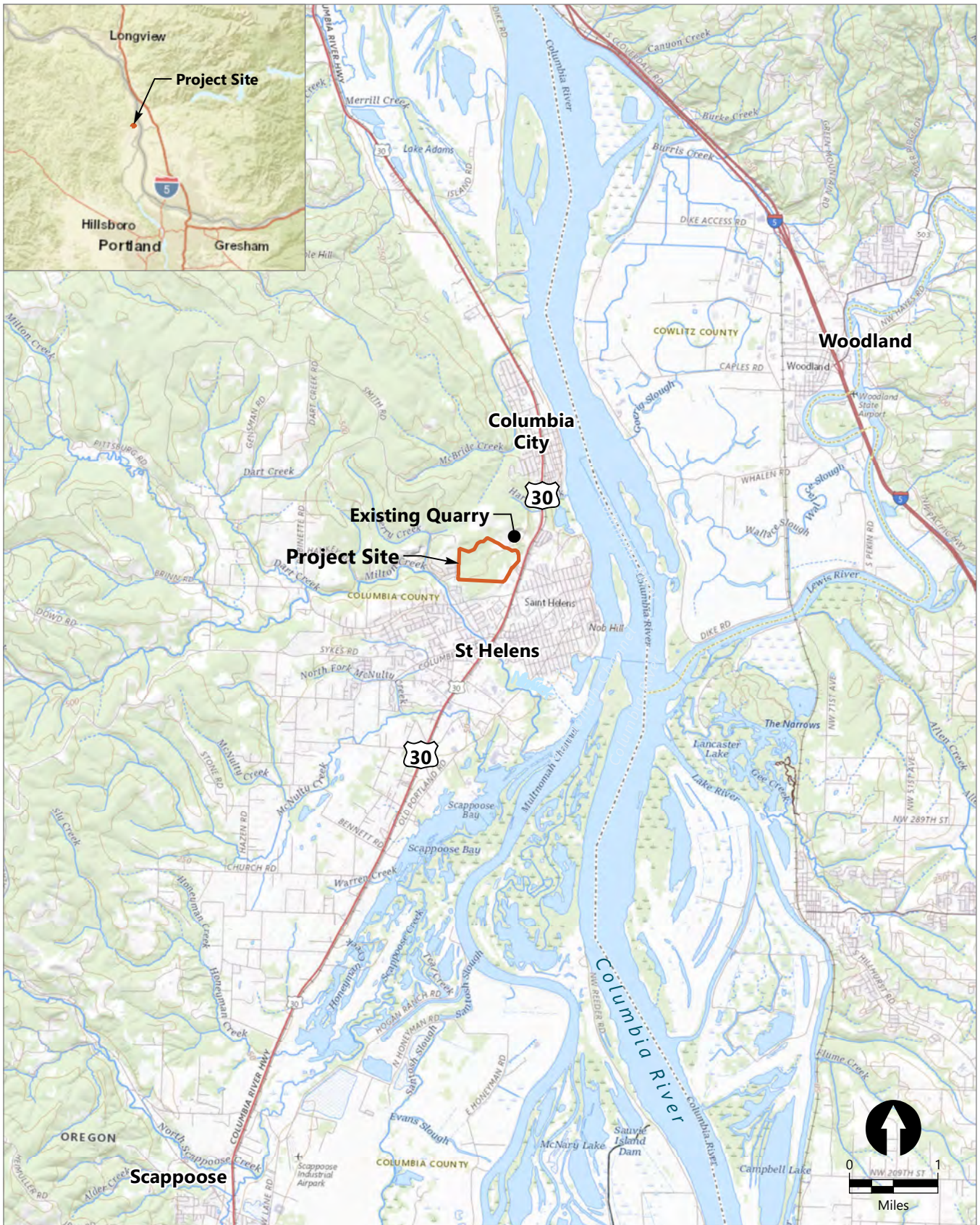
NRCS (Natural Resources Conservation Service), 2020. Web Soil Survey. Soil Survey Staff, Natural Resources Conservation Service, U.S. Department of Agriculture. Accessed February 4, 2020. Available at: <https://websoilsurvey.sc.egov.usda.gov/App/WebSoilSurvey.aspx>.

Oregon Explorer, 2020. Oregon Explorer – Oregon Rapid Wetland Assessment Protocol (ORWAP) and Stream Function Assessment Method (SFAM) Map Viewer. Oregon State University Library and Institute for Natural Resources. Corvallis: Oregon State University. Accessed October 6, 2020. Available at:
http://tools.oregonexplorer.info/oe_map_viewer_2_0/Viewer.html?Viewer=orwap.

Oregon Explorer, 2023. Oregon Explorer – Wet Prairies and Wet Rock Outcrops. Accessed September 16, 2023. Available at: <https://oregonexplorer.info/content/wet-prairies-and-wet-rock-outcrops?topic=4138&ptopic=98>.

Terrapoint, 2005. Lower Columbia River Project Report. Report Presented to Puget Sound Lidar Consortium. December 29, 2005.

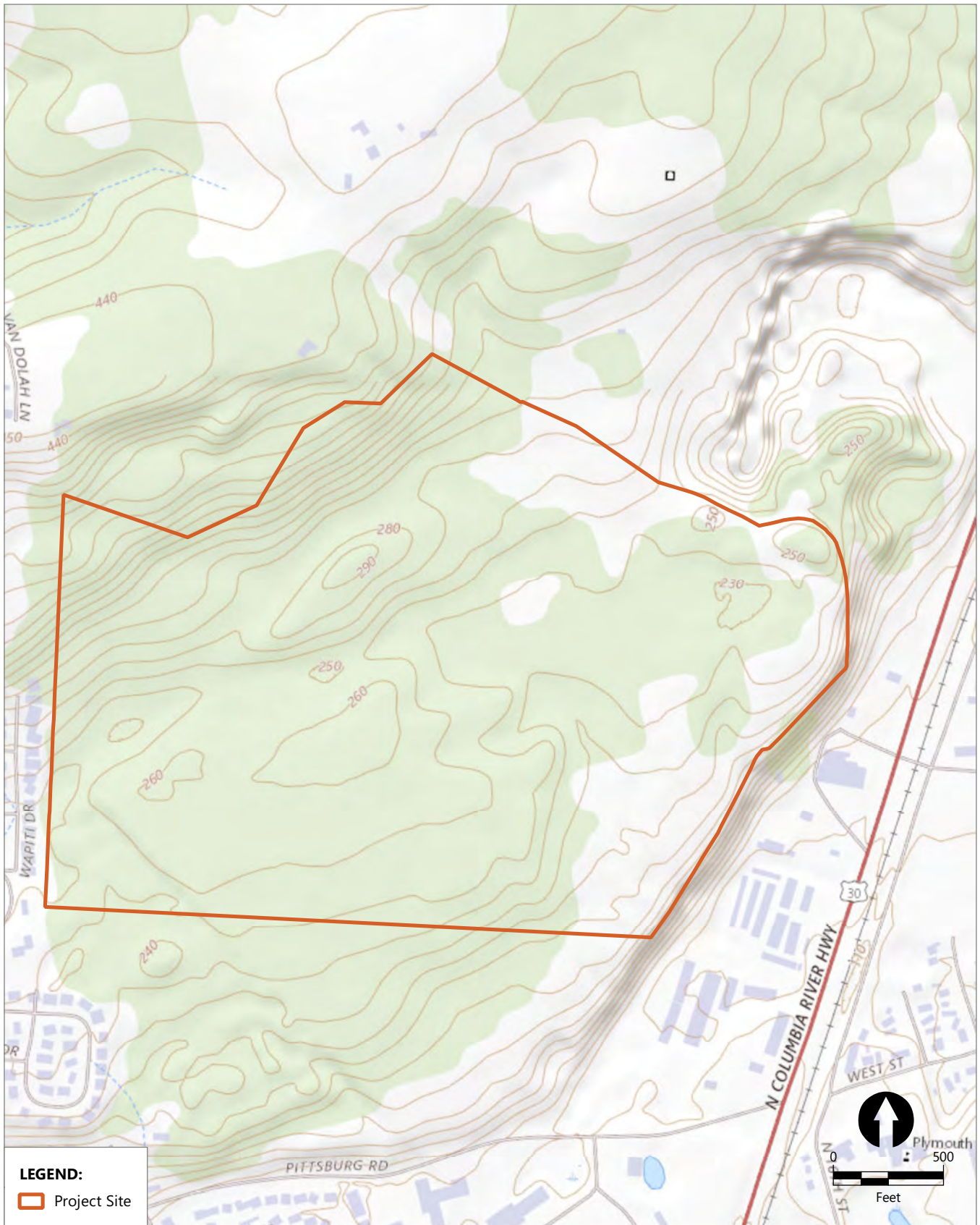
Figures



Publish Date: 2023/12/20, 12:07 PM | User: jfox
Filepath: \\orcas\GIS\Jobs\Knife_River_Corp_2114\Watters_Quarry\Maps\CMP\AQ_CMP_Fig1_Vicinity_Map.mxd



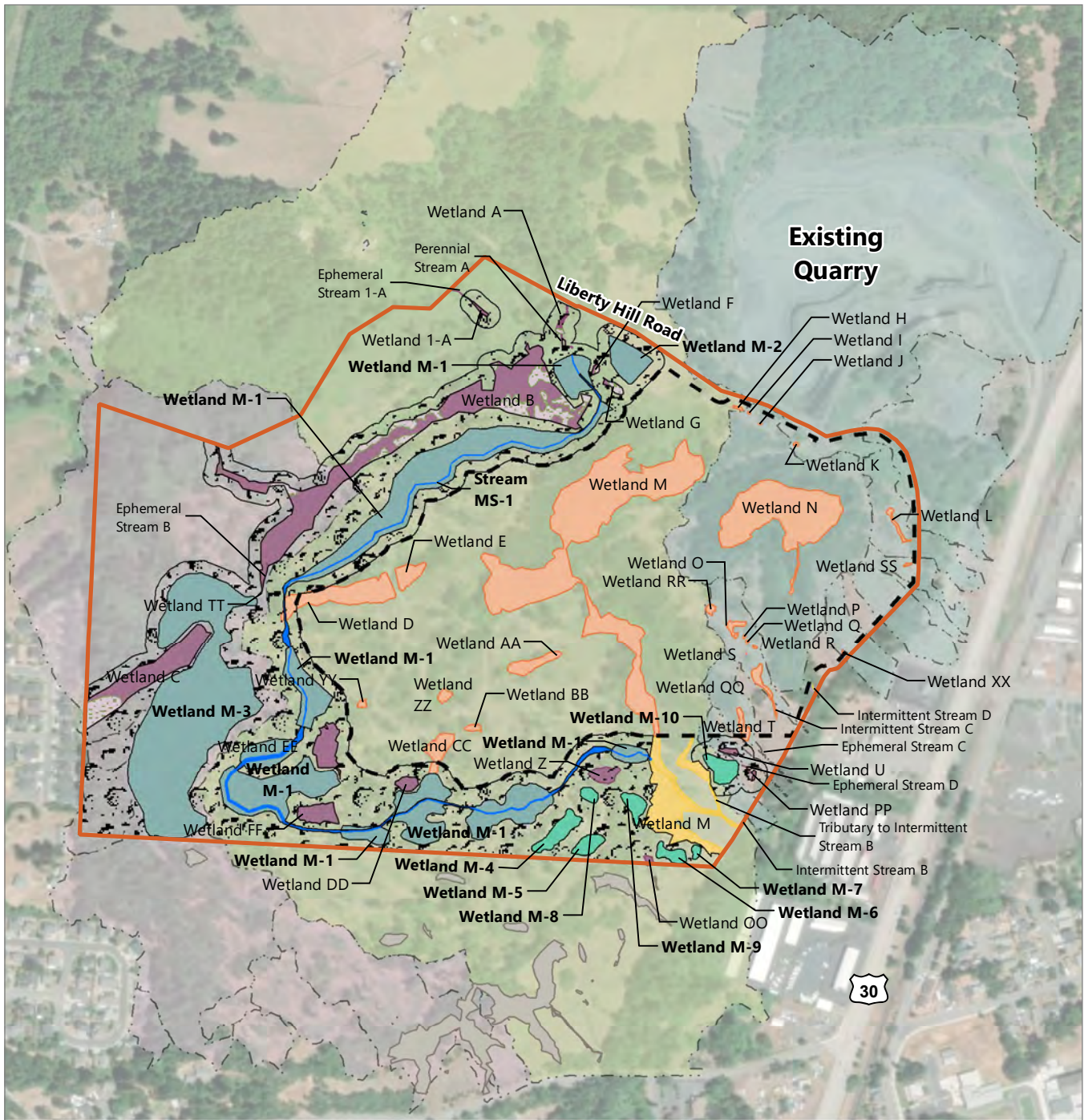
Figure 1
Vicinity Map
Compensatory Mitigation Plan
Watters Quarry Phase II Project



Publish Date: 2023/12/20, 12:08 PM | User: jfox
Filepath: \\orcas\GIS\Jobs\Knife_River_Corp_2114\Watters_Quarry\Maps\CMP\AQ_CMP_Fig2_USGS_Topo_Map.mxd



Figure 2
USGS Topography Map
Compensatory Mitigation Plan
Watters Quarry Phase II Project



LEGEND:

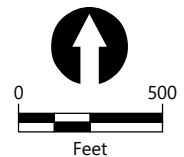
- Project Site
- Proposed Mining Area
- Drainage Basin**
- Eastern Basin
- Central Basin
- Western Basin

- Wetland and Stream Impacts**
- Direct Impact
 - Potential Indirect Impact
 - No Impact
 - No Impact (Off Site)

- Compensatory Mitigation Plan**
- Perennial Stream
 - ARSC Wetland
 - Wetland
 - Wetland Enhancement Area
 - Wetland and Stream Buffer

NOTE:

1. Aerial imagery: Esri (2021)

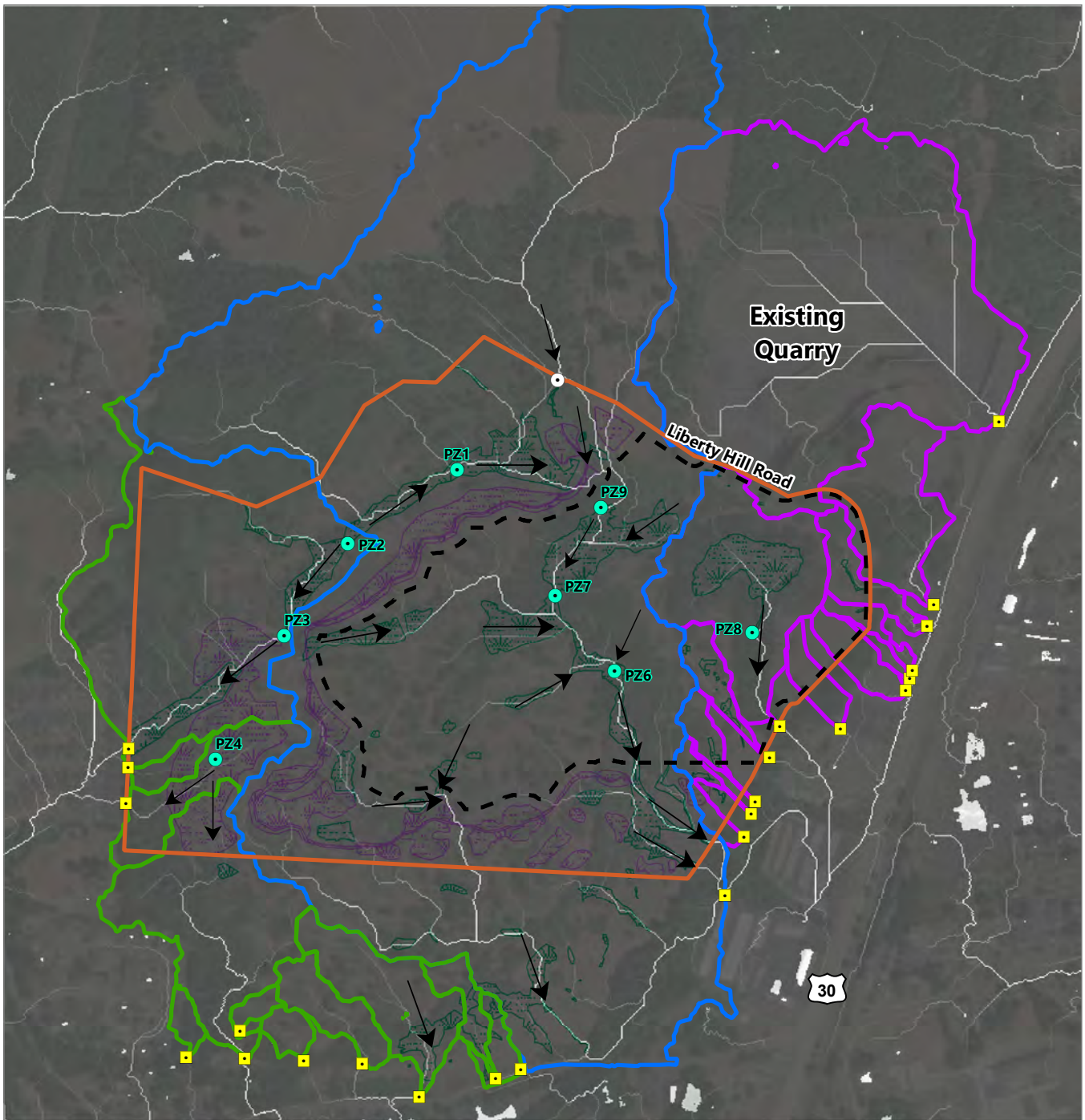


Publish Date: 2023/12/20, 12:09 PM | User: jfox
 Filepath: \\orcas\GIS\Jobs\Knife_River_Corp_2114\Watters_Quarry\Maps\CMP\AQ_CMP_Fig3_CMP_Overview_Map.mxd



Figure 3
Compensatory Mitigation Overview Map

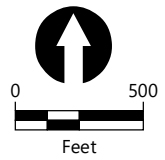
Compensatory Mitigation Plan
 Watters Quarry Phase II Project



LEGEND:

- | | | |
|-------------------------------|-----------------------|---------------------------|
| Project Site | Drainage Basin | Piezometer |
| Proposed Mining Area | Eastern Basin | Surface Outlet Location |
| Existing Wetlands and Streams | Central Basin | Flow Accumulation |
| Created Wetlands and Streams | Western Basin | High : 10000 |
| Dual Culverts | | Low : 0 |
| | | Subsurface Flow Direction |

NOTE:
1. Aerial imagery: Esri (2021)

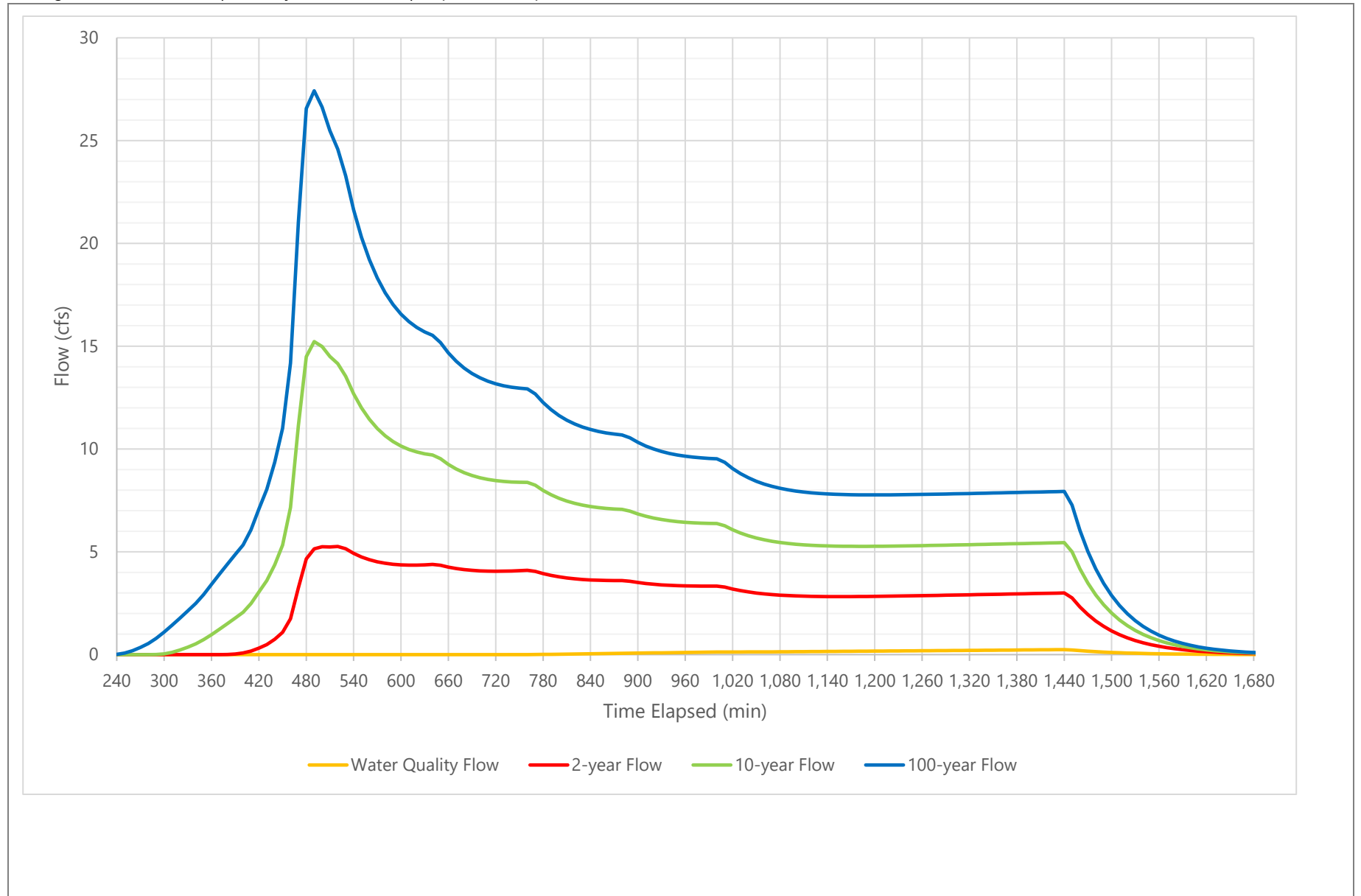


Publish Date: 2023/12/20, 12:10 PM | User: jfox
Filepath: \\orcas\GIS\Jobs\Knife_River_Corp_2114\Watters_Quarry\Maps\CMP\AQ_CMP_Fig4_DrainageBasins_Piezos_Map.mxd



Figure 4
Drainage Basins, Surface Flow Accumulation, and Subsurface Flow Map

Compensatory Mitigation Plan
Watters Quarry Phase II Project

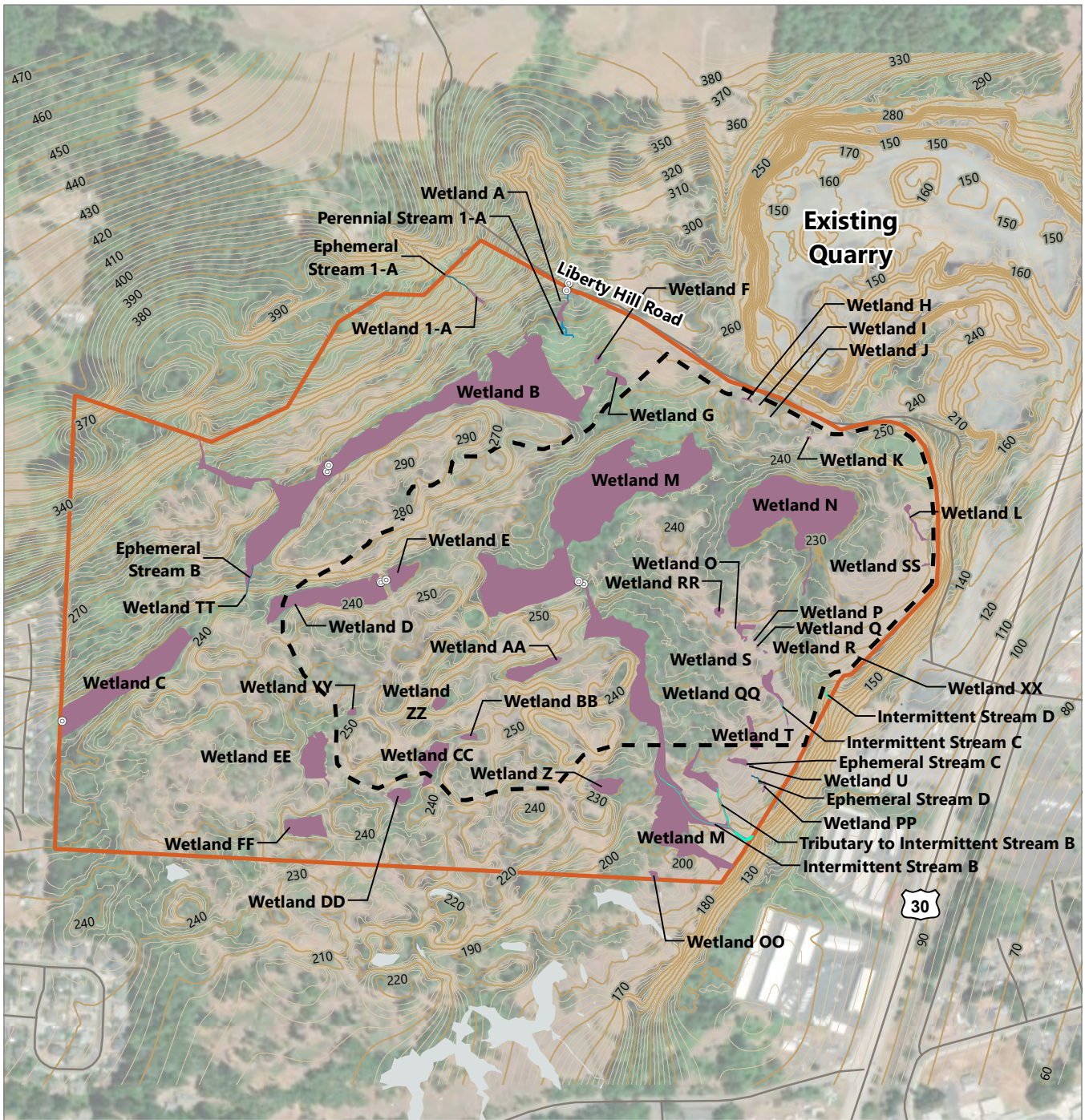


Filepath: \\fuji\Portland\Projects\Knife River Corporation\Watters Quarry NR Permitting\Deliverables\CMP\CompensatoryMitigationPlan\Figures\Figure 5 Proposed Stream Channel Design Flow Hydrographs.docx



Figure 5
Proposed Stream Channel Design Flow Hydrographs

Compensatory Mitigation Plan
Watters Quarry Phase II Project



LEGEND:

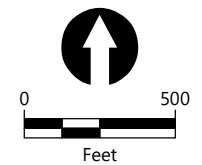
- Project Site
- Proposed Mining Area
- 10-foot Contour
- 2-foot Contour

Wetlands and Streams

- Delineated Perennial Stream
- Delineated Intermittent Stream
- Delineated Ephemeral Stream
- Delineated Wetland
- Off-site Delineated Wetlands and Streams

NOTE:

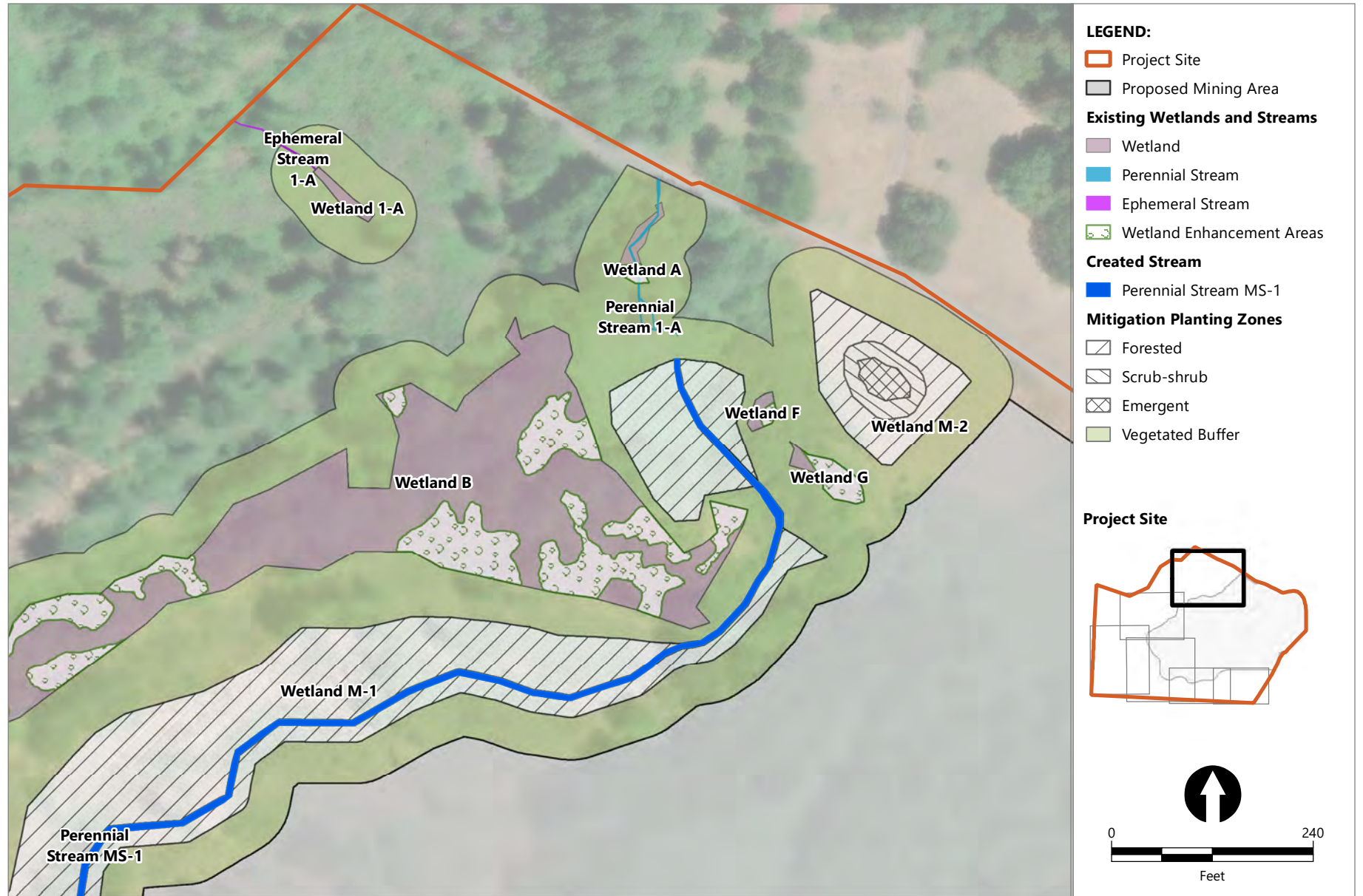
1. Aerial imagery: Esri (2021)



Publish Date: 2023/12/20, 12:11 PM | User: jfox
 Filepath: \\orcas\GIS\Jobs\Knife_River_Corp_2114\Watters_Quarry\Maps\CMP\AQ_CMP_Fig6_Wetland_Delineation_Map.mxd



Figure 6
Wetland Delineation Map
 Compensatory Mitigation Plan
 Watters Quarry Phase II Project

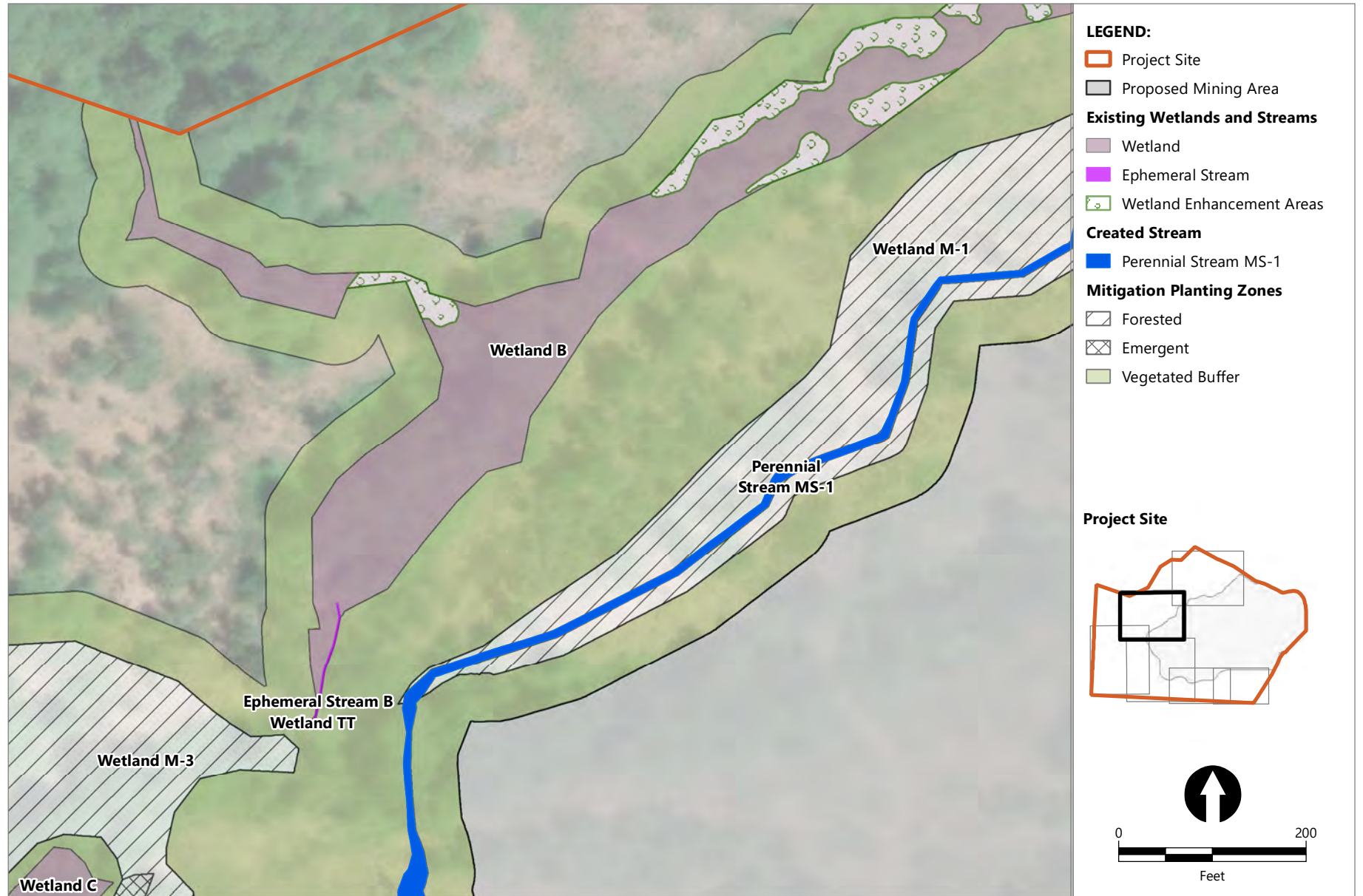


Publish Date: 2023/12/20, 12:12 PM | User: jfox
 Filepath: \\orcas\GIS\Jobs\Knife_River_Corp_2114\Watters_Quarry\Maps\CMP\AQ_CMP_Fig7_Mitigation_Planting_Zones_Map.mxd



Figure 7a
Mitigation Planting Zones

Compensatory Mitigation Plan
 Watters Quarry Phase II Project

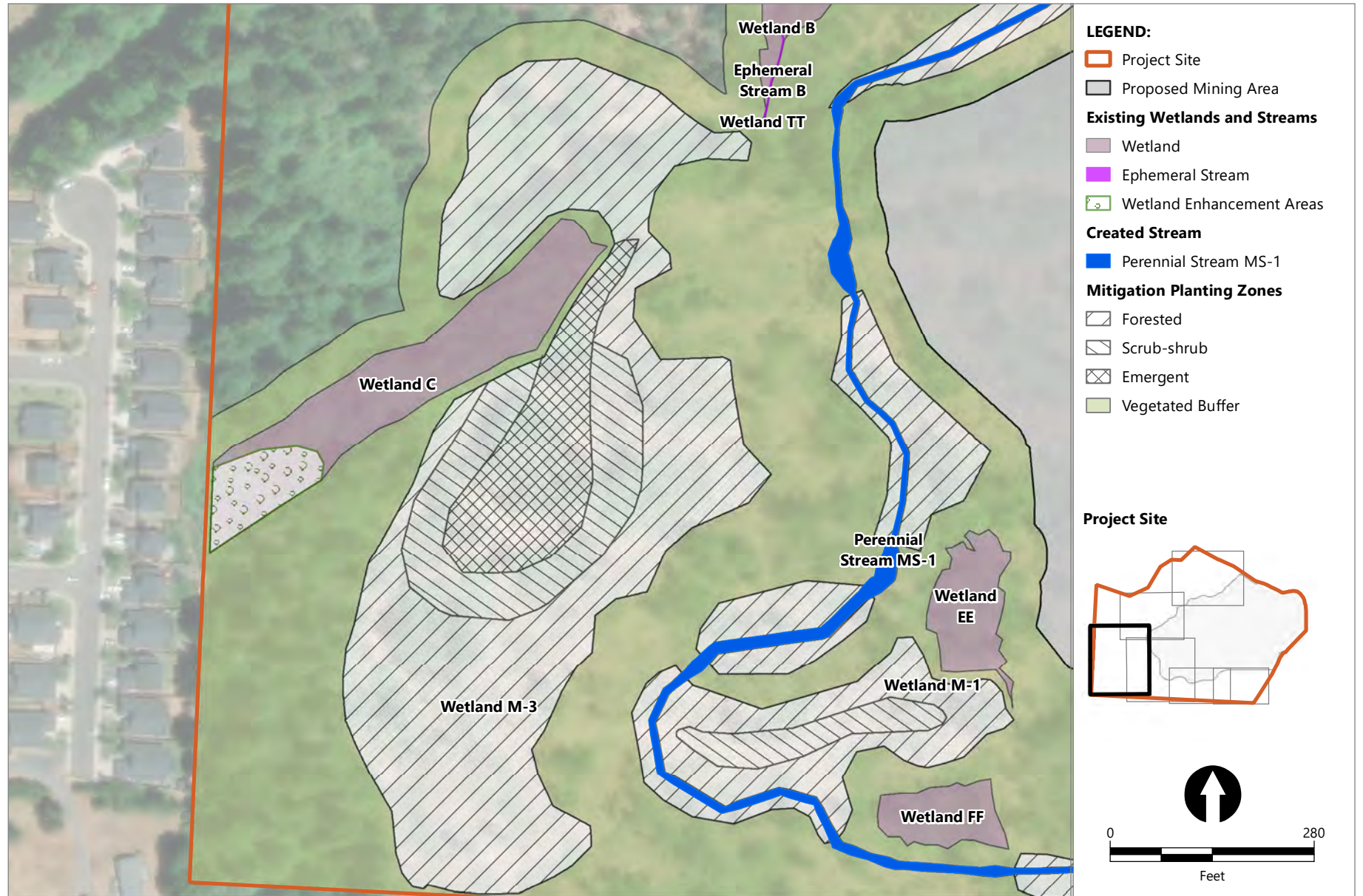


Publish Date: 2023/12/20, 12:12 PM | User: jfox
Filepath: \\orcas\GIS\Jobs\Knife_River_Corp_2114\Watters_Quarry\Maps\CMP\AQ_CMP_Fig7_Mitigation_Planting_Zones_Map.mxd



Figure 7b
Mitigation Planting Zones

Compensatory Mitigation Plan
Watters Quarry Phase II Project

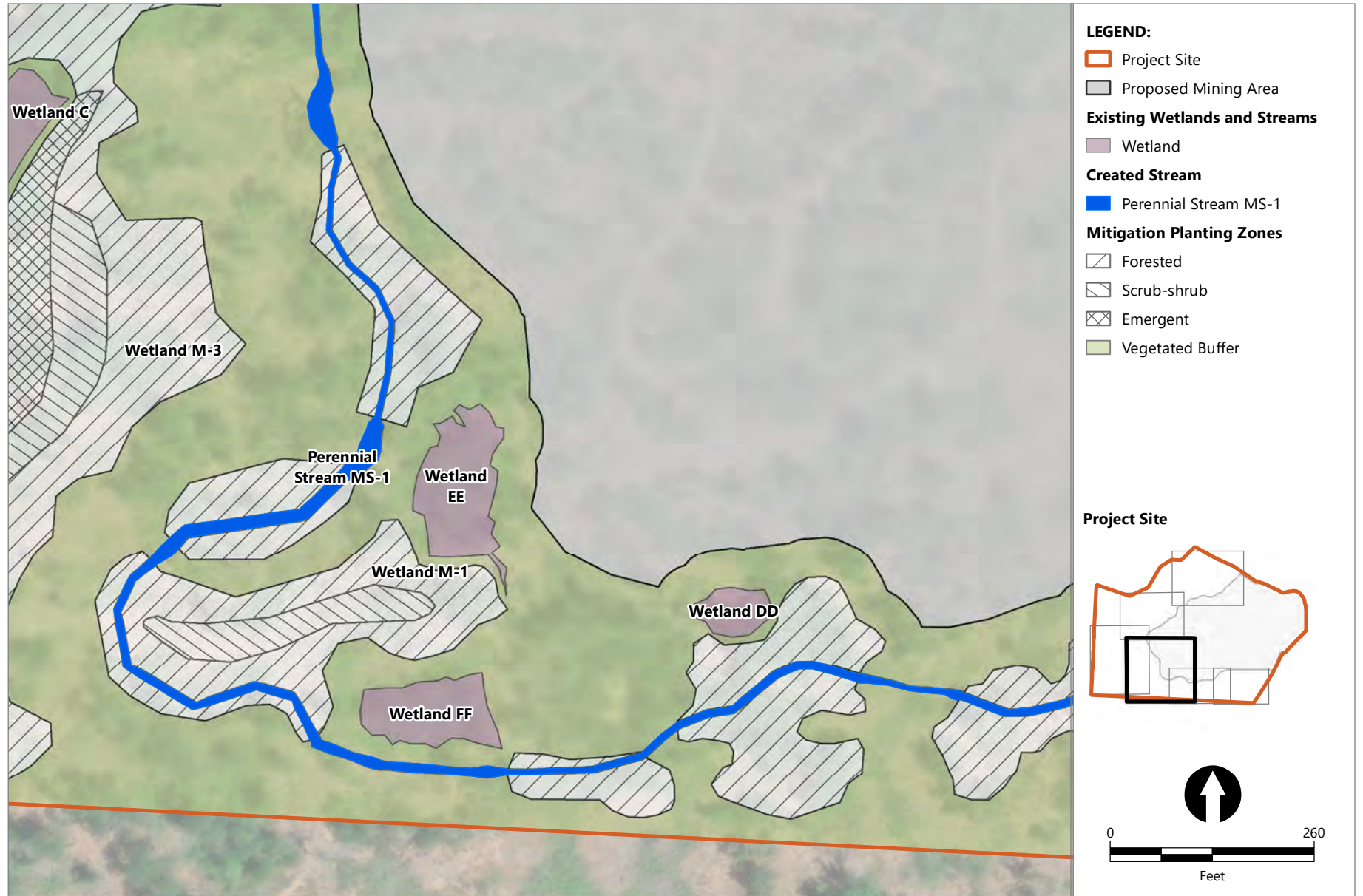


Publish Date: 2023/12/20, 12:12 PM | User: jfox
Filepath: \\orcas\GIS\Jobs\Knife_River_Corp_2114\Watters_Quarry\Maps\CMP\AQ_CMP_Fig7_Mitigation_Planting_Zones_Map.mxd



Figure 7c
Mitigation Planting Zones

Compensatory Mitigation Plan
Watters Quarry Phase II Project

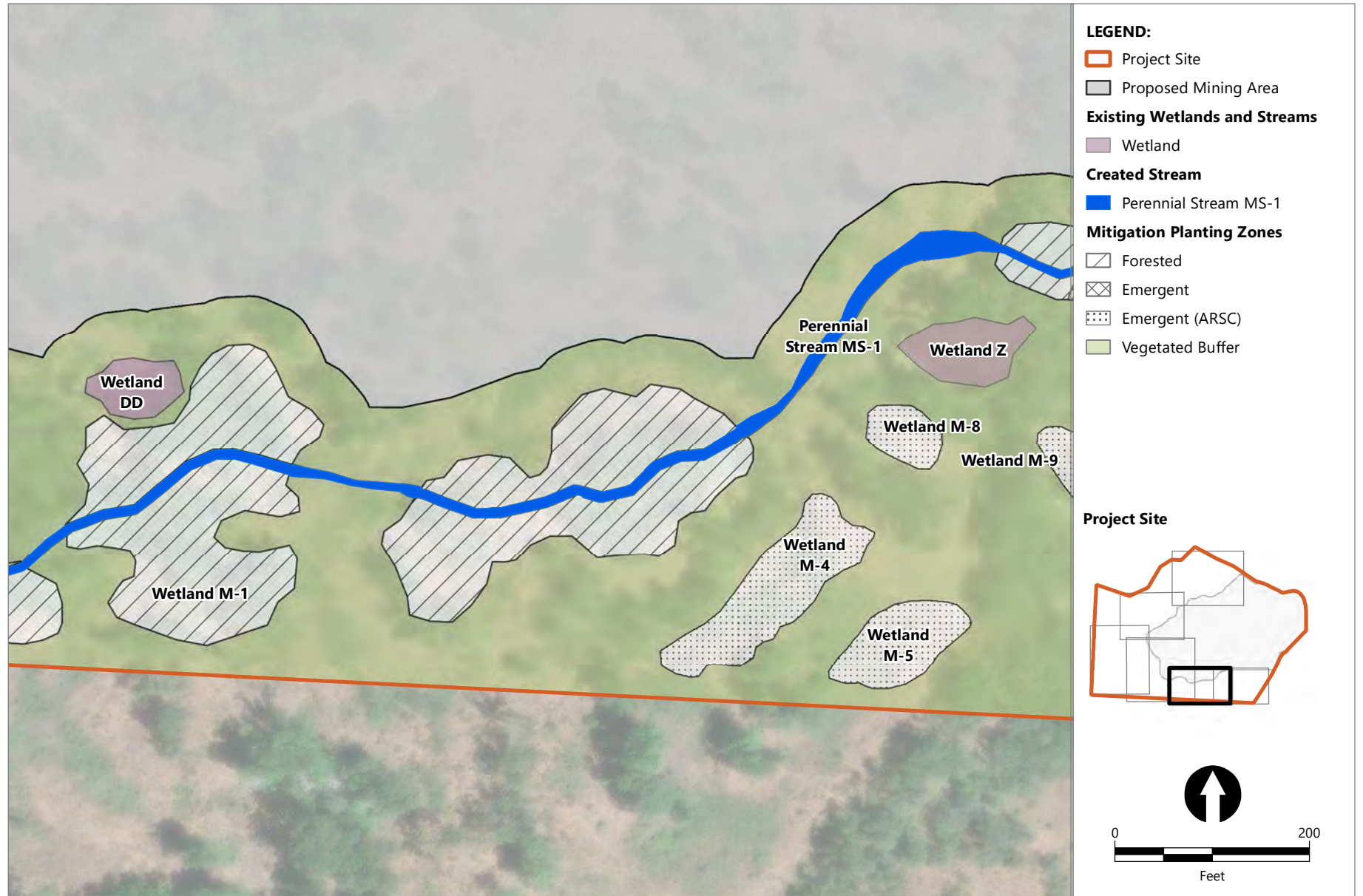


Publish Date: 2023/12/20, 12:12 PM | User: jfox
Filepath: \\orcas\GIS\Jobs\Knife_River_Corp_2114\Watters_Quarry\Maps\CMP\AQ_CMP_Fig7_Mitigation_Planting_Zones_Map.mxd



Figure 7d
Mitigation Planting Zones

Compensatory Mitigation Plan
Watters Quarry Phase II Project

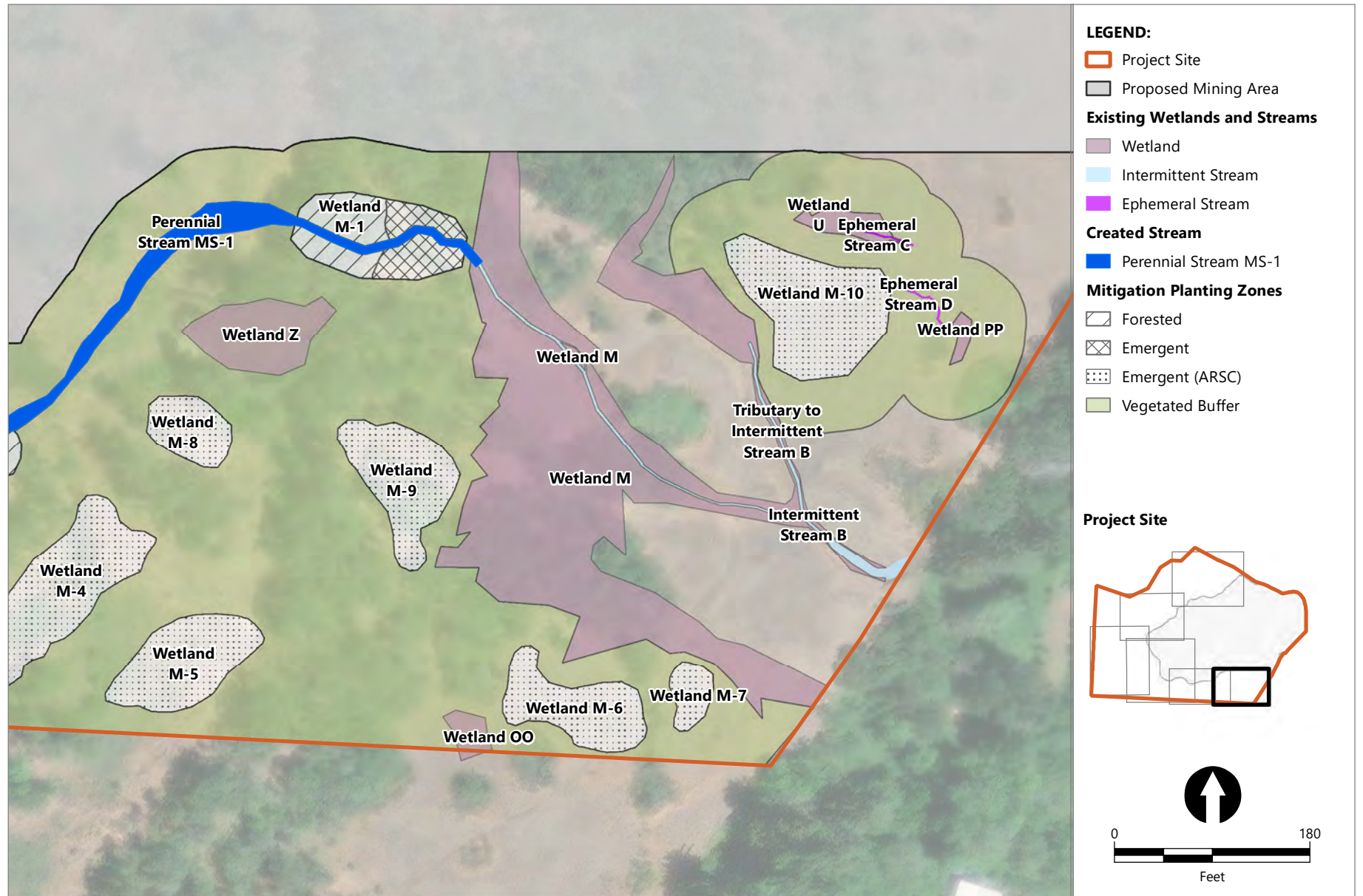


Publish Date: 2023/12/20, 12:12 PM | User: jfox
Filepath: \\orcas\GIS\Jobs\Knife_River_Corp_2114\Watters_Quarry\Maps\CMP\AQ_CMP_Fig7_Mitigation_Planting_Zones_Map.mxd



Figure 7e
Mitigation Planting Zones

Compensatory Mitigation Plan
Watters Quarry Phase II Project



Publish Date: 2023/12/20, 12:12 PM | User: jfox
 Filepath: \\orcas\GIS\Jobs\Knife_River_Corp_2114\Watters_Quarry\Maps\CMP\AQ_CMP_Fig7_Mitigation_Planting_Zones_Map.mxd



Figure 7f
Mitigation Planting Zones

Compensatory Mitigation Plan
 Watters Quarry Phase II Project



Publish Date: 2023/12/20, 12:23 PM | User: jfox
Filepath: \\orcas\GIS\Jobs\Knife_River_Corp_2114\Watters_Quarry\Maps\CMP\2023\AQ_WattersQuarry_CMP_Fig8_HabitatType.mxd



Figure 8
Habitat Mapping
Compensatory Mitigation Plan
Watters Quarry Phase II Project

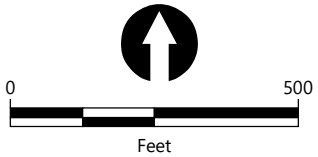


LEGEND:

- Project Site
- Proposed Mining Area

NOTES:

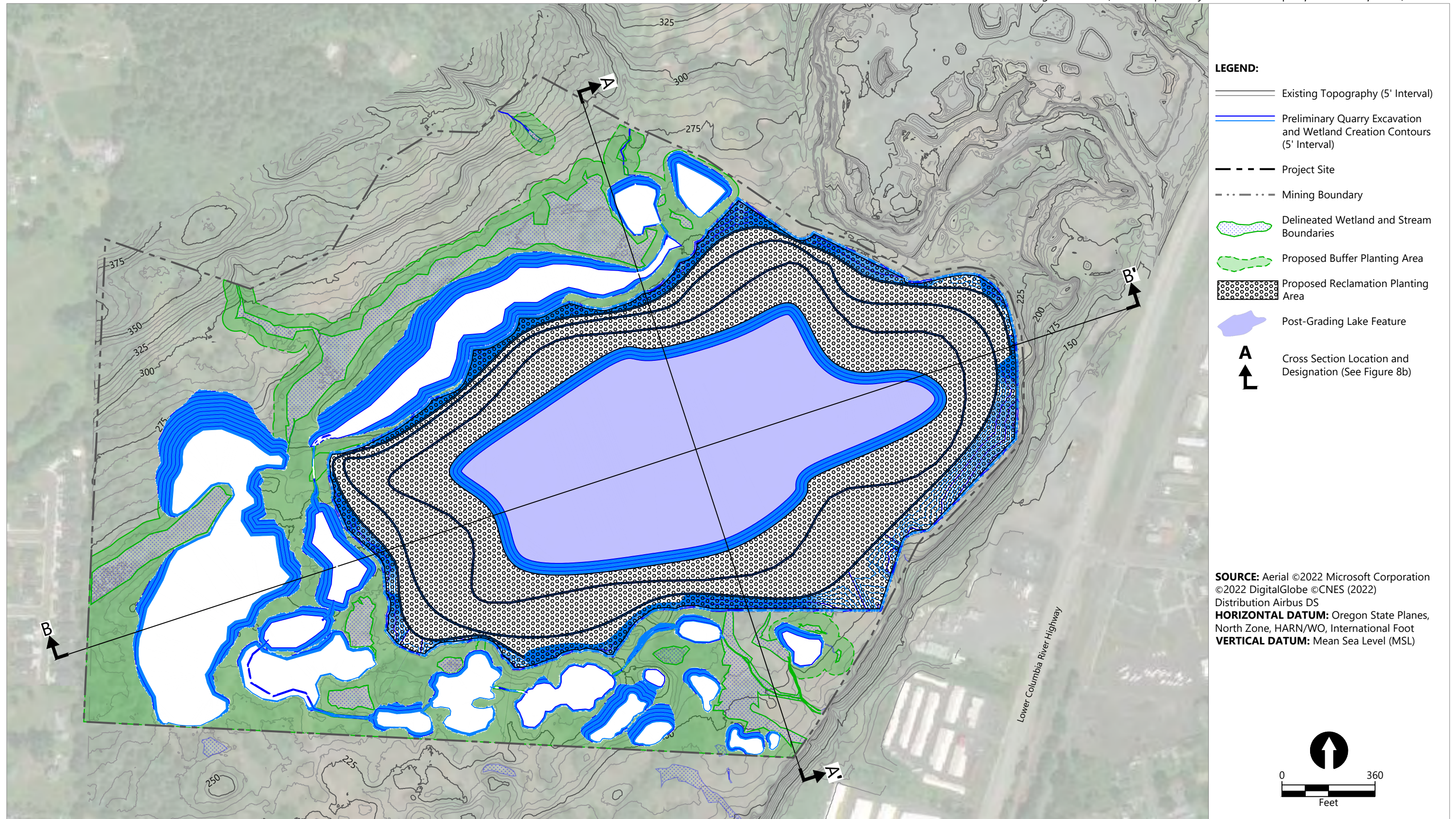
- 1. Aerial Imagery from NAIP, 2014
- NAIP: National Agriculture Imagery Program



Publish Date: 2023/12/20, 12:23 PM | User: jfox
 Filepath: \\orcas\GIS\Jobs\Knife_River_Corp_2114\Watters_Quarry\Maps\CMP\2023\AQ_WattersQuarry_CMP_Fig9_Pre-LoggingImagery.mxd

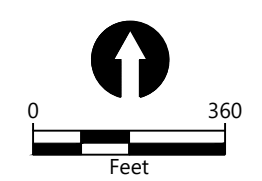


Figure 9
2014 NAIP Imagery
 Compensatory Mitigation Plan
 Watters Quarry Phase II Project



- LEGEND:**
- Existing Topography (5' Interval)
 - Preliminary Quarry Excavation and Wetland Creation Contours (5' Interval)
 - Project Site
 - Mining Boundary
 - Delineated Wetland and Stream Boundaries
 - Proposed Buffer Planting Area
 - Proposed Reclamation Planting Area
 - Post-Grading Lake Feature
 - A**
Cross Section Location and Designation (See Figure 8b)

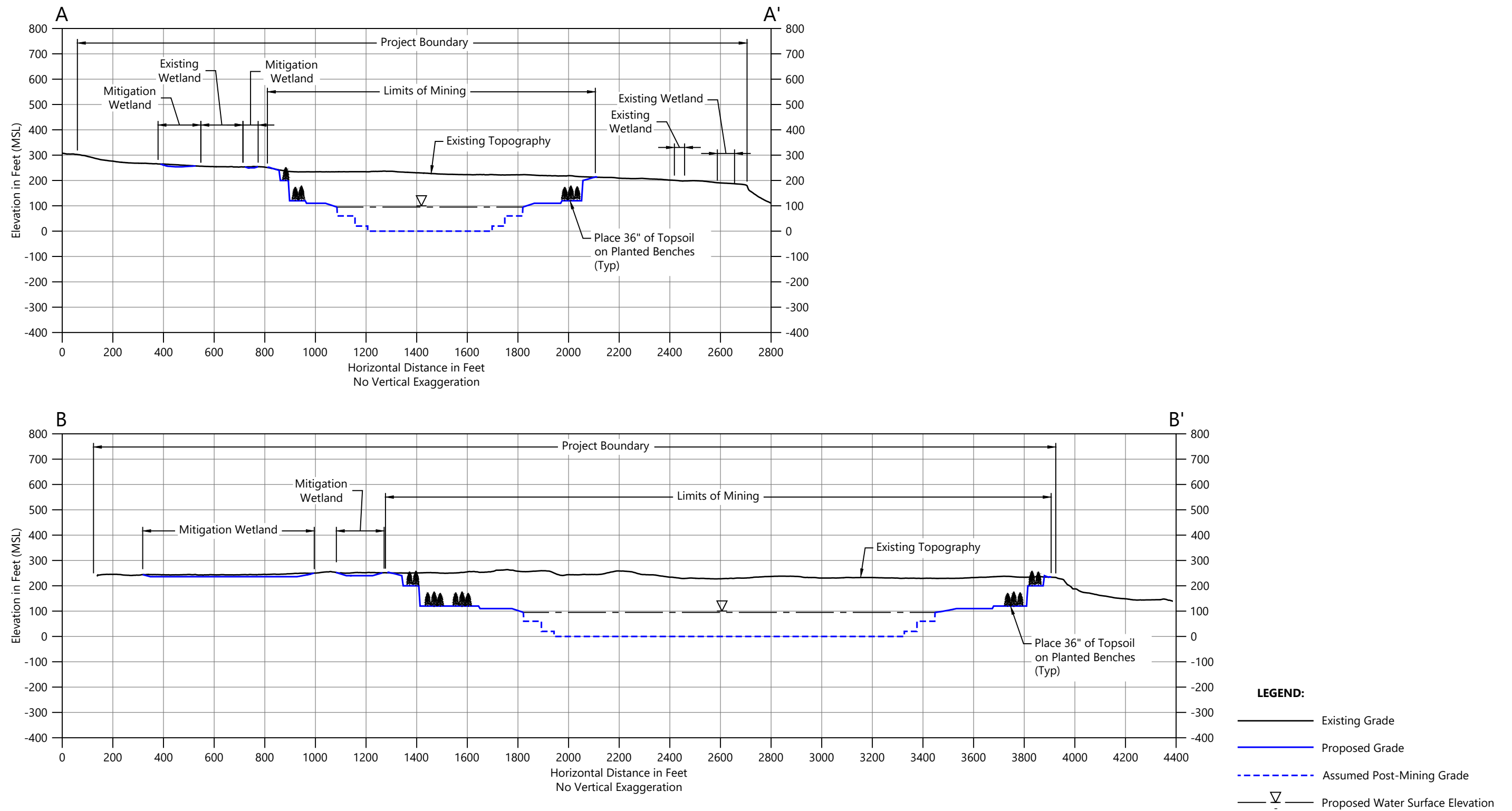
SOURCE: Aerial ©2022 Microsoft Corporation ©2022 DigitalGlobe ©CNES (2022) Distribution Airbus DS
HORIZONTAL DATUM: Oregon State Planes, North Zone, HARN/WO, International Foot
VERTICAL DATUM: Mean Sea Level (MSL)



Publish Date: 2023/11/30 1:06 PM | User: chewett
 Filepath: K:\Projects\2114-Knife River Corporation-NW\Watters Quarry Expansion\2114-RP-005 (Preliminary Mining Plan).dwg Figure 10a



Figure 10a
Phase II Reclamation Plan
 Compensatory Mitigation Plan
 Watters Quarry Phase II Project



Publish Date: 2023/11/30 1:06 PM | User: chewett
 Filepath: K:\Projects\2114-Knife River Corporation-NW\Watters Quarry Expansion\2114-RP-005 (Preliminary Mining Plan).dwg Figure 10b

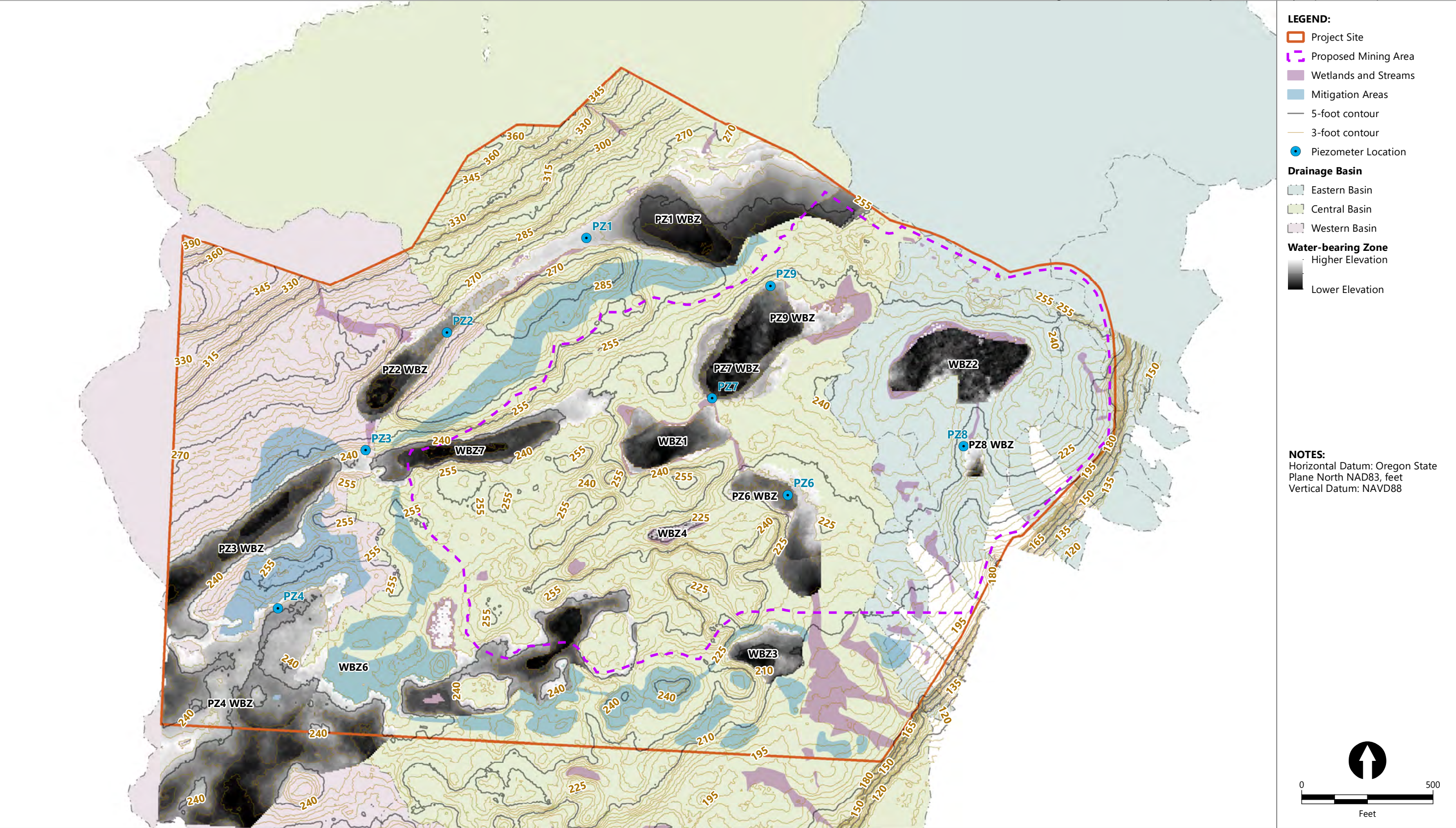


Figure 10b
Phase II Reclamation Plan Cross Sections A-A' and B-B'

Compensatory Mitigation Plan
 Watters Quarry Phase II Project

Appendix A

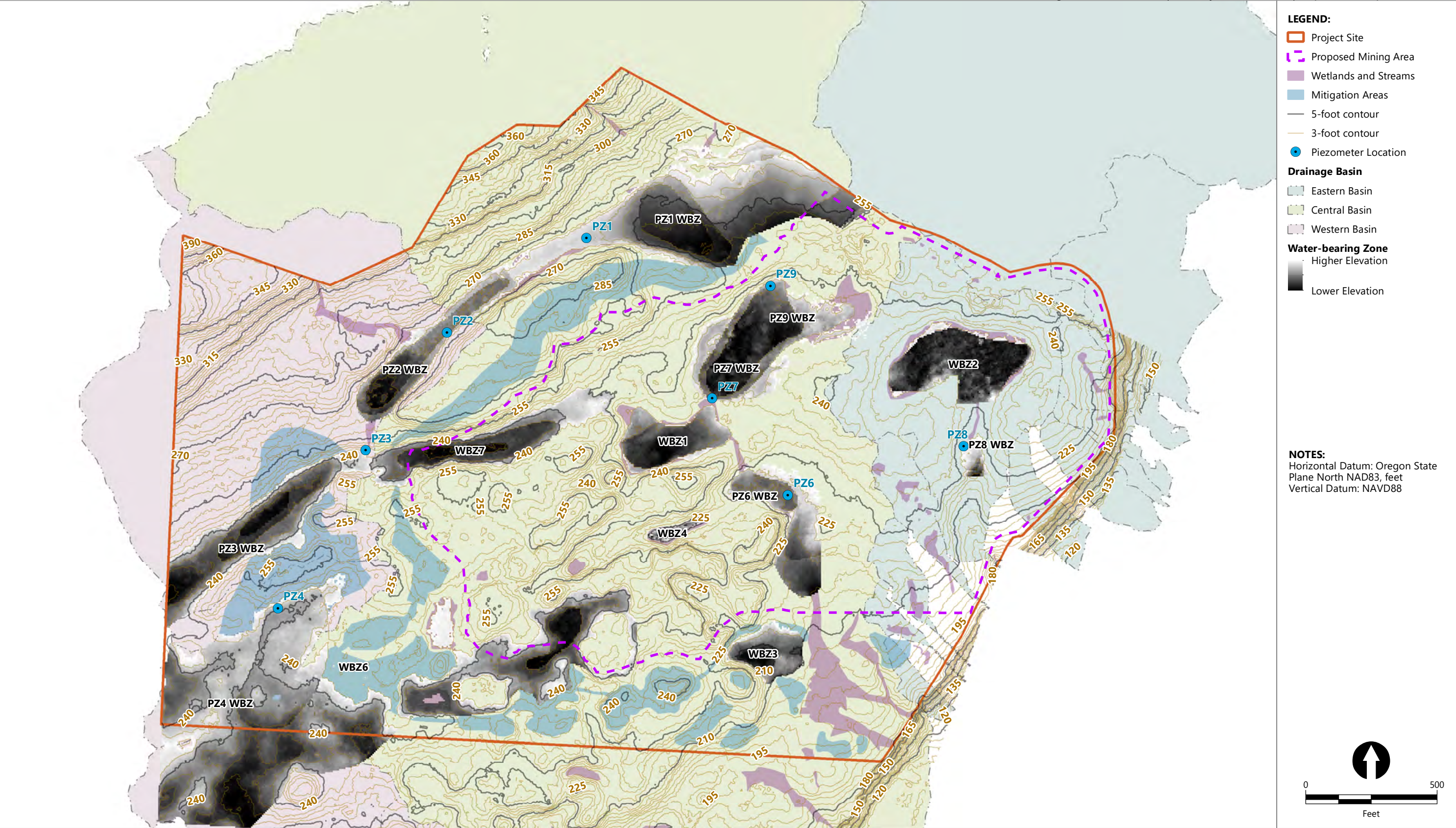
Groundwater Elevation Maps



Publish Date: 2023/12/28, 11:18 AM | User: jfox
Filepath: \\orcas\GIS\Jobs\Knife_River_Corp_2114\Watters_Quarry\Maps\GroundwaterHydrology\AQ_WattersQuarry_GW_Analysis_Map_2020June.mxd



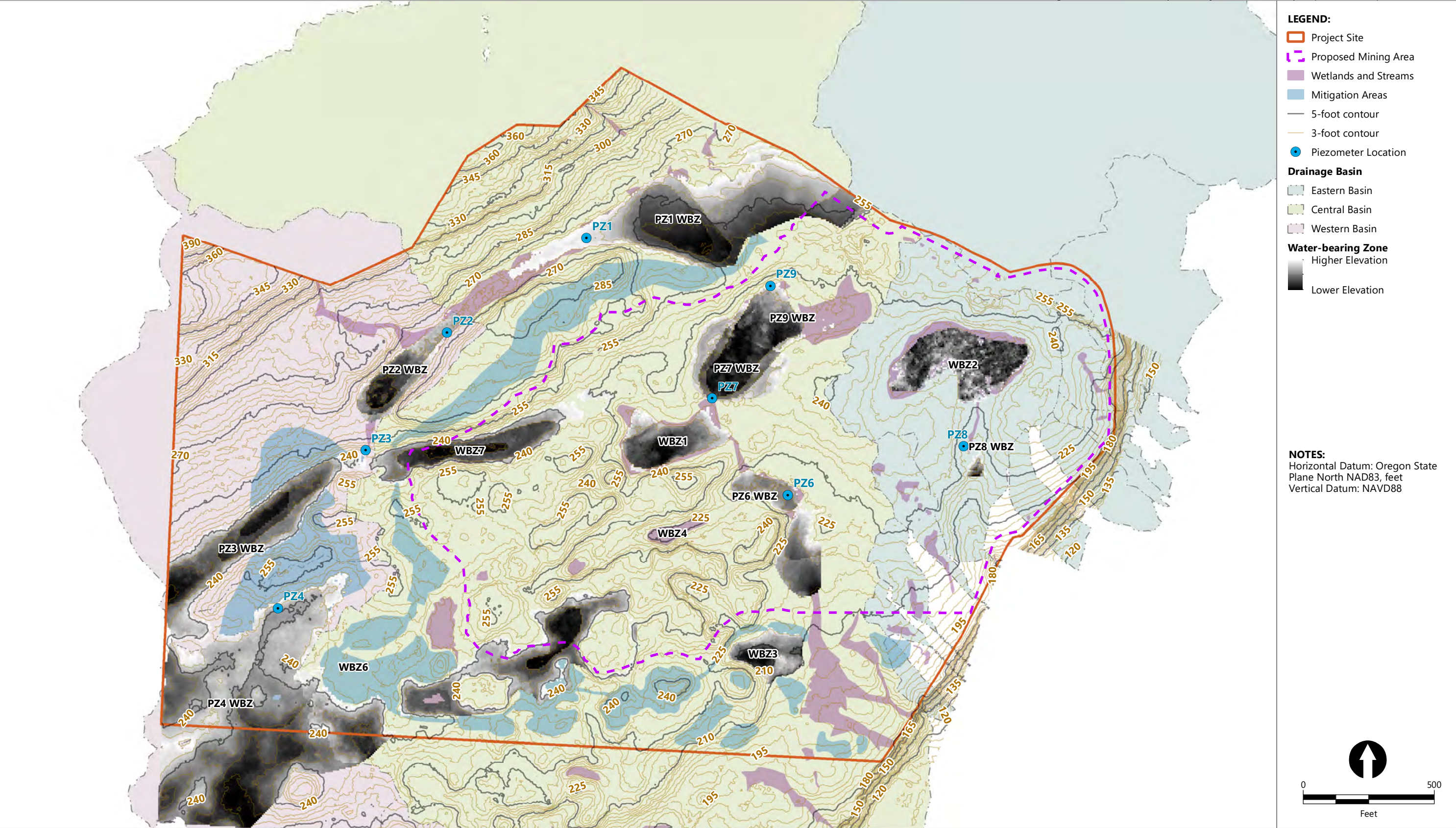
Figure A-1
June 1, 2020 Groundwater Elevation Map
 Watters Quarry Phase II Project



Publish Date: 2023/12/28, 11:06 AM | User: jfox
Filepath: \\orcas\GIS\Jobs\Knife_River_Corp_2114\Watters_Quarry\Maps\GroundwaterHydrology\AQ_WattersQuarry_GW_Analysis_Map_2020July.mxd



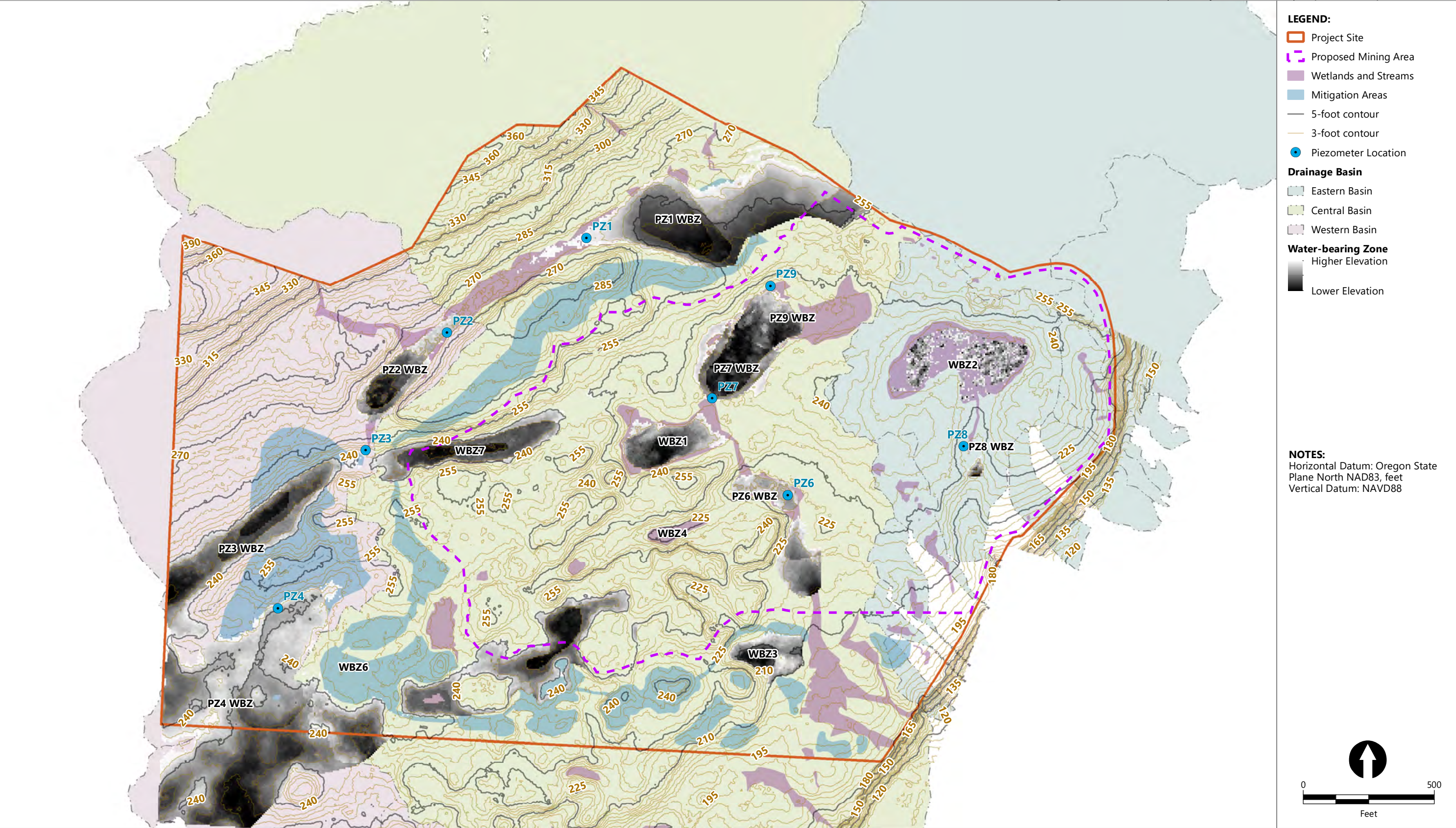
Figure A-2
July 1, 2020 Groundwater Elevation Map
 Watters Quarry Phase II Project



Publish Date: 2023/12/28, 11:08 AM | User: jfox
Filepath: \\orcas\GIS\Jobs\Knife_River_Corp_2114\Watters_Quarry\Maps\GroundwaterHydrology\AQ_WattersQuarry_GW_Analysis_Map_2020August.mxd



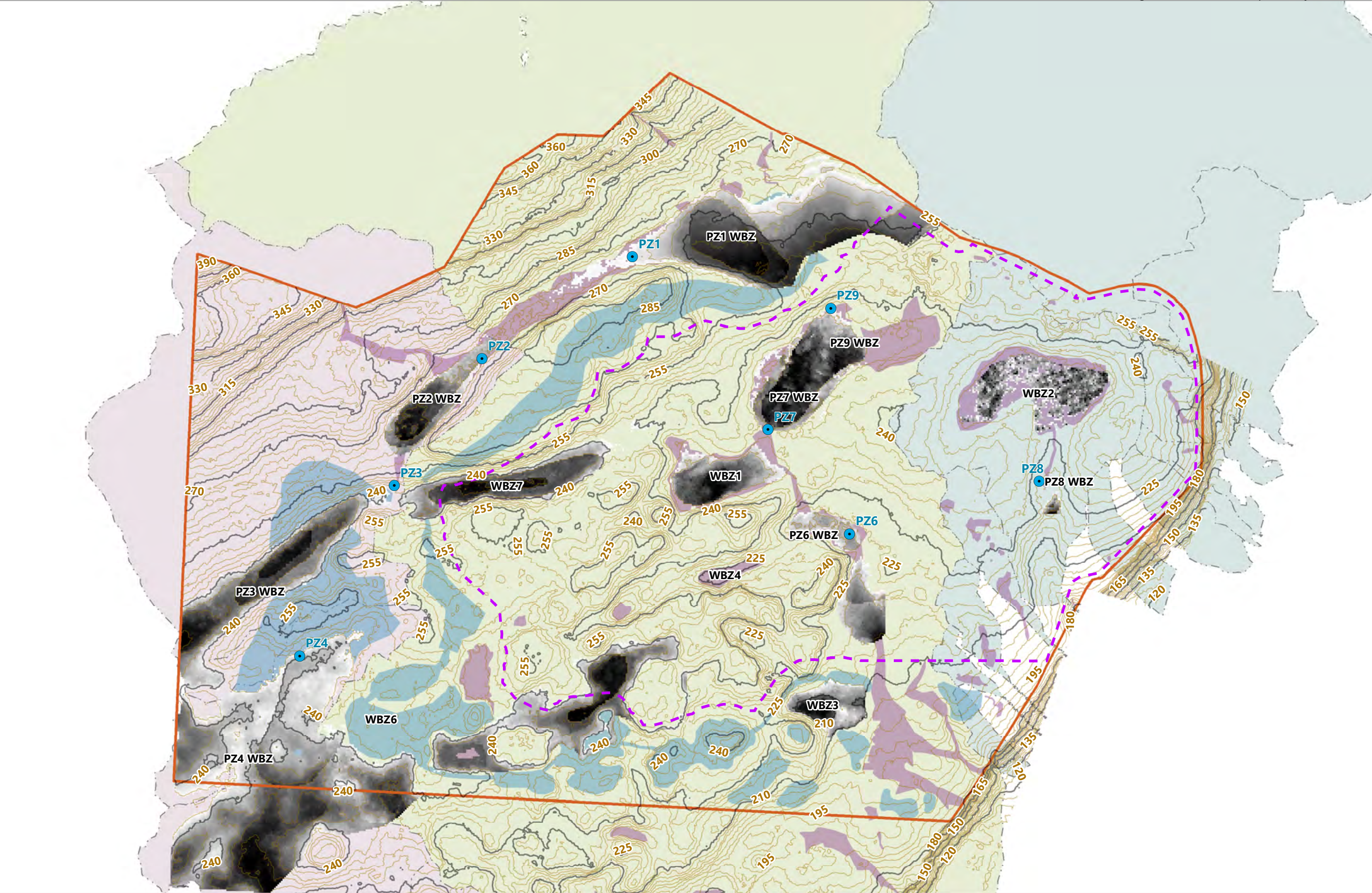
Figure A-3
August 1, 2020 Groundwater Elevation Map
 Watters Quarry Phase II Project



Publish Date: 2023/12/28, 11:10 AM | User: jfox
Filepath: \\orcas\GIS\Jobs\Knife_River_Corp_2114\Watters_Quarry\Maps\GroundwaterHydrology\AQ_WattersQuarry_GW_Analysis_Map_2020September.mxd



Figure A-4
September 1, 2020 Groundwater Elevation Map
 Watters Quarry Phase II Project



LEGEND:

- Project Site
- Proposed Mining Area
- Wetlands and Streams
- Mitigation Areas
- 5-foot contour
- 3-foot contour
- Piezometer Location

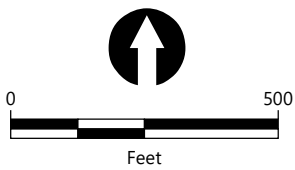
Drainage Basin

- Eastern Basin
- Central Basin
- Western Basin

Water-bearing Zone

- Higher Elevation
- Lower Elevation

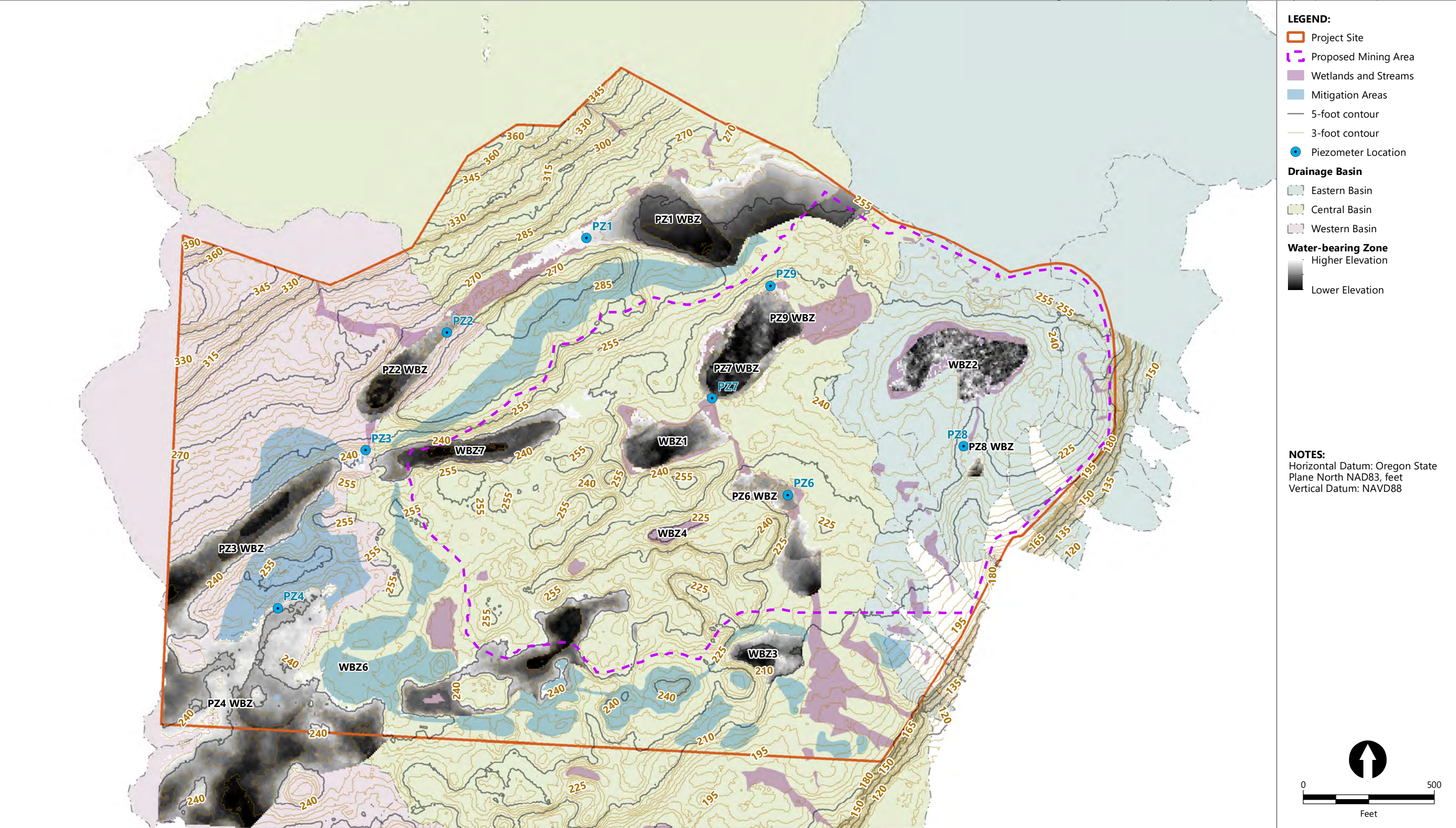
NOTES:
 Horizontal Datum: Oregon State Plane North NAD83, feet
 Vertical Datum: NAVD88



Publish Date: 2023/12/28, 11:12 AM | User: jfox
 Filepath: \\orcas\GIS\Jobs\Knife_River_Corp_2114\Watters_Quarry\Maps\GroundwaterHydrology\AQ_WattersQuarry_GW_Analysis_Map_2020October.mxd



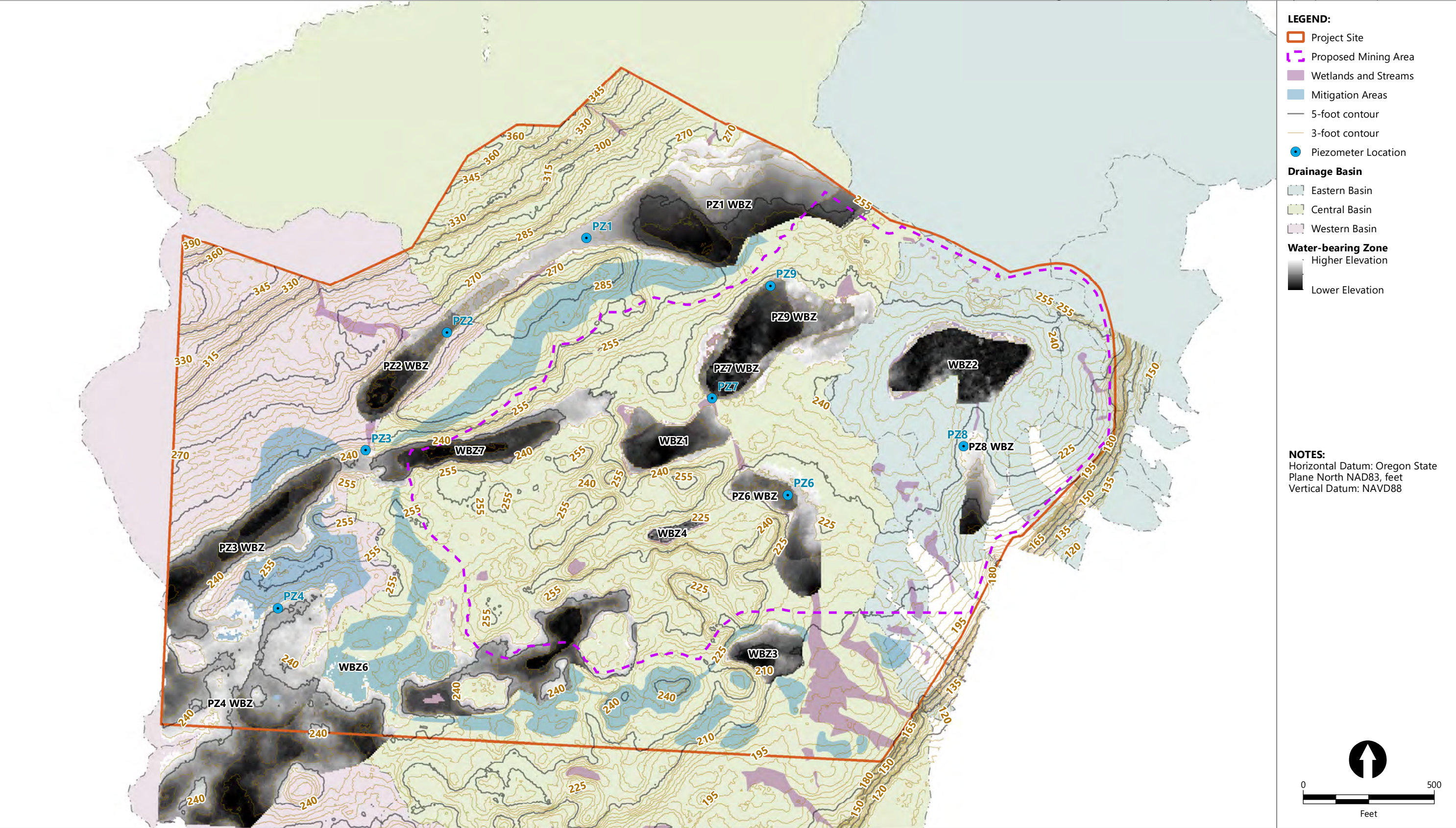
Figure A-5
October 1, 2020 Groundwater Elevation Map
 Watters Quarry Phase II Project



Publish Date: 2023/12/28, 11:14 AM | User: jfox
Filepath: \\orcas\GIS\Jobs\Knife_River_Corp_2114\Watters_Quarry\Maps\GroundwaterHydrology\AQ_WattersQuarry_GW_Analysis_Map_2020November.mxd



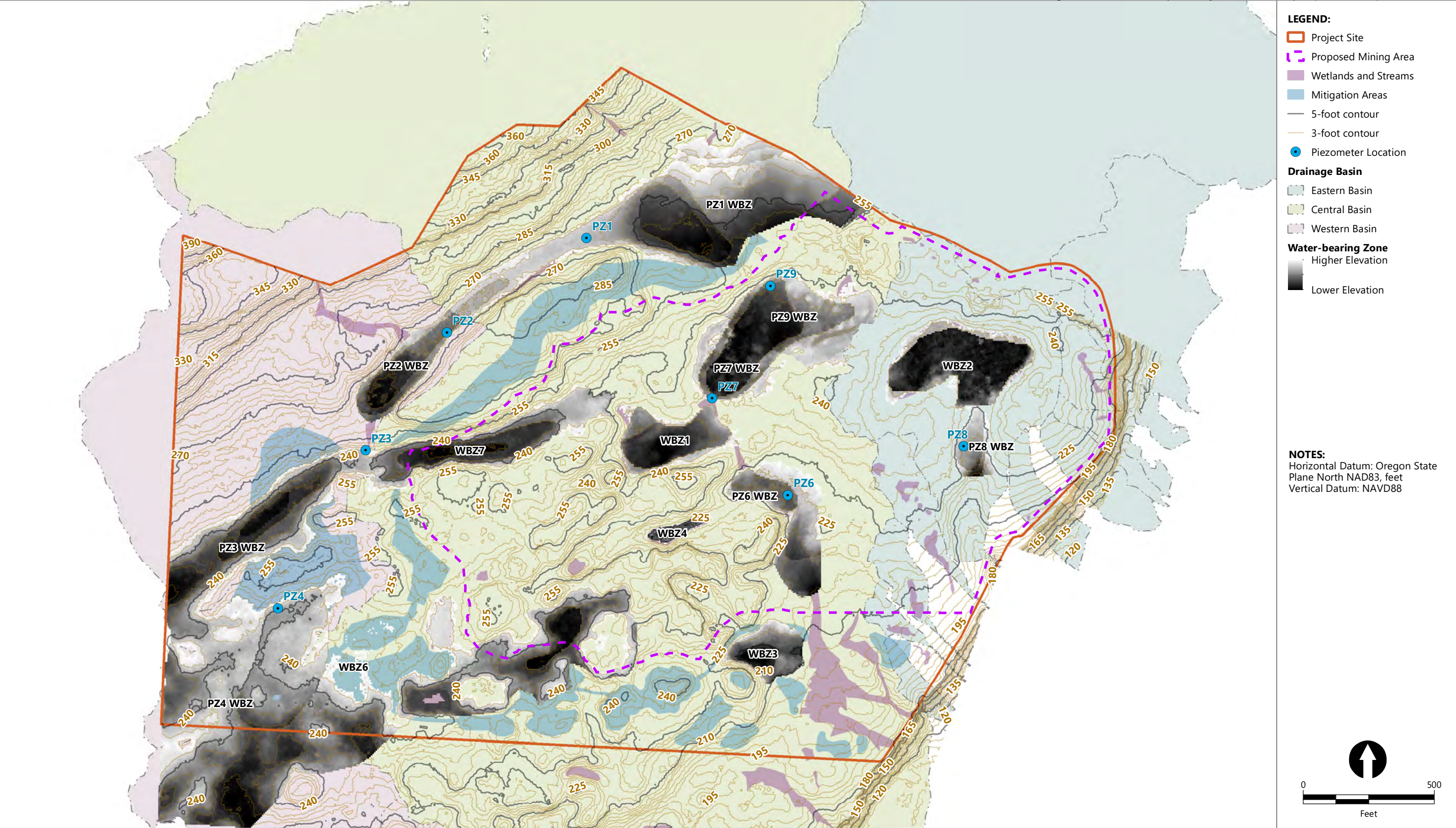
Figure A-6
November 1, 2020 Groundwater Elevation Map
 Watters Quarry Phase II Project



Publish Date: 2023/12/28, 11:21 AM | User: jfox
Filepath: \\orcas\GIS\Jobs\Knife_River_Corp_2114\Watters_Quarry\Maps\GroundwaterHydrology\AQ_WattersQuarry_GW_Analysis_Map_2020December.mxd



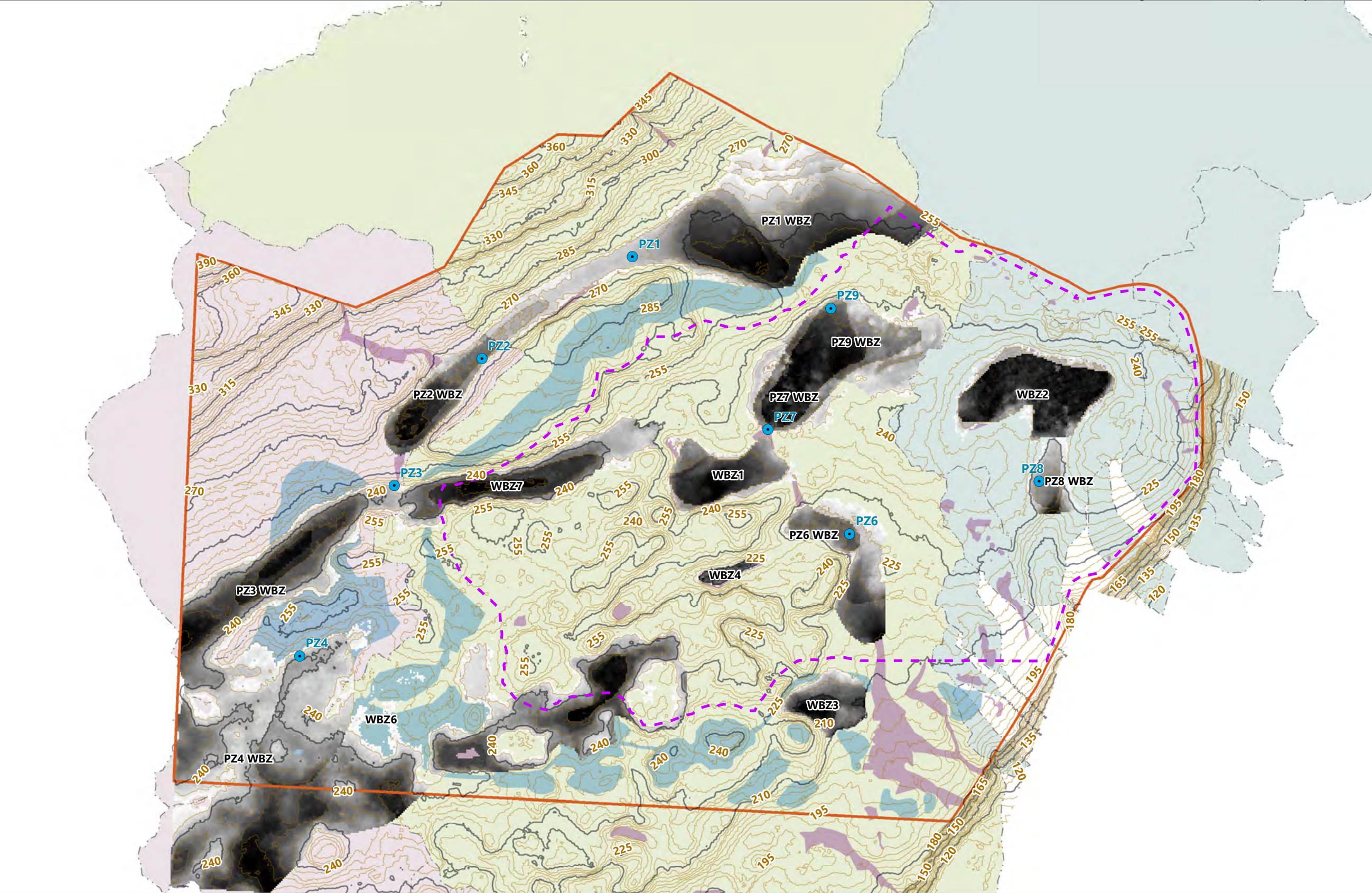
Figure A-7
December 1, 2020 Groundwater Elevation Map
 Watters Quarry Phase II Project



Publish Date: 2023/12/28, 11:23 AM | User: jfox
Filepath: \\orcas\GIS\Jobs\Knife_River_Corp_2114\Watters_Quarry\Maps\GroundwaterHydrology\AQ_WattersQuarry_GW_Analysis_Map_2021January.mxd



Figure A-8
January 1, 2021 Groundwater Elevation Map
 Watters Quarry Phase II Project



LEGEND:

- Project Site
- Proposed Mining Area
- Wetlands and Streams
- Mitigation Areas
- 5-foot contour
- 3-foot contour
- Piezometer Location

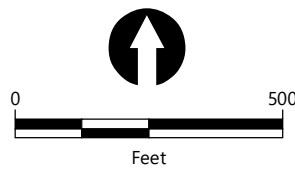
Drainage Basin

- Eastern Basin
- Central Basin
- Western Basin

Water-bearing Zone

- Higher Elevation
- Lower Elevation

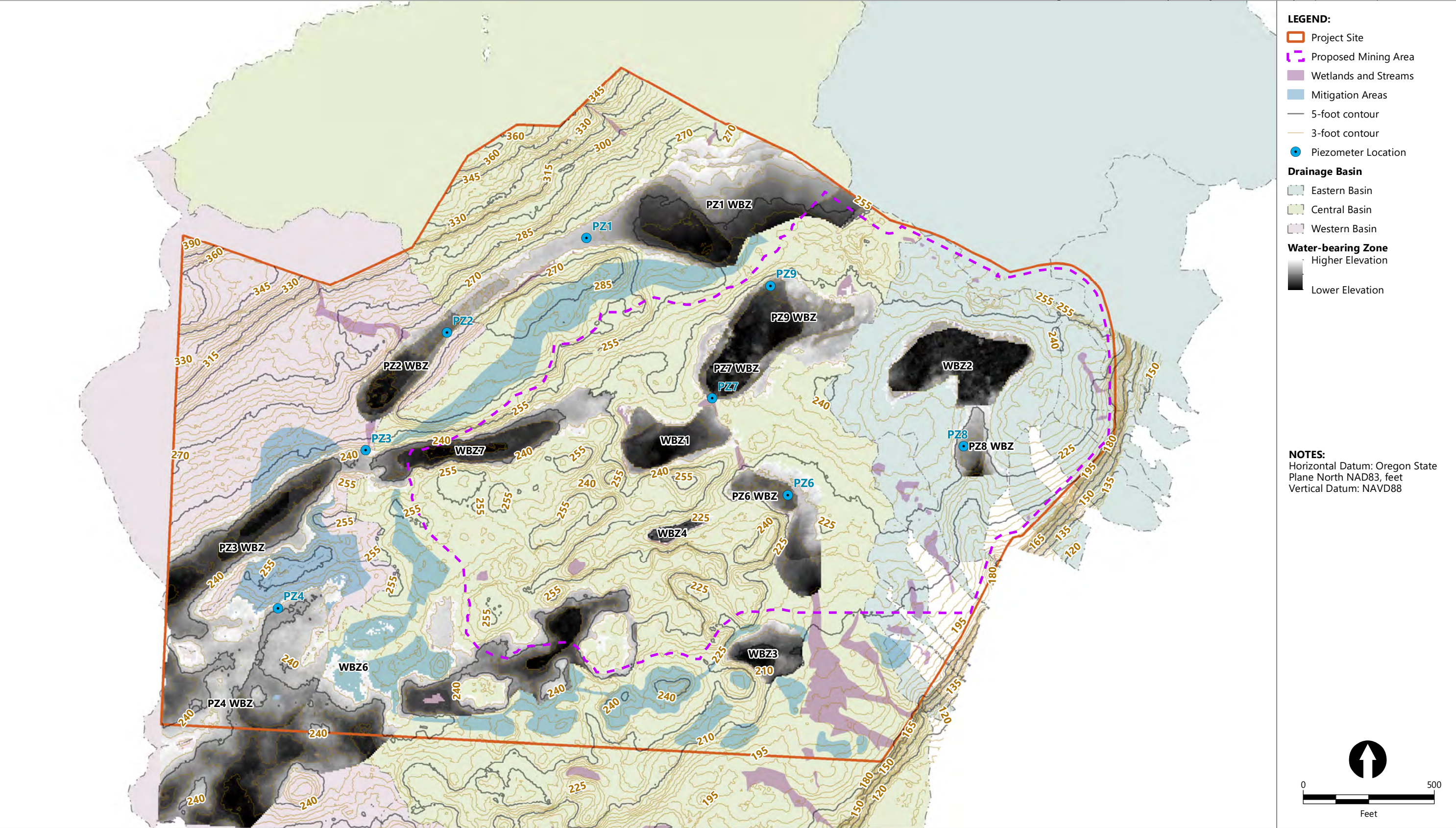
NOTES:
 Horizontal Datum: Oregon State Plane North NAD83, feet
 Vertical Datum: NAVD88



Publish Date: 2023/12/28, 11:25 AM | User: jfox
 Filepath: \\orcas\GIS\Jobs\Knife_River_Corp_2114\Watters_Quarry\Maps\GroundwaterHydrology\AQ_WattersQuarry_GW_Analysis_Map_2021February.mxd



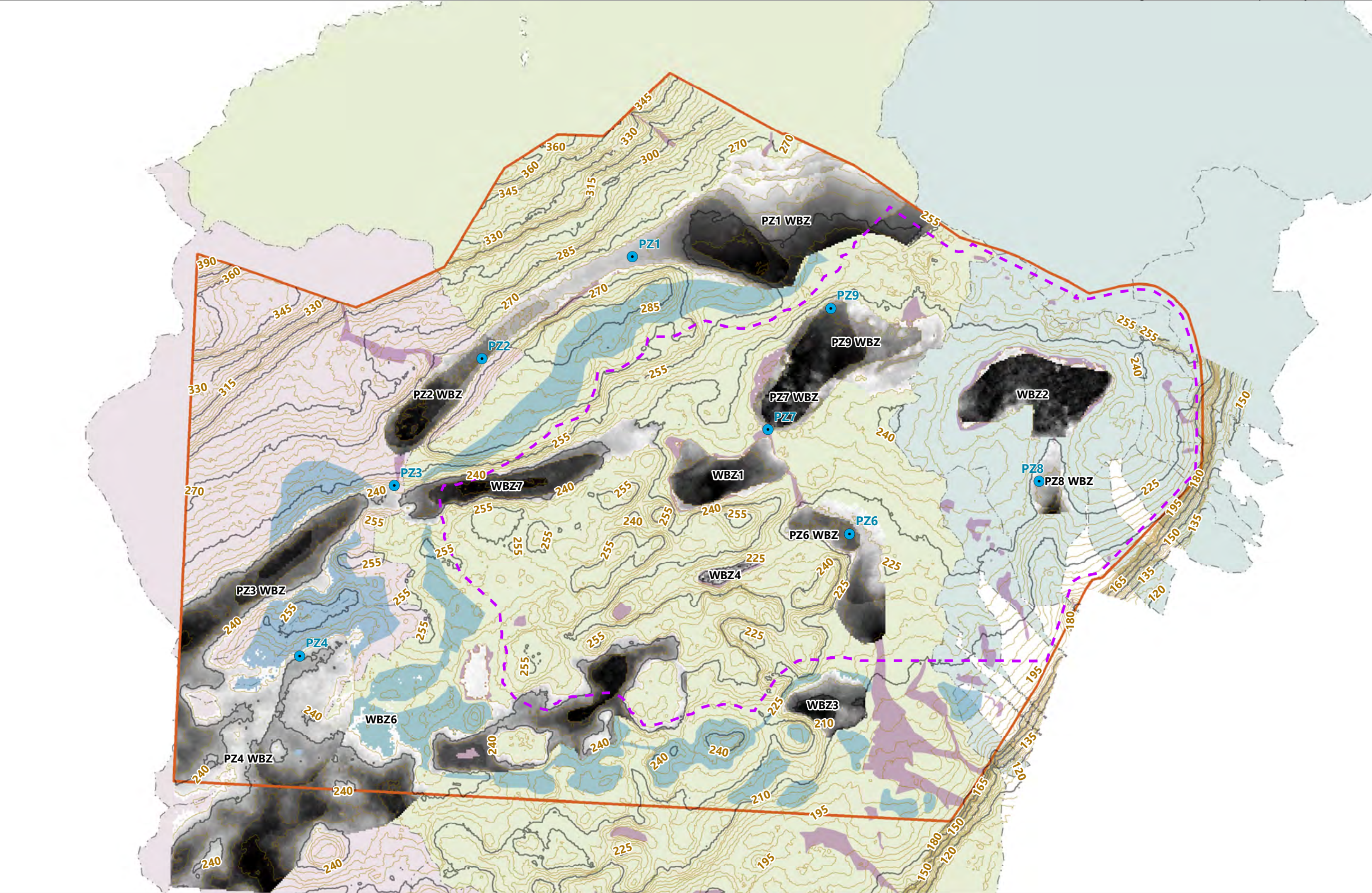
Figure A-9
February 1, 2021 Groundwater Elevation Map
 Watters Quarry Phase II Project



Publish Date: 2023/12/28, 11:27 AM | User: jfox
Filepath: \\orcas\GIS\Jobs\Knife_River_Corp_2114\Watters_Quarry\Maps\GroundwaterHydrology\AQ_WattersQuarry_GW_Analysis_Map_2021March.mxd



Figure A-10
March 1, 2021 Groundwater Elevation Map
 Watters Quarry Phase II Project



LEGEND:

- Project Site
- Proposed Mining Area
- Wetlands and Streams
- Mitigation Areas
- 5-foot contour
- 3-foot contour
- Piezometer Location

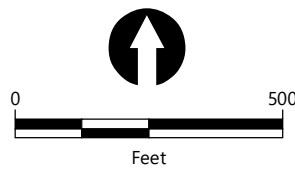
Drainage Basin

- Eastern Basin
- Central Basin
- Western Basin

Water-bearing Zone

- Higher Elevation
- Lower Elevation

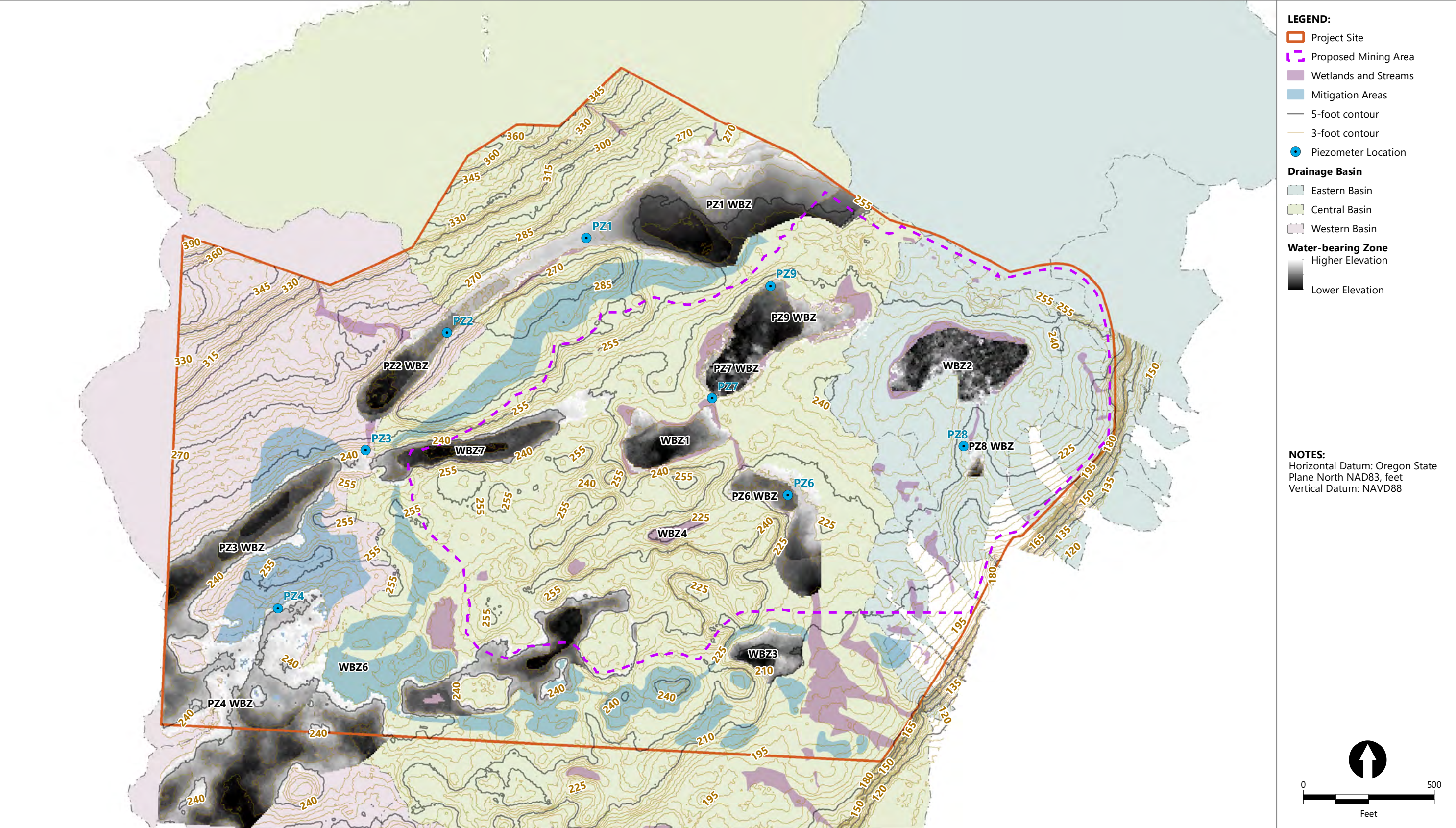
NOTES:
 Horizontal Datum: Oregon State Plane North NAD83, feet
 Vertical Datum: NAVD88



Publish Date: 2023/12/28, 11:29 AM | User: jfox
 Filepath: \\orcas\GIS\Jobs\Knife_River_Corp_2114\Watters_Quarry\Maps\GroundwaterHydrology\AQ_WattersQuarry_GW_Analysis_Map_2021April.mxd



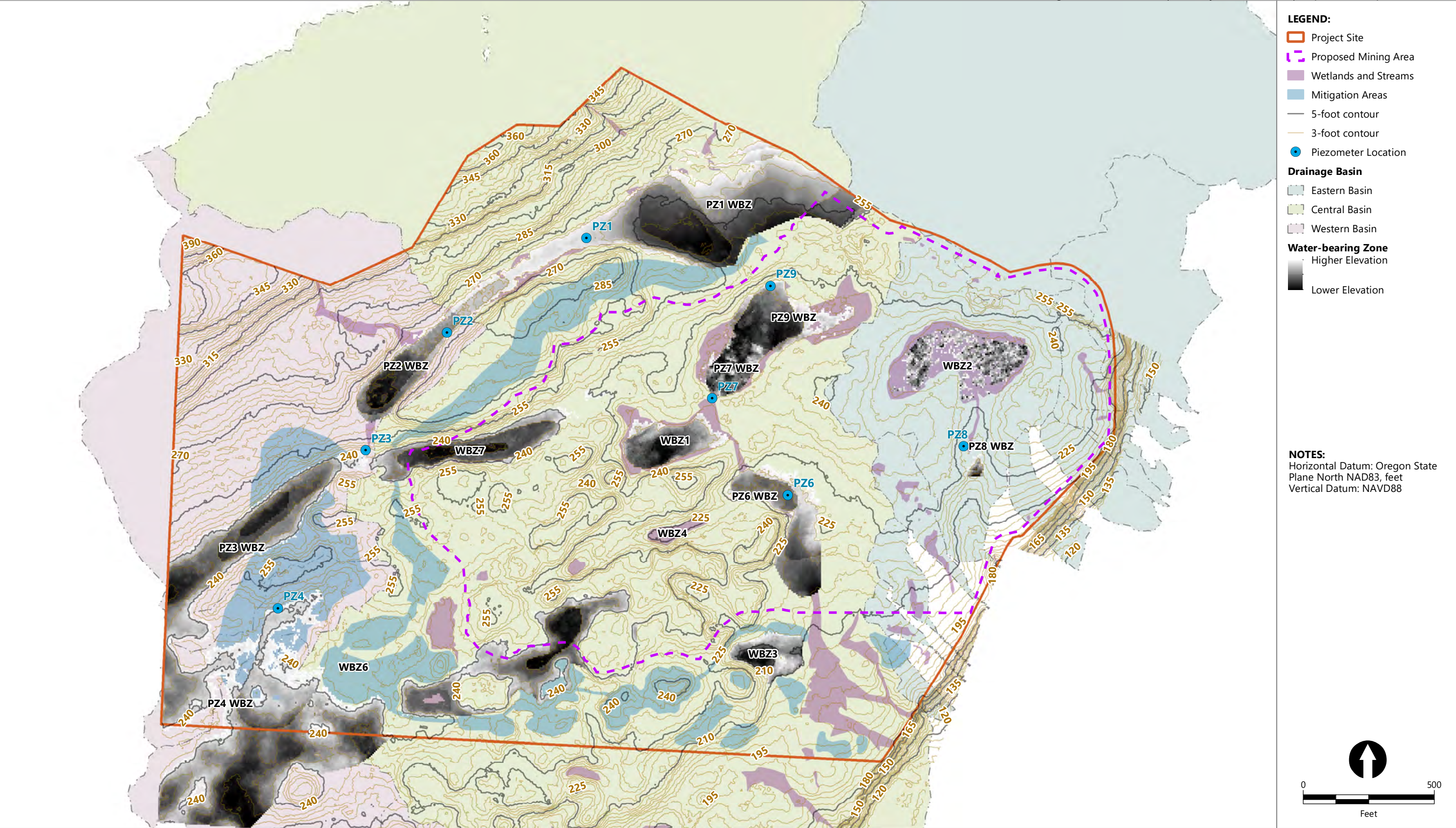
Figure A-11
April 1, 2021 Groundwater Elevation Map
 Watters Quarry Phase II Project



Publish Date: 2023/12/28, 11:31 AM | User: jfox
Filepath: \\orcas\GIS\Jobs\Knife_River_Corp_2114\Watters_Quarry\Maps\GroundwaterHydrology\AQ_WattersQuarry_GW_Analysis_Map_2021May.mxd



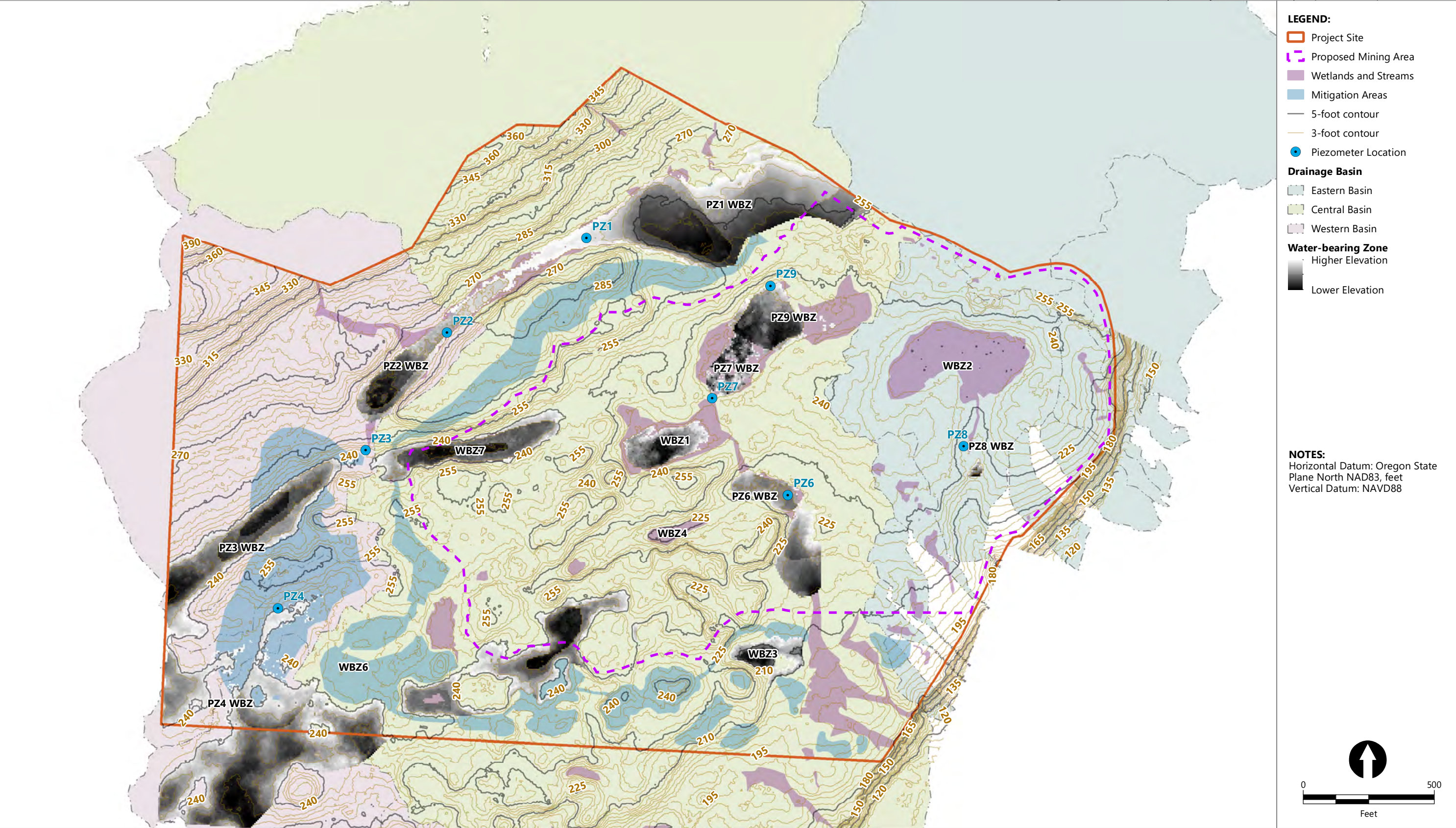
Figure A-12
May 1, 2021 Groundwater Elevation Map
Watters Quarry Phase II Project



Publish Date: 2023/12/28, 11:33 AM | User: jfox
Filepath: \\orcas\GIS\Jobs\Knife_River_Corp_2114\Watters_Quarry\Maps\GroundwaterHydrology\AQ_WattersQuarry_GW_Analysis_Map_2021June.mxd



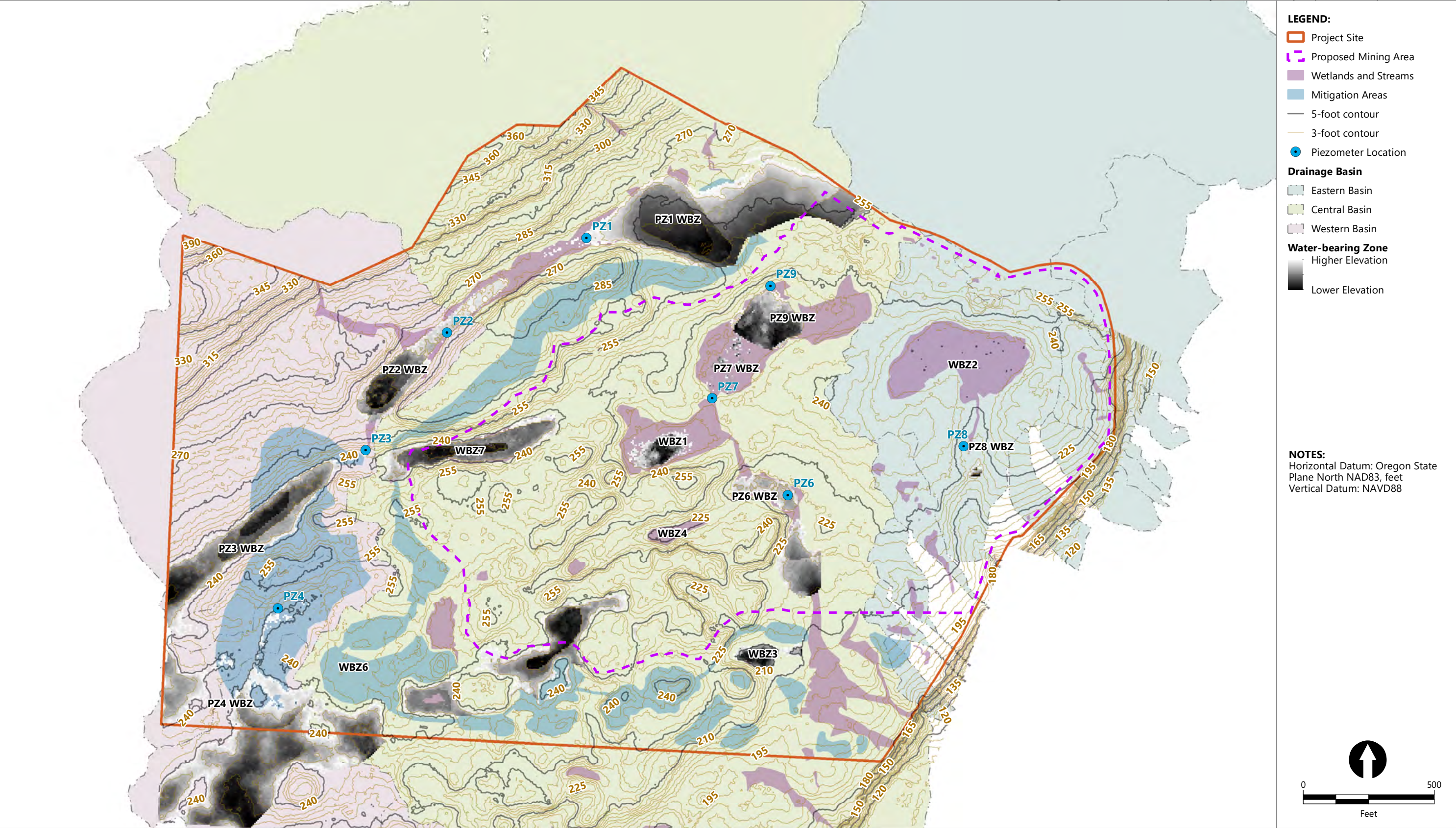
Figure A-13
June 1, 2021 Groundwater Elevation Map
 Watters Quarry Phase II Project



Publish Date: 2023/12/28, 11:36 AM | User: jfox
Filepath: \\orcas\GIS\Jobs\Knife_River_Corp_2114\Watters_Quarry\Maps\GroundwaterHydrology\AQ_WattersQuarry_GW_Analysis_Map_2021July.mxd



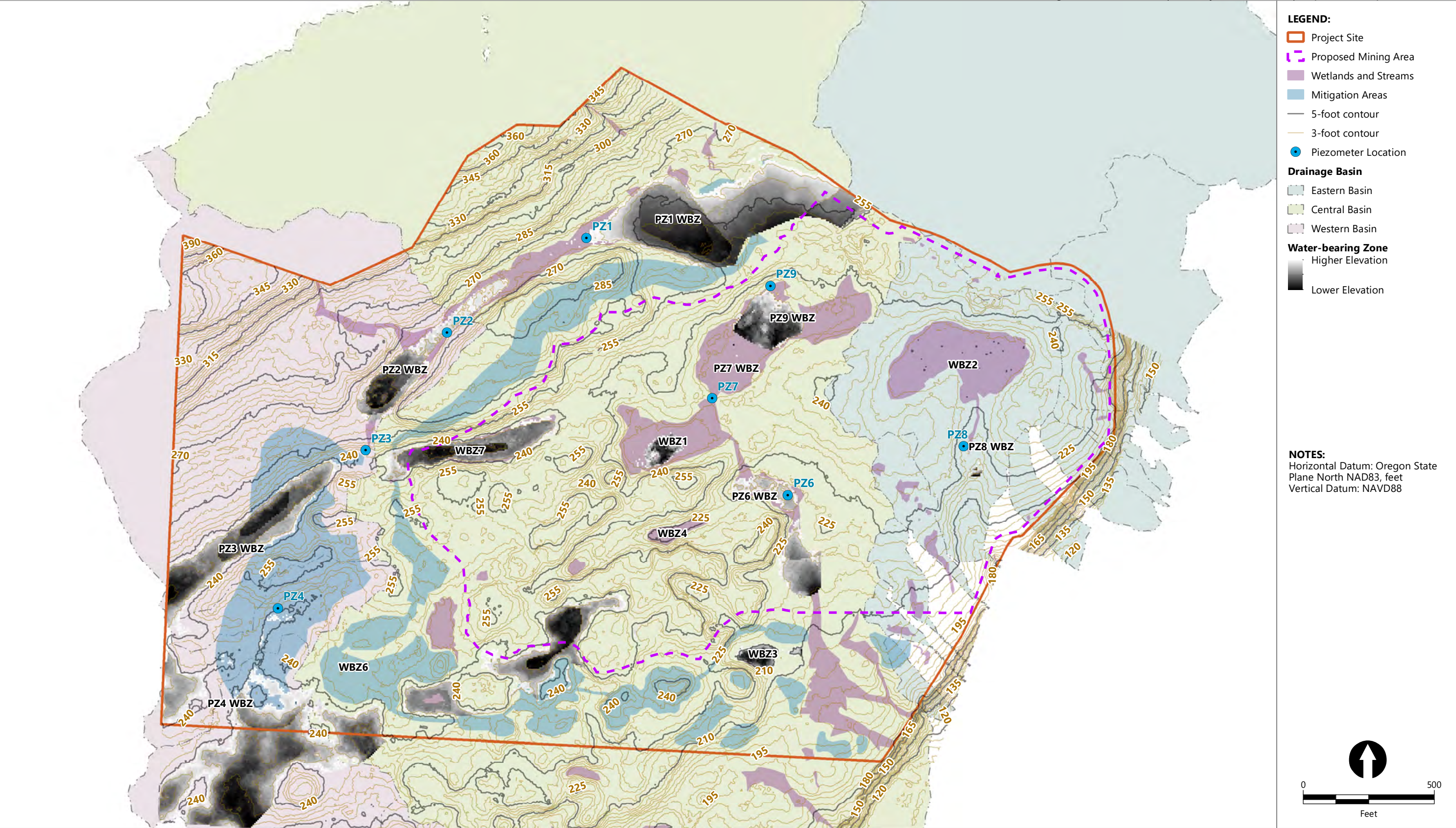
Figure A-14
July 1, 2021 Groundwater Elevation Map
 Watters Quarry Phase II Project



Publish Date: 2023/12/28, 11:38 AM | User: jfox
Filepath: \\orcas\GIS\Jobs\Knife_River_Corp_2114\Watters_Quarry\Maps\GroundwaterHydrology\AQ_WattersQuarry_GW_Analysis_Map_2021August.mxd



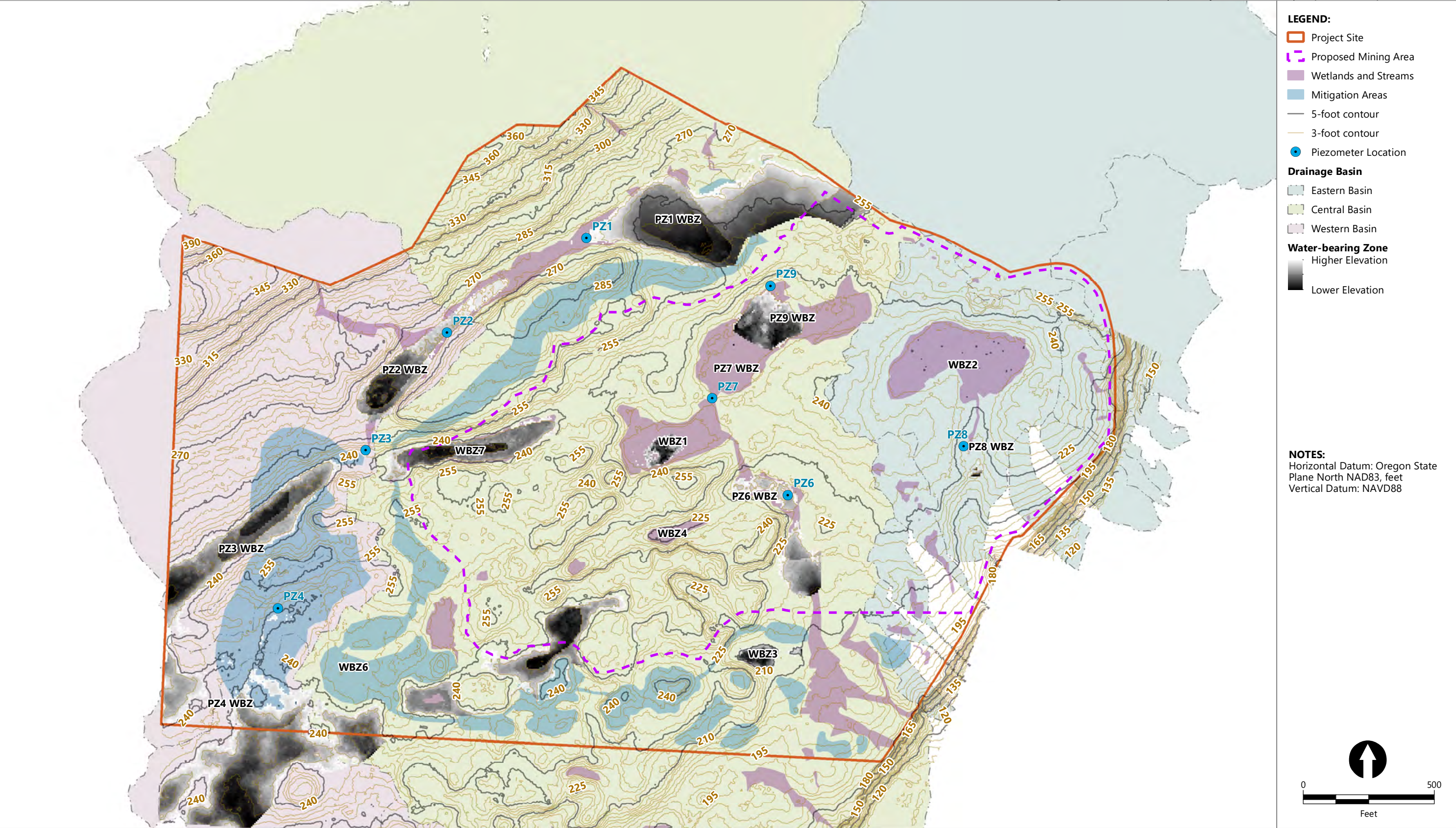
Figure A-15
August 1, 2021 Groundwater Elevation Map
 Watters Quarry Phase II Project



Publish Date: 2023/12/28, 11:40 AM | User: jfox
Filepath: \\orcas\GIS\Jobs\Knife_River_Corp_2114\Watters_Quarry\Maps\GroundwaterHydrology\AQ_WattersQuarry_GW_Analysis_Map_2021September.mxd



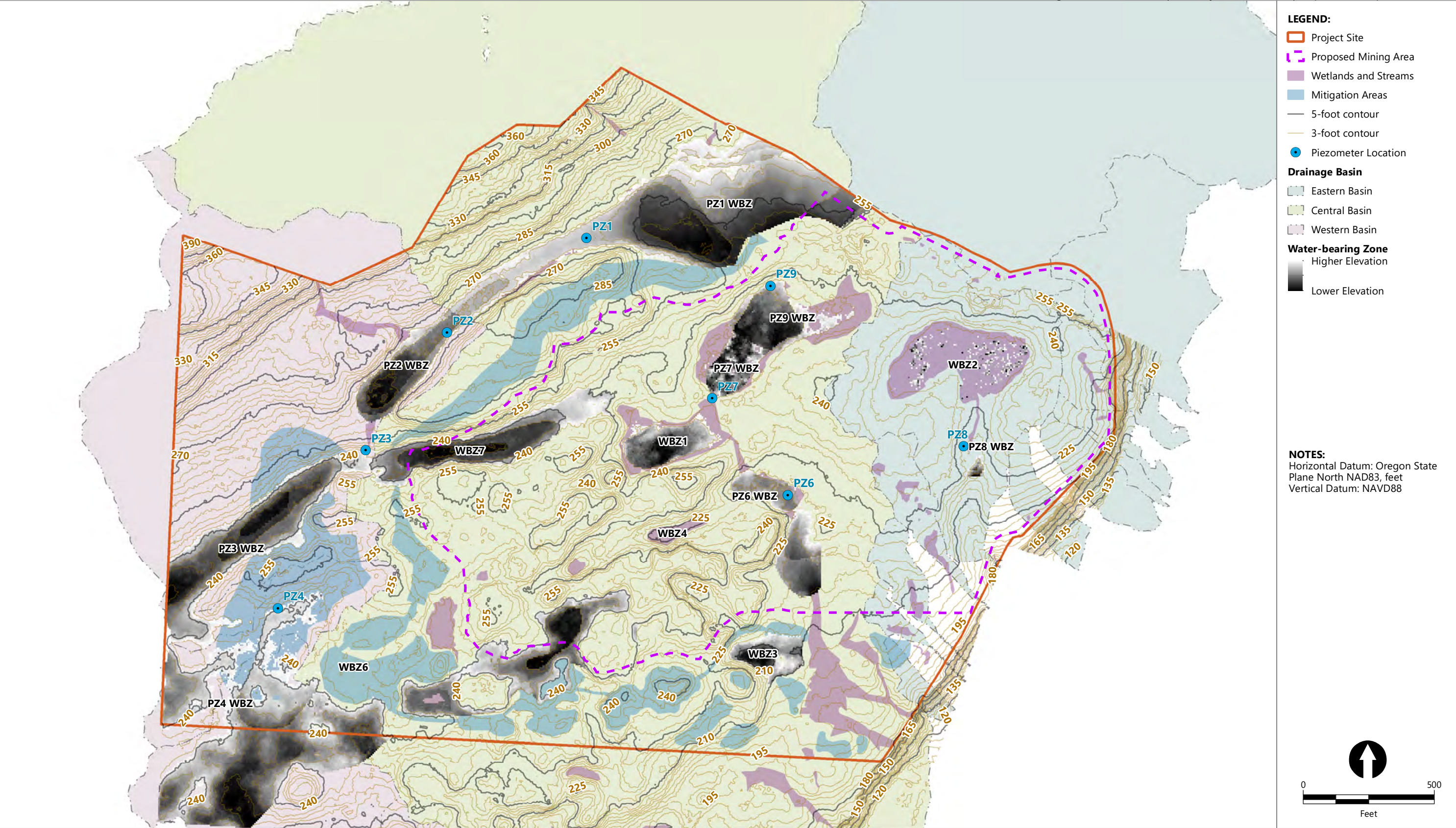
Figure A-16
September 1, 2021 Groundwater Elevation Map
 Watters Quarry Phase II Project



Publish Date: 2023/12/28, 11:42 AM | User: jfox
Filepath: \\orcas\GIS\Jobs\Knife_River_Corp_2114\Watters_Quarry\Maps\GroundwaterHydrology\AQ_WattersQuarry_GW_Analysis_Map_2021October.mxd



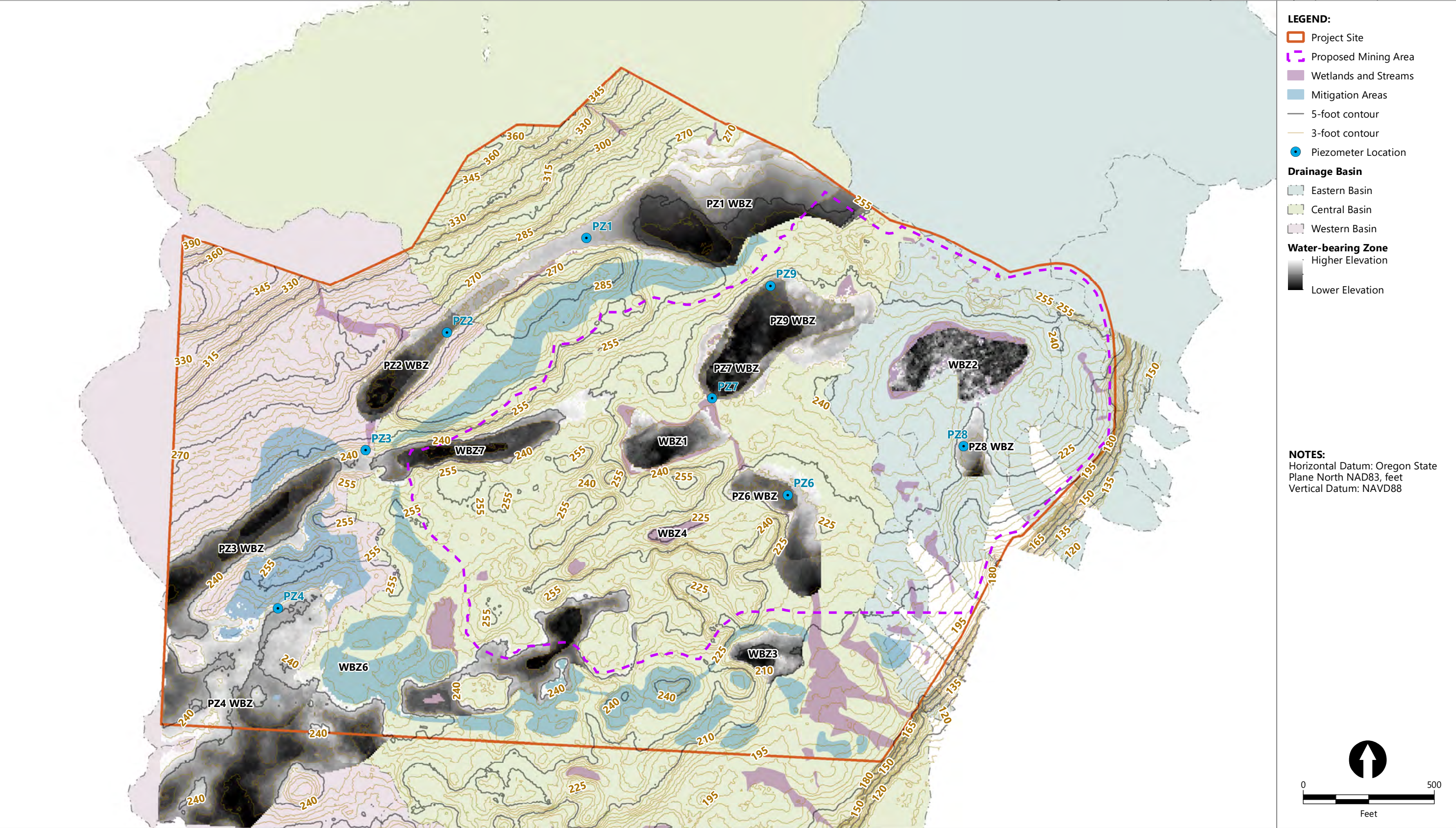
Figure A-17
October 1, 2021 Groundwater Elevation Map
 Watters Quarry Phase II Project



Publish Date: 2023/12/28, 11:43 AM | User: jfox
Filepath: \\orcas\GIS\Jobs\Knife_River_Corp_2114\Watters_Quarry\Maps\GroundwaterHydrology\AQ_WattersQuarry_GW_Analysis_Map_2021November.mxd



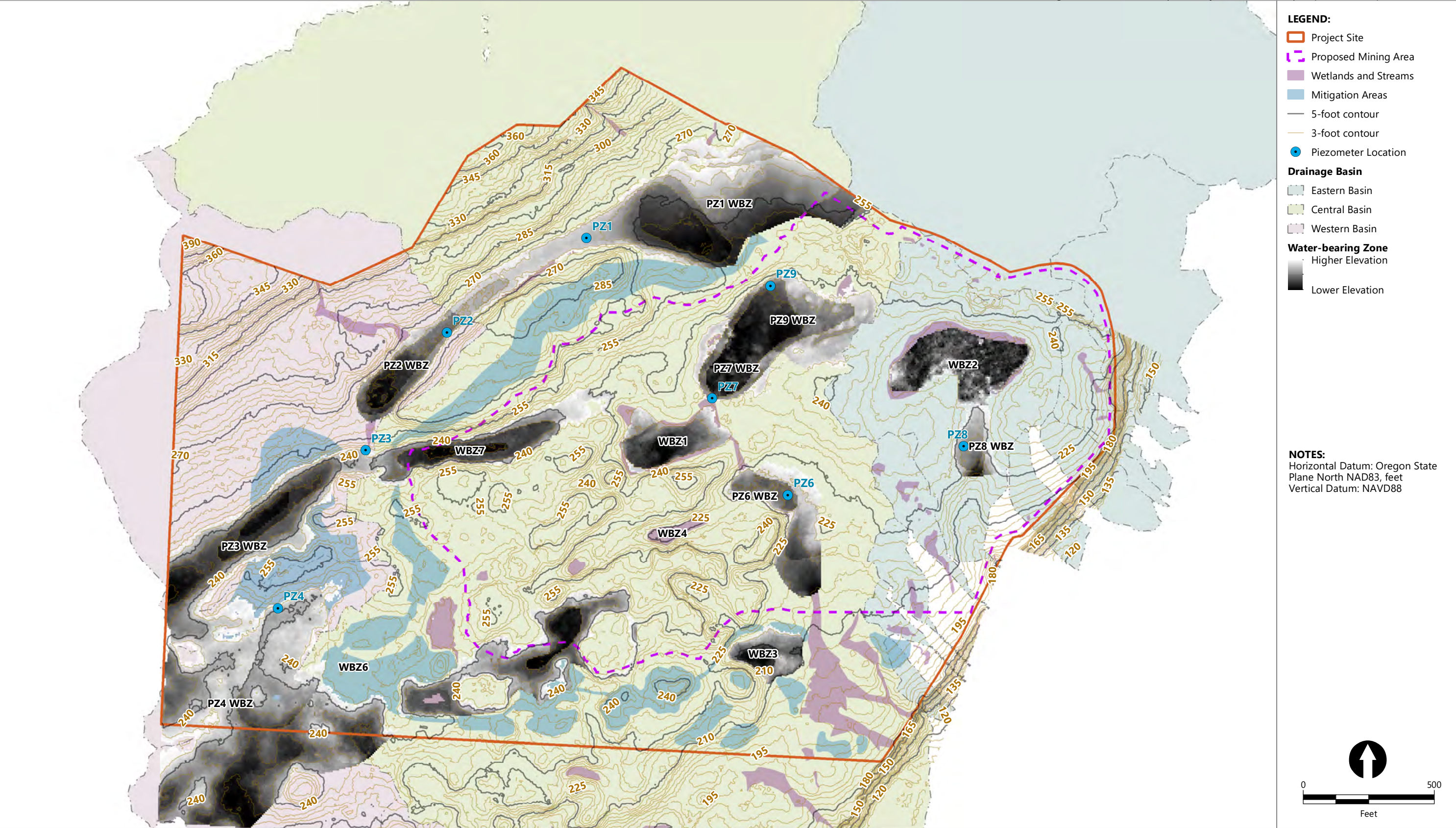
Figure A-18
November 1, 2021 Groundwater Elevation Map
 Watters Quarry Phase II Project



Publish Date: 2023/12/28, 11:45 AM | User: jfox
Filepath: \\orcas\GIS\Jobs\Knife_River_Corp_2114\Watters_Quarry\Maps\GroundwaterHydrology\AQ_WattersQuarry_GW_Analysis_Map_2021December.mxd



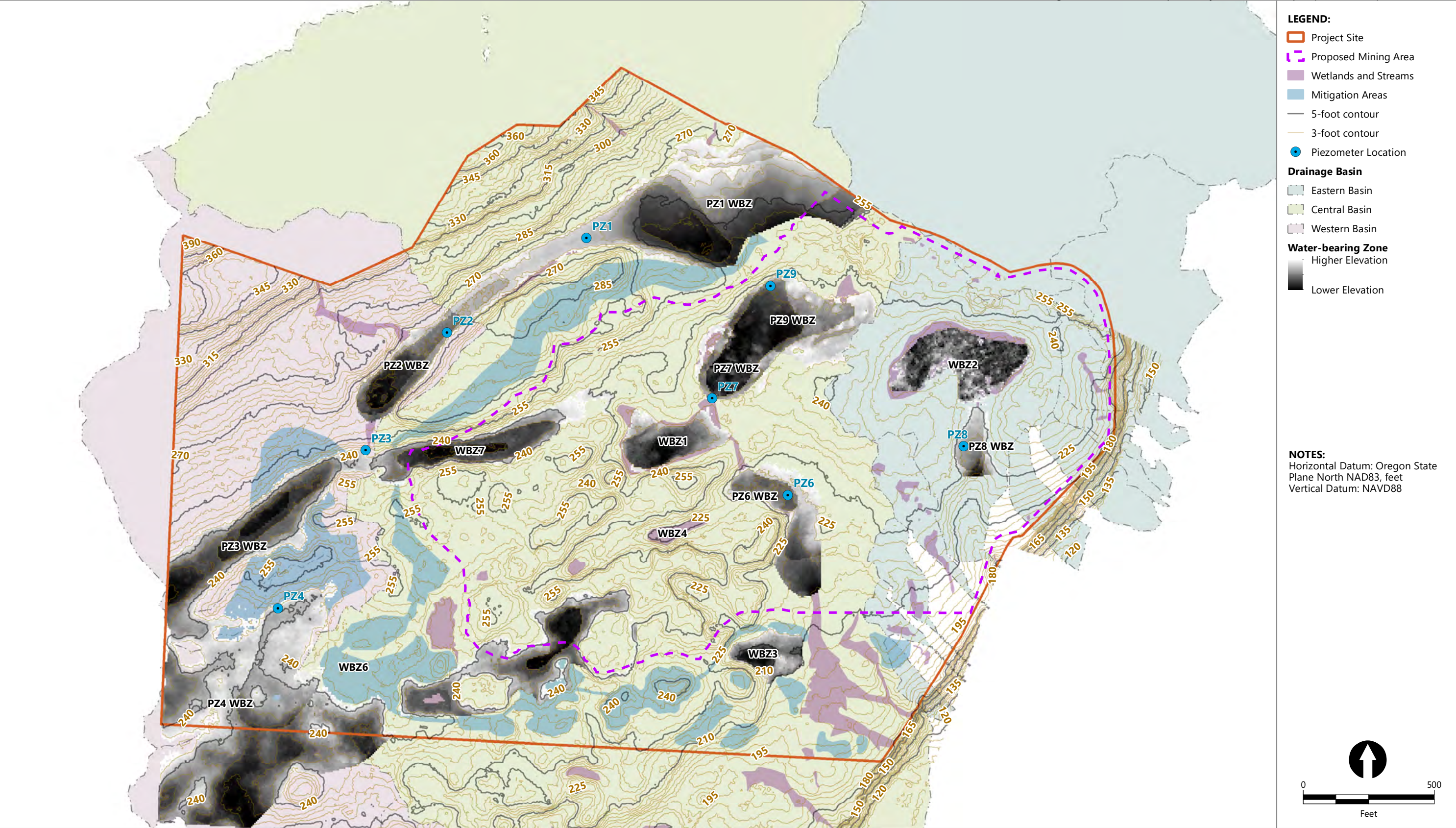
Figure A-19
December 1, 2021 Groundwater Elevation Map
Watters Quarry Phase II Project



Publish Date: 2023/12/28, 11:47 AM | User: jfox
Filepath: \\orcas\GIS\Jobs\Knife_River_Corp_2114\Watters_Quarry\Maps\GroundwaterHydrology\AQ_WattersQuarry_GW_Analysis_Map_2022January.mxd



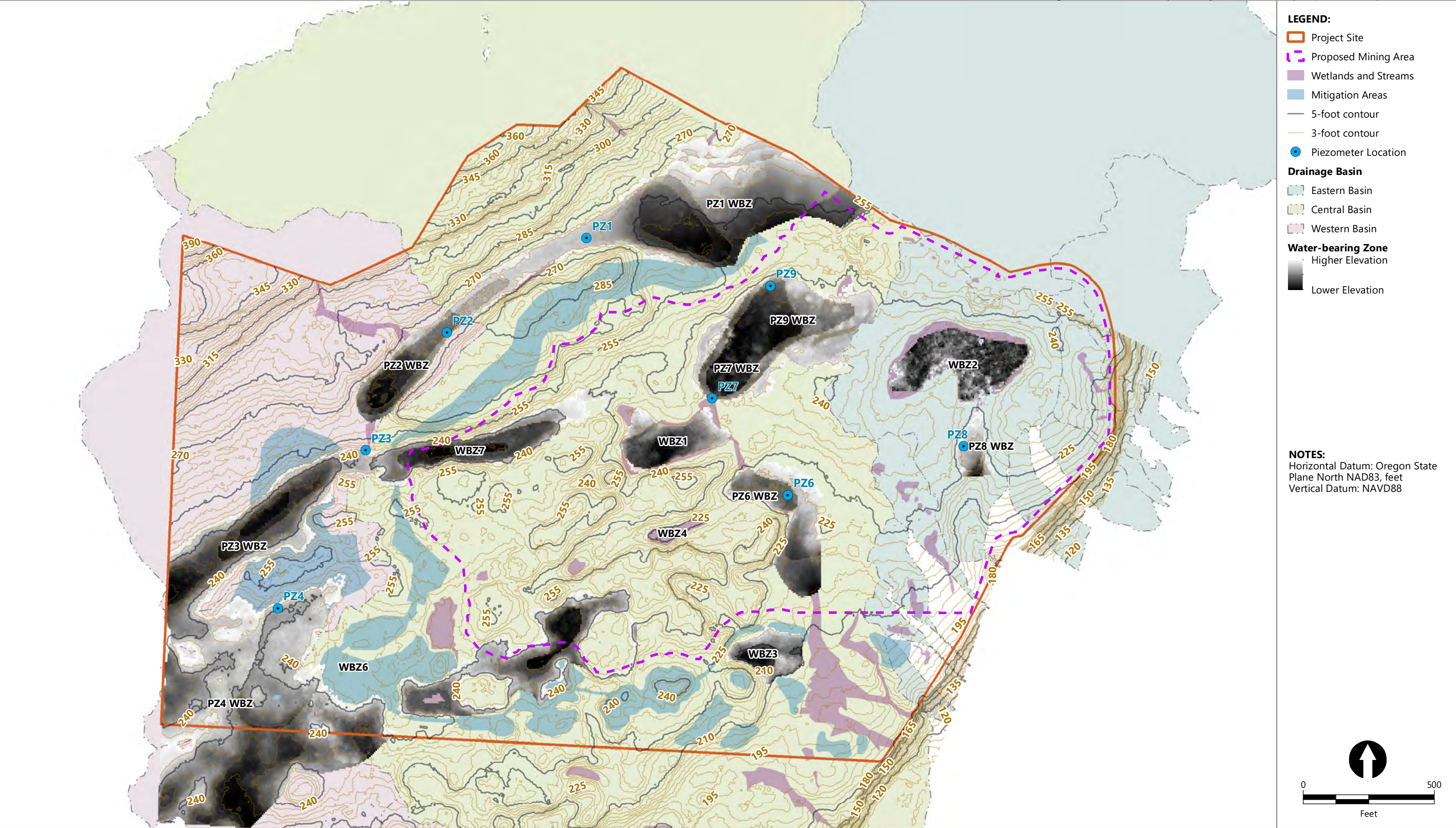
Figure A-20
January 1, 2022 Groundwater Elevation Map
 Watters Quarry Phase II Project



Publish Date: 2023/12/28, 11:49 AM | User: jfox
Filepath: \\orcas\GIS\Jobs\Knife_River_Corp_2114\Watters_Quarry\Maps\GroundwaterHydrology\AQ_WattersQuarry_GW_Analysis_Map_2022February.mxd



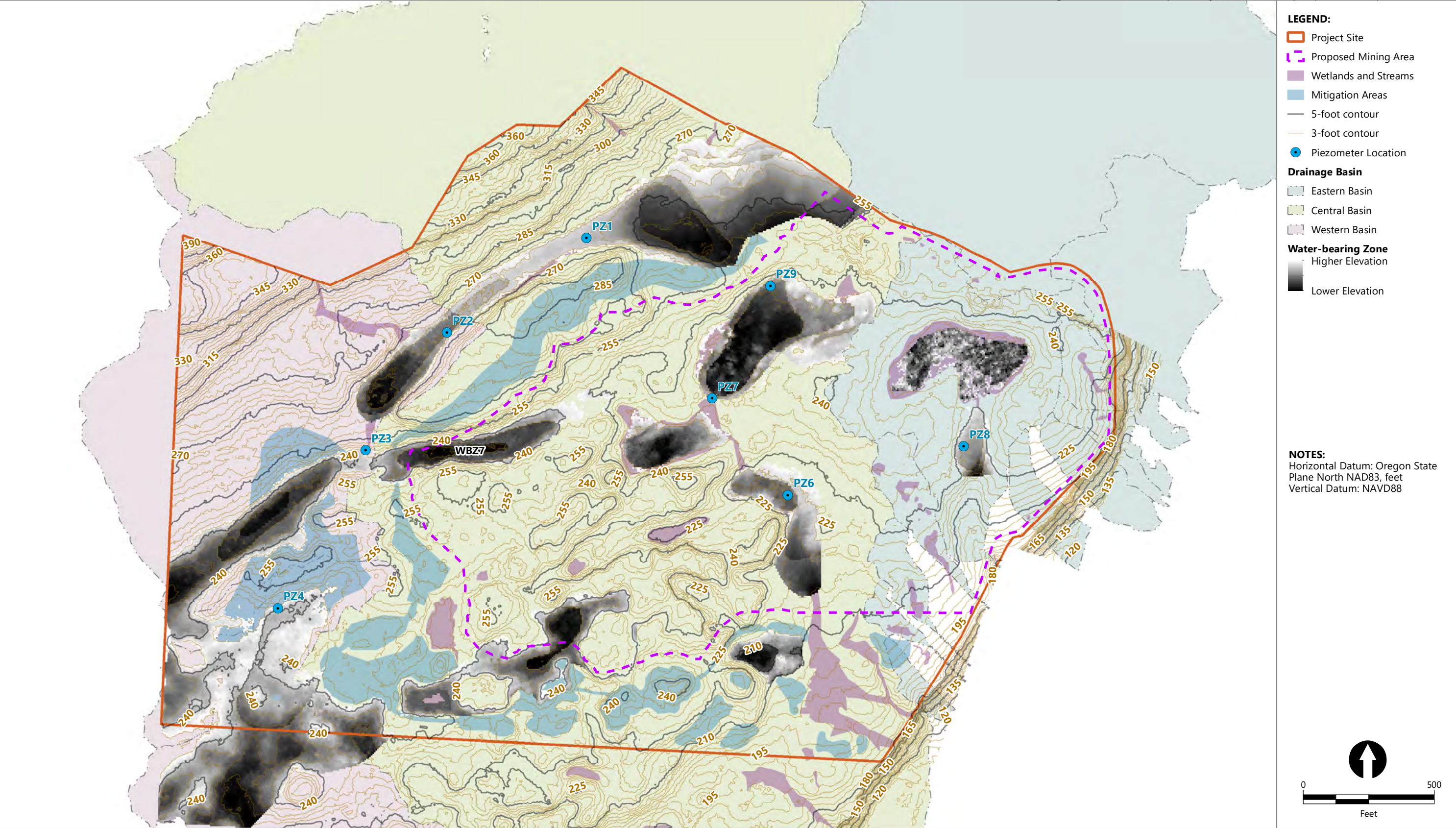
Figure A-21
February 1, 2022 Groundwater Elevation Map
 Watters Quarry Phase II Project



Publish Date: 2023/12/28, 11:51 AM | User: jfox
Filepath: \\orcas\GIS\Jobs\Knife_River_Corp_2114\Watters_Quarry\Maps\GroundwaterHydrology\AQ_WattersQuarry_GW_Analysis_Map_2022March.mxd

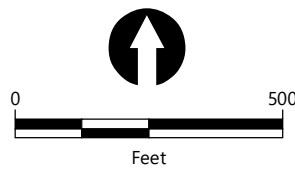


Figure A-22
March 1, 2022 Groundwater Elevation Map
 Watters Quarry Phase II Project



- LEGEND:**
- Project Site
 - Proposed Mining Area
 - Wetlands and Streams
 - Mitigation Areas
 - 5-foot contour
 - 3-foot contour
 - Piezometer Location
- Drainage Basin**
- Eastern Basin
 - Central Basin
 - Western Basin
- Water-bearing Zone**
- Higher Elevation
 - Lower Elevation

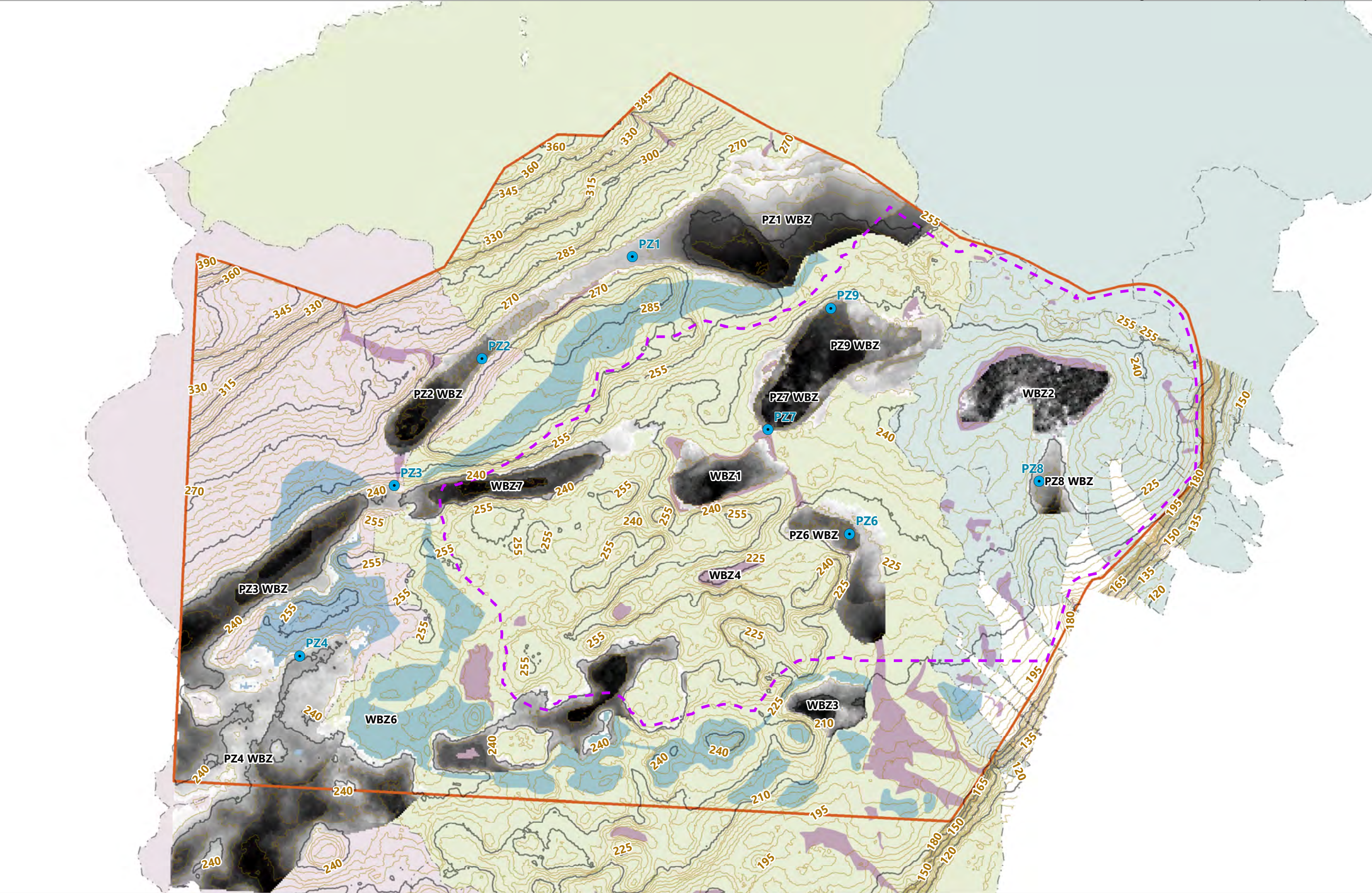
NOTES:
 Horizontal Datum: Oregon State Plane North NAD83, feet
 Vertical Datum: NAVD88



Publish Date: 2023/12/28, 11:52 AM | User: jfox
 Filepath: \\orcas\GIS\Jobs\Knife_River_Corp_2114\Watters_Quarry\Maps\GroundwaterHydrology\AQ_WattersQuarry_GW_Analysis_Map_2022April.mxd



Figure A-23
April 1, 2022 Groundwater Elevation Map
 Watters Quarry Phase II Project



LEGEND:

- Project Site
- Proposed Mining Area
- Wetlands and Streams
- Mitigation Areas
- 5-foot contour
- 3-foot contour
- Piezometer Location

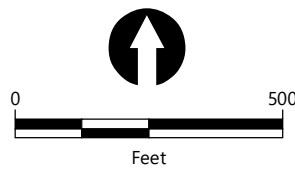
Drainage Basin

- Eastern Basin
- Central Basin
- Western Basin

Water-bearing Zone

- Higher Elevation
- Lower Elevation

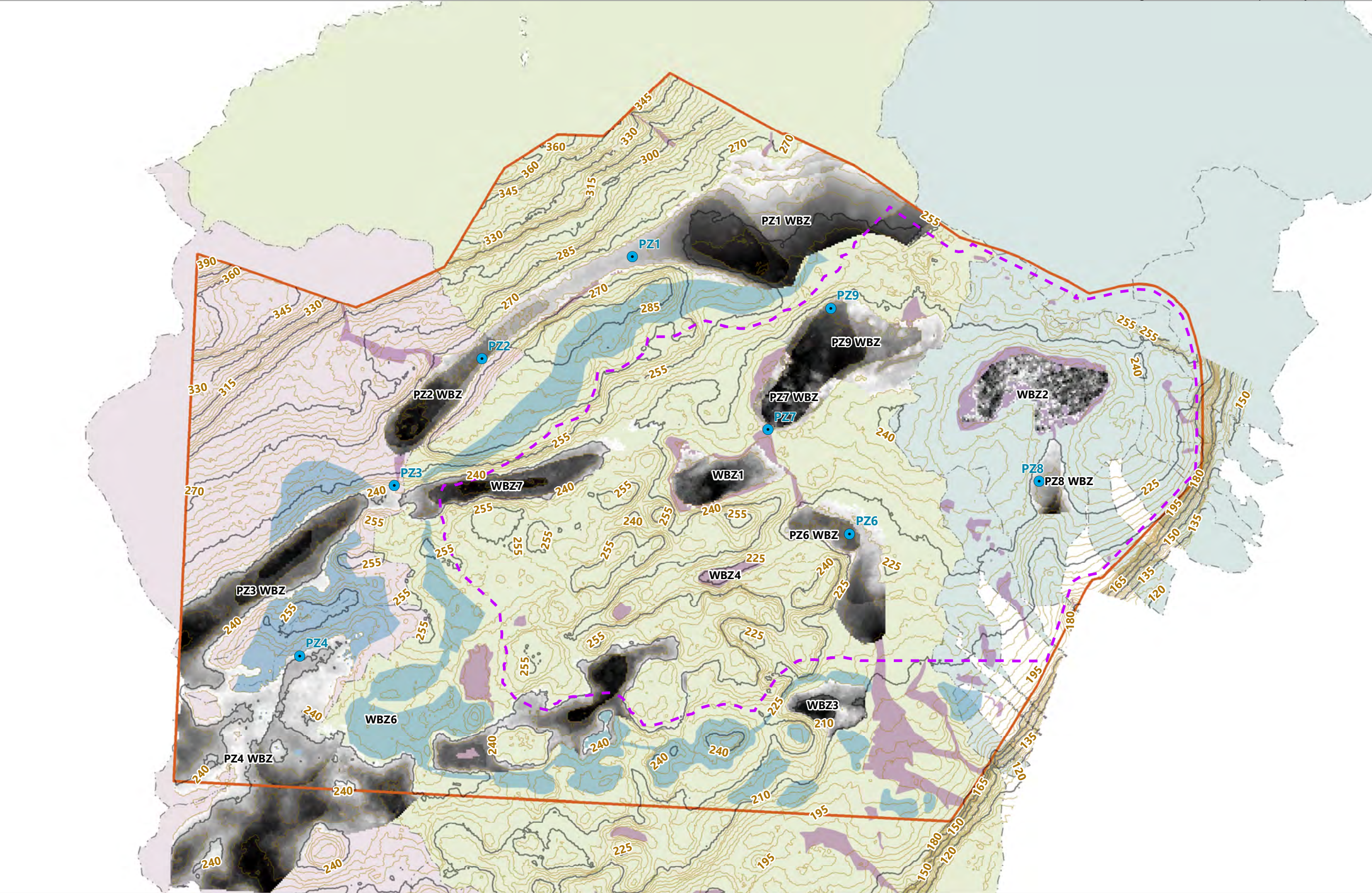
NOTES:
 Horizontal Datum: Oregon State Plane North NAD83, feet
 Vertical Datum: NAVD88



Publish Date: 2023/12/28, 11:54 AM | User: jfox
 Filepath: \\orcas\GIS\Jobs\Knife_River_Corp_2114\Watters_Quarry\Maps\GroundwaterHydrology\AQ_WattersQuarry_GW_Analysis_Map_2022May01.mxd

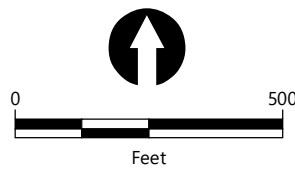


Figure A-24
May 1, 2022 Groundwater Elevation Map
 Watters Quarry Phase II Project



- LEGEND:**
- Project Site
 - Proposed Mining Area
 - Wetlands and Streams
 - Mitigation Areas
 - 5-foot contour
 - 3-foot contour
 - Piezometer Location
- Drainage Basin**
- Eastern Basin
 - Central Basin
 - Western Basin
- Water-bearing Zone**
- Higher Elevation
 - Lower Elevation

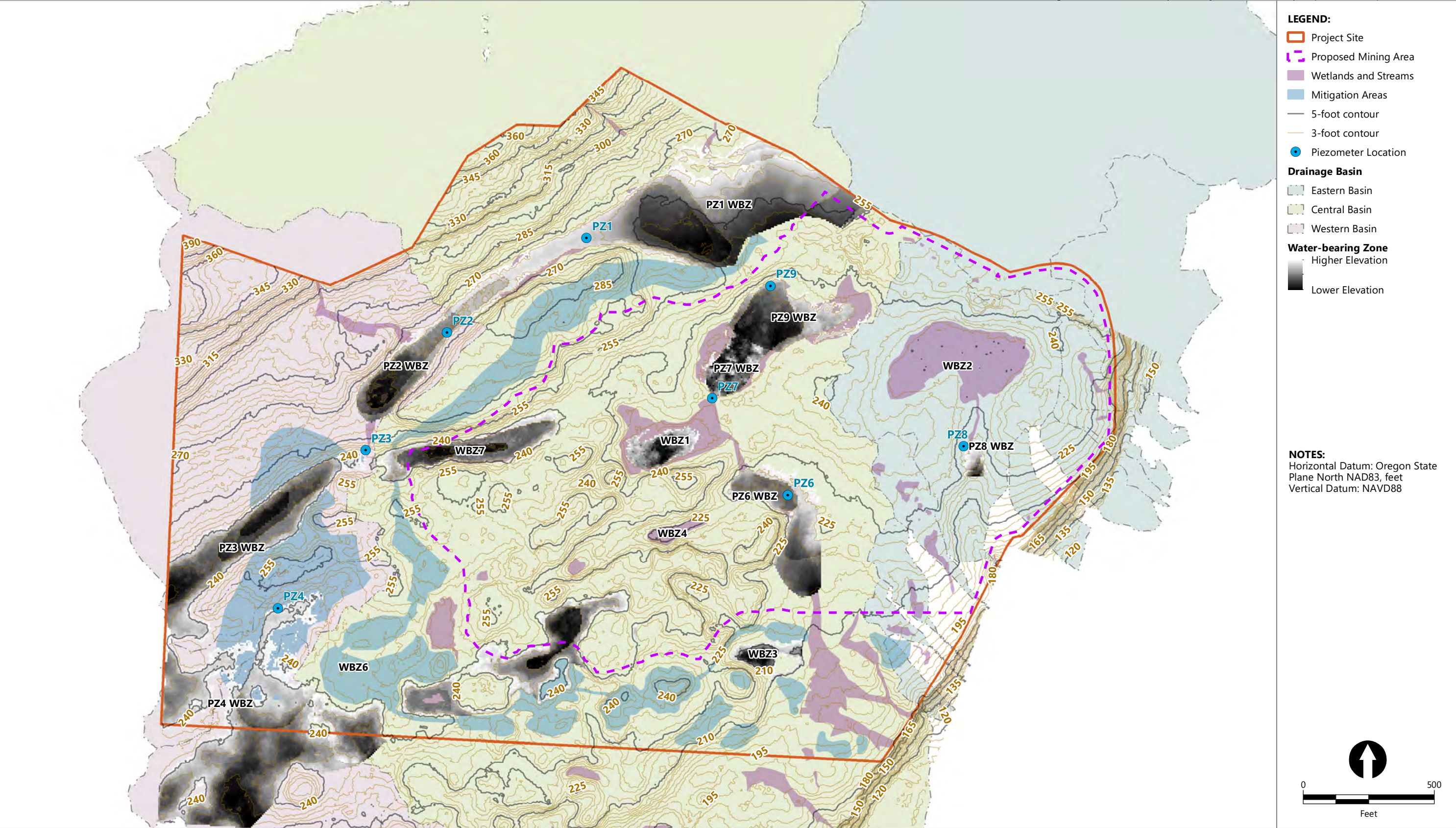
NOTES:
 Horizontal Datum: Oregon State Plane North NAD83, feet
 Vertical Datum: NAVD88



Publish Date: 2023/12/28, 11:56 AM | User: jfox
 Filepath: \\orcas\GIS\Jobs\Knife_River_Corp_2114\Watters_Quarry\Maps\GroundwaterHydrology\AQ_WattersQuarry_GW_Analysis_Map_2022\June.mxd



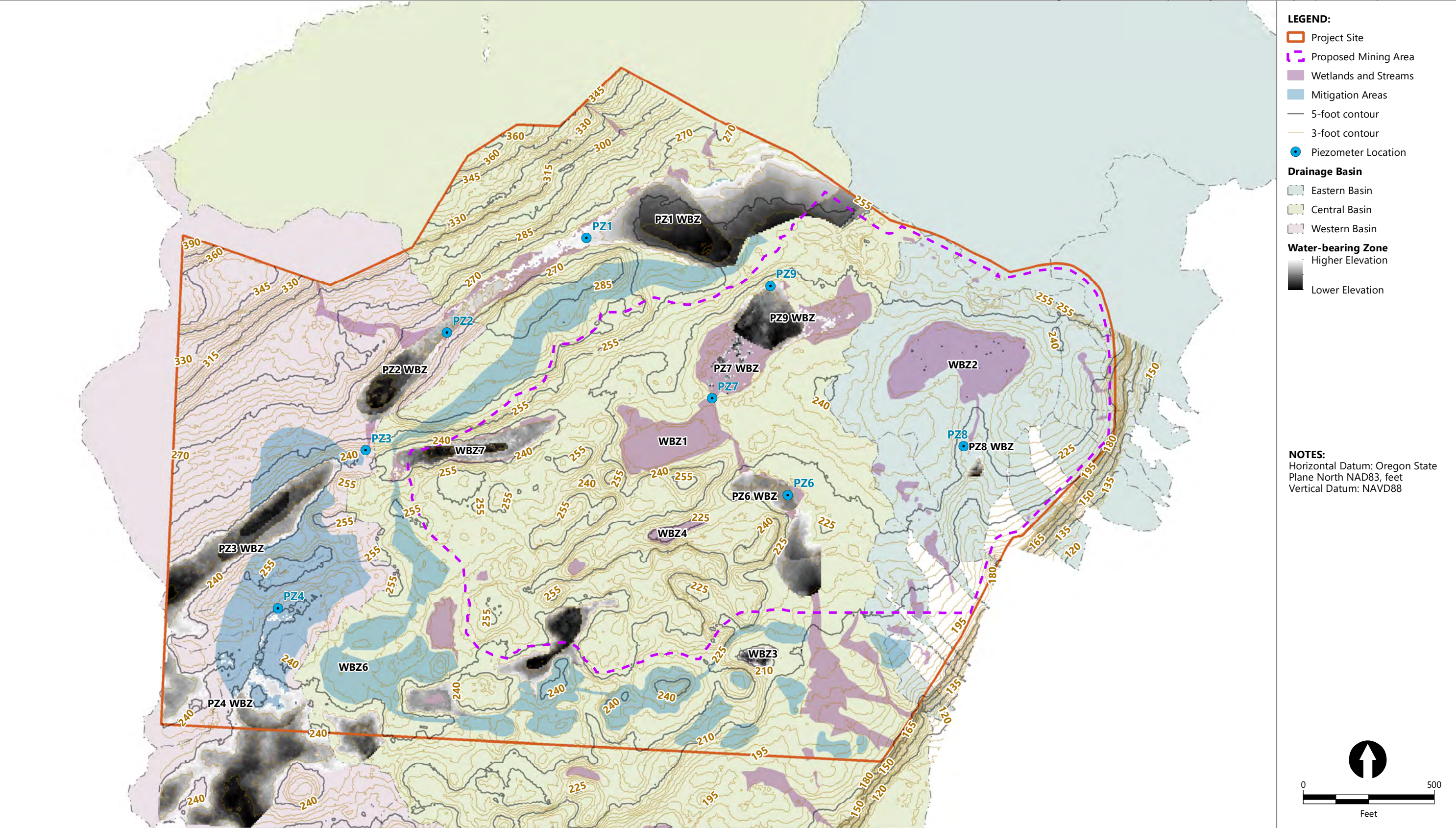
Figure A-25
June 1, 2022 Groundwater Elevation Map
 Watters Quarry Phase II Project



Publish Date: 2023/12/28, 11:57 AM | User: jfox
Filepath: \\orcas\GIS\Jobs\Knife_River_Corp_2114\Watters_Quarry\Maps\GroundwaterHydrology\AQ_WattersQuarry_GW_Analysis_Map_2022July.mxd



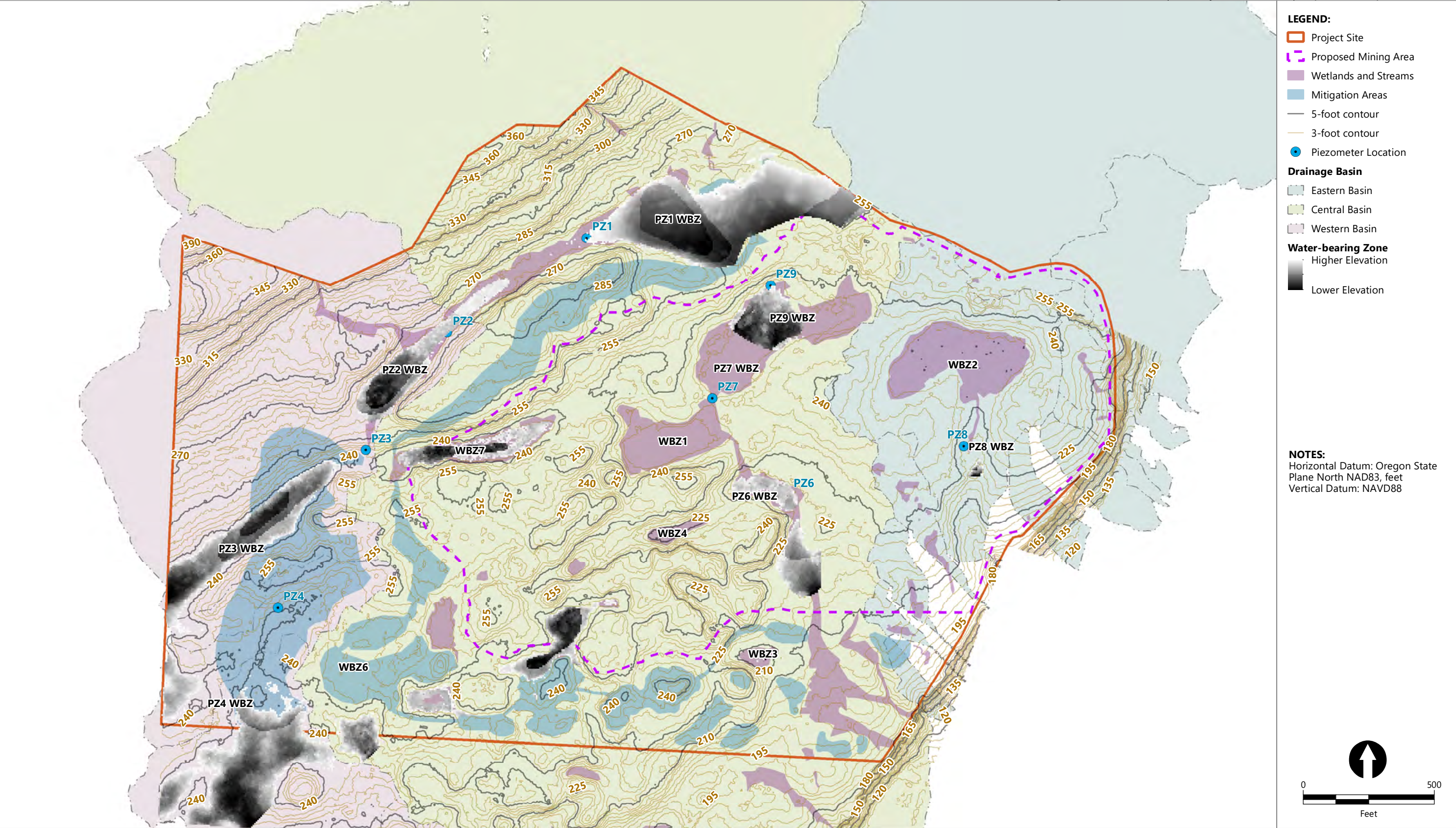
Figure A-26
July 1, 2022 Groundwater Elevation Map
 Watters Quarry Phase II Project



Publish Date: 2023/12/28, 12:00 PM | User: jfox
Filepath: \\orcas\GIS\Jobs\Knife_River_Corp_2114\Watters_Quarry\Maps\GroundwaterHydrology\AQ_WattersQuarry_GW_Analysis_Map_2022August.mxd



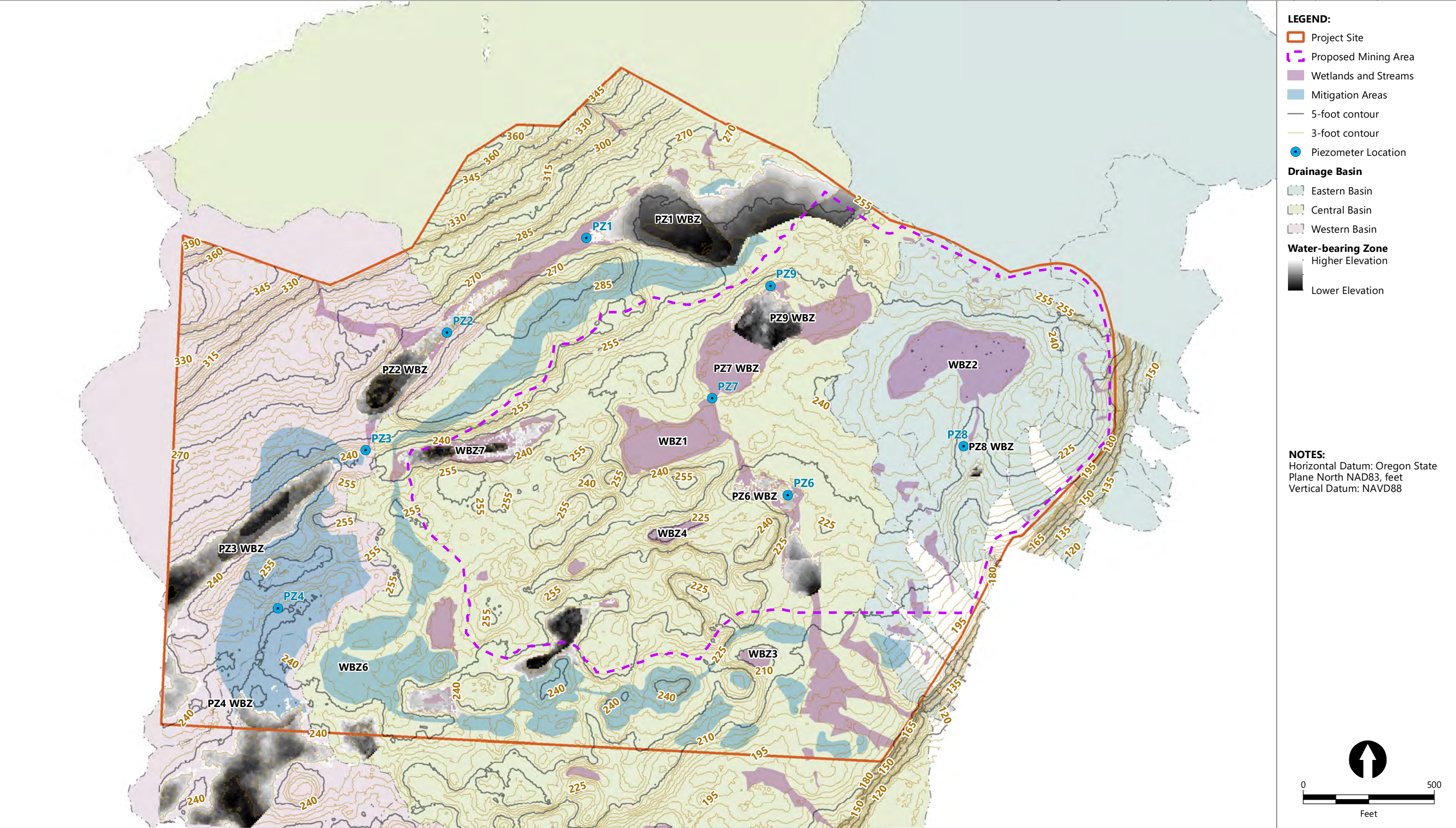
Figure A-27
August 1, 2022 Groundwater Elevation Map
 Watters Quarry Phase II Project



Publish Date: 2023/12/28, 12:03 PM | User: jfox
Filepath: \\orcas\GIS\Jobs\Knife_River_Corp_2114\Watters_Quarry\Maps\GroundwaterHydrology\AQ_WattersQuarry_GW_Analysis_Map_2022September.mxd



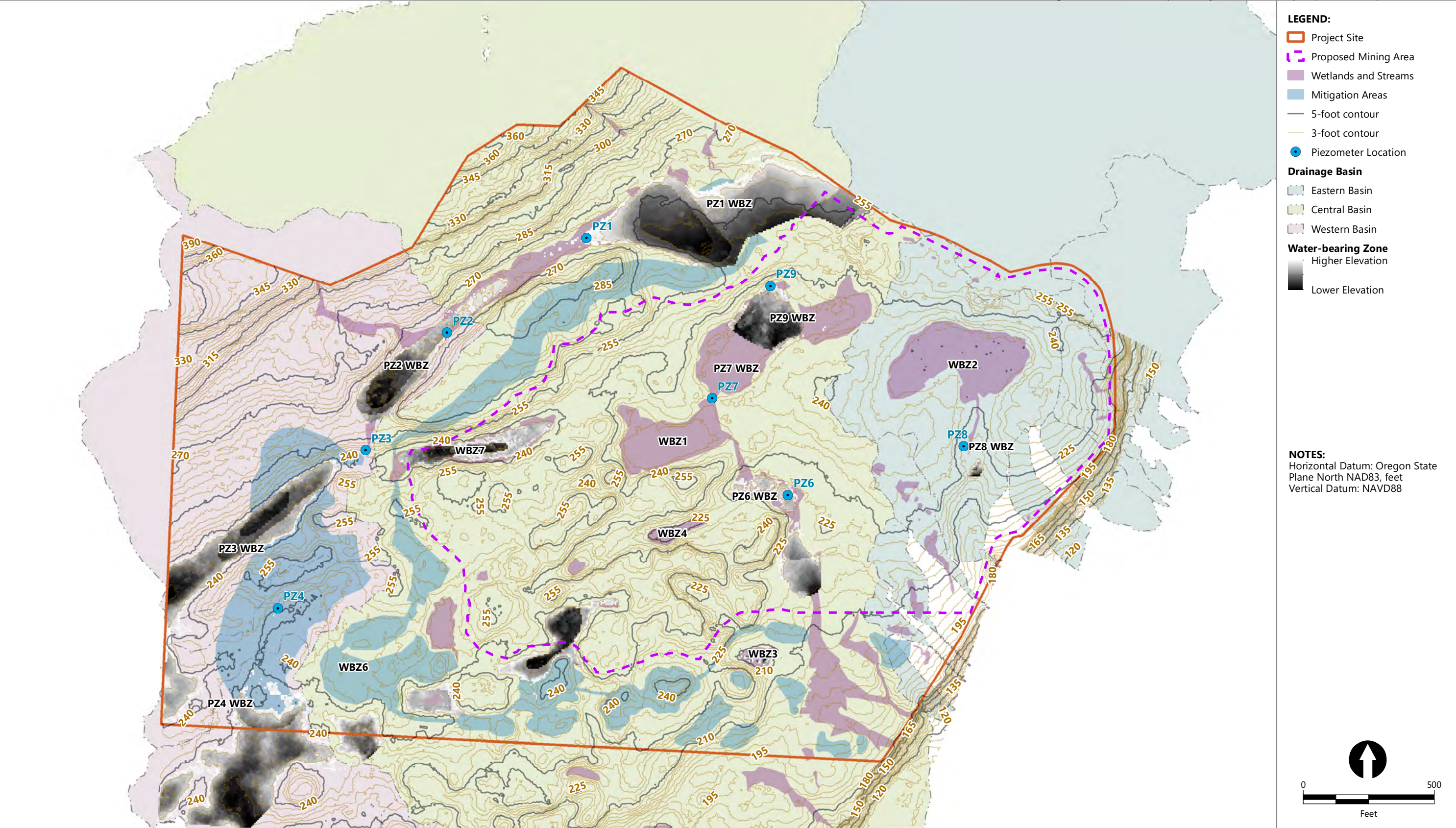
Figure A-28
September 1, 2022 Groundwater Elevation Map
 Watters Quarry Phase II Project



Publish Date: 2023/12/28, 12:05 PM | User: jfox
Filepath: \\orcas\GIS\Jobs\Knife_River_Corp_2114\Watters_Quarry\Maps\GroundwaterHydrology\AQ_WattersQuarry_GW_Analysis_Map_2022October.mxd



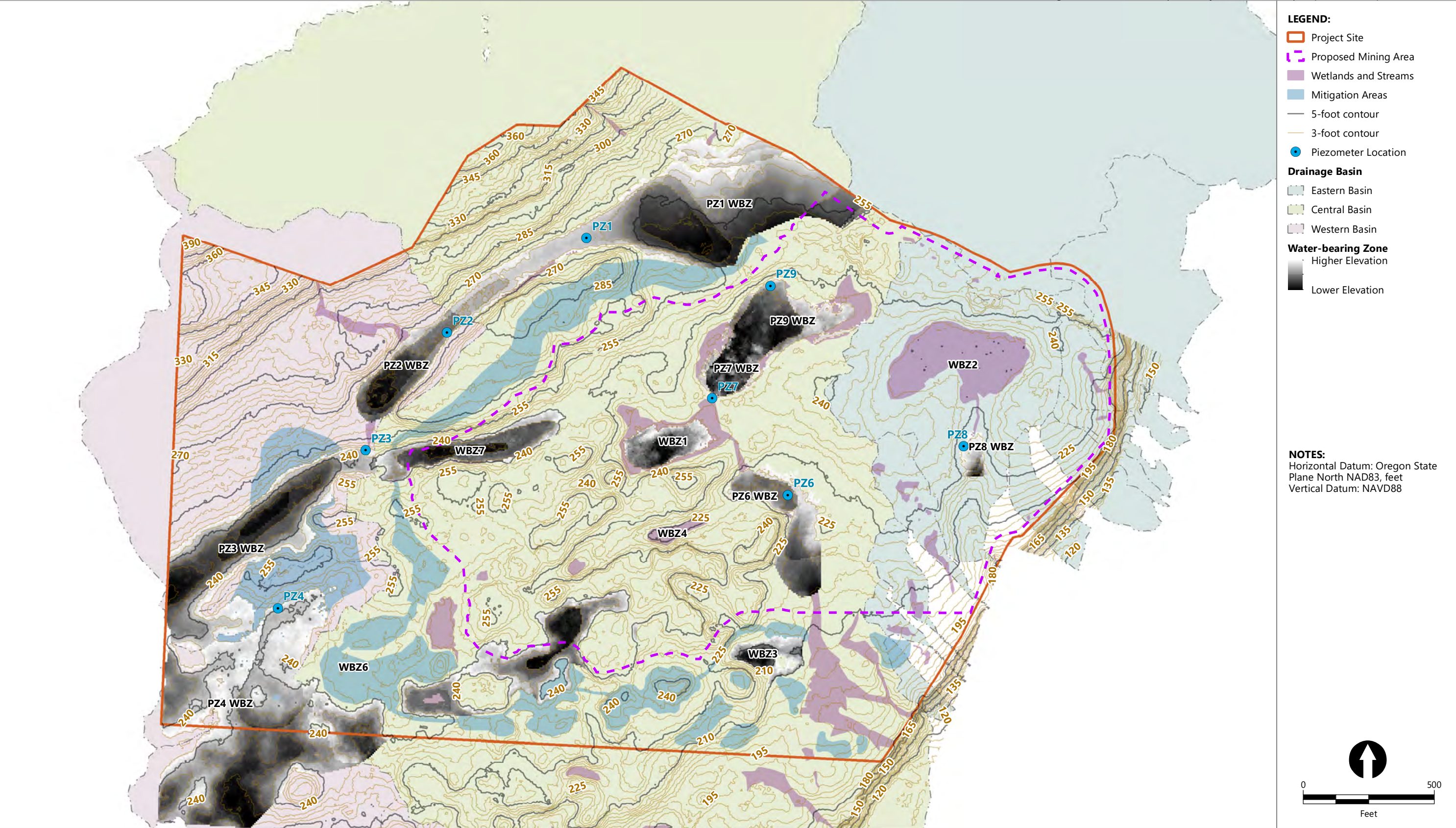
Figure A-29
October 1, 2022 Groundwater Elevation Map
 Watters Quarry Phase II Project



Publish Date: 2023/12/28, 12:08 PM | User: jfox
Filepath: \\orcas\GIS\Jobs\Knife_River_Corp_2114\Watters_Quarry\Maps\GroundwaterHydrology\AQ_WattersQuarry_GW_Analysis_Map_2022November.mxd



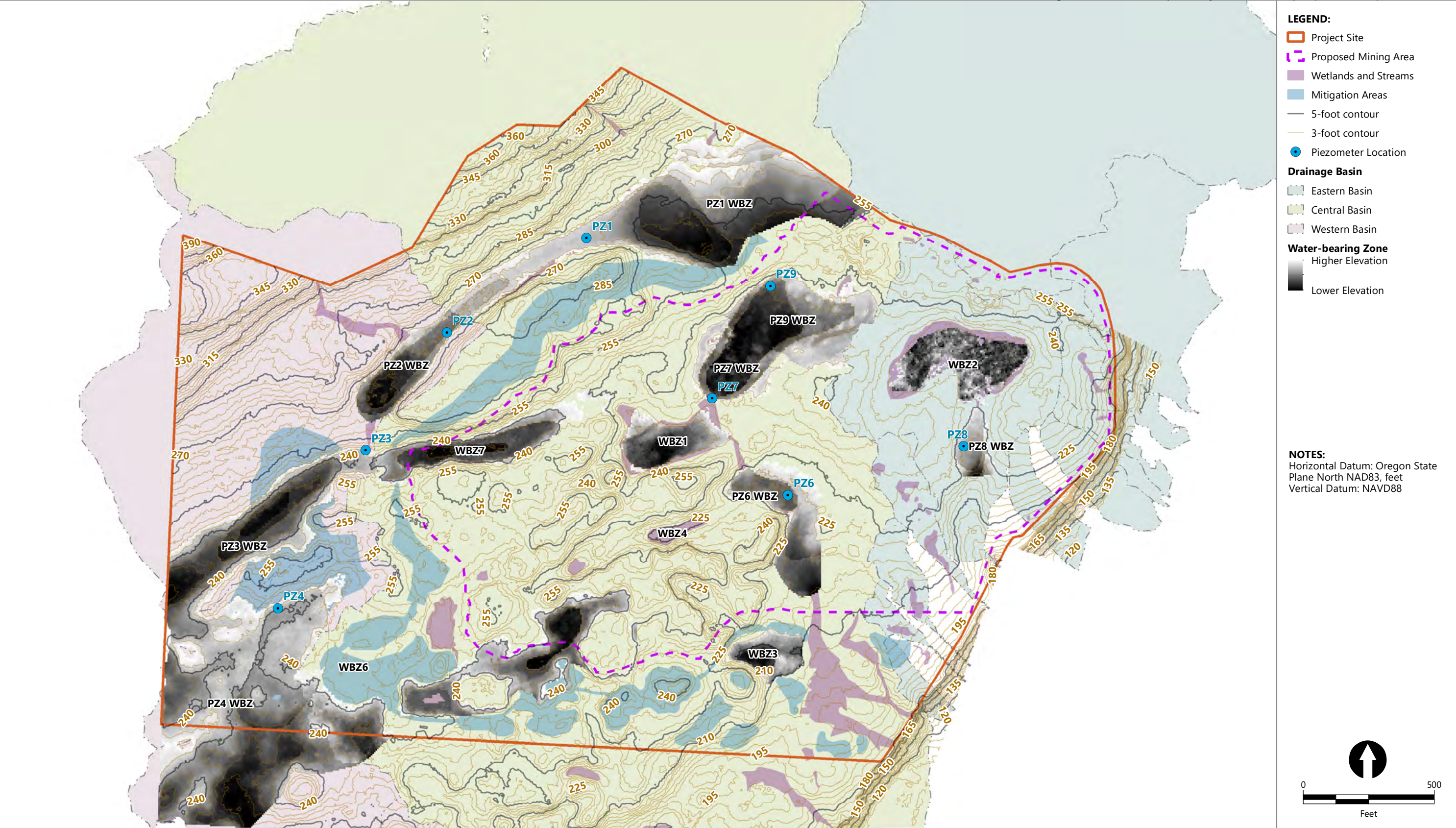
Figure A-30
November 1, 2022 Groundwater Elevation Map
 Watters Quarry Phase II Project



Publish Date: 2023/12/28, 12:09 PM | User: jfox
Filepath: \\orcas\GIS\Jobs\Knife_River_Corp_2114\Watters_Quarry\Maps\GroundwaterHydrology\AQ_WattersQuarry_GW_Analysis_Map_2022December.mxd



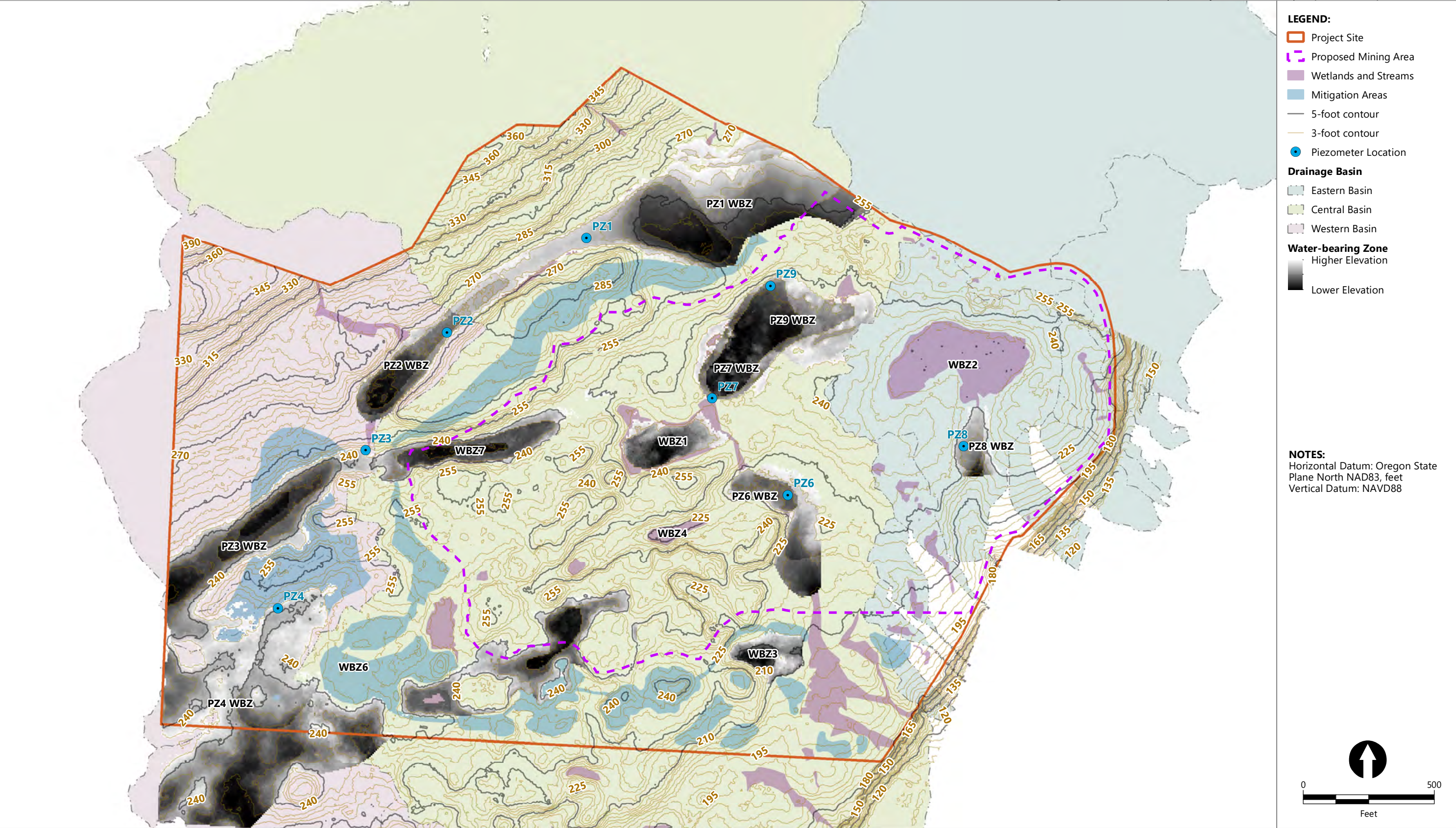
Figure A-31
December 1, 2022 Groundwater Elevation Map
 Watters Quarry Phase II Project



Publish Date: 2023/12/28, 12:12 PM | User: jfox
Filepath: \\orcas\GIS\Jobs\Knife_River_Corp_2114\Watters_Quarry\Maps\GroundwaterHydrology\AQ_WattersQuarry_GW_Analysis_Map_2023January.mxd



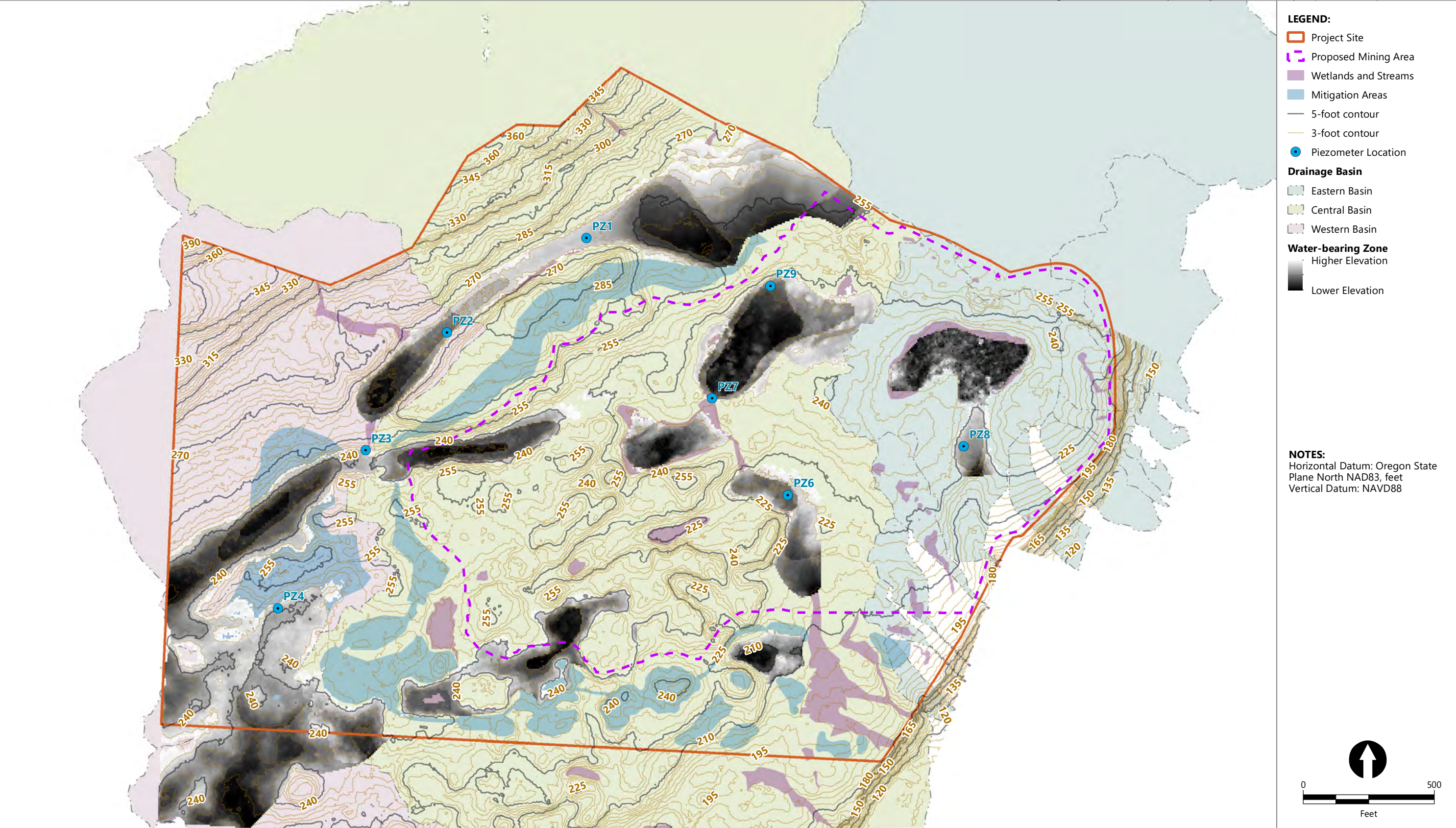
Figure A-32
January 1, 2023 Groundwater Elevation Map
 Watters Quarry Phase II Project



Publish Date: 2023/12/28, 12:15 PM | User: jfox
Filepath: \\orcas\GIS\Jobs\Knife_River_Corp_2114\Watters_Quarry\Maps\GroundwaterHydrology\AQ_WattersQuarry_GW_Analysis_Map_2023February.mxd



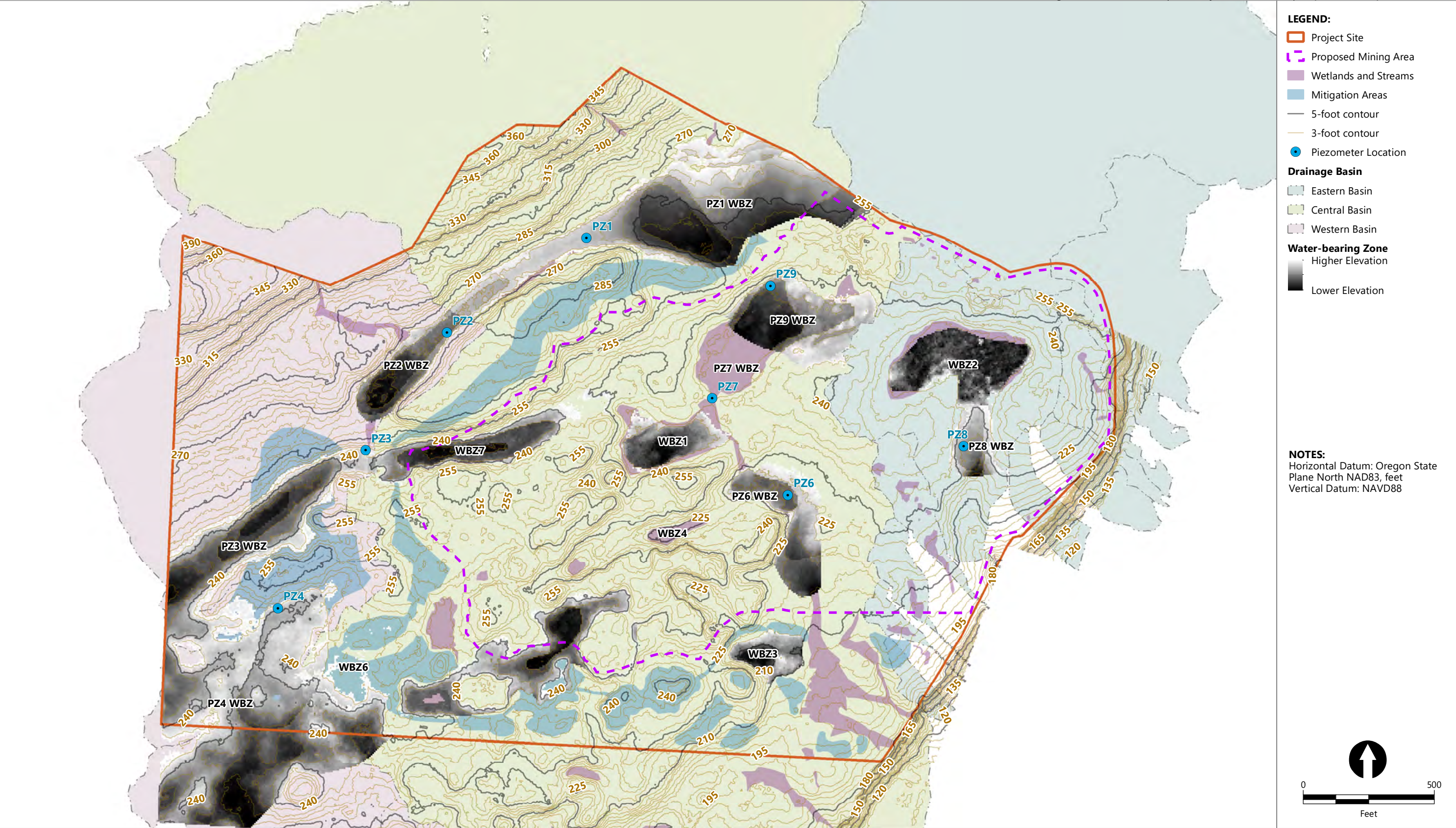
Figure A-33
February 1, 2023 Groundwater Elevation Map
 Watters Quarry Phase II Project



Publish Date: 2023/12/28, 12:17 PM | User: jfox
Filepath: \\orcas\GIS\Jobs\Knife_River_Corp_2114\Watters_Quarry\Maps\GroundwaterHydrology\AQ_WattersQuarry_GW_Analysis_Map_2023March.mxd



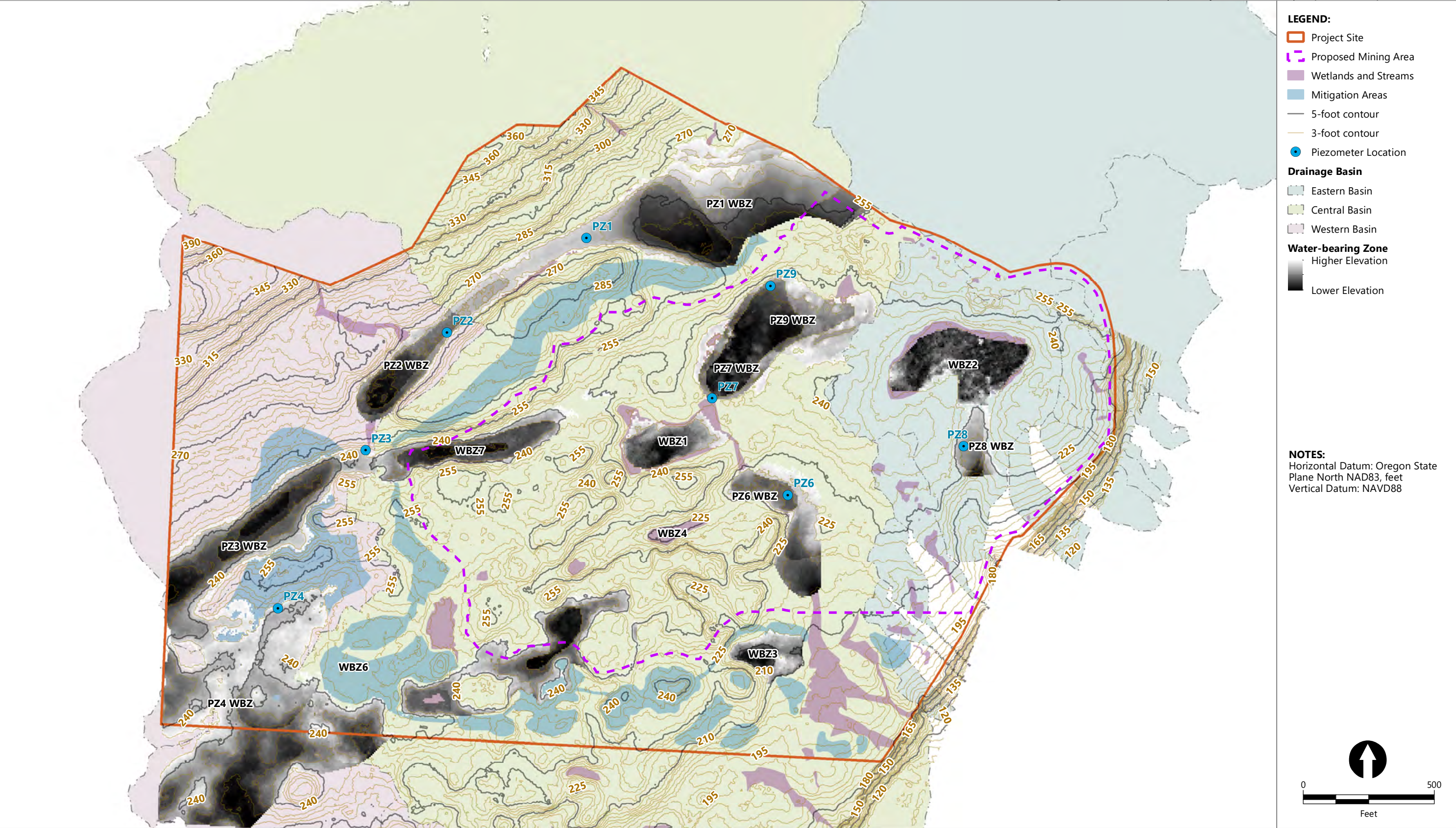
Figure A-34
March 1, 2023 Groundwater Elevation Map
 Watters Quarry Phase II Project



Publish Date: 2023/12/28, 12:21 PM | User: jfox
Filepath: \\orcas\GIS\Jobs\Knife_River_Corp_2114\Watters_Quarry\Maps\GroundwaterHydrology\AQ_WattersQuarry_GW_Analysis_Map_2023April.mxd



Figure A-35
April 1, 2023 Groundwater Elevation Map
Watters Quarry Phase II Project



Publish Date: 2023/12/28, 12:25 PM | User: jfox
Filepath: \\orcas\GIS\Jobs\Knife_River_Corp_2114\Watters_Quarry\Maps\GroundwaterHydrology\AQ_WattersQuarry_GW_Analysis_Map_2023May01.mxd



Figure A-36
May 1, 2023 Groundwater Elevation Map
 Watters Quarry Phase II Project

Appendix B

Wetland and Stream Functions and Values Assessment Report

This document is included in the JPA package as Attachment J.

Appendix C
Post-Project Wetland Functions and
Values Assessment Results and
CM Eligibility Accounting Worksheet

Table C-1
Pre- and Post-Project Wetland Functions and Values Assessment Comparisons

Groups ¹		Assessment Area 1 Wetland A (Slope)			Mitigation Site Predicted Condition Enhancement of Wetland A (Slope)			Match?
		Highest Rated Function	Score	Rating	Highest Rated Function	Score	Rating	
Hydrologic Function	Function	Water Storage and Delay	4.28	Moderate ³	Water Storage and Delay	4.36	Moderate ³	Yes
	Value		7.50	Higher		7.50	Higher	Yes
Water Quality Support	Function	Sediment Retention and Stabilization	3.12	Lower ³	Sediment Retention and Stabilization	3.16	Lower ³	Yes
	Value		7.63	Higher		7.47	Higher	Yes
Fish Habitat	Function	Anadromous Fish Habitat	0.00	Lower	Anadromous Fish Habitat	0.00	Lower	Yes
	Value		0.00	Lower		0.00	Lower	Yes
Aquatic Habitat	Function	Waterbird Nesting Habitat	7.40	Higher ²	Waterbird Nesting Habitat	7.40	Higher ²	Yes
	Value		1.72	Moderate ³		1.72	Moderate ³	Yes
Ecosystem Support	Function	Native Plant Diversity	7.25	Higher ²	Native Plant Diversity	7.85	Higher	Yes
	Value		1.67	Lower		1.70	Lower	Yes
Additional Attributes								
Carbon Sequestration	Function		4.12	Moderate ³		4.12	Moderate ³	Yes
Public Use & Recognition	Value		1.76	Lower		1.76	Lower	Yes
Wetland Sensitivity			1.14	Lower		1.35	Lower	Yes
Wetland Ecological Condition			2.99	Moderate ³		3.48	Moderate ³	Yes
Wetland Stressors			3.33	Lower ³		3.33	Lower ³	Yes

Notes:

1. Groups are a "roll-up" of individual functions and their associated values organized into thematic categories. For any assessed wetland, the specific function selected to represent a function group is the highest-rated function and the highest-rated associated value from among the group's members.
2. Rating has a Rating Break Proximity of "MH," which indicates that the rating score is within the statistical confidence interval of the break between Moderate and Higher ratings.
3. Rating has a Rating Break Proximity of "LM," which indicates that the rating score is within the statistical confidence interval of the break between Lower and Moderate ratings.

N/A: not applicable

Table C-2
Pre- and Post-Project Wetland Functions and Values Assessment Comparisons

Groups ¹		Assessment Area 2 Wetlands B and TT (Slope/Depressional Outflow)			Mitigation Site Predicted Condition Enhancement of Wetlands B and TT (Slope/Depressional Outflow)			Match?
		Highest Rated Function	Score	Rating	Highest Rated Function	Score	Rating	
Hydrologic Function	Function	Water Storage and Delay	4.25	Moderate ³	Water Storage and Delay	4.25	Moderate ³	Yes
	Value		7.50	Higher		7.50	Higher	Yes
Water Quality Support	Function	Sediment Retention and Stabilization	4.28	Moderate	Sediment Retention and Stabilization	4.28	Moderate	Yes
	Value		6.77	Higher		6.77	Higher	Yes
Fish Habitat	Function	Anadromous Fish Habitat	0.00	Lower	Anadromous Fish Habitat	0.00	Lower	Yes
	Value		0.00	Lower		0.00	Lower	Yes
Aquatic Habitat	Function	Waterbird Nesting Habitat	7.72	Higher	Waterbird Nesting Habitat	7.85	Higher	Yes
	Value		1.72	Moderate ³		1.72	Moderate ³	Yes
Ecosystem Support	Function	Organic Nutrient Export	7.28	Higher ²	Organic Nutrient Export	7.28	Higher ²	Yes
	Value		N/A			N/A		Yes
Additional Attributes								
Carbon Sequestration	Function		5.26	Moderate		5.26	Moderate	Yes
Public Use & Recognition	Value		1.82	Lower		1.82	Lower	Yes
Wetland Sensitivity			0.42	Lower		1.41	Lower	Yes
Wetland Ecological Condition			2.32	Lower ³		4.02	Moderate	Exceed
Wetland Stressors			3.33	Lower ³		3.33	Lower ³	Yes

Notes:

1. Groups are a "roll-up" of individual functions and their associated values organized into thematic categories. For any assessed wetland, the specific function selected to represent a function group is that with the highest-rated function and the highest-rated associated value from among the group's members.
 2. Rating has a Rating Break Proximity of "MH," which indicates that the rating score is within the statistical confidence interval of the break between Moderate and Higher ratings.
 3. Rating has a Rating Break Proximity of "LM," which indicates that the rating score is within the statistical confidence interval of the break between Lower and Moderate ratings.
- N/A: not applicable

Table C-3
Pre- and Post-Project Wetland Functions and Values Assessment Comparisons

Groups ¹		Assessment Area 3 Wetland C (Slope)			Mitigation Site Predicted Condition Enhancement of Wetland C (Slope)			Match?
		Highest Rated Function	Score	Rating	Highest Rated Function	Score	Rating	
Hydrologic Function	Function	Water Storage and Delay	4.62	Moderate	Water Storage and Delay	4.62	Moderate	Yes
	Value		7.50	Higher		7.50	Higher	Yes
Water Quality Support	Function	Sediment Retention and Stabilization	5.67	Moderate	Sediment Retention and Stabilization	5.67	Moderate	Yes
	Value		7.30	Higher		7.30	Higher	Yes
Fish Habitat	Function	Anadromous Fish Habitat	0.00	Lower	Anadromous Fish Habitat	0.00	Lower	Yes
	Value		0.00	Lower		0.00	Lower	Yes
Aquatic Habitat	Function	Waterbird Nesting Habitat	7.72	Higher	Waterbird Nesting Habitat	7.67	Higher	Yes
	Value		1.72	Moderate ³		1.72	Moderate ³	Yes
Ecosystem Support	Function	Organic Nutrient Export	7.13	Higher ²	Organic Nutrient Export	7.13	Higher ²	Yes
	Value		N/A			N/A		Yes
Additional Attributes								
Carbon Sequestration	Function		5.56	Moderate		5.56	Moderate	Yes
Public Use & Recognition	Value		1.82	Lower		1.82	Lower	Yes
Wetland Sensitivity			1.03	Lower		1.09	Lower	Yes
Wetland Ecological Condition			2.32	Lower ³		2.32	Lower ³	Yes
Wetland Stressors			5.00	Moderate		5.00	Moderate	Yes

Notes:

1. Groups are a "roll-up" of individual functions and their associated values organized into thematic categories. For any assessed wetland, the specific function selected to represent a function group is that with the highest-rated function and the highest-rated associated value from among the group's members.
 2. Rating has a Rating Break Proximity of "MH," which indicates that the rating score is within the statistical confidence interval of the break between Moderate and Higher ratings.
 3. Rating has a Rating Break Proximity of "LM," which indicates that the rating score is within the statistical confidence interval of the break between Lower and Moderate ratings.
- N/A: not applicable

**Table C-4
Pre- and Post-Project Wetland Functions and Values Assessment Comparisons**

Groups ¹		Assessment Area 4 Wetlands D and E (Slope)			Mitigation Site Predicted Condition Created Wetland M-3 (Slope/Depressional)			Match?
		Highest Rated Function	Score	Rating	Highest Rated Function	Score	Rating	
Hydrologic Function	Function	Water Storage and Delay	4.89	Moderate	Water Storage and Delay	10.00	Higher	Exceeds
	Value		7.50	Higher		7.50	Higher	Yes
Water Quality Support	Function	Sediment Retention and Stabilization	4.53	Moderate	Sediment Retention and Stabilization	10.00	Higher	Exceeds
	Value		6.77	Higher		6.86	Higher	Yes
Fish Habitat	Function	Anadromous Fish Habitat	0.00	Lower	Anadromous Fish Habitat	0.00	Lower	Yes
	Value		0.00	Lower		0.00	Lower	Yes
Aquatic Habitat	Function	Waterbird Nesting Habitat	8.35	Higher	Waterbird Nesting Habitat	8.38	Higher	Yes
	Value		1.72	Moderate ³		1.72	Moderate ³	Yes
Ecosystem Support	Function	Native Plant Diversity	7.70	Higher	Aquatic Invertebrate Habitat	9.62	Higher	Yes
	Value		1.98	Lower		1.20	Lower	Yes
Additional Attributes								
Carbon Sequestration	Function		3.71	Lower ³		6.25	Higher ²	Exceeds
Public Use & Recognition	Value		1.80	Lower		3.75	Lower ³	Check
Wetland Sensitivity			0.45	Lower		2.70	Moderate ³	Check
Wetland Ecological Condition			1.61	Lower		5.26	Higher ²	Exceeds
Wetland Stressors			3.33	Lower ³		5.00	Moderate	Exceeds

Notes:

1. Groups are a "roll-up" of individual functions and their associated values organized into thematic categories. For any assessed wetland, the specific function selected to represent a function group is that with the highest-rated function and the highest-rated associated value from among the group's members.
2. Rating has a Rating Break Proximity of "MH," which indicates that the rating score is within the statistical confidence interval of the break between Moderate and Higher ratings.
3. Rating has a Rating Break Proximity of "LM," which indicates that the rating score is within the statistical confidence interval of the break between Lower and Moderate ratings.

N/A: not applicable

**Table C-5
Pre- and Post-Project Wetland Functions and Values Assessment Comparisons**

Groups ¹		Assessment Area 5 Wetlands F and G (Depressional)			Mitigation Site Predicted Condition Enhancement of Wetlands F and G (Depressional)			Match?
		Highest Rated Function	Score	Rating	Highest Rated Function	Score	Rating	
Hydrologic Function	Function	Water Storage and Delay	10.00	Higher	Water Storage and Delay	10.00	Higher	Yes
	Value		7.50	Higher		7.50	Higher	Yes
Water Quality Support	Function	Sediment Retention and Stabilization	10.00	Higher	Sediment Retention and Stabilization	10.00	Higher	Yes
	Value		6.77	Higher		6.77	Higher	Yes
Fish Habitat	Function	Anadromous Fish Habitat	0.00	Lower	Anadromous Fish Habitat	0.00	Lower	Yes
	Value		0.00	Lower		0.00	Lower	Yes
Aquatic Habitat	Function	Amphibian and Reptile Habitat	7.56	Higher	Amphibian and Reptile Habitat	7.67	Higher	Yes
	Value		2.32	Lower		2.33	Lower	Yes
Ecosystem Support	Function	Pollinator Habitat	5.43	Moderate	Native Plant Diversity	8.53	Higher	Exceeds
	Value		1.03	Lower		1.79	Lower	Yes
Additional Attributes								
Carbon Sequestration	Function		5.07	Moderate		5.07	Moderate	Yes
Public Use & Recognition	Value		1.76	Lower		1.76	Lower	Yes
Wetland Sensitivity			1.35	Lower		1.97	Moderate ³	Exceeds
Wetland Ecological Condition			4.07	Moderate		5.56	Higher ²	Exceeds
Wetland Stressors			5.00	Moderate		5.00	Moderate	Yes

Notes:

1. Groups are a "roll-up" of individual functions and their associated values organized into thematic categories. For any assessed wetland, the specific function selected to represent a function group is that with the highest-rated function and the highest-rated associated value from among the group's members.
2. Rating has a Rating Break Proximity of "MH," which indicates that the rating score is within the statistical confidence interval of the break between Moderate and Higher ratings.
3. Rating has a Rating Break Proximity of "LM," which indicates that the rating score is within the statistical confidence interval of the break between Lower and Moderate ratings.

N/A: not applicable

Table C-6
Pre- and Post-Project Wetland Functions and Values Assessment Comparisons

Groups ¹		Assessment Area 6 Wetlands H, I, J, and K (Depressional)			Mitigation Site Predicted Condition Created Wetland M-2 (Depressional)			Match?
		Highest Rated Function	Score	Rating	Highest Rated Function	Score	Rating	
Hydrologic Function	Function	Water Storage and Delay	10.00	Higher	Water Storage and Delay	10.00	Higher	Yes
	Value		7.50	Higher		7.50	Higher	Yes
Water Quality Support	Function	Sediment Retention and Stabilization	10.00	Higher	Sediment Retention and Stabilization	10.00	Higher	Yes
	Value		6.77	Higher		7.17	Higher	Yes
Fish Habitat	Function	Anadromous Fish Habitat	0.00	Lower	Anadromous Fish Habitat	0.00	Lower	Yes
	Value		0.00	Lower		0.00	Lower	Yes
Aquatic Habitat	Function	Waterbird Nesting Habitat	7.74	Higher	Waterbird Feeding Habitat	9.24	Higher	Yes
	Value		1.72	Moderate ³		3.75	Moderate	Yes
Ecosystem Support	Function	Aquatic Invertebrate Habitat	6.35	Moderate ²	Native Plant Diversity	7.39	Higher ²	Exceeds
	Value		1.03	Lower		1.89	Lower	Yes
Additional Attributes								
Carbon Sequestration	Function		4.14	Moderate ³		6.32	Higher ²	Exceeds
Public Use & Recognition	Value		1.88	Lower		3.92	Lower ³	Yes
Wetland Sensitivity			1.45	Lower		2.64	Moderate ³	Exceeds
Wetland Ecological Condition			1.21	Lower		5.47	Higher ²	Exceeds
Wetland Stressors			5.00	Moderate		5.00	Moderate	Yes

Notes:

1. Groups are a "roll-up" of individual functions and their associated values organized into thematic categories. For any assessed wetland, the specific function selected to represent a function group is that with the highest-rated function and the highest-rated associated value from among the group's members.
2. Rating has a Rating Break Proximity of "MH," which indicates that the rating score is within the statistical confidence interval of the break between Moderate and Higher ratings.
3. Rating has a Rating Break Proximity of "LM," which indicates that the rating score is within the statistical confidence interval of the break between Lower and Moderate ratings.

N/A: not applicable

Table C-7
Pre- and Post-Project Wetland Functions and Values Assessment Comparisons

Groups ¹		Assessment Area 7 Wetland M (Depressional Outflow)			Mitigation Site Predicted Condition Created Wetland M-1 (Slope/Depressional Outflow)			Match?
		Highest Rated Function	Score	Rating	Highest Rated Function	Score	Rating	
Hydrologic Function	Function	Water Storage and Delay	3.08	Lower ³	Water Storage and Delay	5.47	Moderate	Exceeds
	Value		7.50	Higher		7.50	Higher	Yes
Water Quality Support	Function	Sediment Retention and Stabilization	4.01	Moderate ³	Sediment Retention and Stabilization	4.88	Moderate	Yes
	Value		7.30	Higher		7.52	Higher	Yes
Fish Habitat	Function	Anadromous Fish Habitat	0.00	Lower	Anadromous Fish Habitat	0.00	Lower	Yes
	Value		0.00	Lower		0.00	Lower	Yes
Aquatic Habitat	Function	Waterbird Nesting Habitat	8.20	Higher	Waterbird Nesting Habitat	8.24	Higher	Yes
	Value		1.72	Moderate ³		1.72	Moderate ³	Yes
Ecosystem Support	Function	Native Plant Diversity	8.12	Higher	Native Plant Diversity	8.85	Higher	Yes
	Value		10.00	Higher		10.00	Higher	Yes
Additional Attributes								
Carbon Sequestration	Function		3.96	Moderate ³		4.92	Moderate	Yes
Public Use & Recognition	Value		1.81	Lower		3.76	Lower ³	Yes
Wetland Sensitivity			5.47	Higher		6.30	Higher	Yes
Wetland Ecological Condition			3.53	Moderate ³		5.06	Moderate ²	Yes
Wetland Stressors			3.33	Lower ³		3.33	Lower ³	Yes

Notes:

1. Groups are a "roll-up" of individual functions and their associated values organized into thematic categories. For any assessed wetland, the specific function selected to represent a function group is that with the highest-rated function and the highest-rated associated value from among the group's members.
2. Rating has a Rating Break Proximity of "MH," which indicates that the rating score is within the statistical confidence interval of the break between Moderate and Higher ratings.
3. Rating has a Rating Break Proximity of "LM," which indicates that the rating score is within the statistical confidence interval of the break between Lower and Moderate ratings.

N/A: not applicable

Table C-8
Pre- and Post-Project Wetland Functions and Values Assessment Comparisons

Groups ¹		Assessment Area 8 Wetland N (Depressional Outflow)			Mitigation Site Predicted Condition Created Wetland M-3 (Slope/Depressional)			Match?
		Highest Rated Function	Score	Rating	Highest Rated Function	Score	Rating	
Hydrologic Function	Function	Water Storage and Delay	4.19	Moderate ³	Water Storage and Delay	10.00	Higher	Exceeds
	Value		7.50	Higher		7.50	Higher	Yes
Water Quality Support	Function	Sediment Retention and Stabilization	3.84	Moderate ³	Sediment Retention and Stabilization	10.00	Higher	Exceeds
	Value		6.77	Higher		6.86	Higher	Yes
Fish Habitat	Function	Anadromous Fish Habitat	0.00	Lower	Anadromous Fish Habitat	0.00	Lower	Yes
	Value		0.00	Lower		0.00	Lower	Yes
Aquatic Habitat	Function	Waterbird Nesting Habitat	8.16	Higher	Waterbird Nesting Habitat	8.38	Higher	Yes
	Value		1.72	Moderate ³		1.72	Moderate ³	Yes
Ecosystem Support	Function	Organic Nutrient Export	6.94	Higher ²	Aquatic Invertebrate Habitat	9.62	Higher	Yes
	Value		N/A			1.20	Lower	N/A
Additional Attributes								
Carbon Sequestration	Function		5.16	Moderate		6.25	Higher ²	Exceeds
Public Use & Recognition	Value		1.81	Lower		3.75	Lower ³	Yes
Wetland Sensitivity			0.67	Lower		2.70	Moderate ³	Exceeds
Wetland Ecological Condition			3.43	Moderate ³		5.26	Higher ²	Exceeds
Wetland Stressors			3.33	Lower ³		5.00	Moderate	Exceeds

Notes:

1. Groups are a "roll-up" of individual functions and their associated values organized into thematic categories. For any assessed wetland, the specific function selected to represent a function group is that with the highest-rated function and the highest-rated associated value from among the group's members.
 2. Rating has a Rating Break Proximity of "MH," which indicates that the rating score is within the statistical confidence interval of the break between Moderate and Higher ratings.
 3. Rating has a Rating Break Proximity of "LM," which indicates that the rating score is within the statistical confidence interval of the break between Lower and Moderate ratings.
- N/A: not applicable

Table C-9
Pre- and Post-Project Wetland Functions and Values Assessment Comparisons

Groups ¹		Assessment Area 9 Wetlands L, SS, and XX (Depressional/Depressional Outflow)			Mitigation Site Predicted Condition Created Wetlands M-4 through M-10 (Depressional)			Match?
		Highest Rated Function	Score	Rating	Highest Rated Function	Score	Rating	
Hydrologic Function	Function	Water Storage and Delay	3.97	Lower ³	Water Storage and Delay	10.00	Higher	Exceeds
	Value		7.50	Higher		7.50	Higher	Yes
Water Quality Support	Function	Sediment Retention and Stabilization	2.78	Lower	Sediment Retention and Stabilization	10.00	Higher	Exceeds
	Value		6.77	Higher		7.42	Higher	Yes
Fish Habitat	Function	Anadromous Fish Habitat	0.00	Lower	Anadromous Fish Habitat	0.00	Lower	Yes
	Value		0.00	Lower		0.00	Lower	Yes
Aquatic Habitat	Function	Amphibian and Reptile Habitat	7.86	Higher	Waterbird Nesting Habitat	7.74	Higher	Yes
	Value		1.11	Lower		1.72	Moderate ³	Exceeds
Ecosystem Support	Function	Organic Nutrient Export	7.48	Higher	Native Plant Diversity	7.48	Higher ²	Yes
	Value		N/A			10.00	Higher	N/A
Additional Attributes								
Carbon Sequestration	Function		3.24	Lower		3.80	Lower	Yes
Public Use & Recognition	Value		1.88	Lower		3.82	Lower ³	Yes
Wetland Sensitivity			4.53	Higher ²		5.56	Higher	Yes
Wetland Ecological Condition			0.72	Lower		2.99	Moderate ³	Exceeds
Wetland Stressors			3.33	Lower ³		5.00	Moderate	Exceeds

Notes:

1. Groups are a "roll-up" of individual functions and their associated values organized into thematic categories. For any assessed wetland, the specific function selected to represent a function group is that with the highest-rated function and the highest-rated associated value from among the group's members.
 2. Rating has a Rating Break Proximity of "MH," which indicates that the rating score is within the statistical confidence interval of the break between Moderate and Higher ratings.
 3. Rating has a Rating Break Proximity of "LM," which indicates that the rating score is within the statistical confidence interval of the break between Lower and Moderate ratings.
- N/A: not applicable

Table C-10
Pre- and Post-Project Wetland Functions and Values Assessment Comparisons

Groups ¹		Assessment Area 10 Wetlands O through T, QQ, and RR (Depressional/Depressional Outflow)			Mitigation Site Predicted Condition Created Wetlands M-4 through M-10 (Depressional)			Match?
		Highest Rated Function	Score	Rating	Highest Rated Function	Score	Rating	
Hydrologic Function	Function	Water Storage and Delay	10.00	Higher	Water Storage and Delay	10.00	Higher	Yes
	Value		7.50	Higher		7.50	Higher	Yes
Water Quality Support	Function	Sediment Retention and Stabilization	10.00	Higher	Sediment Retention and Stabilization	10.00	Higher	Yes
	Value		6.77	Higher		7.42	Higher	Yes
Fish Habitat	Function	Anadromous Fish Habitat	0.00	Lower	Anadromous Fish Habitat	0.00	Lower	Yes
	Value		0.00	Lower		0.00	Lower	Yes
Aquatic Habitat	Function	Amphibian and Reptile Habitat	7.97	Higher	Waterbird Nesting Habitat	7.74	Higher	Yes
	Value		1.11	Lower		1.72	Moderate ³	Exceeds
Ecosystem Support	Function	Native Plant Diversity	6.50	Moderate ²	Native Plant Diversity	7.48	Higher ²	Exceeds
	Value		10.00	Higher		10.00	Higher	Yes
Additional Attributes								
Carbon Sequestration	Function		3.22	Lower		3.80	Lower	Yes
Public Use & Recognition	Value		1.88	Lower		3.82	Lower ³	Yes
Wetland Sensitivity			4.78	Higher ²		5.56	Higher	Yes
Wetland Ecological Condition			0.72	Lower		2.99	Moderate ³	Exceeds
Wetland Stressors			5.00	Moderate		5.00	Moderate	Yes

Notes:

1. Groups are a "roll-up" of individual functions and their associated values organized into thematic categories. For any assessed wetland, the specific function selected to represent a function group is that with the highest-rated function and the highest-rated associated value from among the group's members.
2. Rating has a Rating Break Proximity of "MH," which indicates that the rating score is within the statistical confidence interval of the break between Moderate and Higher ratings.
3. Rating has a Rating Break Proximity of "LM," which indicates that the rating score is within the statistical confidence interval of the break between Lower and Moderate ratings.

N/A: not applicable

Table C-11
Pre- and Post-Project Wetland Functions and Values Assessment Comparisons

Groups ¹		Assessment Area 11 Wetland U (Depressional)			Mitigation Site Predicted Condition Wetland U (Depressional)			Match?
		Highest Rated Function	Score	Rating	Highest Rated Function	Score	Rating	
Hydrologic Function	Function	Water Storage and Delay	4.25	Moderate ³	Water Storage and Delay	4.14	Moderate ³	Yes
	Value		7.50	Higher		7.50	Higher	Yes
Water Quality Support	Function	Sediment Retention and Stabilization	2.88	Lower	Sediment Retention and Stabilization	2.88	Lower	Yes
	Value		6.77	Higher		7.17	Higher	Yes
Fish Habitat	Function	Anadromous Fish Habitat	0.00	Lower	Anadromous Fish Habitat	0.00	Lower	Yes
	Value		0.00	Lower		0.00	Lower	Yes
Aquatic Habitat	Function	Amphibian and Reptile Habitat	7.89	Higher	Amphibian and Reptile Habitat	7.85	Higher	Yes
	Value		1.11	Lower		1.11	Lower	Yes
Ecosystem Support	Function	Organic Nutrient Export	7.19	Higher ²	Organic Nutrient Export	7.19	Higher ²	Yes
	Value		N/A			N/A		Yes
Additional Attributes								
Carbon Sequestration	Function		2.75	Lower		2.75	Lower	Yes
Public Use & Recognition	Value		1.88	Lower		1.88	Lower	Yes
Wetland Sensitivity			4.43	Moderate ²		4.47	Higher ²	Exceeds
Wetland Ecological Condition			0.72	Lower		0.72	Lower	Yes
Wetland Stressors			3.33	Lower ³		3.33	Lower ³	Yes

Notes:

1. Groups are a "roll-up" of individual functions and their associated values organized into thematic categories. For any assessed wetland, the specific function selected to represent a function group is that with the highest-rated function and the highest-rated associated value from among the group's members.
 2. Rating has a Rating Break Proximity of "MH," which indicates that the rating score is within the statistical confidence interval of the break between Moderate and Higher ratings.
 3. Rating has a Rating Break Proximity of "LM," which indicates that the rating score is within the statistical confidence interval of the break between Lower and Moderate ratings.
- N/A: not applicable

Table C-12
Pre- and Post-Project Wetland Functions and Values Assessment Comparisons

Groups ¹		Assessment Area 12 Wetland Z (Depressional)			Mitigation Site Predicted Condition Wetland Z (Depressional)			Match?
		Highest Rated Function	Score	Rating	Highest Rated Function	Score	Rating	
Hydrologic Function	Function	Water Storage and Delay	10.00	Higher	Water Storage and Delay	10.00	Higher	Yes
	Value		7.50	Higher		7.50	Higher	Yes
Water Quality Support	Function	Sediment Retention and Stabilization	10.00	Higher	Sediment Retention and Stabilization	10.00	Higher	Yes
	Value		6.77	Higher		6.96	Higher	Yes
Fish Habitat	Function	Anadromous Fish Habitat	0.00	Lower	Anadromous Fish Habitat	0.00	Lower	Yes
	Value		0.00	Lower		0.00	Lower	Yes
Aquatic Habitat	Function	Waterbird Nesting Habitat	7.52	Higher	Waterbird Nesting Habitat	7.45	Higher ²	Yes
	Value		1.72	Moderate ³		1.72	Moderate ³	Yes
Ecosystem Support	Function	Native Plant Diversity	6.83	Higher ²	Native Plant Diversity	6.66	Higher ²	Yes
	Value		1.49	Lower		1.48	Lower	Yes
Additional Attributes								
Carbon Sequestration	Function		5.59	Moderate		5.59	Moderate	Yes
Public Use & Recognition	Value		1.88	Lower		1.88	Lower	Yes
Wetland Sensitivity			2.11	Lower ³		2.15	Lower ³	Yes
Wetland Ecological Condition			2.99	Moderate ³		2.99	Moderate ³	Yes
Wetland Stressors			5.00	Moderate		5.00	Moderate	Yes

Notes:

1. Groups are a "roll-up" of individual functions and their associated values organized into thematic categories. For any assessed wetland, the specific function selected to represent a function group is that with the highest-rated function and the highest-rated associated value from among the group's members.
2. Rating has a Rating Break Proximity of "MH," which indicates that the rating score is within the statistical confidence interval of the break between Moderate and Higher ratings.
3. Rating has a Rating Break Proximity of "LM," which indicates that the rating score is within the statistical confidence interval of the break between Lower and Moderate ratings.

N/A: not applicable

Table C-13
Pre- and Post-Project Wetland Functions and Values Assessment Comparisons

Groups ¹		Assessment Area 13 Wetland AA (Depressional)			Mitigation Site Predicted Condition Created Wetland M-3 (Slope/Depressional)			Match?
		Highest Rated Function	Score	Rating	Highest Rated Function	Score	Rating	
Hydrologic Function	Function	Water Storage and Delay	10.00	Higher	Water Storage and Delay	10.00	Higher	Yes
	Value		7.50	Higher		7.50	Higher	Yes
Water Quality Support	Function	Sediment Retention and Stabilization	10.00	Higher	Sediment Retention and Stabilization	10.00	Higher	Yes
	Value		6.98	Higher		6.86	Higher	Yes
Fish Habitat	Function	Anadromous Fish Habitat	0.00	Lower	Anadromous Fish Habitat	0.00	Lower	Yes
	Value		0.00	Lower		0.00	Lower	Yes
Aquatic Habitat	Function	Waterbird Nesting Habitat	7.56	Higher	Waterbird Nesting Habitat	8.38	Higher	Yes
	Value		1.72	Moderate ³		1.72	Moderate ³	Yes
Ecosystem Support	Function	Aquatic Invertebrate Habitat	7.38	Higher ²	Aquatic Invertebrate Habitat	9.62	Higher	Yes
	Value		1.09	Lower		1.20	Lower	Yes
Additional Attributes								
Carbon Sequestration	Function		5.93	Moderate ²		6.25	Higher ²	Exceeds
Public Use & Recognition	Value		1.88	Lower		3.75	Lower ³	Yes
Wetland Sensitivity			2.75	Moderate ³		2.70	Moderate ³	Yes
Wetland Ecological Condition			3.53	Moderate ³		5.26	Higher ²	Exceeds
Wetland Stressors			5.00	Moderate		5.00	Moderate	Yes

Notes:

1. Groups are a "roll-up" of individual functions and their associated values organized into thematic categories. For any assessed wetland, the specific function selected to represent a function group is that with the highest-rated function and the highest-rated associated value from among the group's members.
2. Rating has a Rating Break Proximity of "MH," which indicates that the rating score is within the statistical confidence interval of the break between Moderate and Higher ratings.
3. Rating has a Rating Break Proximity of "LM," which indicates that the rating score is within the statistical confidence interval of the break between Lower and Moderate ratings.

N/A: not applicable

Table C-14
Pre- and Post-Project Wetland Functions and Values Assessment Comparisons

Groups ¹		Assessment Area 14 Wetland BB (Depressional)			Mitigation Site Predicted Condition Created Wetland M-3 (Slope/Depressional)			Match?
		Highest Rated Function	Score	Rating	Highest Rated Function	Score	Rating	
Hydrologic Function	Function	Water Storage and Delay	10.00	Higher	Water Storage and Delay	10.00	Higher	Yes
	Value		7.50	Higher		7.50	Higher	Yes
Water Quality Support	Function	Sediment Retention and Stabilization	10.00	Higher	Sediment Retention and Stabilization	10.00	Higher	Yes
	Value		6.98	Higher		6.86	Higher	Yes
Fish Habitat	Function	Anadromous Fish Habitat	0.00	Lower	Anadromous Fish Habitat	0.00	Lower	Yes
	Value		0.00	Lower		0.00	Lower	Yes
Aquatic Habitat	Function	Waterbird Nesting Habitat	8.27	Higher	Waterbird Nesting Habitat	8.38	Higher	Yes
	Value		1.72	Moderate ³		1.72	Moderate ³	Yes
Ecosystem Support	Function	Aquatic Invertebrate Habitat	8.69	Higher	Aquatic Invertebrate Habitat	9.62	Higher	Yes
	Value		1.07	Lower		1.20	Lower	Yes
Additional Attributes								
Carbon Sequestration	Function		4.90	Moderate		6.25	Higher ²	Exceeds
Public Use & Recognition	Value		1.88	Lower		3.75	Lower ³	Yes
Wetland Sensitivity			2.19	Lower ³		2.70	Moderate ³	Exceeds
Wetland Ecological Condition			2.44	Lower ³		5.26	Higher ²	Exceeds
Wetland Stressors			5.00	Moderate		5.00	Moderate	Yes

Notes:

1. Groups are a "roll-up" of individual functions and their associated values organized into thematic categories. For any assessed wetland, the specific function selected to represent a function group is that with the highest-rated function and the highest-rated associated value from among the group's members.
2. Rating has a Rating Break Proximity of "MH," which indicates that the rating score is within the statistical confidence interval of the break between Moderate and Higher ratings.
3. Rating has a Rating Break Proximity of "LM," which indicates that the rating score is within the statistical confidence interval of the break between Lower and Moderate ratings.

N/A: not applicable

Table C-15
Pre- and Post-Project Wetland Functions and Values Assessment Comparisons

Groups ¹		Assessment Area 15 Wetland CC (Depressional)			Mitigation Site Predicted Condition Created Wetland M-3 (Slope/Depressional)			Match?
		Highest Rated Function	Score	Rating	Highest Rated Function	Score	Rating	
Hydrologic Function	Function	Water Storage and Delay	10.00	Higher	Water Storage and Delay	10.00	Higher	Yes
	Value		7.50	Higher		7.50	Higher	Yes
Water Quality Support	Function	Sediment Retention and Stabilization	10.00	Higher	Sediment Retention and Stabilization	10.00	Higher	Yes
	Value		6.98	Higher		6.86	Higher	Yes
Fish Habitat	Function	Anadromous Fish Habitat	0.00	Lower	Anadromous Fish Habitat	0.00	Lower	Yes
	Value		0.00	Lower		0.00	Lower	Yes
Aquatic Habitat	Function	Waterbird Nesting Habitat	7.97	Higher	Waterbird Nesting Habitat	8.38	Higher	Yes
	Value		1.72	Moderate ³		1.72	Moderate ³	Yes
Ecosystem Support	Function	Aquatic Invertebrate Habitat	8.24	Higher	Aquatic Invertebrate Habitat	9.62	Higher	Yes
	Value		1.11	Lower		1.20	Lower	Yes
Additional Attributes								
Carbon Sequestration	Function		4.75	Moderate		6.25	Higher ²	Exceeds
Public Use & Recognition	Value		1.81	Lower		3.75	Lower ³	Yes
Wetland Sensitivity			2.90	Moderate		2.70	Moderate ³	Yes
Wetland Ecological Condition			2.74	Lower ³		5.26	Higher ²	Exceeds
Wetland Stressors			5.00	Moderate		5.00	Moderate	Yes

Notes:

1. Groups are a "roll-up" of individual functions and their associated values organized into thematic categories. For any assessed wetland, the specific function selected to represent a function group is that with the highest-rated function and the highest-rated associated value from among the group's members.
2. Rating has a Rating Break Proximity of "MH," which indicates that the rating score is within the statistical confidence interval of the break between Moderate and Higher ratings.
3. Rating has a Rating Break Proximity of "LM," which indicates that the rating score is within the statistical confidence interval of the break between Lower and Moderate ratings.

N/A: not applicable

Table C-16
Pre- and Post-Project Wetland Functions and Values Assessment Comparisons

Groups ¹		Assessment Area 16 Wetland DD (Depressional)			Mitigation Site Predicted Condition Wetland DD (Depressional)			Match?
		Highest Rated Function	Score	Rating	Highest Rated Function	Score	Rating	
Hydrologic Function	Function	Water Storage and Delay	10.00	Higher	Water Storage and Delay	10.00	Higher	Yes
	Value		7.50	Higher		7.50	Higher	Yes
Water Quality Support	Function	Sediment Retention and Stabilization	10.00	Higher	Sediment Retention and Stabilization	10.00	Higher	Yes
	Value		6.98	Higher		7.05	Higher	Yes
Fish Habitat	Function	Anadromous Fish Habitat	0.00	Lower	Anadromous Fish Habitat	0.00	Lower	Yes
	Value		0.00	Lower		0.00	Lower	Yes
Aquatic Habitat	Function	Waterbird Nesting Habitat	7.81	Higher	Waterbird Nesting Habitat	7.85	Higher	Yes
	Value		1.72	Moderate ³		1.72	Moderate ³	Yes
Ecosystem Support	Function	Aquatic Invertebrate Habitat	7.85	Higher	Aquatic Invertebrate Habitat	7.50	Higher ²	Yes
	Value		1.09	Lower		1.08	Lower	Yes
Additional Attributes								
Carbon Sequestration	Function		4.71	Moderate		4.71	Moderate	Yes
Public Use & Recognition	Value		1.88	Lower		1.88	Lower	Yes
Wetland Sensitivity			2.02	Lower ³		2.04	Lower ³	Yes
Wetland Ecological Condition			3.04	Moderate ³		3.04	Moderate ³	Yes
Wetland Stressors			5.00	Moderate		5.00	Moderate	Yes

Notes:

1. Groups are a "roll-up" of individual functions and their associated values organized into thematic categories. For any assessed wetland, the specific function selected to represent a function group is that with the highest-rated function and the highest-rated associated value from among the group's members.
2. Rating has a Rating Break Proximity of "MH," which indicates that the rating score is within the statistical confidence interval of the break between Moderate and Higher ratings.
3. Rating has a Rating Break Proximity of "LM," which indicates that the rating score is within the statistical confidence interval of the break between Lower and Moderate ratings.

N/A: not applicable

Table C-17
Pre- and Post-Project Wetland Functions and Values Assessment Comparisons

Groups ¹		Assessment Area 17 Wetlands EE and FF (Depressional)			Mitigation Site Predicted Condition Wetlands EE and FF (Depressional)			Match?
		Highest Rated Function	Score	Rating	Highest Rated Function	Score	Rating	
Hydrologic Function	Function	Water Storage and Delay	10.00	Higher	Water Storage and Delay	10.00	Higher	Yes
	Value		7.50	Higher		7.50	Higher	Yes
Water Quality Support	Function	Sediment Retention and Stabilization	10.00	Higher	Sediment Retention and Stabilization	10.00	Higher	Yes
	Value		6.98	Higher		6.86	Higher	Yes
Fish Habitat	Function	Anadromous Fish Habitat	0.00	Lower	Anadromous Fish Habitat	0.00	Lower	Yes
	Value		0.00	Lower		0.00	Lower	Yes
Aquatic Habitat	Function	Waterbird Nesting Habitat	7.99	Higher	Waterbird Nesting Habitat	7.96	Higher	Yes
	Value		1.72	Moderate ³		1.72	Moderate ³	Yes
Ecosystem Support	Function	Water Cooling	9.83	Higher	Water Cooling	9.83	Higher	Yes
	Value		0.00	Lower		0.00	Lower	Yes
Additional Attributes								
Carbon Sequestration	Function		4.98	Moderate		4.98	Moderate	Yes
Public Use & Recognition	Value		1.88	Lower		1.88	Lower	Yes
Wetland Sensitivity			2.27	Moderate ³		2.27	Moderate ³	Yes
Wetland Ecological Condition			1.46	Lower		1.46	Lower	Yes
Wetland Stressors			5.00	Moderate		5.00	Moderate	Yes

Notes:

1. Groups are a "roll-up" of individual functions and their associated values organized into thematic categories. For any assessed wetland, the specific function selected to represent a function group is that with the highest-rated function and the highest-rated associated value from among the group's members.
2. Rating has a Rating Break Proximity of "MH," which indicates that the rating score is within the statistical confidence interval of the break between Moderate and Higher ratings.
3. Rating has a Rating Break Proximity of "LM," which indicates that the rating score is within the statistical confidence interval of the break between Lower and Moderate ratings.

N/A: not applicable

Table C-18
Pre- and Post-Project Wetland Functions and Values Assessment Comparisons

Groups ¹		Assessment Area 18 Wetland PP (Depressional Outflow)			Mitigation Site Predicted Condition Wetland PP (Depressional Outflow)			Match?
		Highest Rated Function	Score	Rating	Highest Rated Function	Score	Rating	
Hydrologic Function	Function	Water Storage and Delay	4.37	Moderate ³	Water Storage and Delay	4.29	Moderate ³	Yes
	Value		7.50	Higher		7.50	Higher	Yes
Water Quality Support	Function	Sediment Retention and Stabilization	3.11	Lower ³	Sediment Retention and Stabilization	3.06	Lower ³	Yes
	Value		7.50	Higher		7.80	Higher	Yes
Fish Habitat	Function	Anadromous Fish Habitat	0.00	Lower	Anadromous Fish Habitat	0.00	Lower	Yes
	Value		0.00	Lower		0.00	Lower	Yes
Aquatic Habitat	Function	Amphibian and Reptile Habitat	7.89	Higher	Amphibian and Reptile Habitat	7.87	Higher	Yes
	Value		1.11	Lower		1.11	Lower	Yes
Ecosystem Support	Function	Native Plant Diversity	6.66	Higher ²	Organic Nutrient Export	7.47	Higher	Yes
	Value		10.00	Higher		N/A		N/A
Additional Attributes								
Carbon Sequestration	Function		2.75	Lower		2.75	Lower	Yes
Public Use & Recognition	Value		1.88	Lower		1.88	Lower	Yes
Wetland Sensitivity			4.43	Moderate ²		4.43	Moderate ²	Yes
Wetland Ecological Condition			0.72	Lower		0.72	Lower	Yes
Wetland Stressors			3.33	Lower ³		3.33	Lower ³	Yes

Notes:

1. Groups are a "roll-up" of individual functions and their associated values organized into thematic categories. For any assessed wetland, the specific function selected to represent a function group is that with the highest-rated function and the highest-rated associated value from among the group's members.
 2. Rating has a Rating Break Proximity of "MH," which indicates that the rating score is within the statistical confidence interval of the break between Moderate and Higher ratings.
 3. Rating has a Rating Break Proximity of "LM," which indicates that the rating score is within the statistical confidence interval of the break between Lower and Moderate ratings.
- N/A: not applicable

Table C-19
Pre- and Post-Project Wetland Functions and Values Assessment Comparisons

Groups ¹		Assessment Area 19 Wetland YY (Depressional Outflow)			Mitigation Site Predicted Condition Created Wetland M-2 (Depressional)			Match?
		Highest Rated Function	Score	Rating	Highest Rated Function	Score	Rating	
Hydrologic Function	Function	Water Storage and Delay	4.41	Moderate ³	Water Storage and Delay	10.00	Higher	Exceeds
	Value		7.50	Higher		7.50	Higher	Yes
Water Quality Support	Function	Sediment Retention and Stabilization	3.10	Lower ³	Sediment Retention and Stabilization	10.00	Higher	Exceeds
	Value		6.98	Higher		7.17	Higher	Exceeds
Fish Habitat	Function	Anadromous Fish Habitat	0.00	Lower	Anadromous Fish Habitat	0.00	Lower	Yes
	Value		0.00	Lower		0.00	Lower	Yes
Aquatic Habitat	Function	Waterbird Nesting Habitat	7.87	Higher	Waterbird Feeding Habitat	9.24	Higher	Yes
	Value		1.72	Moderate ³		3.75	Moderate	Yes
Ecosystem Support	Function	Organic Nutrient Export	5.66	Moderate	Native Plant Diversity	7.39	Higher ²	Exceeds
	Value		N/A			1.89	Lower	N/A
Additional Attributes								
Carbon Sequestration	Function		2.89	Lower		6.32	Higher ²	Exceeds
Public Use & Recognition	Value		1.88	Lower		3.92	Lower ³	Yes
Wetland Sensitivity			0.30	Lower		2.64	Moderate ³	Exceeds
Wetland Ecological Condition			2.25	Lower		5.47	Higher ²	Exceeds
Wetland Stressors			3.33	Lower ³		5.00	Moderate	Exceeds

Notes:

1. Groups are a "roll-up" of individual functions and their associated values organized into thematic categories. For any assessed wetland, the specific function selected to represent a function group is that with the highest-rated function and the highest-rated associated value from among the group's members.
 2. Rating has a Rating Break Proximity of "MH," which indicates that the rating score is within the statistical confidence interval of the break between Moderate and Higher ratings.
 3. Rating has a Rating Break Proximity of "LM," which indicates that the rating score is within the statistical confidence interval of the break between Lower and Moderate ratings.
- N/A: not applicable

Table C-20
Pre- and Post-Project Wetland Functions and Values Assessment Comparisons

Groups ¹		Assessment Area 20 Wetland ZZ (Depressional)			Mitigation Site Predicted Condition Created Wetland M-3 (Slope/Depressional)			Match?
		Highest Rated Function	Score	Rating	Highest Rated Function	Score	Rating	
Hydrologic Function	Function	Water Storage and Delay	10.00	Higher	Water Storage and Delay	10.00	Higher	Yes
	Value		7.50	Higher		7.50	Higher	Yes
Water Quality Support	Function	Sediment Retention and Stabilization	10.00	Higher	Sediment Retention and Stabilization	10.00	Higher	Yes
	Value		6.98	Higher		6.86	Higher	Yes
Fish Habitat	Function	Anadromous Fish Habitat	0.00	Lower	Anadromous Fish Habitat	0.00	Lower	Yes
	Value		0.00	Lower		0.00	Lower	Yes
Aquatic Habitat	Function	Waterbird Nesting Habitat	7.32	Higher ²	Waterbird Nesting Habitat	8.38	Higher	Yes
	Value		1.72	Moderate ³		1.72	Moderate ³	Yes
Ecosystem Support	Function	Aquatic Invertebrate Habitat	7.39	Higher ²	Aquatic Invertebrate Habitat	9.62	Higher	Yes
	Value		1.06	Lower		1.20	Lower	Yes
Additional Attributes								
Carbon Sequestration	Function		4.47	Moderate		6.25	Higher ²	Exceeds
Public Use & Recognition	Value		1.88	Lower		3.75	Lower ³	Yes
Wetland Sensitivity			2.67	Moderate ³		2.70	Moderate ³	Yes
Wetland Ecological Condition			2.94	Moderate ³		5.26	Higher ²	Exceeds
Wetland Stressors			5.00	Moderate		5.00	Moderate	Yes

Notes:

1. Groups are a "roll-up" of individual functions and their associated values organized into thematic categories. For any assessed wetland, the specific function selected to represent a function group is that with the highest-rated function and the highest-rated associated value from among the group's members.
2. Rating has a Rating Break Proximity of "MH," which indicates that the rating score is within the statistical confidence interval of the break between Moderate and Higher ratings.
3. Rating has a Rating Break Proximity of "LM," which indicates that the rating score is within the statistical confidence interval of the break between Lower and Moderate ratings.

N/A: not applicable

Table C-21
Pre- and Post-Project Wetland Functions and Values Assessment Comparisons

Groups ¹		Assessment Area 21 Wetland OO (Depressional Outflow)			Mitigation Site Predicted Condition Wetland OO (Depressional Outflow)			Match?
		Highest Rated Function	Score	Rating	Highest Rated Function	Score	Rating	
Hydrologic Function	Function	Water Storage and Delay	4.33	Moderate ³	Water Storage and Delay	4.35	Moderate ³	Yes
	Value		7.50	Higher		7.50	Higher	Yes
Water Quality Support	Function	Sediment Retention and Stabilization	3.07	Lower ³	Sediment Retention and Stabilization	3.12	Lower ³	Yes
	Value		6.77	Higher		7.05	Higher	Yes
Fish Habitat	Function	Anadromous Fish Habitat	0.00	Lower	Anadromous Fish Habitat	0.00	Lower	Yes
	Value		0.00	Lower		0.00	Lower	Yes
Aquatic Habitat	Function	Waterbird Nesting Habitat	7.79	Higher	Waterbird Nesting Habitat	7.90	Higher	Yes
	Value		1.72	Moderate ³		1.72	Moderate ³	Yes
Ecosystem Support	Function	Organic Nutrient Export	6.12	Moderate ²	Organic Nutrient Export	6.08	Moderate	Yes
	Value		N/A			N/A		Yes
Additional Attributes								
Carbon Sequestration	Function		2.95	Lower ³		2.87	Lower	Yes
Public Use & Recognition	Value		1.88	Lower		1.88	Lower	Yes
Wetland Sensitivity			4.33	Moderate ²		4.33	Moderate ²	Yes
Wetland Ecological Condition			1.51	Lower		1.51	Lower	Yes
Wetland Stressors			3.33	Lower ³		3.33	Lower ³	Yes

Notes:

1. Groups are a "roll-up" of individual functions and their associated values organized into thematic categories. For any assessed wetland, the specific function selected to represent a function group is that with the highest-rated function and the highest-rated associated value from among the group's members.
 2. Rating has a Rating Break Proximity of "MH," which indicates that the rating score is within the statistical confidence interval of the break between Moderate and Higher ratings.
 3. Rating has a Rating Break Proximity of "LM," which indicates that the rating score is within the statistical confidence interval of the break between Lower and Moderate ratings.
- N/A: not applicable

Table C-22
Pre- and Post-Project Stream Functions and Values Assessment Comparisons

Groups ¹		Stream Assessment Area 1 Intermittent Stream B			Stream Assessment Area 2 Tributary to Intermittent Stream B			Stream Assessment Area 3 Intermittent Stream D ²			Stream Assessment Area 4 Perennial Stream 1-A			Mitigation Site Predicted Condition Created Perennial Stream MS-1 ³			Match?
		Highest Rated Function	Score	Rating	Highest Rated Function	Score	Rating	Highest Rated Function	Score	Rating	Highest Rated Function	Score	Rating	Highest Rated Function	Score	Rating	
Hydrologic Function	Function	Flow Variation	8.75	Higher	Flow Variation	7.21	Higher	Flow Variation	6.67	Moderate	Flow Variation	8.34	Higher	Flow Variation	7.26	Higher	Yes
	Value		8.33	Higher		8.33	Higher		9.50	Higher		8.33	Higher		7.50	Higher	Yes
Geomorphic Function	Function	Sediment Mobility	8.50	Higher	Sediment Continuity	8.55	Higher	Sediment Continuity	10.00	Higher	Sediment Mobility	8.39	Higher	Sediment Mobility	7.16	Higher	Yes
	Value		5.00	Moderate		3.25	Lower		3.48	Moderate		5.00	Moderate		7.50	Higher	Yes
Biologic Function	Function	Sustain Trophic Structure	7.06	Higher	Sustain Trophic Structure	5.77	Moderate	Sustain Trophic Structure	5.44	Moderate	Sustain Trophic Structure	6.08	Moderate	Sustain Trophic Structure	8.73	Higher	Yes
	Value		5.11	Moderate		5.11	Moderate		4.61	Moderate		5.11	Moderate		6.71	Moderate	Yes
Water Quality Function	Function	Chemical Regulation	7.58	Higher	Chemical Regulation	6.42	Moderate	Thermal Regulation	5.10	Moderate	Chemical Regulation	8.24	Higher	Chemical Regulation	7.58	Higher	Yes
	Value		2.50	Lower		2.50	Lower		7.40	Higher		2.50	Lower		2.50	Lower	Yes

Notes:

1. Groups are a "roll-up" of individual functions and their associated values organized into thematic categories. For any assessed stream, the specific function selected to represent a function group is that with the highest-rated function and the highest-rated associated value from among the group's members.
2. For Intermittent Stream D, the function rating for Chemical Regulation is Moderate and the value rating is Lower, which matches the predicted condition results for Perennial Stream MS-1.
3. For Perennial Stream MS-1, the function rating for Thermal Regulation is Moderate and the value rating is Higher, which matches the pre-construction results for Intermittent Stream D.

Instructions: For each mitigation method indicate with a "X" in the "Function Match" and the "Value Match" column if the function and value rating post-project for the planned mitigation is equal or greater than the function and value rating pre-project for the impact site, including any overlapping rating break proximity. For each mitigation method indicate with a "X" in the "Exceed" column if the function rating for the planned compensatory mitigation is greater than the function rating for the impact site. "Exceed" means replaced beyond an overlapping rating break proximity. This page does not need to be completed for purchase of Legacy Mitigation Bank Credits.

	Creation			Enhancement			Comparison 3		
	Function Match	Value Match	Exceed	Function Match	Value Match	Exceed	Function Match	Value Match	Exceed
GROUPS									
Hydrologic Function (WS)	X	X							
Water Quality Support (SR, PR, or NR)	X	X							
Fish Habitat (FA or FR)	X	X							
Aquatic Habitat (AM, WBF, or WBN)	X	X							
Ecosystem Support (WC, INV, PD, POL, SBM, or OE)	X	X							
Specific Functions or Values:									
Water Storage & Delay (WS)	X	X							
Sediment Retention & Stabilization (SR)	X	X							
Phosphorus Retention (PR)	X	X							
Nitrate Removal & Retention (NR)	X	X							
Anadromous Fish Habitat (FA)	X	X							
Resident Fish Habitat (FR)	X	X							
Amphibian & Reptile Habitat (AM)	X	X							
Waterbird Nesting Habitat (WBN)	X	X							
Waterbird Feeding Habitat (WBF)	X	X							
Aquatic Invertebrate Habitat (INV)	X	X							
Songbird, Raptor, Mammal Habitat (SBM)	X	X							
Water Cooling (WC)	X	X							
Native Plant Diversity (PD)	X	X							
Pollinator Habitat (POL)	X	X							
Organic Nutrient Export (OE)	X								
Carbon Sequestration (CS)	X								
Public Use & Recognition (PU)		X							

Instructions: For each mitigation method indicate with a "X" in the "Function Match" and the "Value Match" if the function and value rating post-project for the planned mitigation is equal or greater than the function and value rating pre-project for the impact site, including any overlapping rating break proximity. For each mitigation method indicate with a "X" in the "Exceed" column if the function rating for the planned compensatory mitigation is greater than the function rating for the impact site. "Exceed" means replaced beyond an overlapping rating break proximity. This page does not need to be completed for purchase of Legacy Mitigation Bank Credits.

	Creation			Comparison 2			Comparison 3		
	Function Match	Value Match	Exceed	Function Match	Value Match	Exceed	Function Match	Value Match	Exceed
GROUPS									
Hydrologic Function (SWS, SST, FV)	X	X							
Geomorphic Function (SC, SM)	X	X							
Biologic Function (MB, CMH, STS)	X	X							
Water Quality Function (NC, CR, TR)	X	X							
Specific Functions or Values:									
Surface Water Storage (SWS)	X	X							
Sub/Surface Water Transfer (SST)	X	X							
Flow Variation (FV)	X	X							
Sediment Continuity (SC)	X	X							
Sediment Mobility (SM)	X	X							
Maintain Biodiversity (MB)	X	X							
Create and Maintain Habitat (CMH)	X	X							
Sustain Trophic Structure (STS)	X	X							
Nutrient Cycling (NC)	X	X							
Chemical Regulation (CR)	X	X							
Thermal Regulation (TR)	X	X							

Draft Compensatory Mitigation Eligibility and Accounting Determination Form
STEP 1. ELIGIBILITY

INSTRUCTIONS: This eligibility worksheet is used to determine whether a proposed compensatory mitigation site is ecologically appropriate to offset proposed impacts. Final eligibility is determined by the agency. The expectation is that compensatory mitigation sites provide an ecological match (i.e. class, function, and value) to the impact site. In some circumstances, an exception to ecological match may be allowed if the permittee demonstrates that the proposed compensatory mitigation site addresses local or watershed needs or priorities. Enter data in red boxes only. Yellow boxes will populate automatically.

Criteria		RESPONSE	RESULT	COMMENTS
Expectation for providing ecological match for wetlands impacts	Does the mitigation site replace <u>all</u> of the following:			Aquatic Resources of Special Concern must be replaced in-kind and may not otherwise meet all criteria.
	a) HGM class(es) and subclass(es)? ▪ <i>Select yes or no from drop-down list.</i>	Yes	MET	
	b) Cowardin system(s) and class(es)? ▪ <i>Select yes or no from drop-down list.</i>	Yes	MET	
	c) Group-level functions and values? ▪ <i>Compare ORWAP ratings between the impact site and the mitigation site (predicted scores) to determine this. Select yes or no from drop-down list.</i>	Yes	MET	This criterion does not apply when purchasing Legacy Credits, ILF credits not associated with a DSL-approved project, or PIL. Does not apply to non-tidal wetland impacts ≤0.2 acres purchasing credits.
Expectation for providing ecological match for stream impacts	ORKSHEET Does the mitigation site replace <u>all</u> of the following:			Aquatic Resources of Special Concern must be replaced in-kind and may not otherwise meet all criteria.
	a) Flow permanance (intermittent or perennial)? ▪ <i>Select yes or no from drop-down list.</i>	Yes	MET	
	b) Stream size class (small, medium, or large)? ▪ <i>Select yes or no from drop-down list.</i>	Yes	MET	Stream size class as set forth by Oregon Department of Forestry in OAR 629-635-0200 Sections (13) and (14). Mitigation Planning Map Viewer
	c) Essential Indigenous Anadromous Salmonid Habitat (ESH) designation, if the impact is to an ESH stream? ▪ <i>Select yes, no, or Impact site is not ESH from the drop-down list.</i>	Impact Site is not ESH	MET	
	d) Group-level functions and values? ▪ <i>Compare SFAM ratings between the impact site and the mitigation site (predicted scores) to determine this. Select yes or no from drop-down list.</i>	Yes	MET	This criterion does not apply when purchasing Legacy Credits, ILF credits not associated with a DSL approved project, or PIL
If any criterion above are not met, determine whether the mitigation site might qualify for an exception (as a watershed priority) by answering the following two questions. If all criteria above were met, skip the next two questions and move to Step 2: Accounting.				Aquatic Resources of Special Concern are not eligible for an exception and must be replaced in-kind
Possible exception to ecological match	Does the mitigation site:			
	a) Address a watershed priority, as identified in a planning or assessment document, report, or other data? ▪ <i>Must be fully described in the permit application. Select yes or no from the drop-down list.</i>			
	b) Provide a high level of the functions and values that are relevant to the targeted priority (either currently or post-construction)? ▪ <i>Must be fully described in the permit application. Select yes or no from the drop-down list.</i>			

STEP 2. ACCOUNTING

INSTRUCTIONS: This accounting worksheet is used to estimate a permittee's wetland mitigation requirements, specific to a particular impact and proposed mitigation site. There are no minimum requirements defined for streams. Final requirements will be determined by the agency. Requirements are based on (1) the mitigation method, (2) the function/value replacement achieved, (3) function temporal loss factors, (4) level of function replacement, and (5) stewardship and site protection plans. Enter data in red boxes only. Yellow boxes will populate automatically. A separate column must be used for each mitigation method used (e.g. if a mitigation site includes both restoration and enhancement, the mitigation method for those distinct areas must be calculated in separate columns). A separate column may also be used to allow different function temporal loss factors to be applied to different acreages, even if the mitigation method being used on that acreage is the same.

Factor	Method 1	Method 2	Method 3	Notes
Mitigation method What method(s) of mitigation is proposed? • Select an option from drop-down list.	Creation			If purchasing credits, ILF or PIL, select "credit purchase." Minimum requirements for preservation and non-wetland waters are case-by-case, as determined by the Department.
MINIMUM MITIGATION REQUIREMENT (acres of mitigation required per acre of impact)	1.00	0.00		

Note: Adjustments do not apply to non-tidal wetland impacts ≤0.2 acres purchasing credits as mitigation; select "Not applicable" for each factor.

Specific function and value replacement (increase factor)	How many specific functions and values from the impact site are replaced at the mitigation site? • Compare ORWAP ratings between the impact site and the mitigation site (predicted scores) to determine this. Select an option from drop-down list.	≥13 matches + 0%			Select "Not applicable" if the mitigation site is approved/seeking approval as an exception to in-kind replacement under a watershed priority approach, if purchasing legacy credits, or best professional judgement was used to assess functions and values.
Function temporal loss (increase factor)	Which factor, if any, will cause the greatest temporal loss of function? • Select first applicable option from drop-down list.	Deciduous forest impacted + 50%			Soil adjustment factors are not applicable to credit purchases or removal of historic fill. Vegetation and soil adjustments may not apply when the mitigation method is preservation.
High level of function replacement (decrease factor)	Does the CM site exceed at least 80% of the specific functions being lost at the impact site? • Compare ORWAP function ratings between the impact site and the mitigation site (predicted scores) to determine this. Select an option from drop-down list.	Not applicable - 0%			"Exceed" means replaced beyond an overlapping rating break proximity. Select "Not applicable" if the mitigation site is approved/seeking approval as an exception to in-kind replacement under a watershed priority approach, if purchasing legacy credits, or best professional judgement was used to assess functions and values.
Mitigation site protection & stewardship (decrease factor)	What level of site protection and stewardship is proposed for the mitigation site? • Select an option from the drop-down list.	Minimum requirements - 0%			Mitigation banks and ILFs typically have enhanced stewardship. Minimum mitigation requirement is 1 acre credit to 1 acre of impact.
Total adjustment (percent increase)		50%			
ADJUSTED MITIGATION REQUIREMENT (acres of mitigation required per acre of impact)		1.50			

	Method 1	Method 2	Method 3	Notes
Acreage of impact* (*enter the acreage associated with each method)	11.56			Insert the area of unavoidable permanent impact
MITIGATION ACREAGE REQUIRED (adjusted mitigation requirement * impacted acreage)	17.34			
TOTAL MITIGATION REQUIRED WITHOUT BUFFERS	17.34	This is the mitigation acreage required if a buffer is not required by DSL		

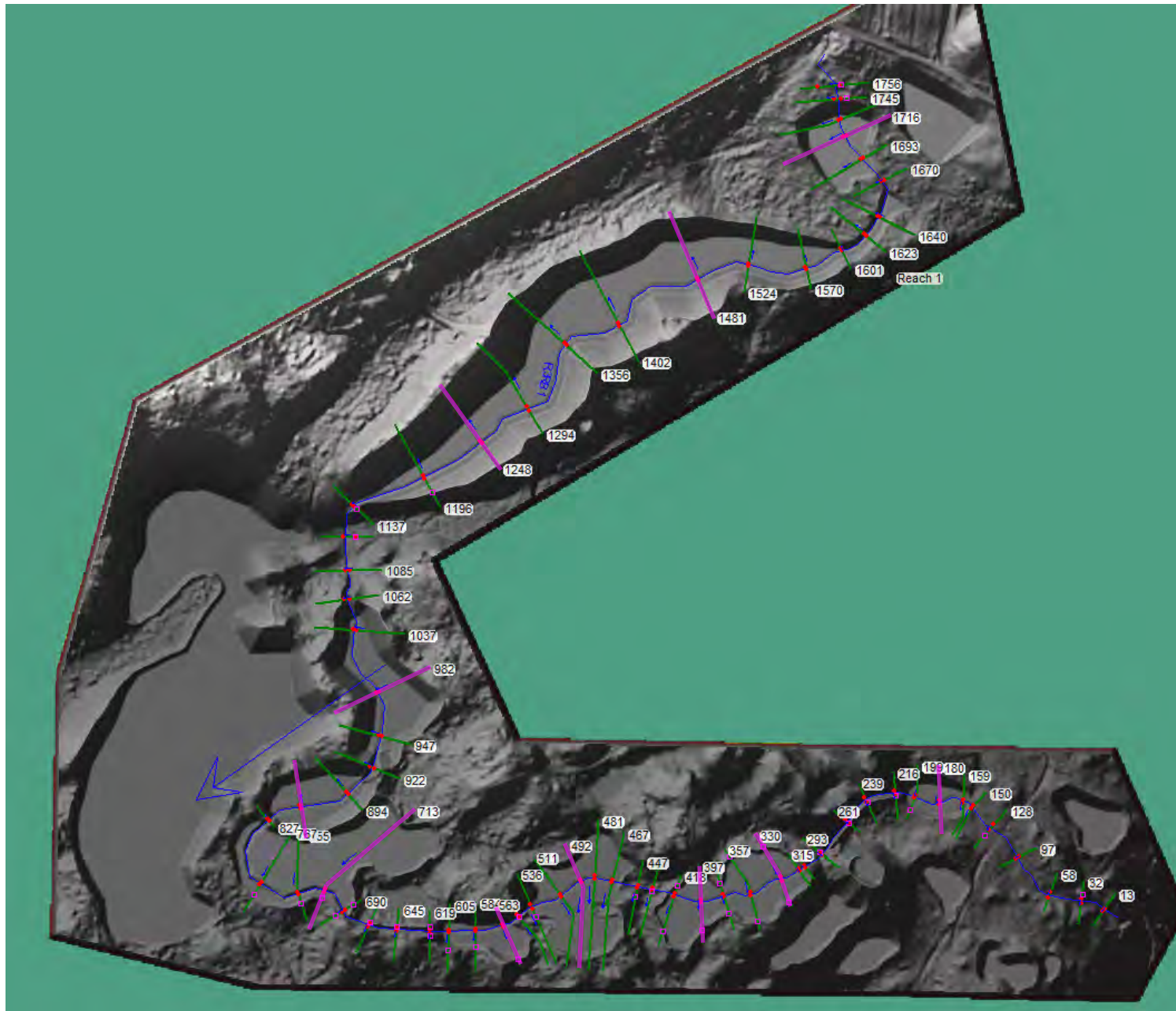
COMPENSATORY MITIGATION - ROUTINE ELIGIBILITY ACCOUNTING

This section is only used if DSL requires a buffer at the compensatory mitigation project					
Factor	Method 1	Method 2	Method 3	Notes	
Credit for DSL Required Buffers	Buffer acreage				Use multiple methods only if more than one ratio will be applied to the buffer.
	Buffer credit ratio				DSL will determine the credit ratio for required buffers. Enter the acres of buffer required per credit (e.g. for 10:1, enter 10).
	Buffer Credit				
	Total Buffer Credit	0			
TOTAL MITIGATION REQUIRED WITH BUFFER CREDITS APPLIED			This is the mitigation acreage required if buffers are required by DSL		

WORKSHEET

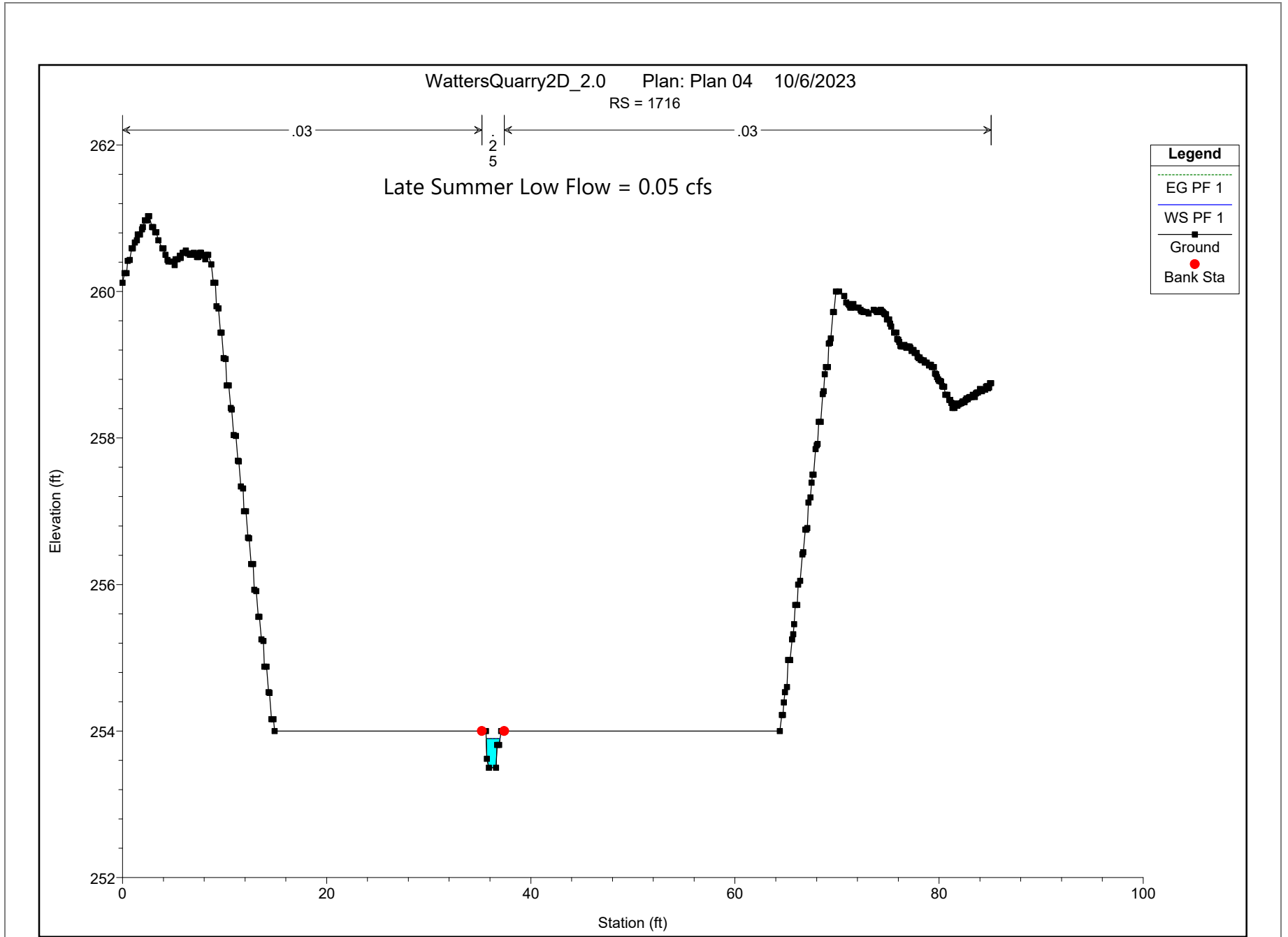
Appendix D

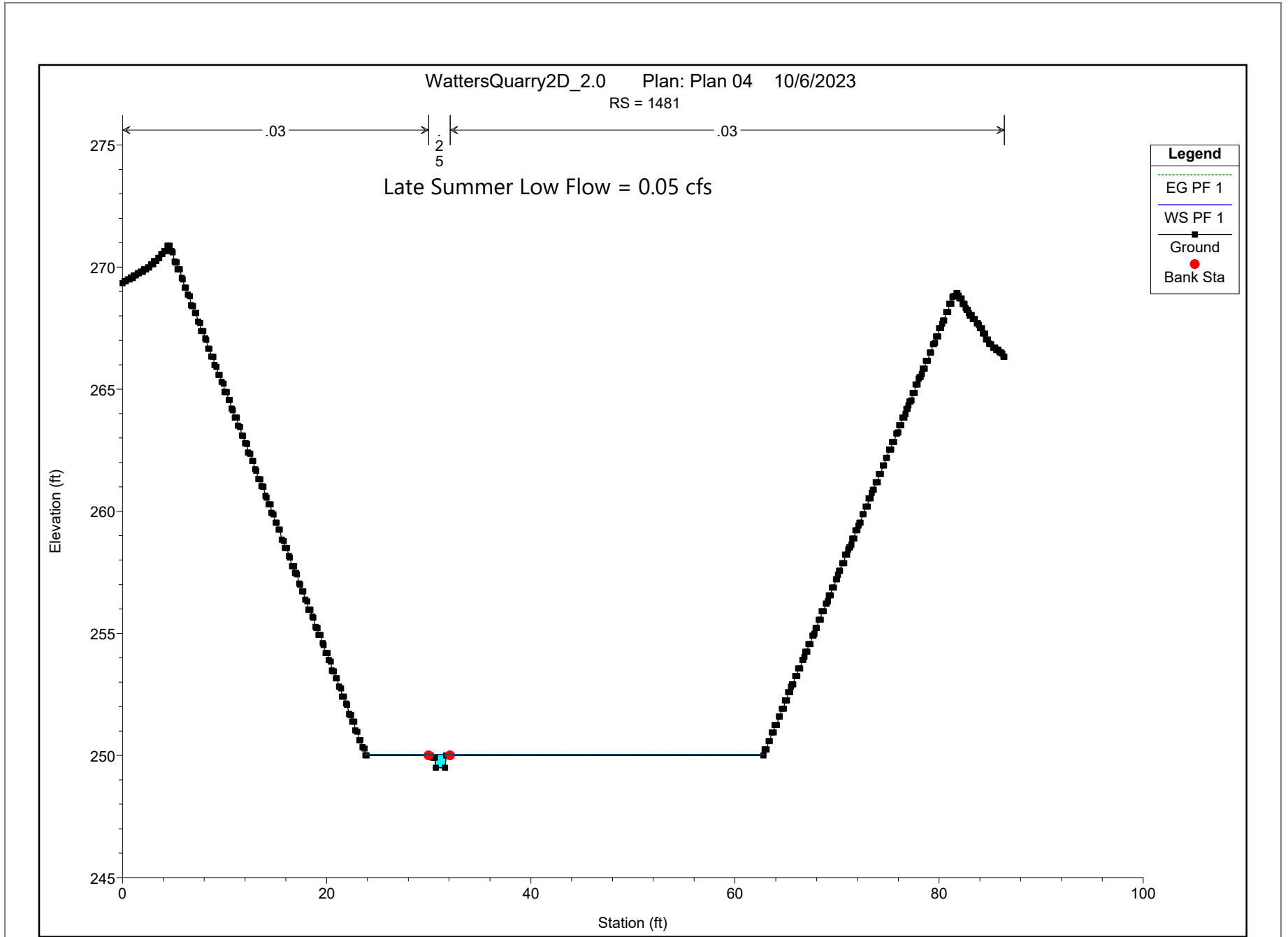
HEC-RAS Modeling Results

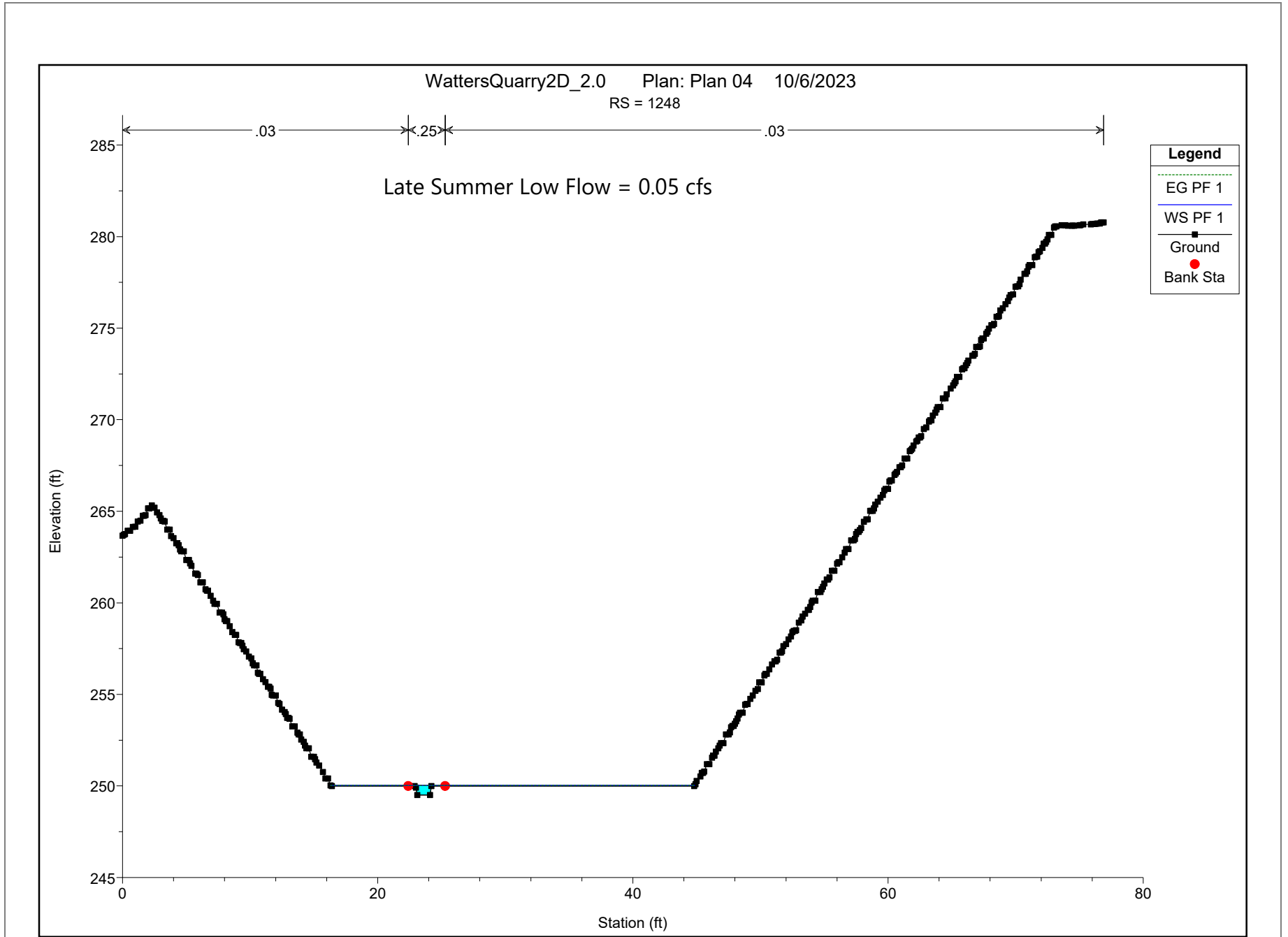


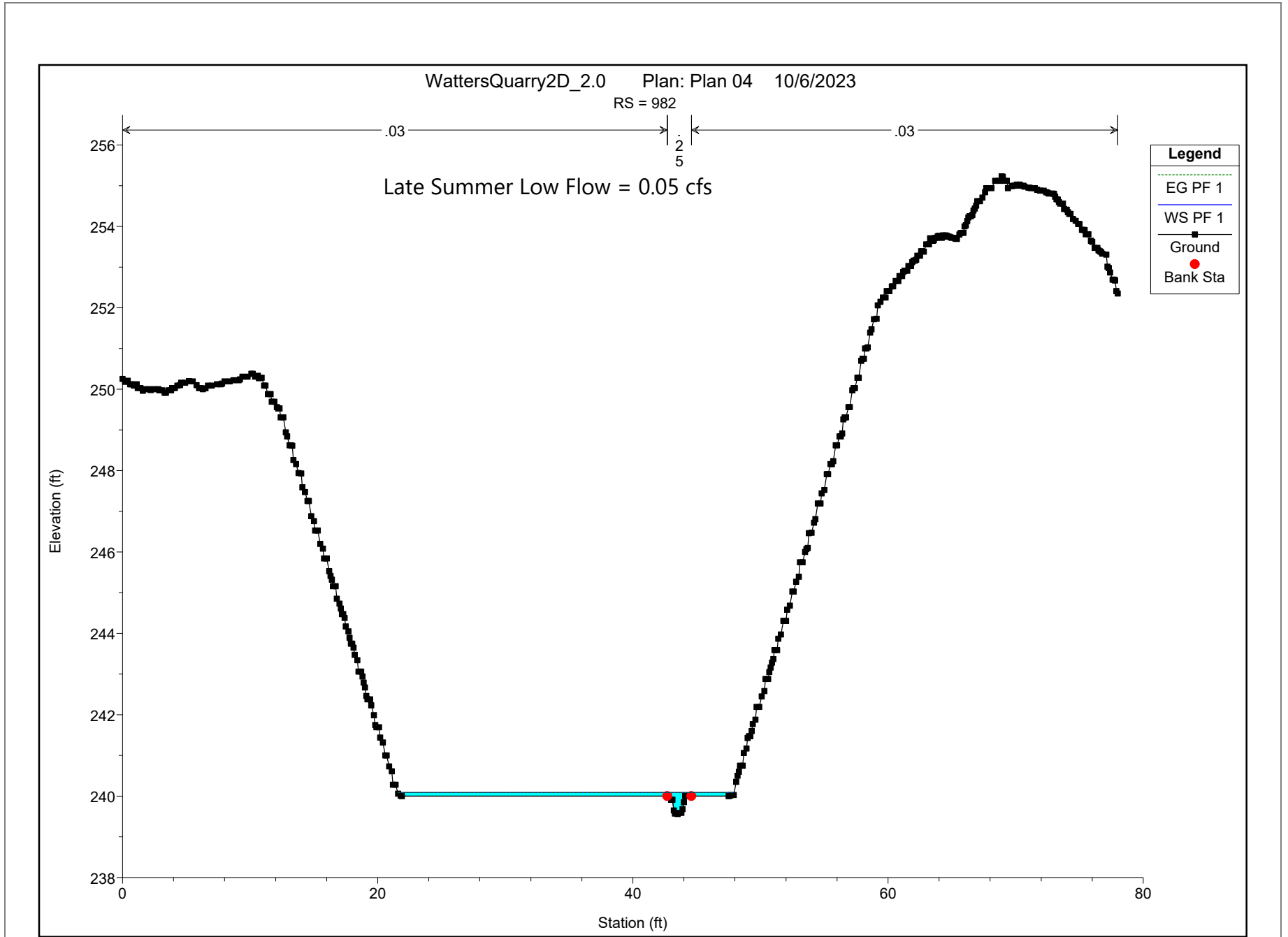
LEGEND:

- Cross-Section
- 1716 River Station
- Selected Cross-Section in Figures





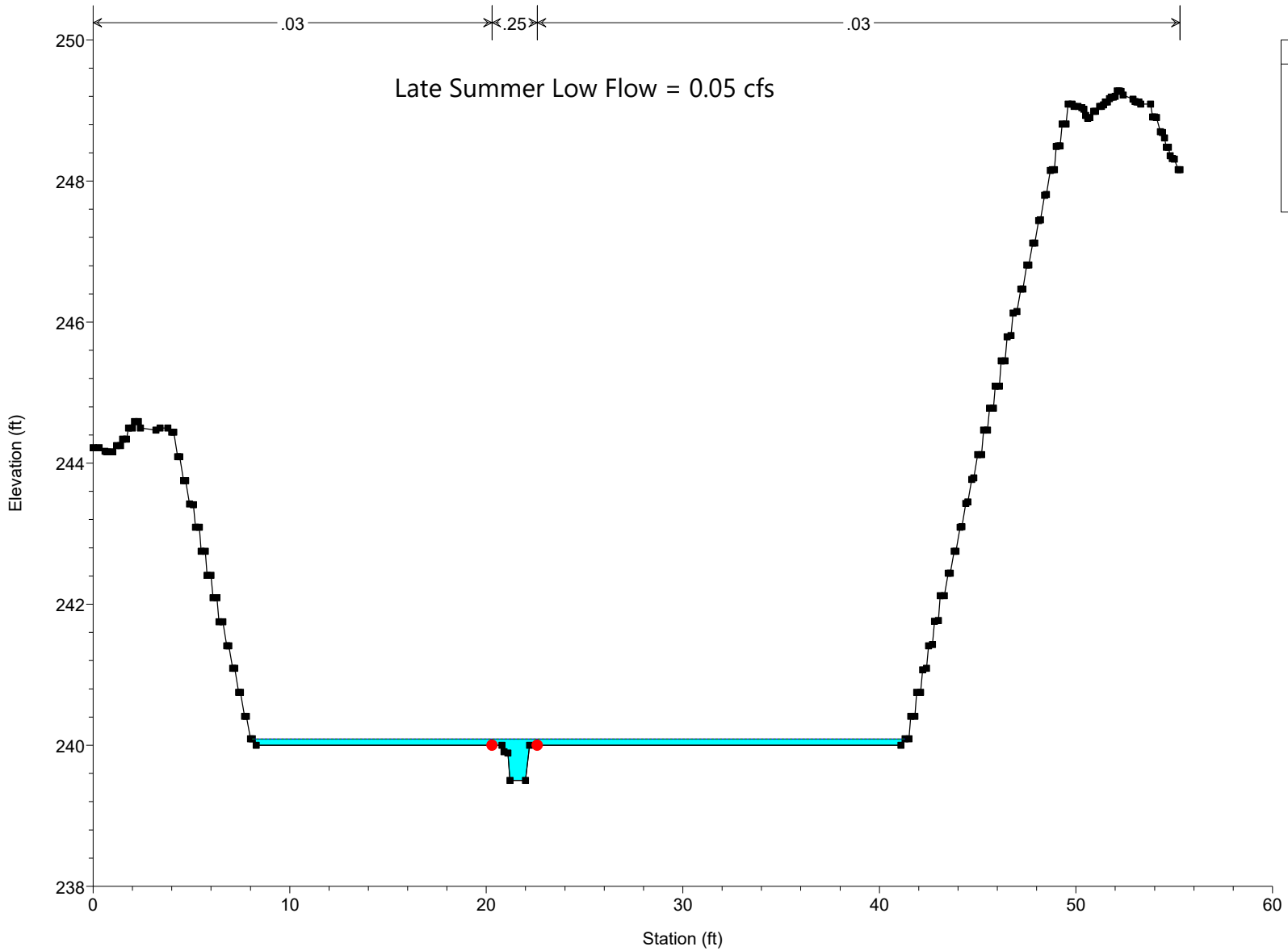




WattersQuarry2D_2.0 Plan: Plan 04 10/6/2023
RS = 855

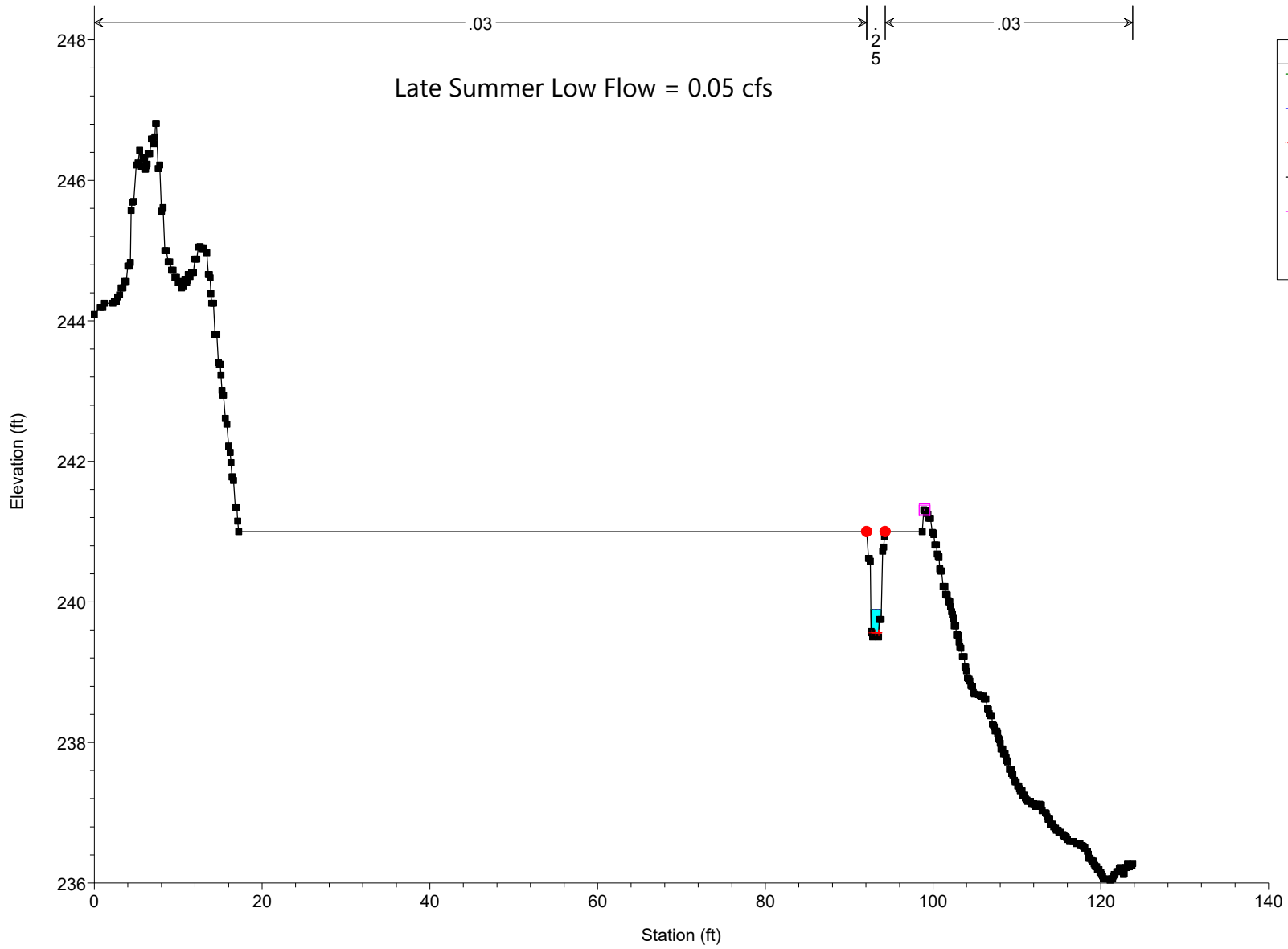
Late Summer Low Flow = 0.05 cfs

Legend	
WS PF 1	—
EG PF 1	- - -
Ground	■
Bank Sta	●



WattersQuarry2D_2.0 Plan: Plan 04 10/6/2023
RS = 713

Late Summer Low Flow = 0.05 cfs



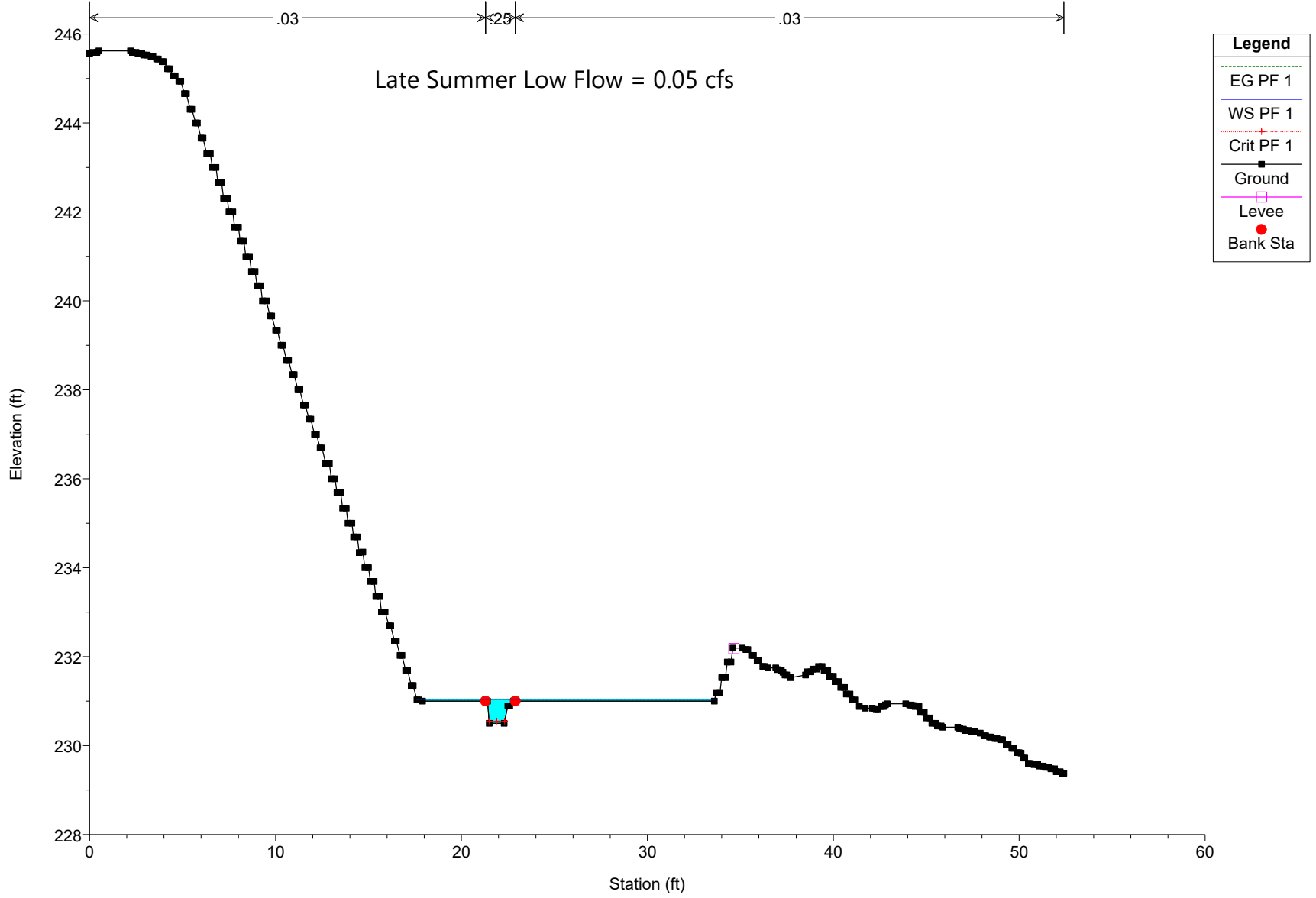
Legend	
EG PF 1	—
WS PF 1	—
Crit PF 1	+
Ground	■
Levee	□
Bank Sta	●

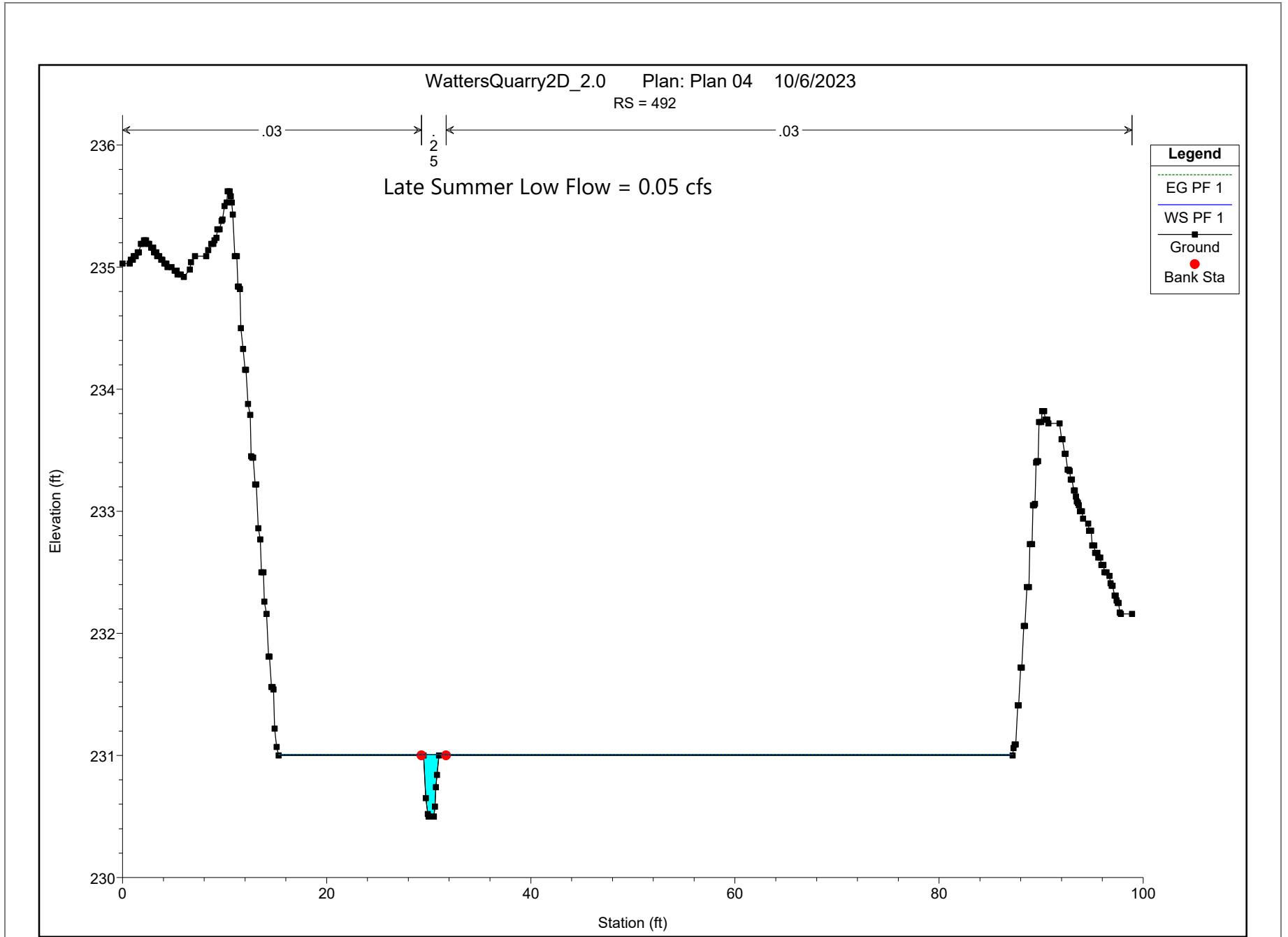


Figure D-2F
HEC-RAS Hydraulic Model Results

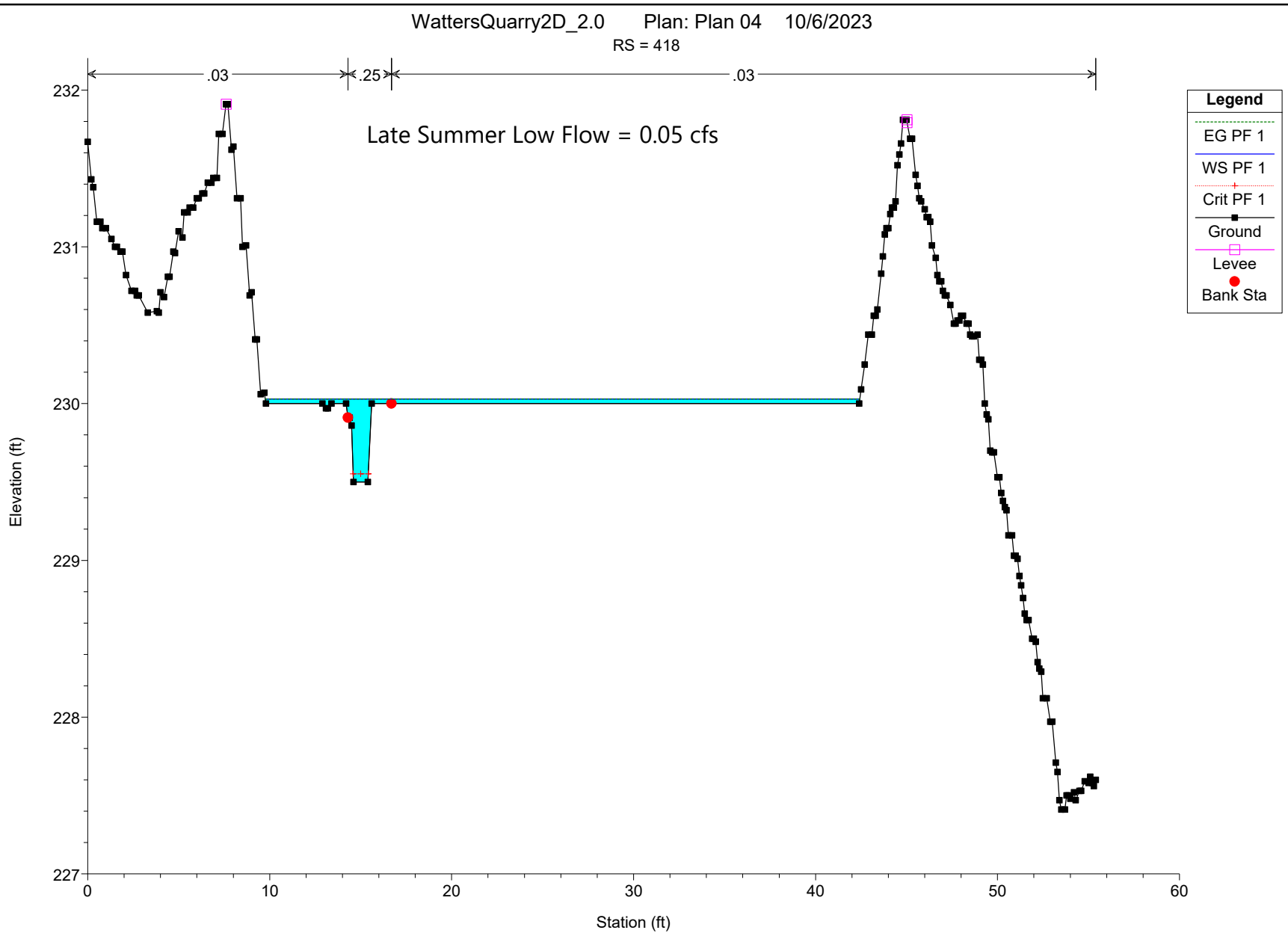
Compensatory Mitigation Plan Appendix D
Watters Quarry Phase II

WattersQuarry2D_2.0 Plan: Plan 04 10/6/2023
RS = 584





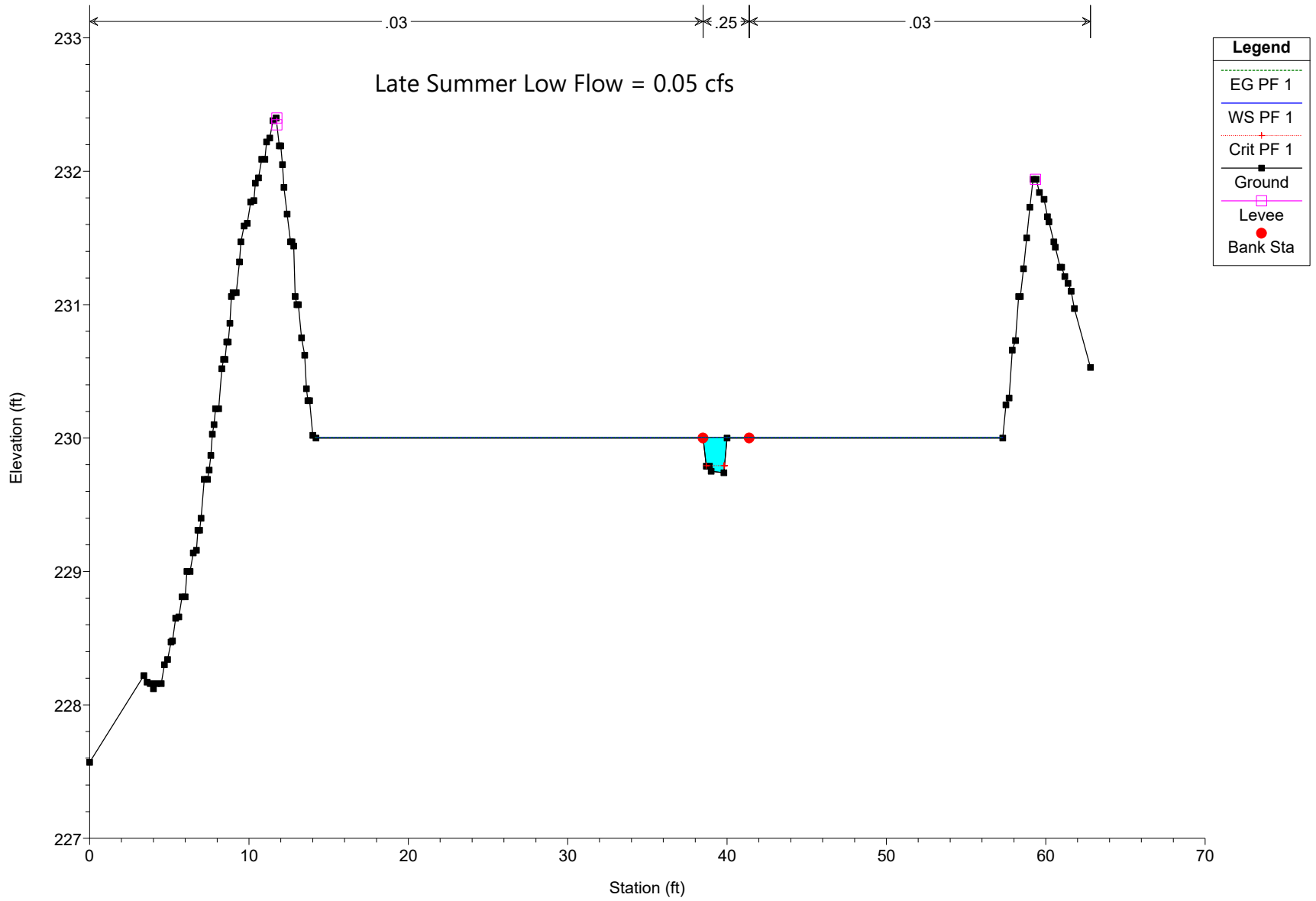
WattersQuarry2D_2.0 Plan: Plan 04 10/6/2023
RS = 418



WattersQuarry2D_2.0 Plan: Plan 04 10/6/2023

RS = 330

Late Summer Low Flow = 0.05 cfs



Legend	
EG PF 1	---
WS PF 1	—
Crit PF 1	- - - +
Ground	—■—
Levee	—□—
Bank Sta	●



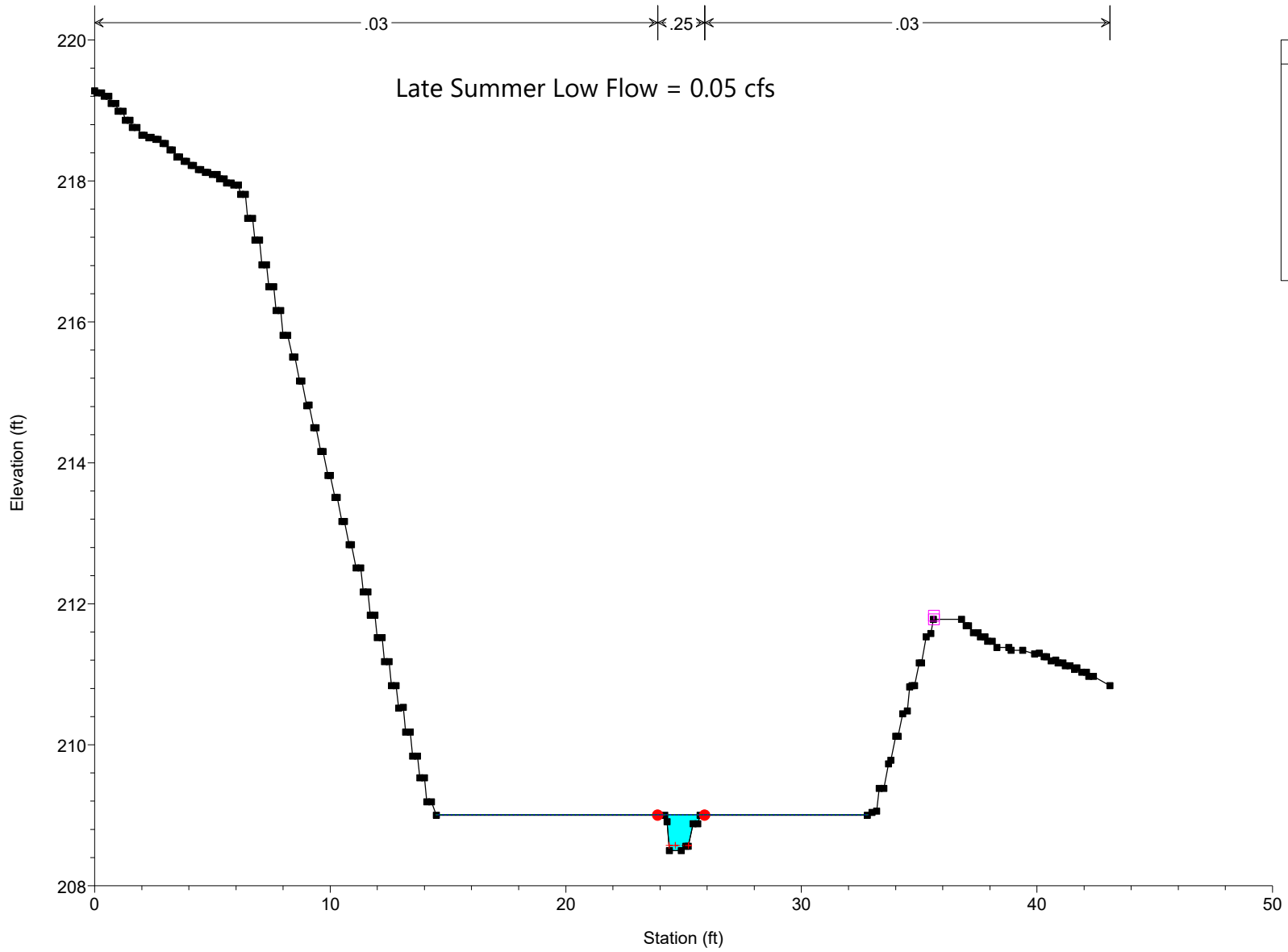
Figure D-2J
HEC-RAS Hydraulic Model Results

Compensatory Mitigation Plan Appendix D
Watters Quarry Phase II

WattersQuarry2D_2.0 Plan: Plan 04 10/6/2023

RS = 199

Late Summer Low Flow = 0.05 cfs

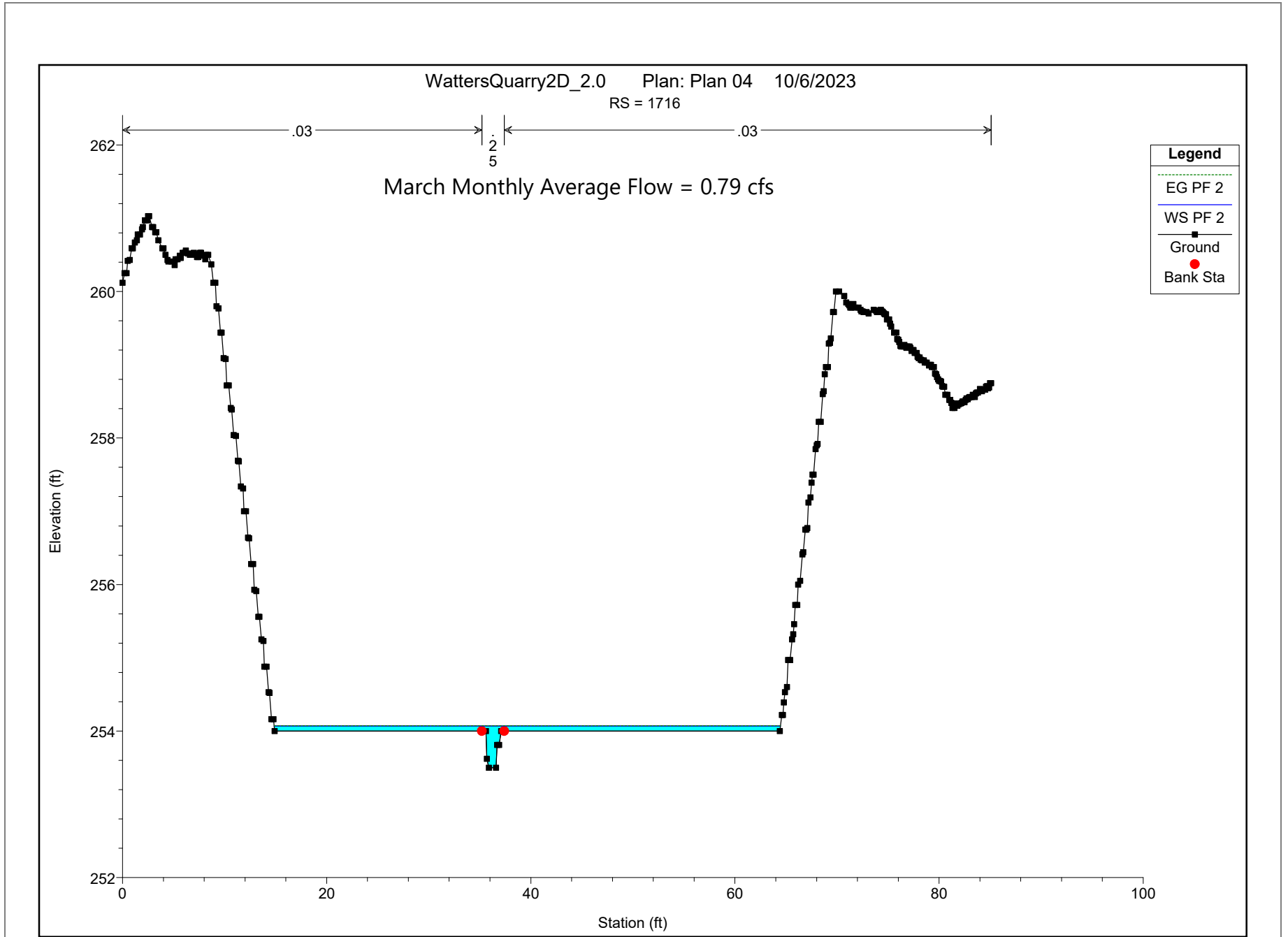


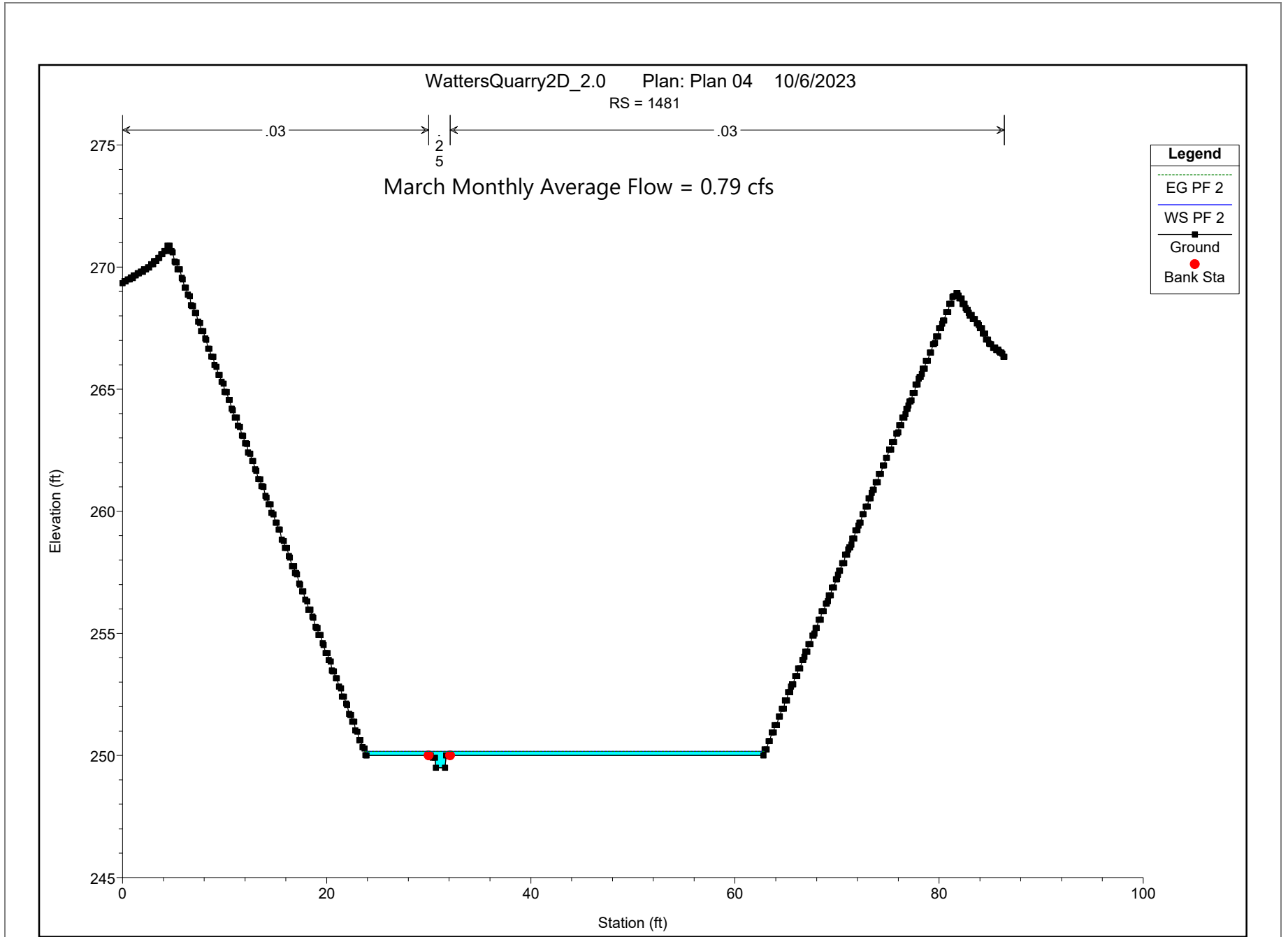
Legend	
EG PF 1	(dashed green line)
WS PF 1	(blue line)
Crit PF 1	(red line with plus)
Ground	(black line with square)
Levee	(pink line with square)
Bank Sta	(red dot)

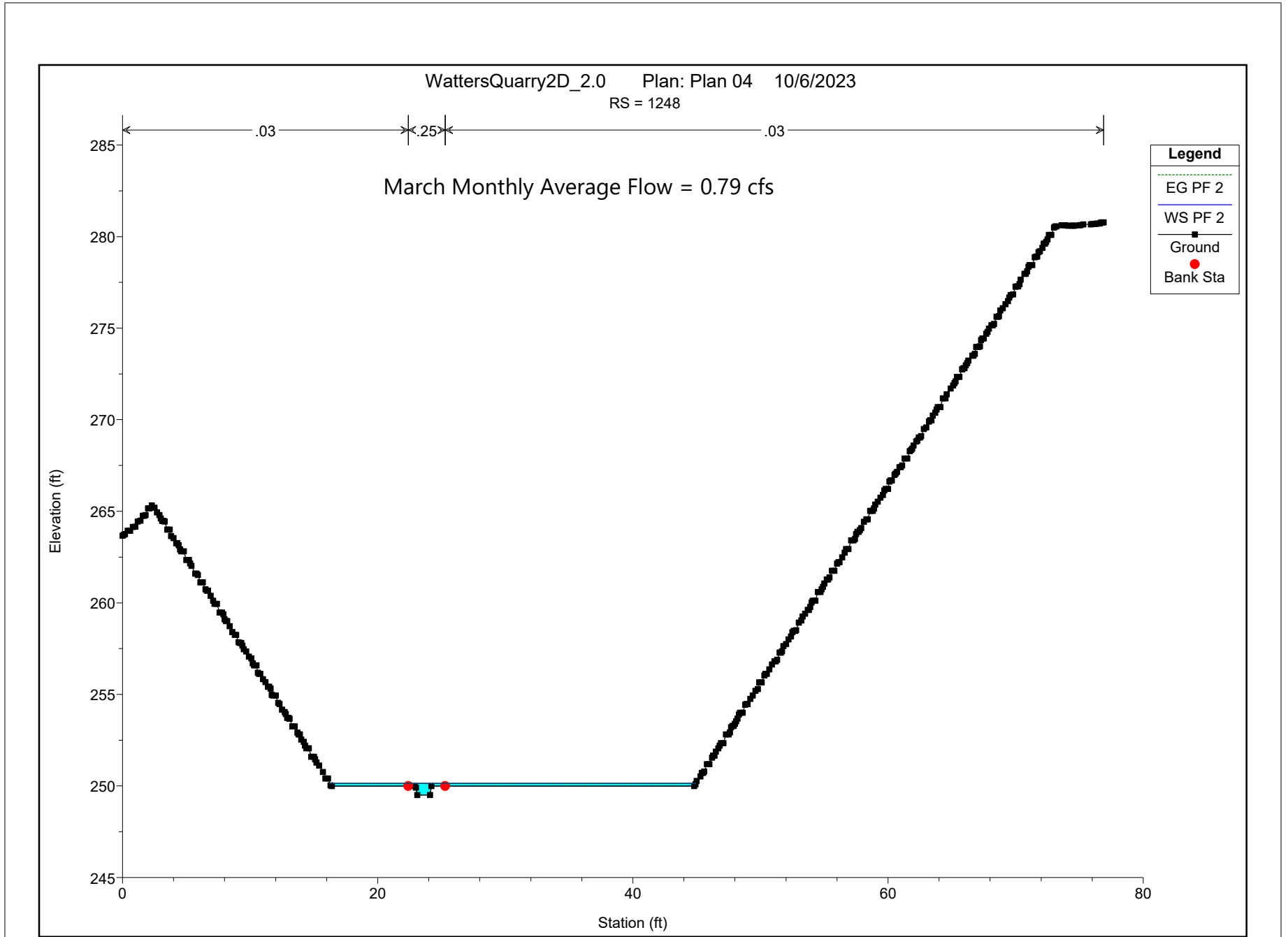


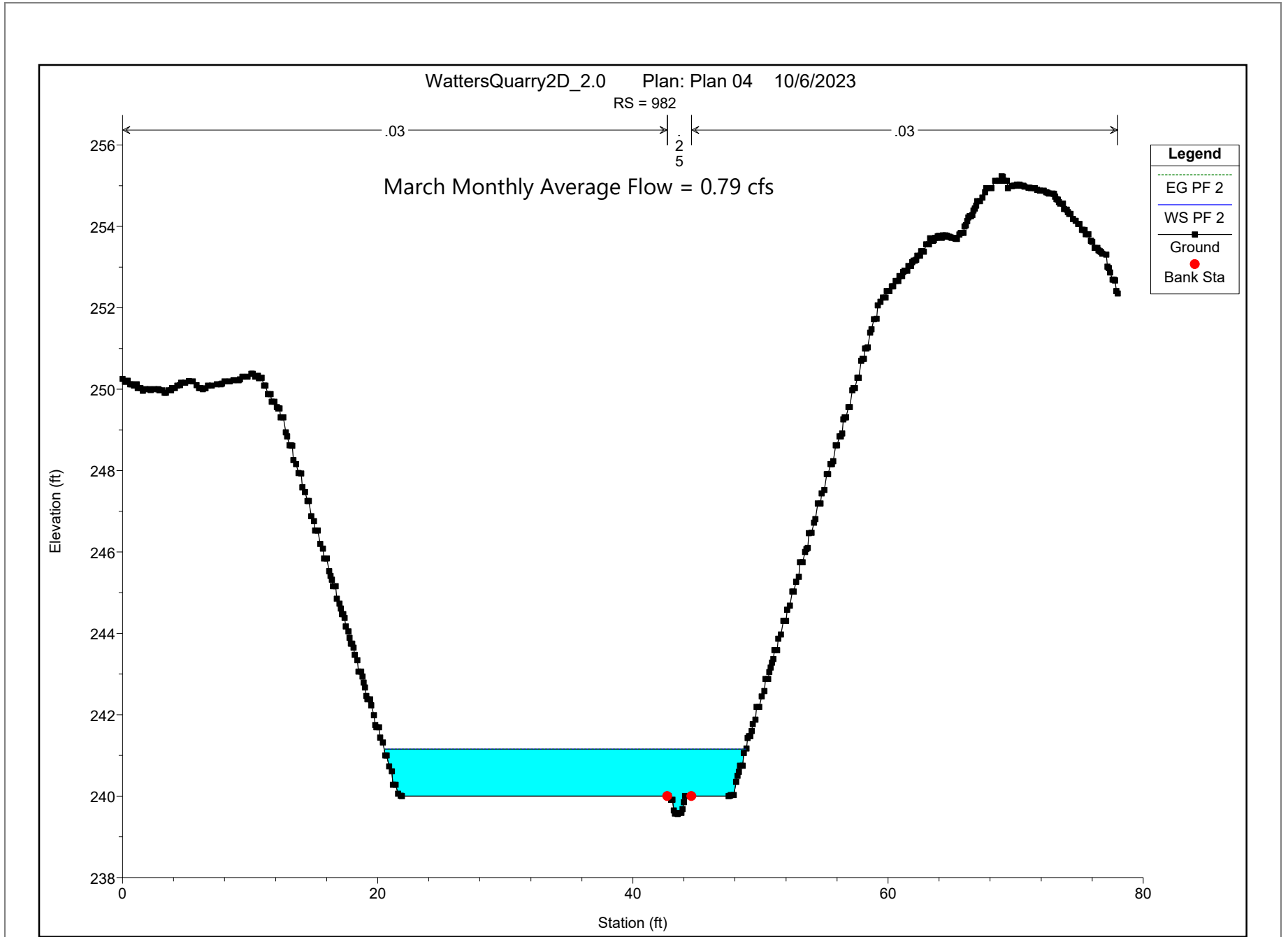
Figure D-2K
HEC-RAS Hydraulic Model Results

Compensatory Mitigation Plan Appendix D
Watters Quarry Phase II



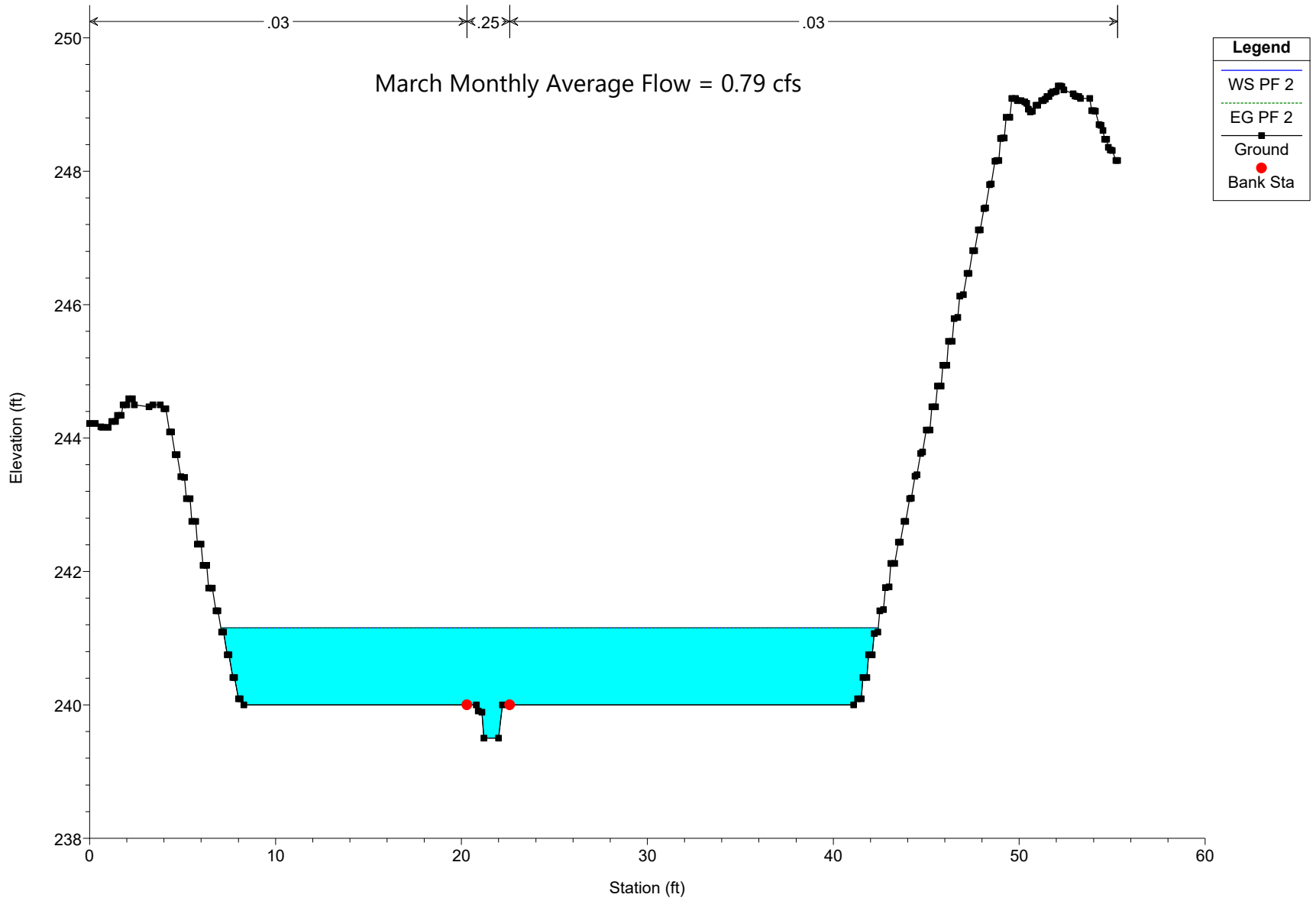






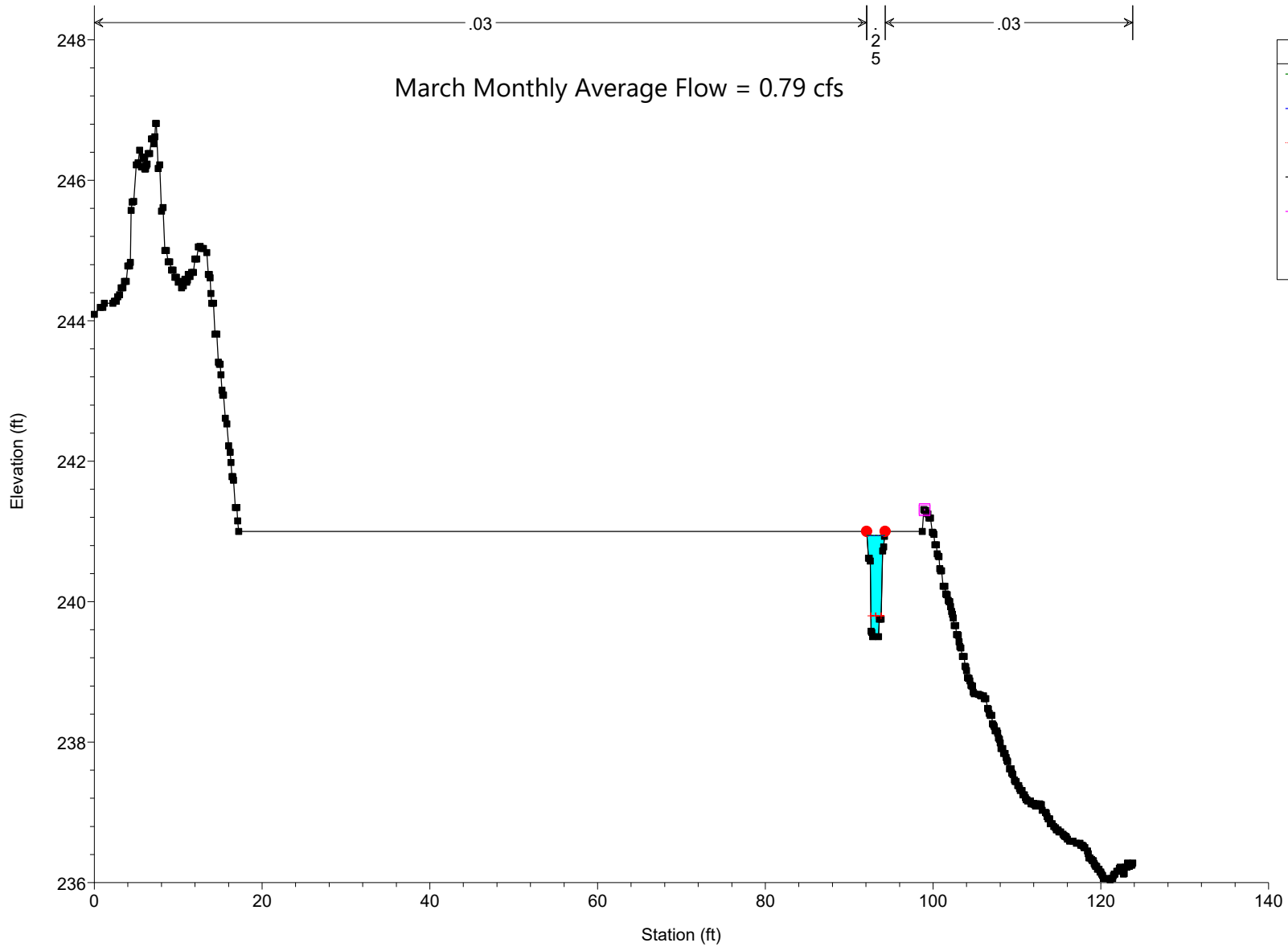
WattersQuarry2D_2.0 Plan: Plan 04 10/6/2023
RS = 855

March Monthly Average Flow = 0.79 cfs

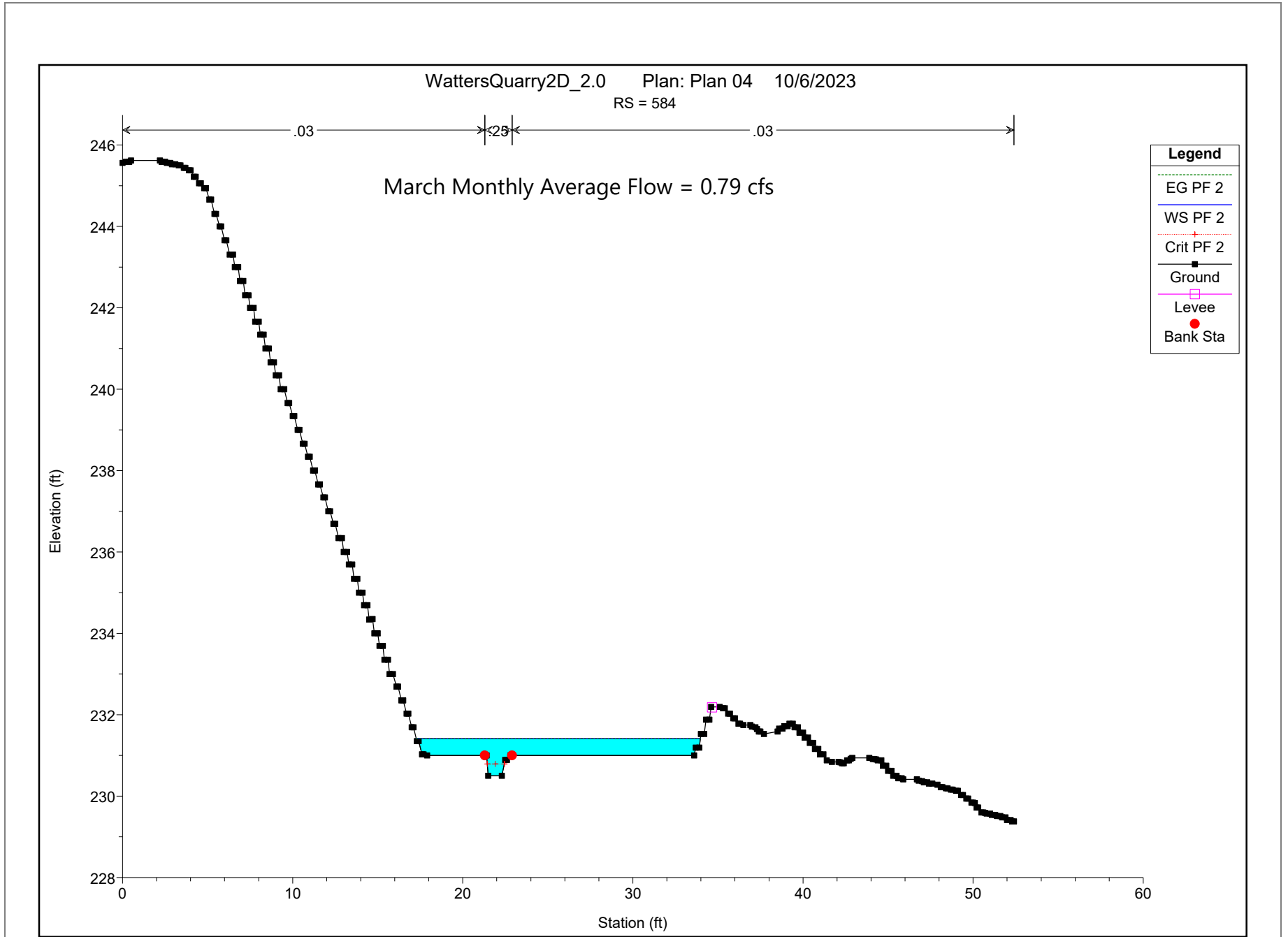


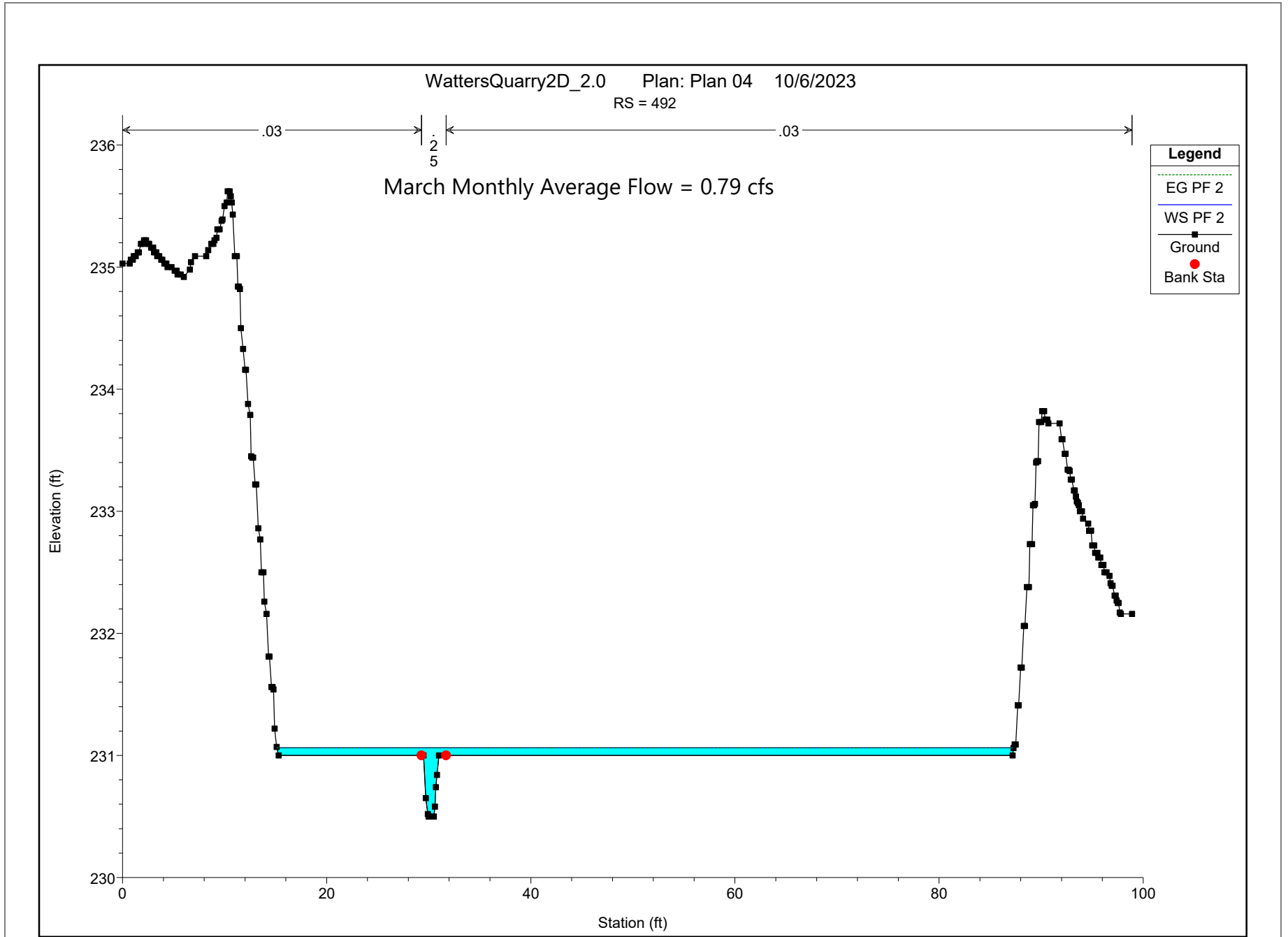
WattersQuarry2D_2.0 Plan: Plan 04 10/6/2023
RS = 713

March Monthly Average Flow = 0.79 cfs

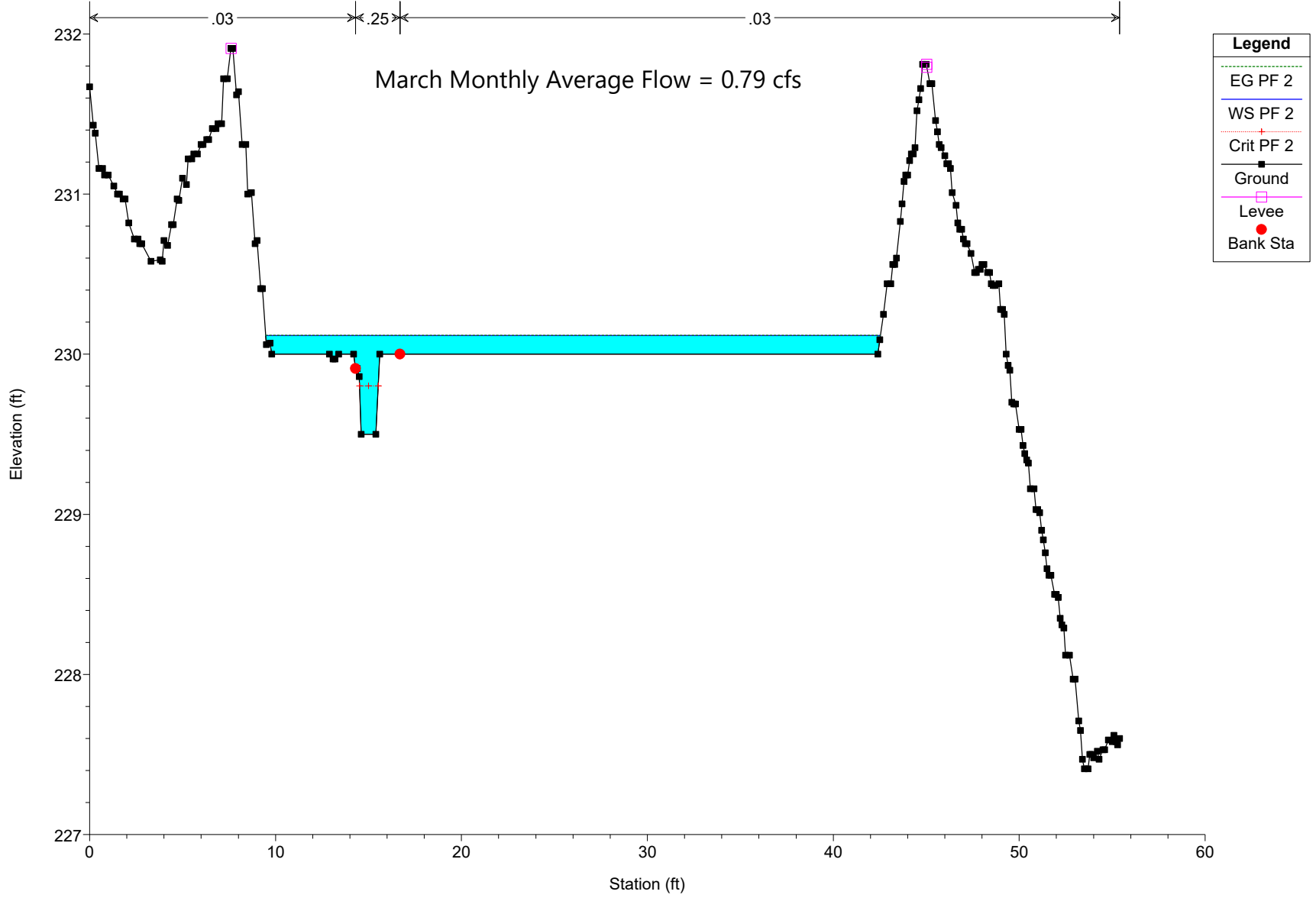


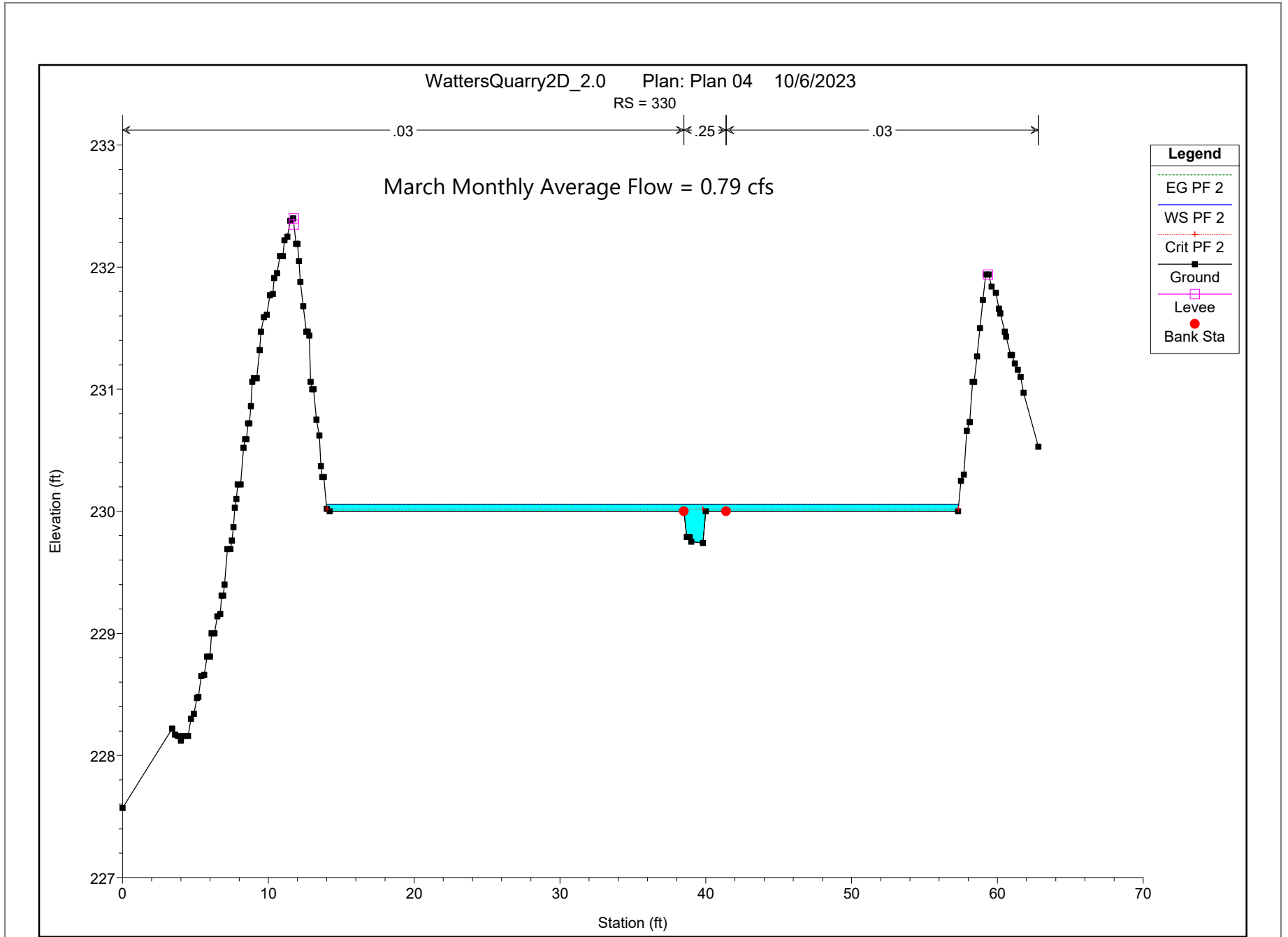
Legend	
EG PF 2	(dotted green line)
WS PF 2	(blue line)
Crit PF 2	(red line)
Ground	(black line with square markers)
Levee	(cyan bar)
Bank Sta	(red dot)

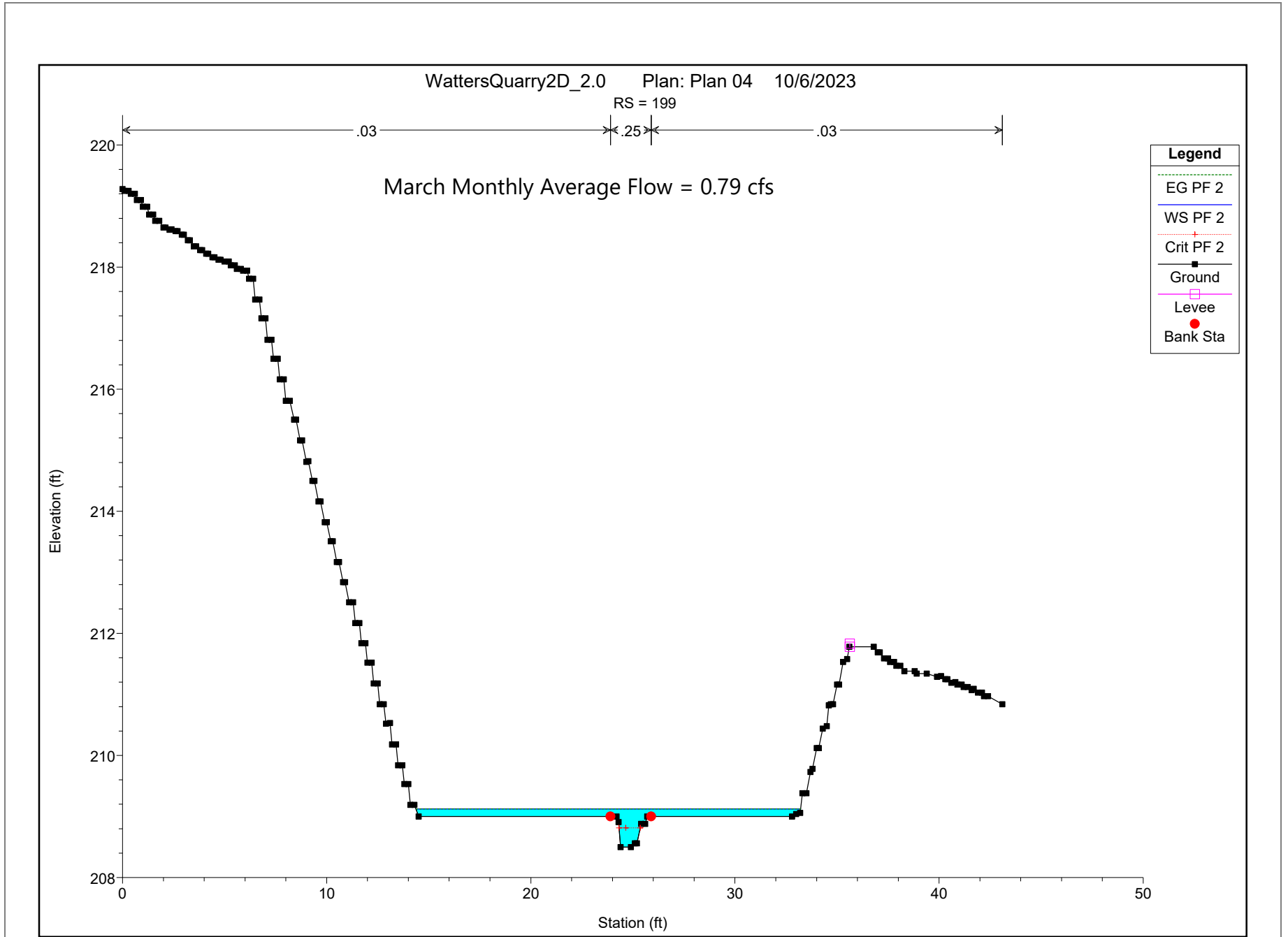


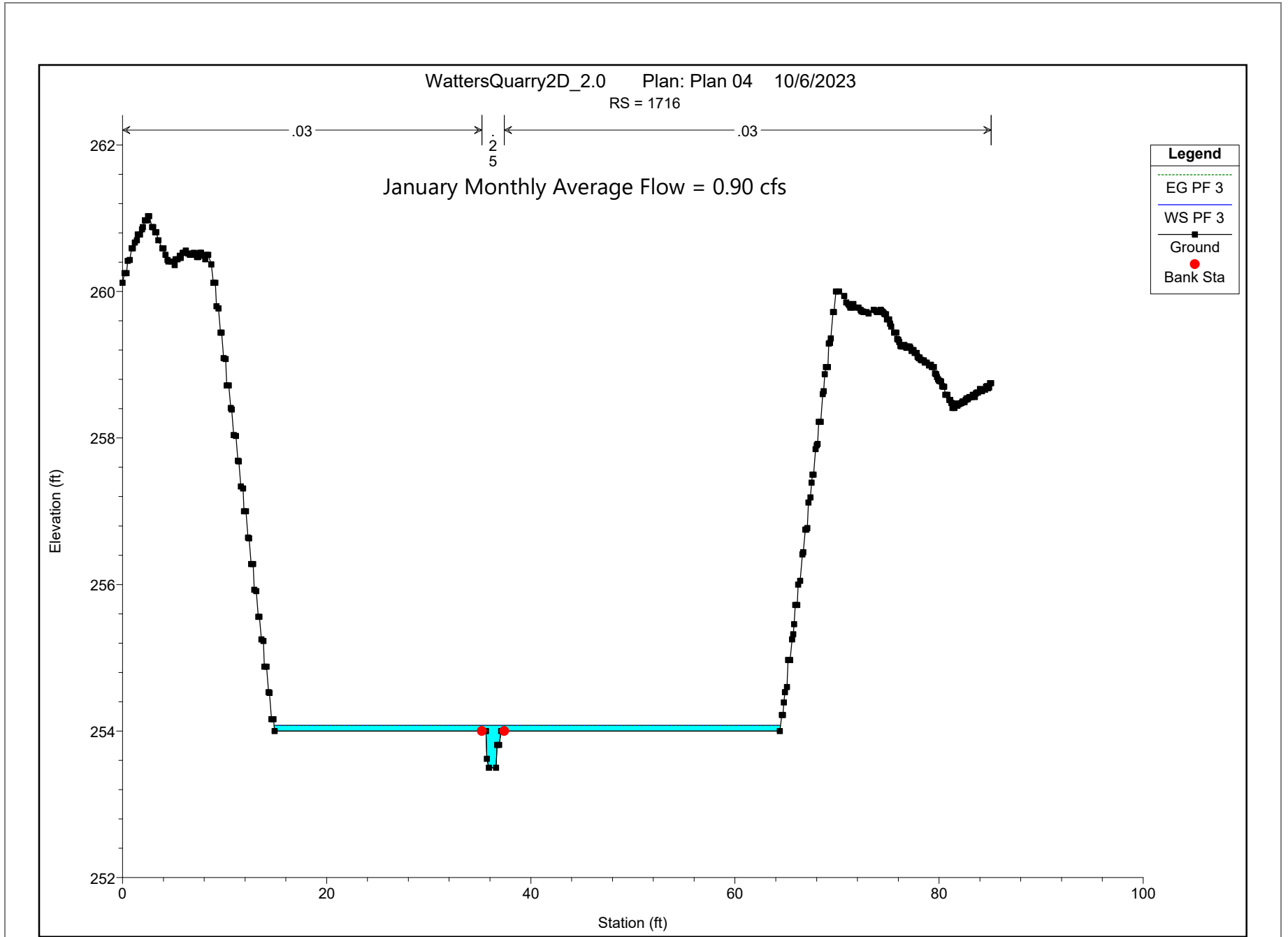


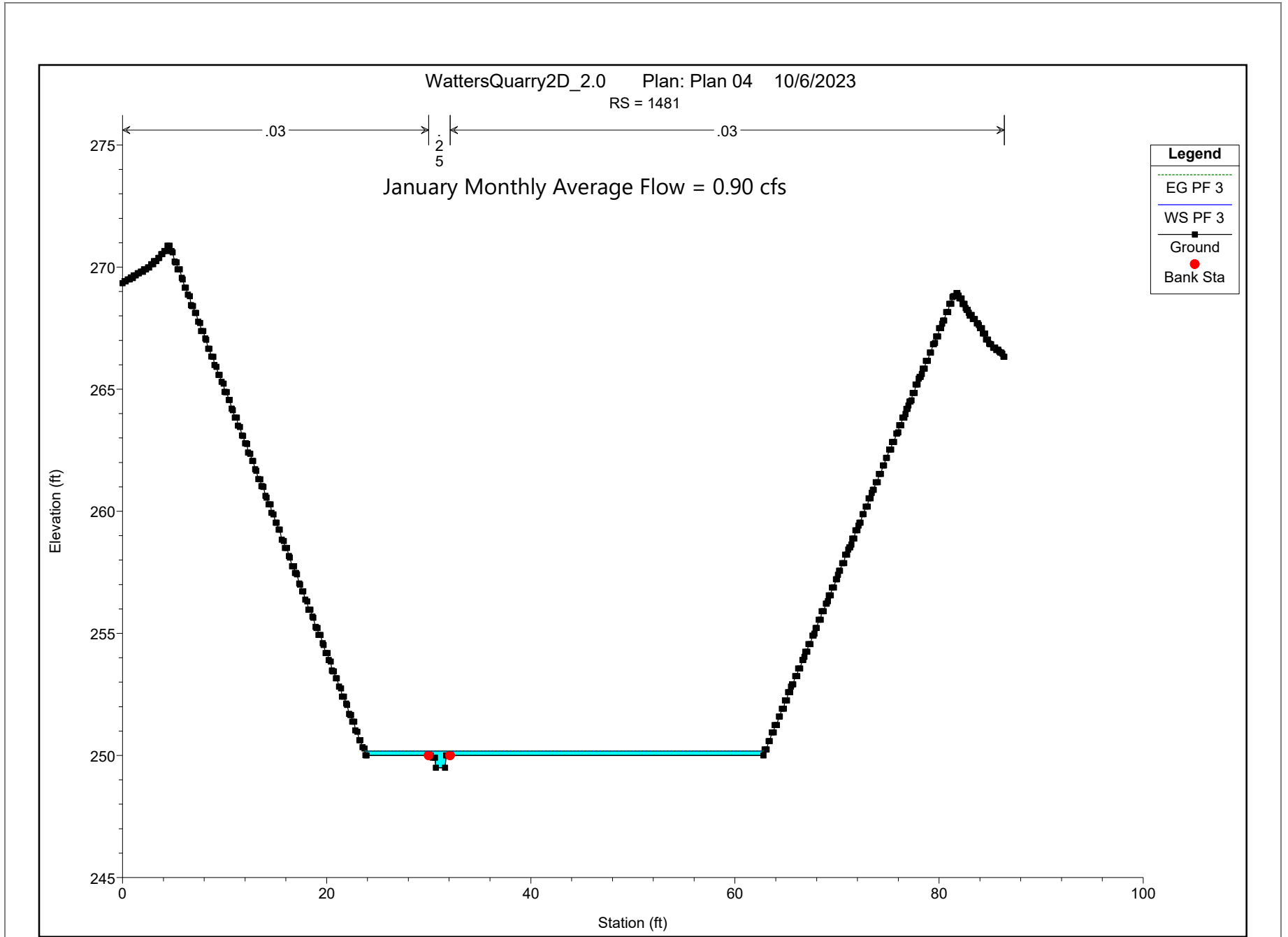
WattersQuarry2D_2.0 Plan: Plan 04 10/6/2023
RS = 418

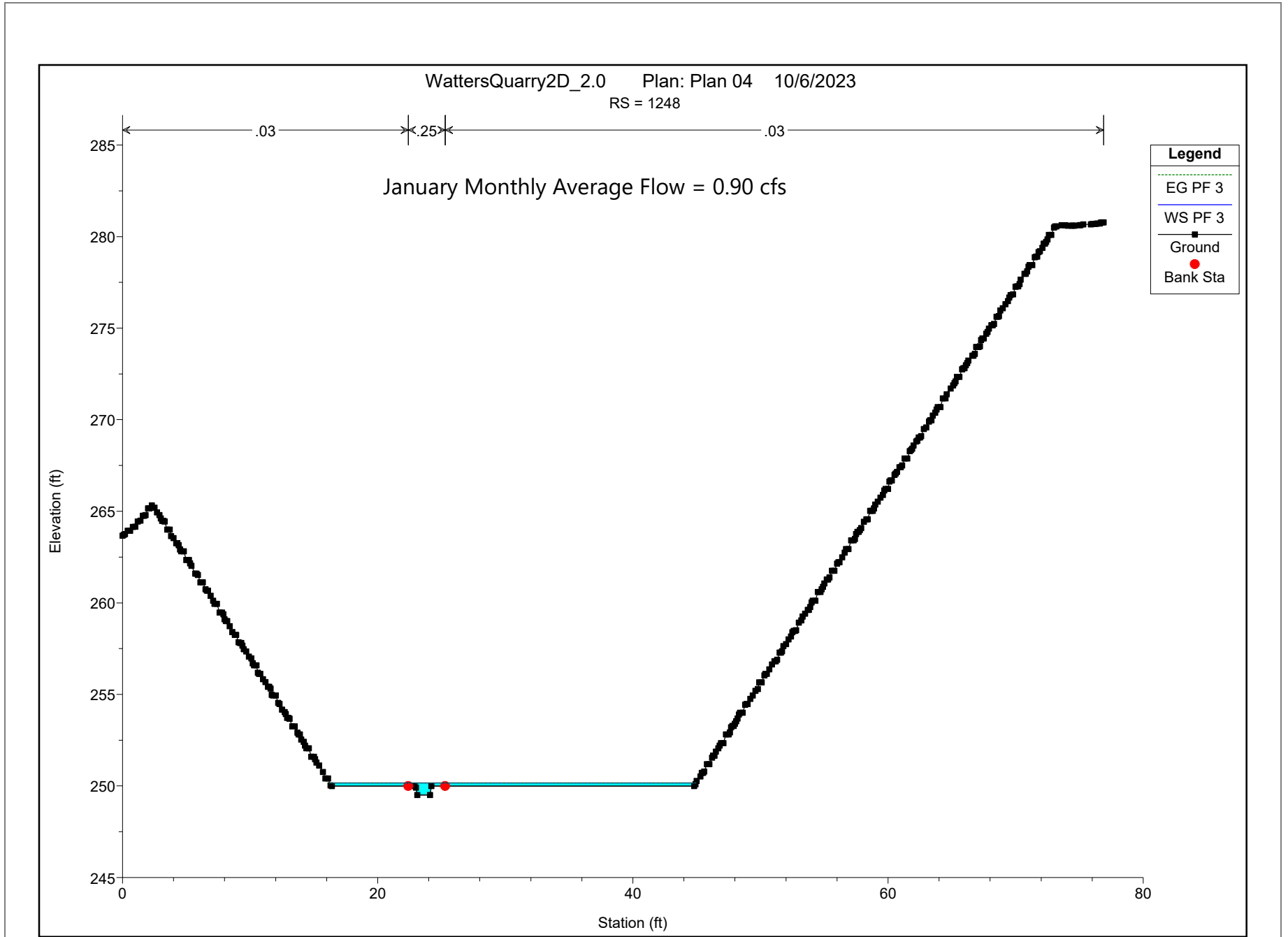


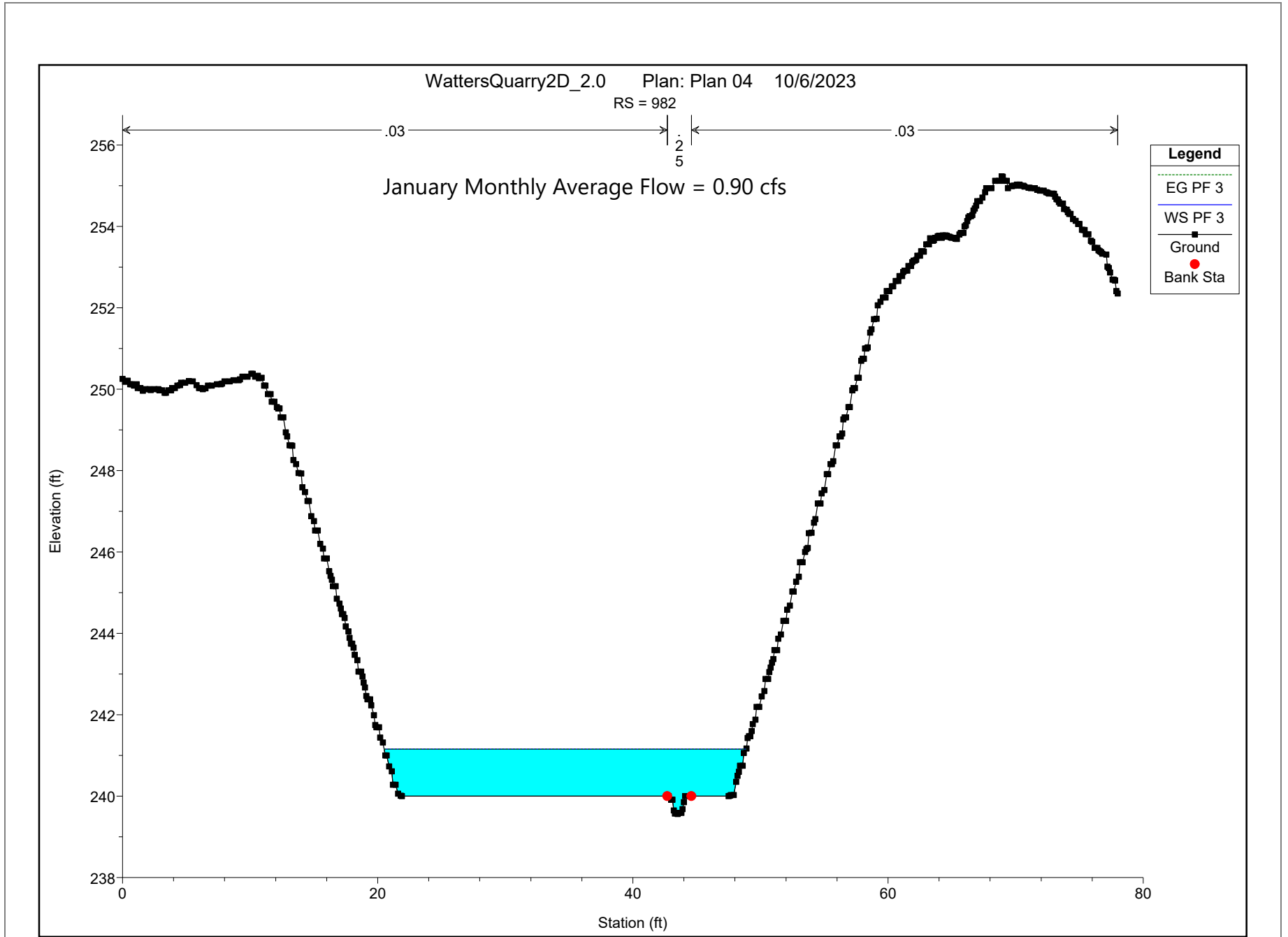






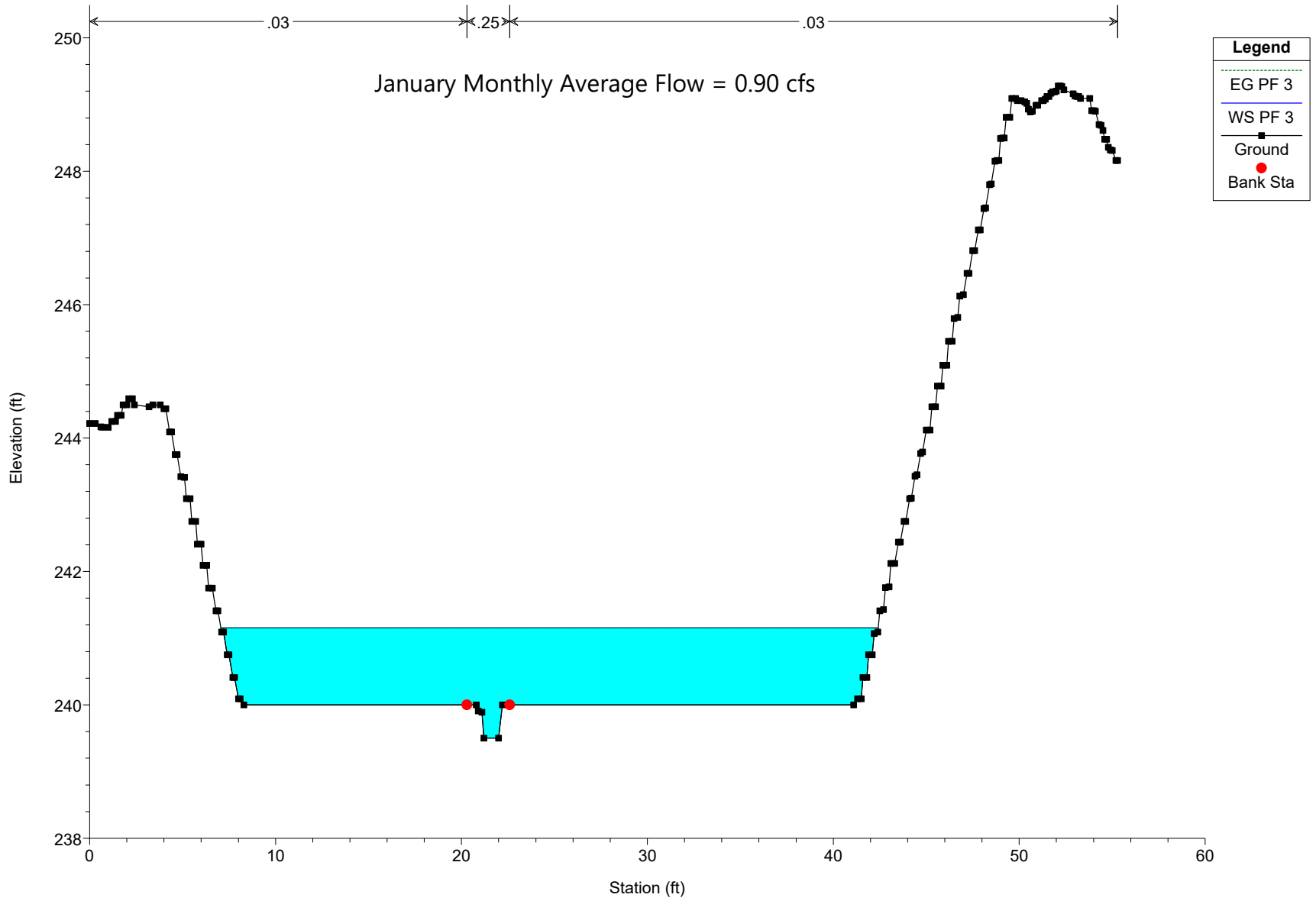






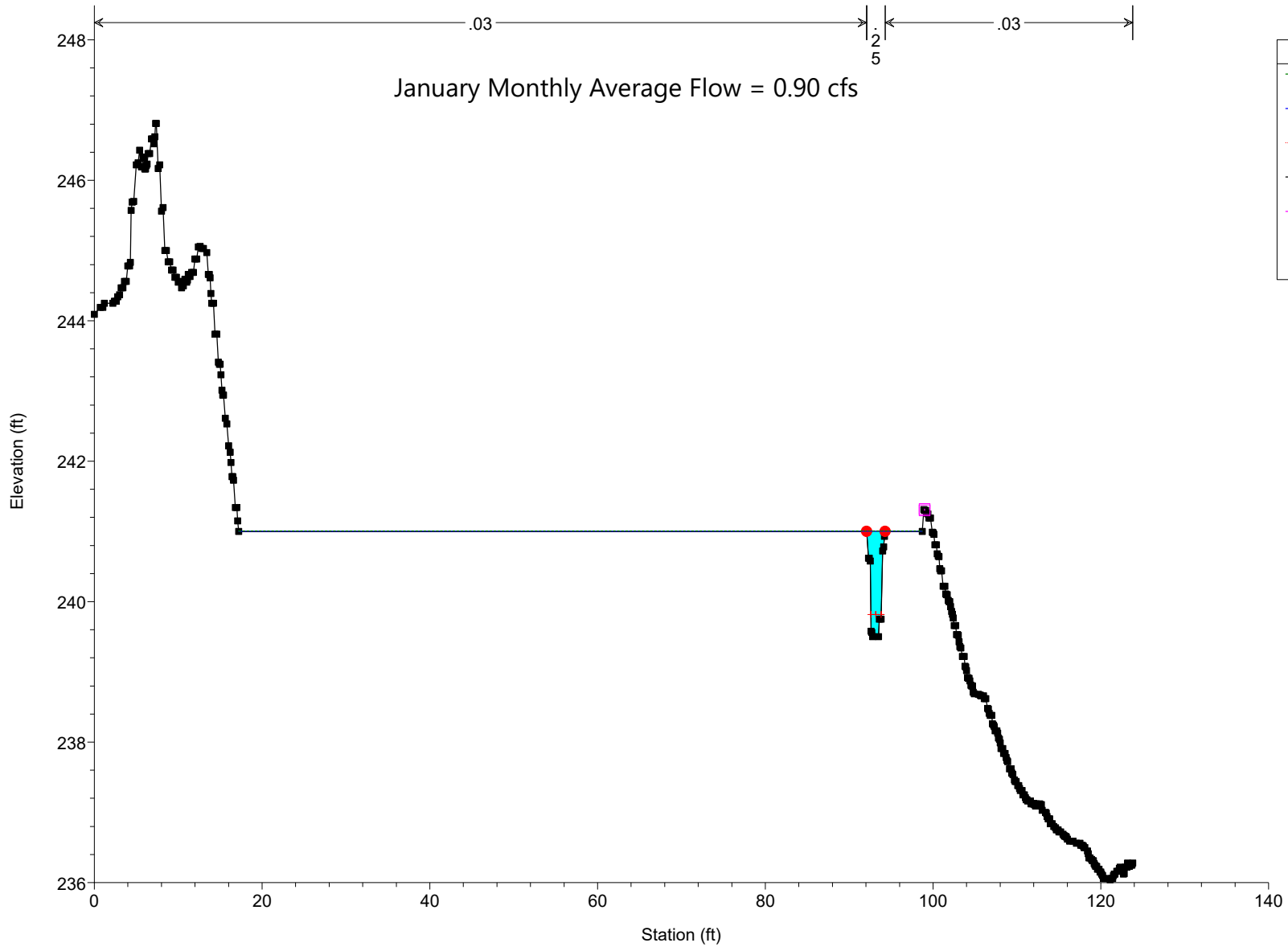
WattersQuarry2D_2.0 Plan: Plan 04 10/6/2023
RS = 855

January Monthly Average Flow = 0.90 cfs



WattersQuarry2D_2.0 Plan: Plan 04 10/6/2023
RS = 713

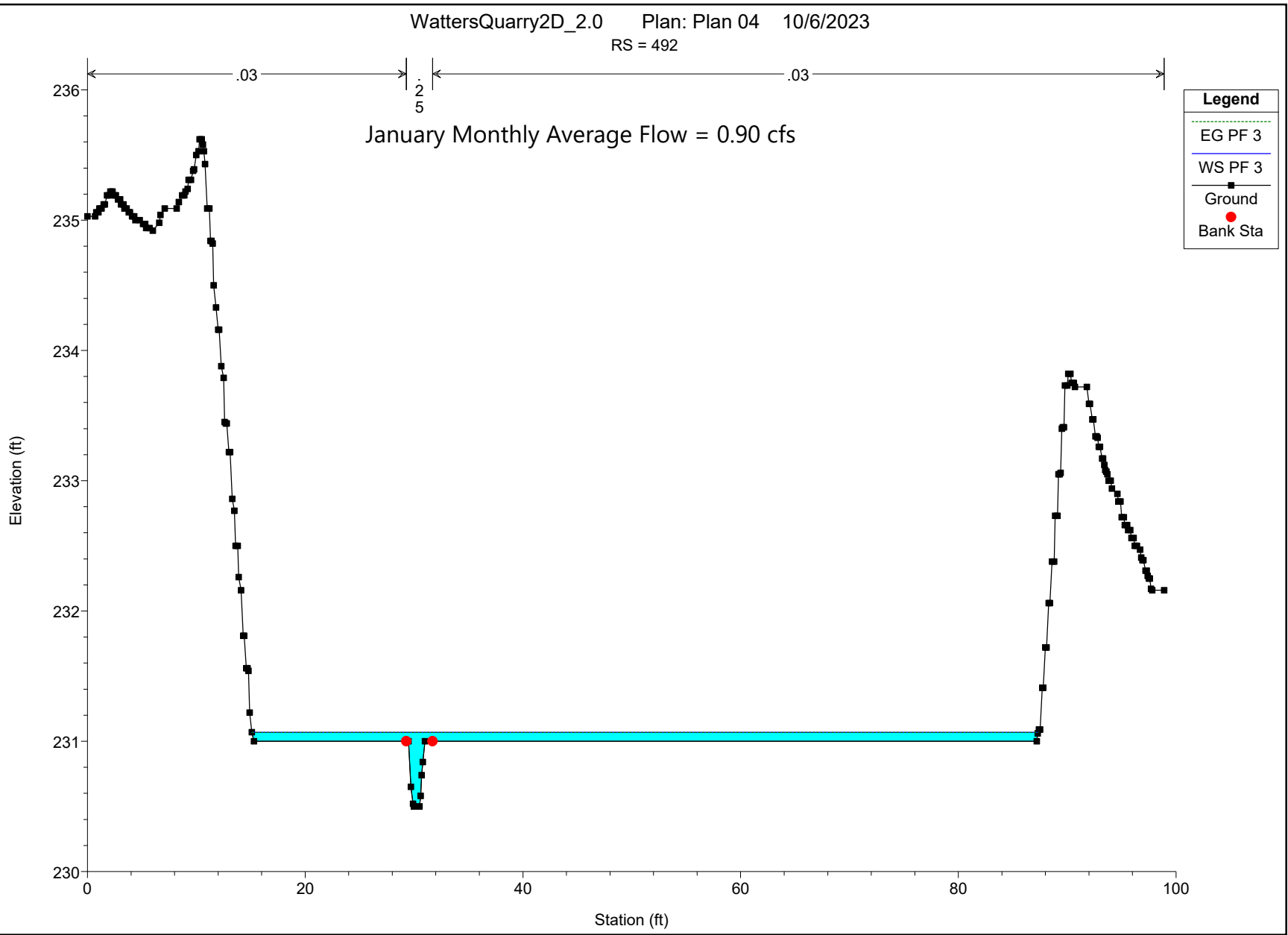
January Monthly Average Flow = 0.90 cfs



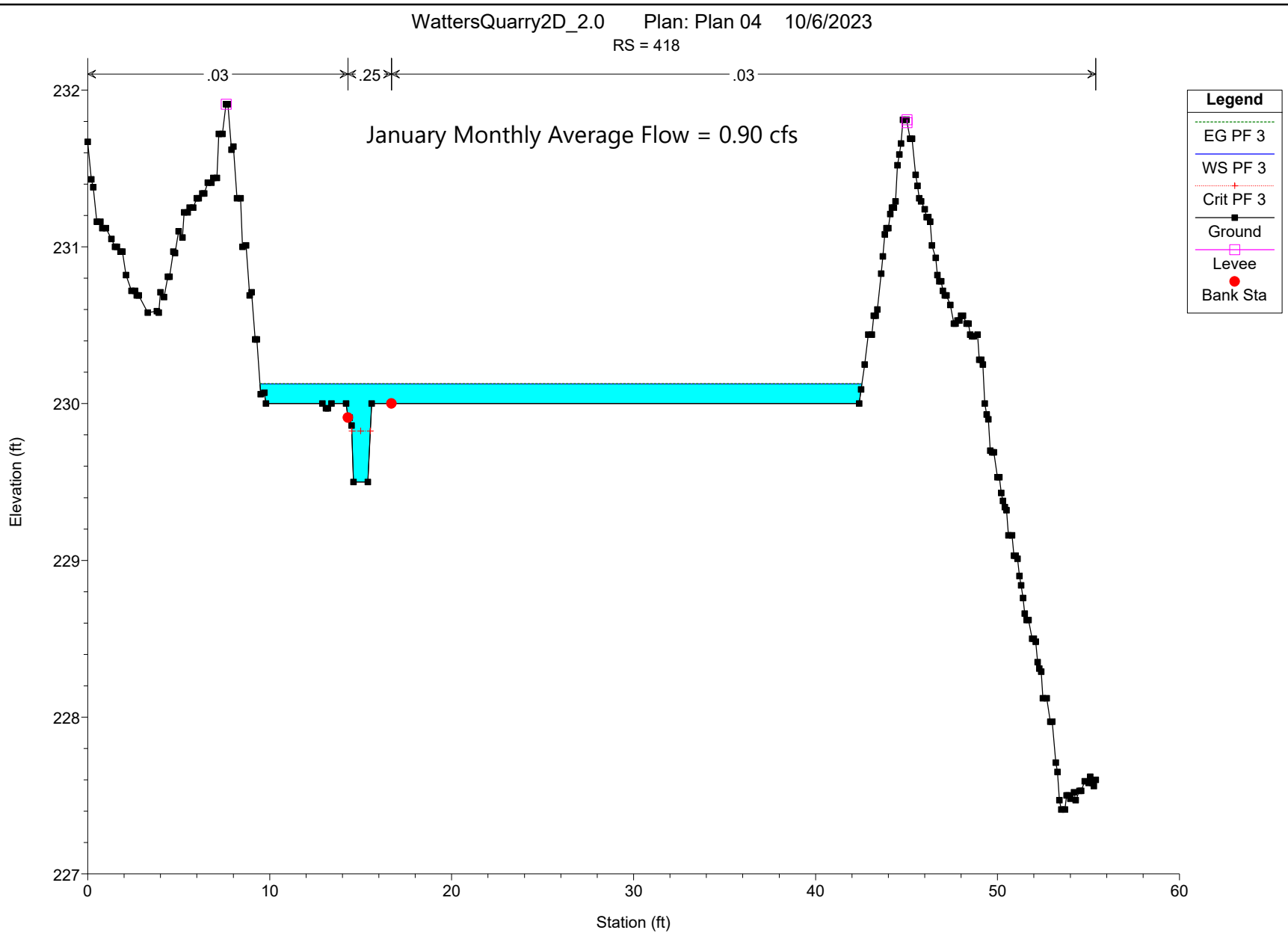
Legend	
EG PF 3	(dashed line)
WS PF 3	(solid line)
Crit PF 3	(dotted line)
Ground	(solid line)
Levee	(cyan bar)
Bank Sta	(red dot)

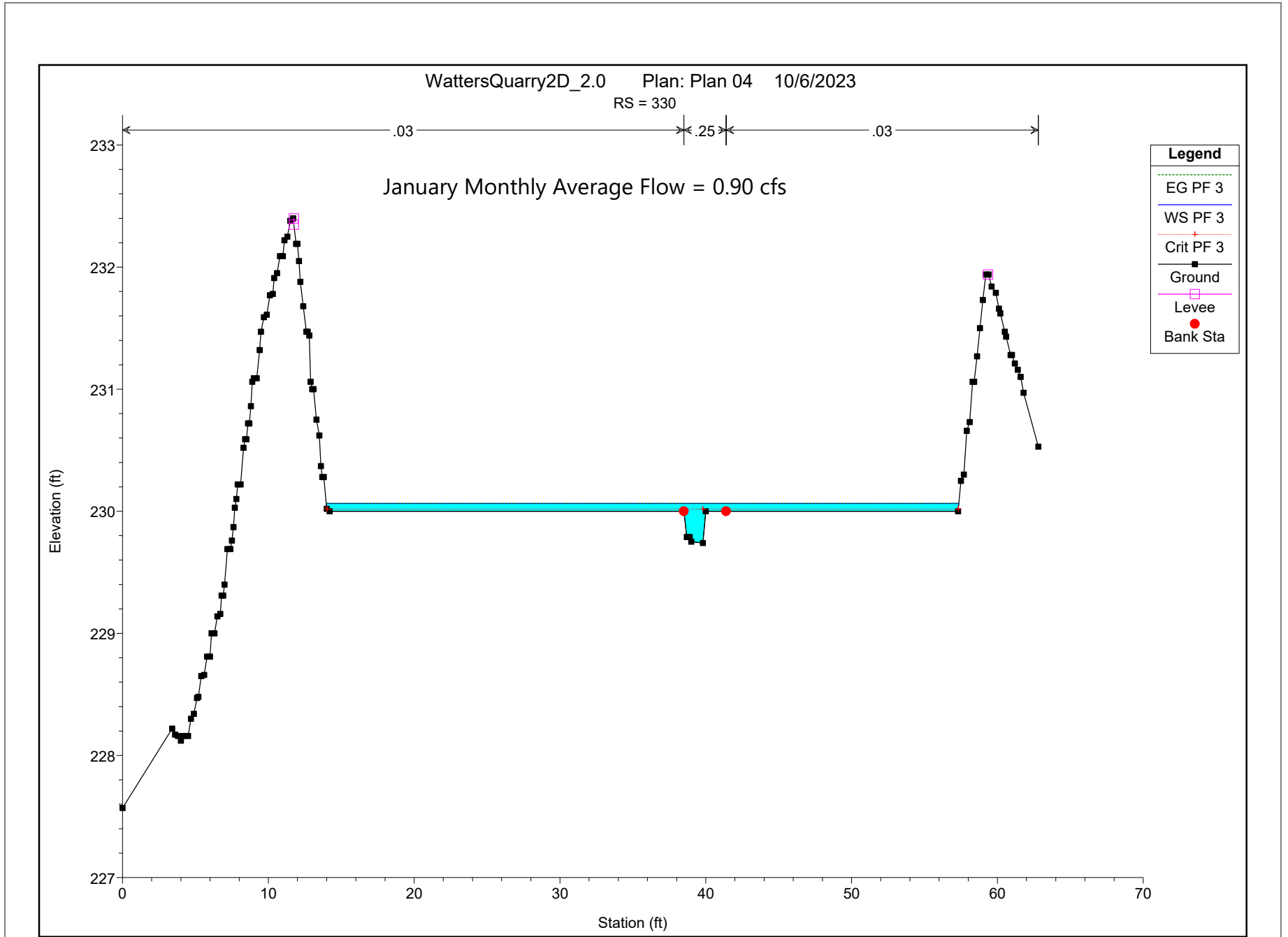
WattersQuarry2D_2.0 Plan: Plan 04 10/6/2023
RS = 492

January Monthly Average Flow = 0.90 cfs



WattersQuarry2D_2.0 Plan: Plan 04 10/6/2023
RS = 418

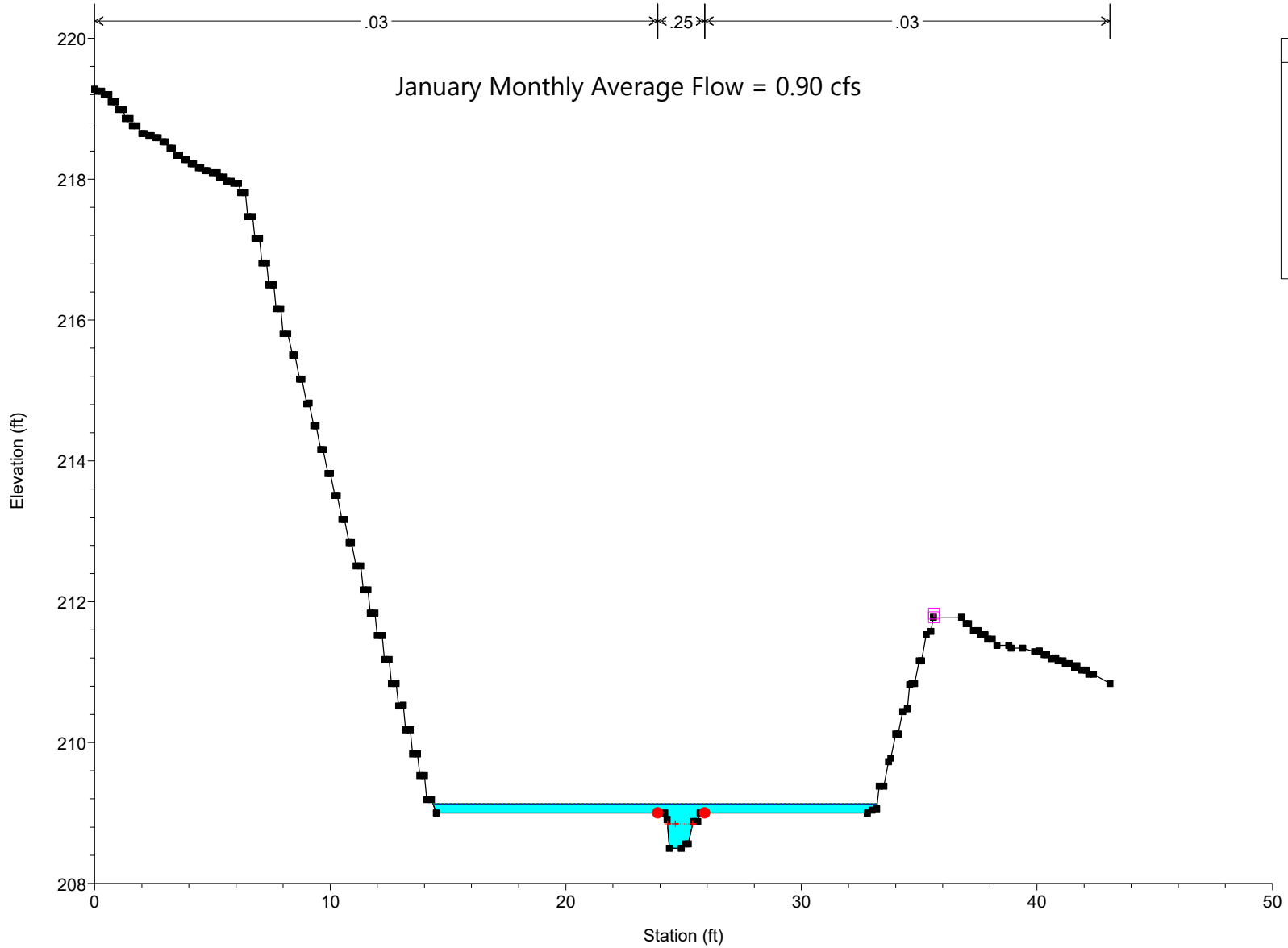


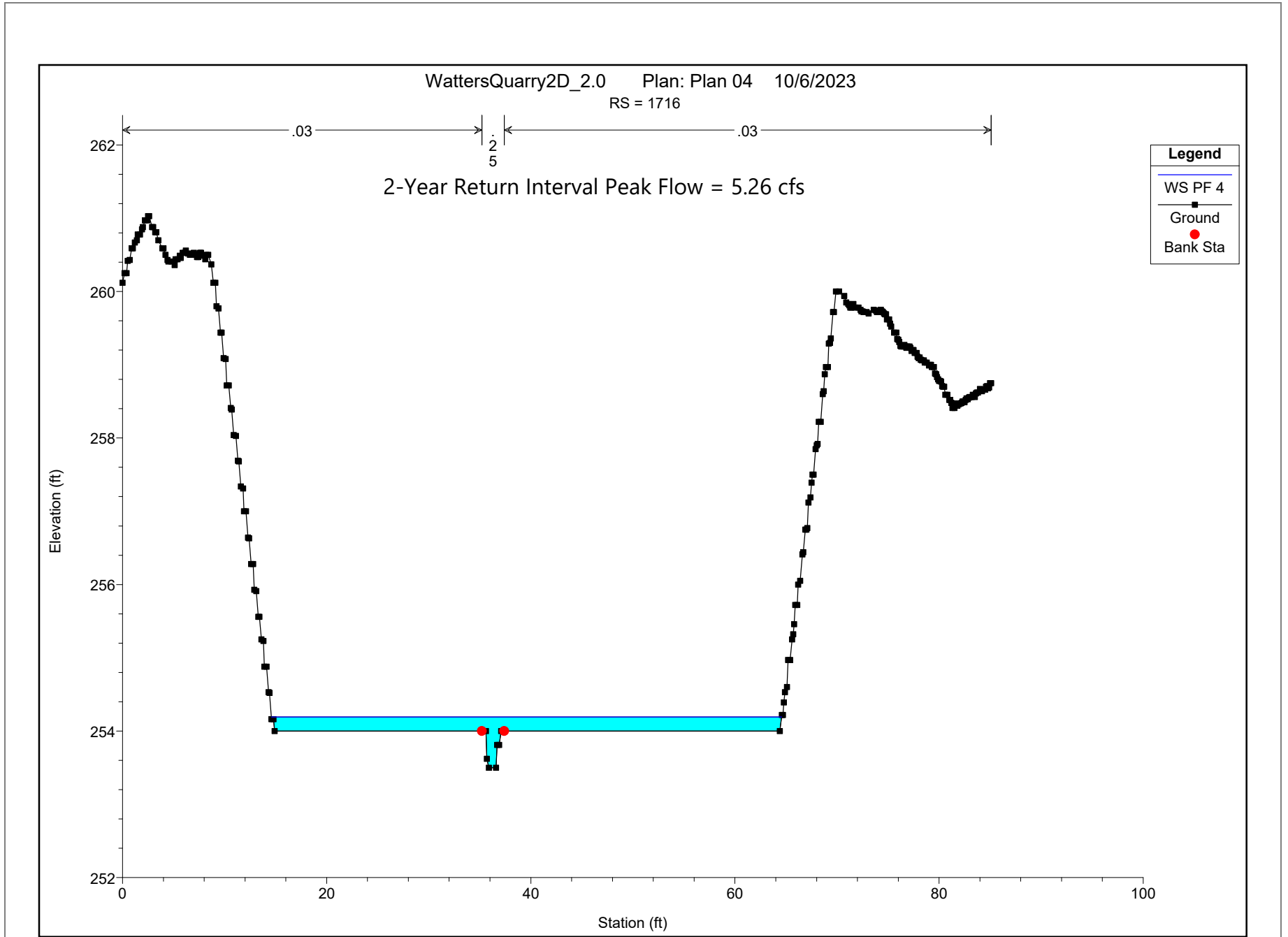


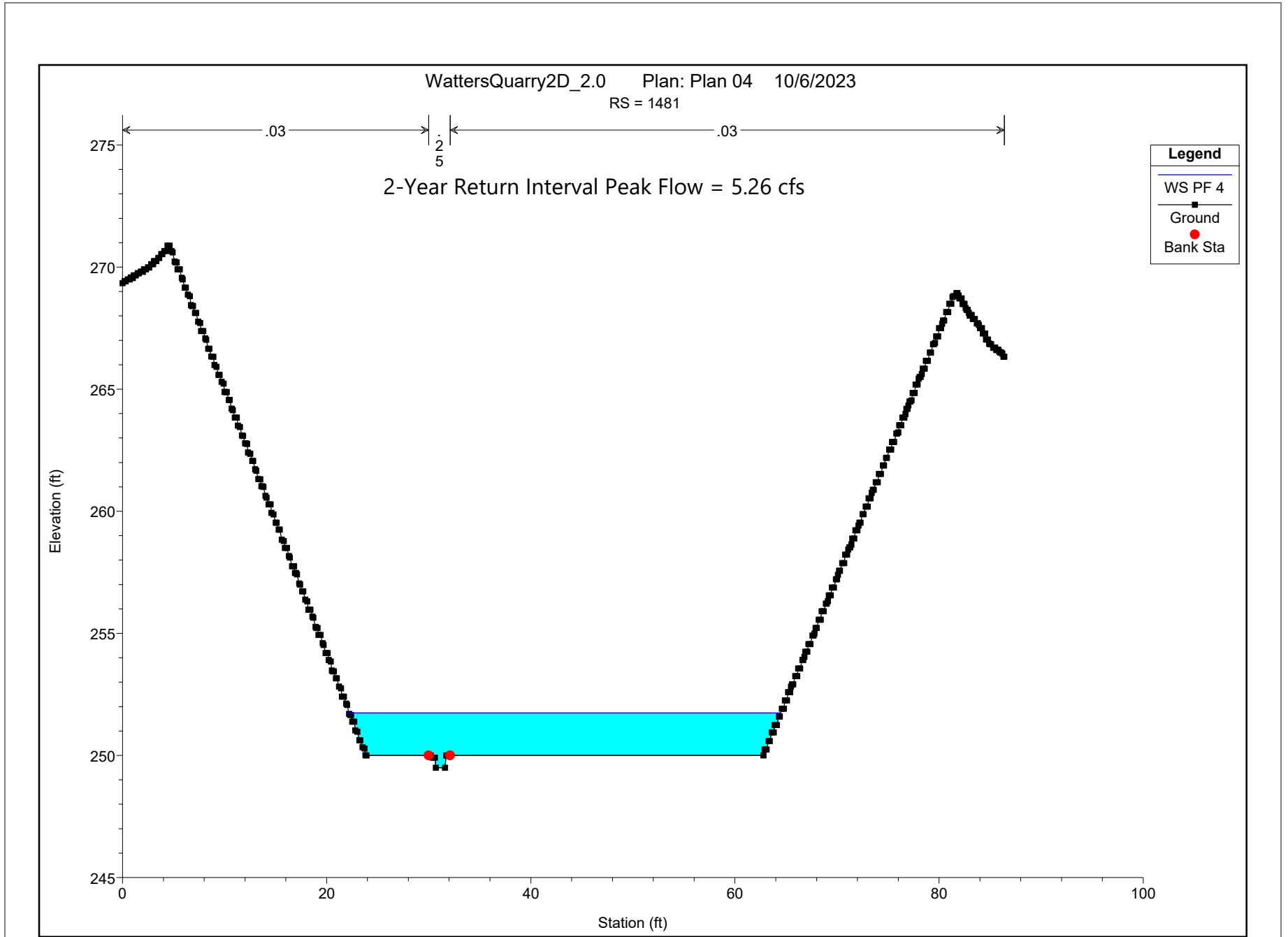
WattersQuarry2D_2.0 Plan: Plan 04 10/6/2023

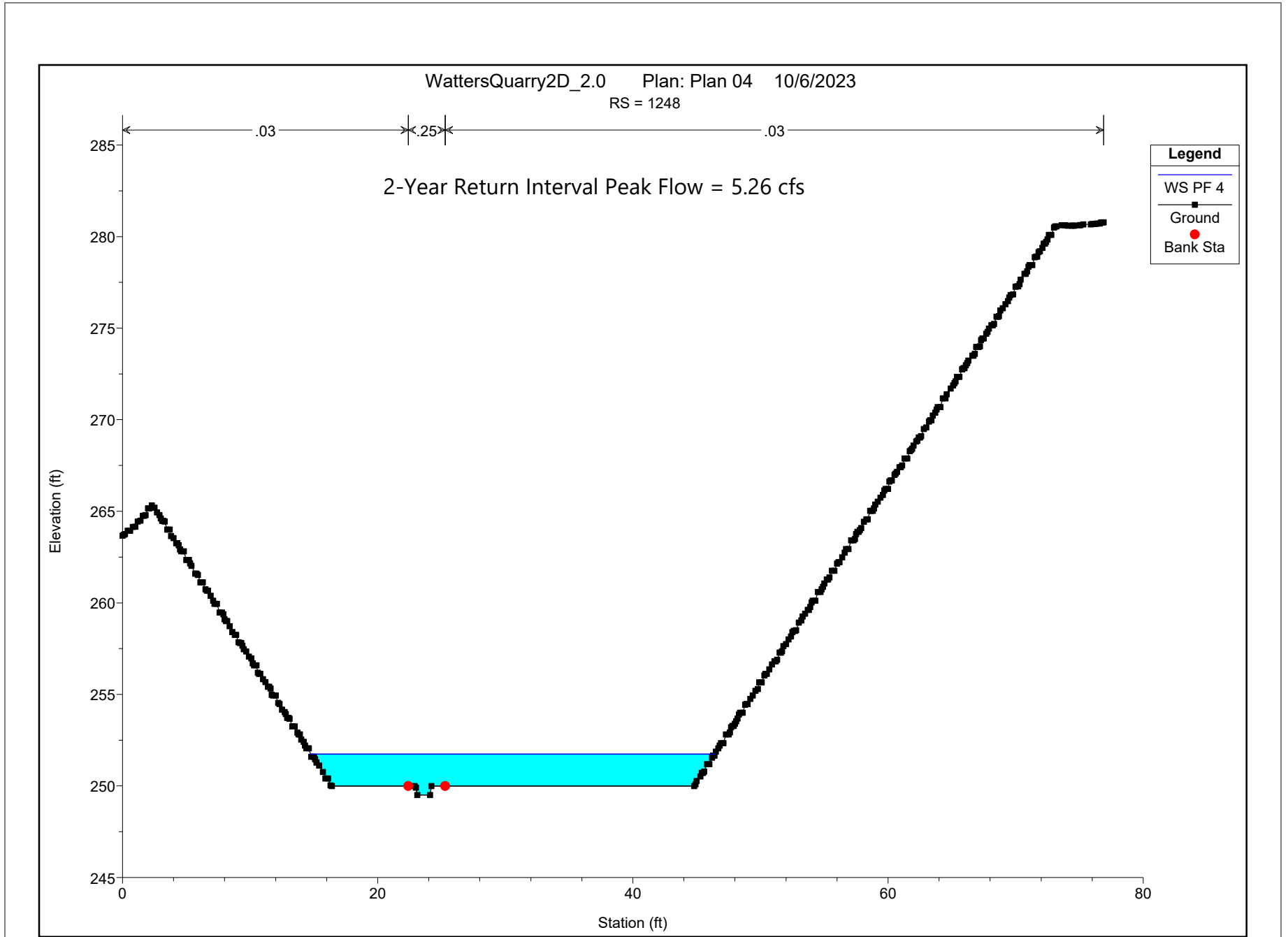
RS = 199

January Monthly Average Flow = 0.90 cfs

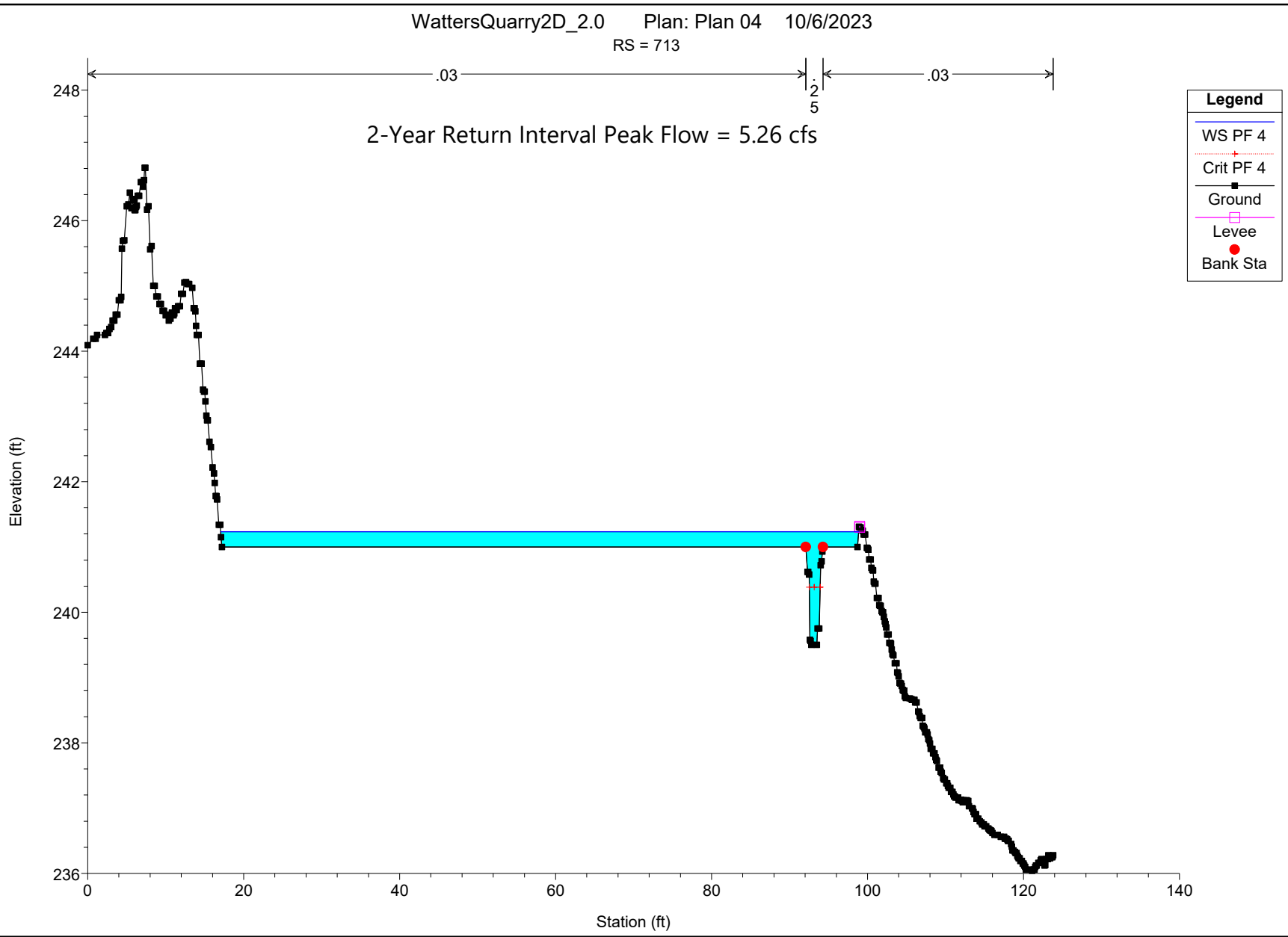




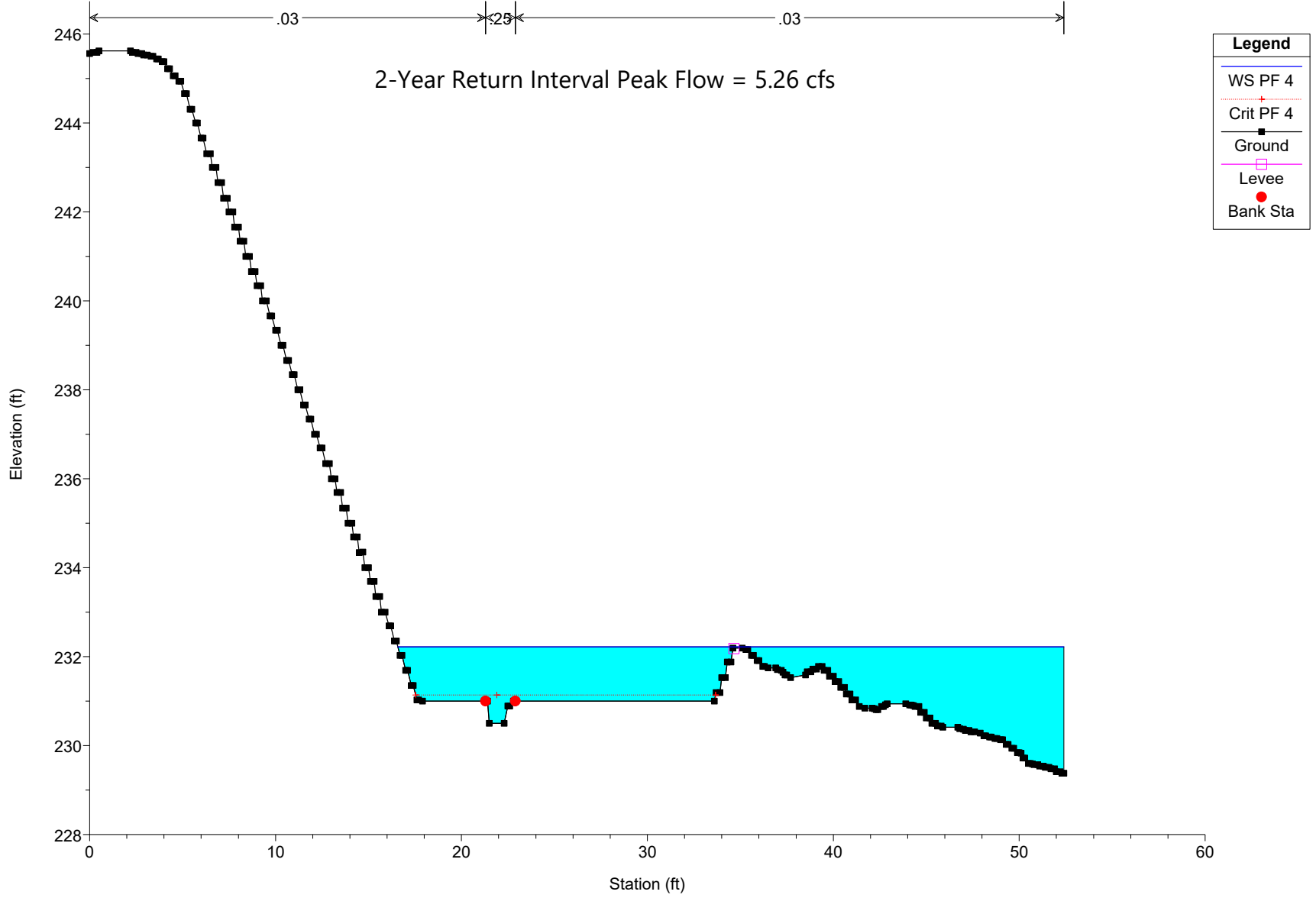


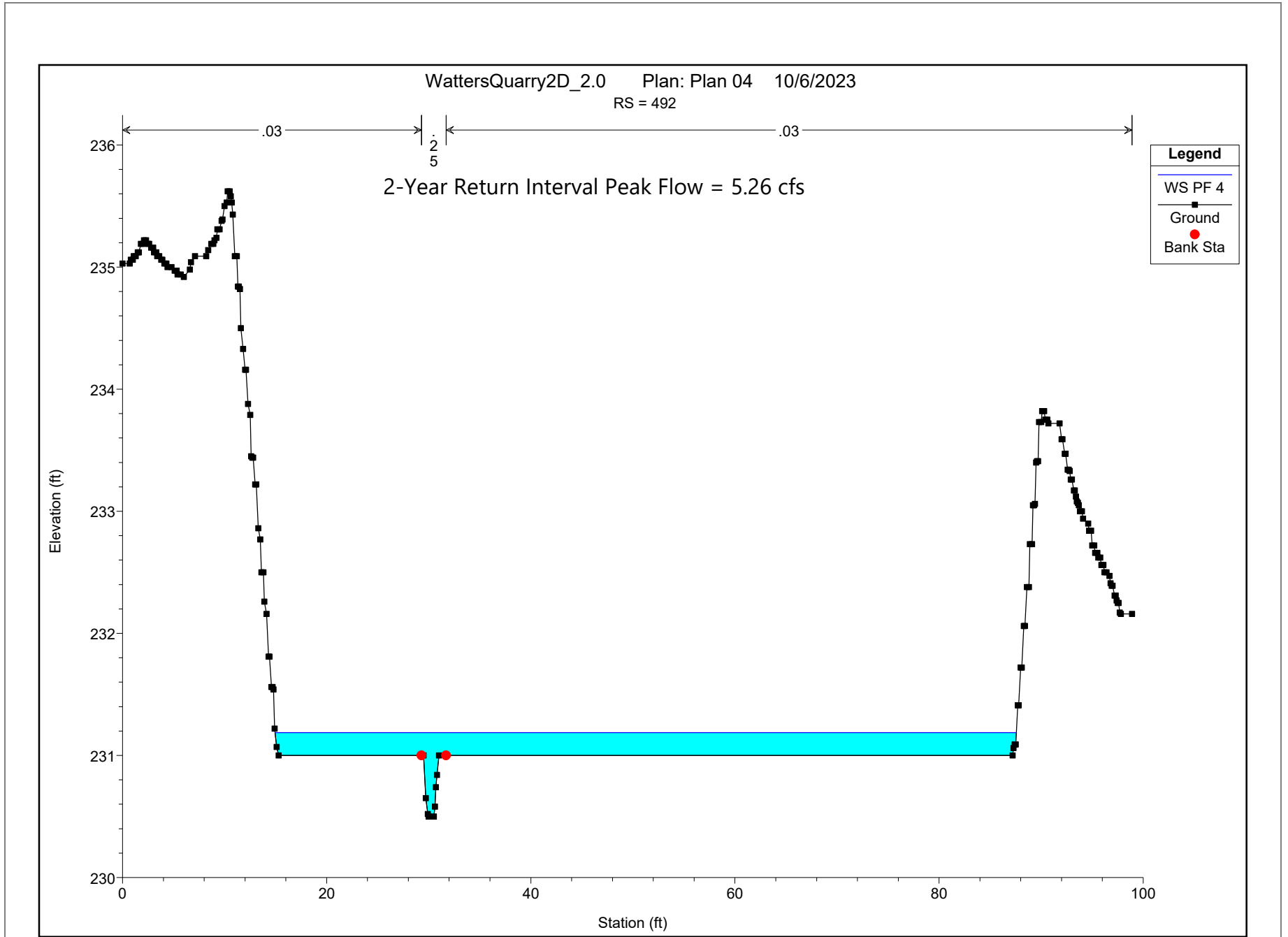


WattersQuarry2D_2.0 Plan: Plan 04 10/6/2023
RS = 713

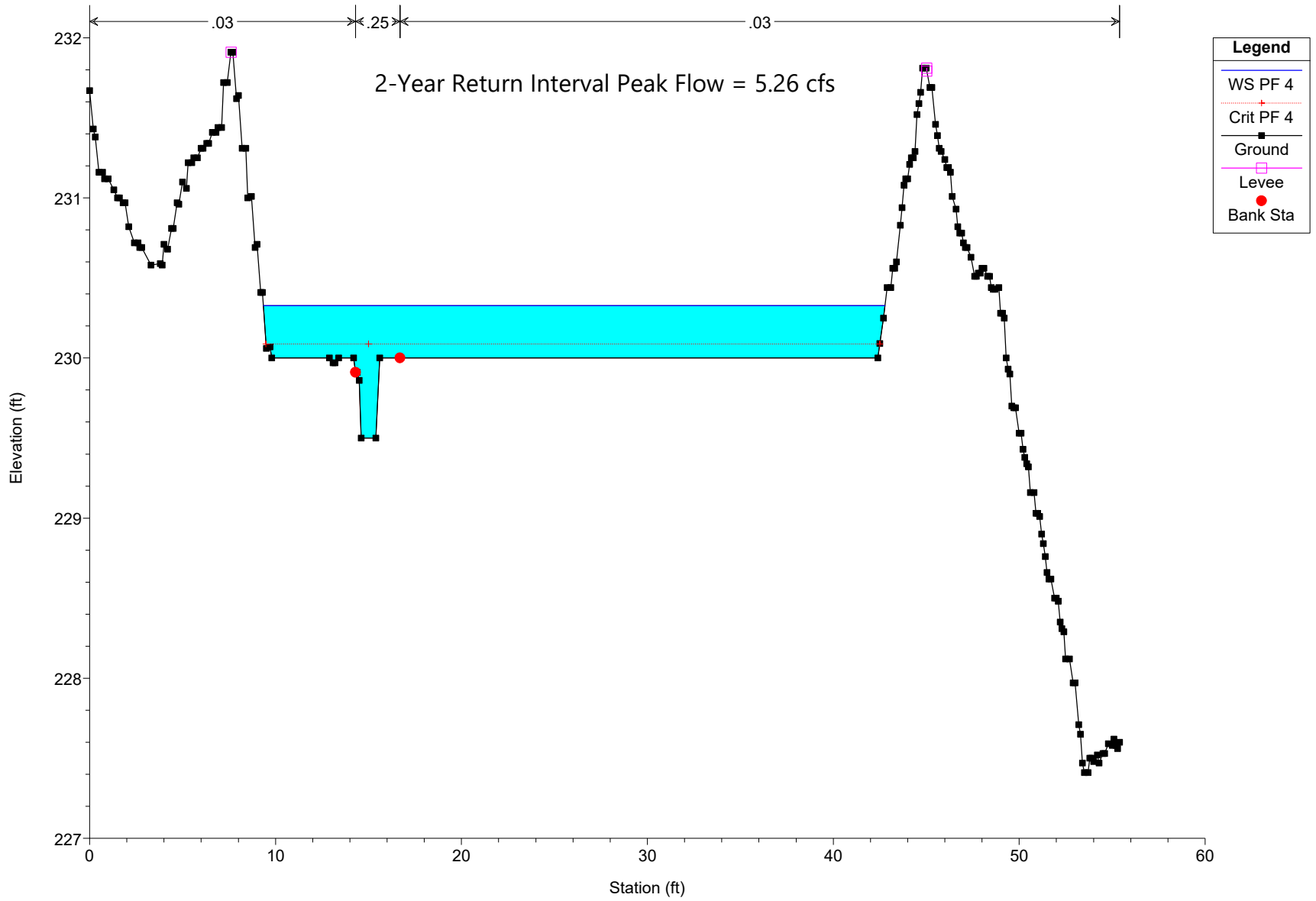


WattersQuarry2D_2.0 Plan: Plan 04 10/6/2023
RS = 584





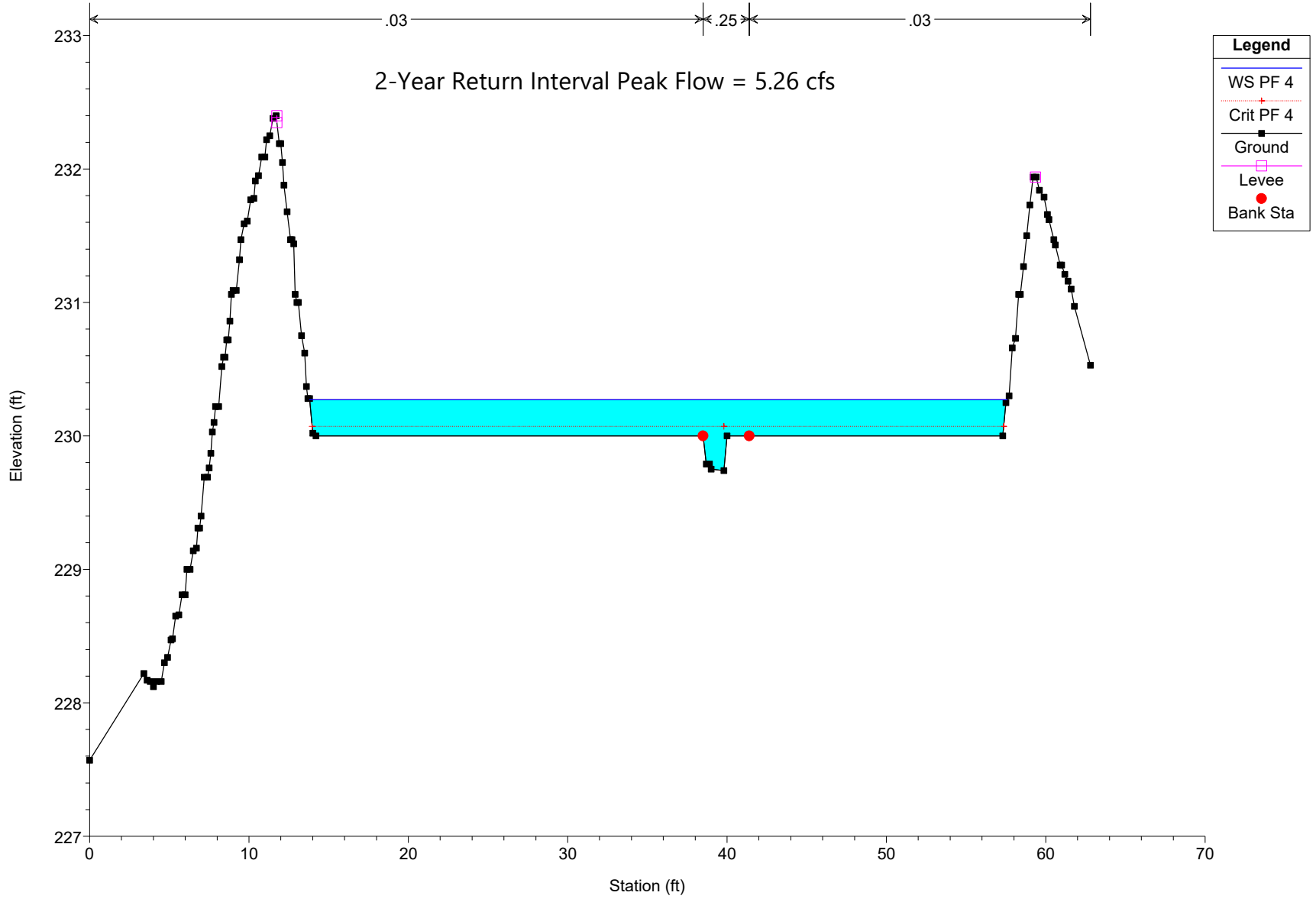
WattersQuarry2D_2.0 Plan: Plan 04 10/6/2023
RS = 418

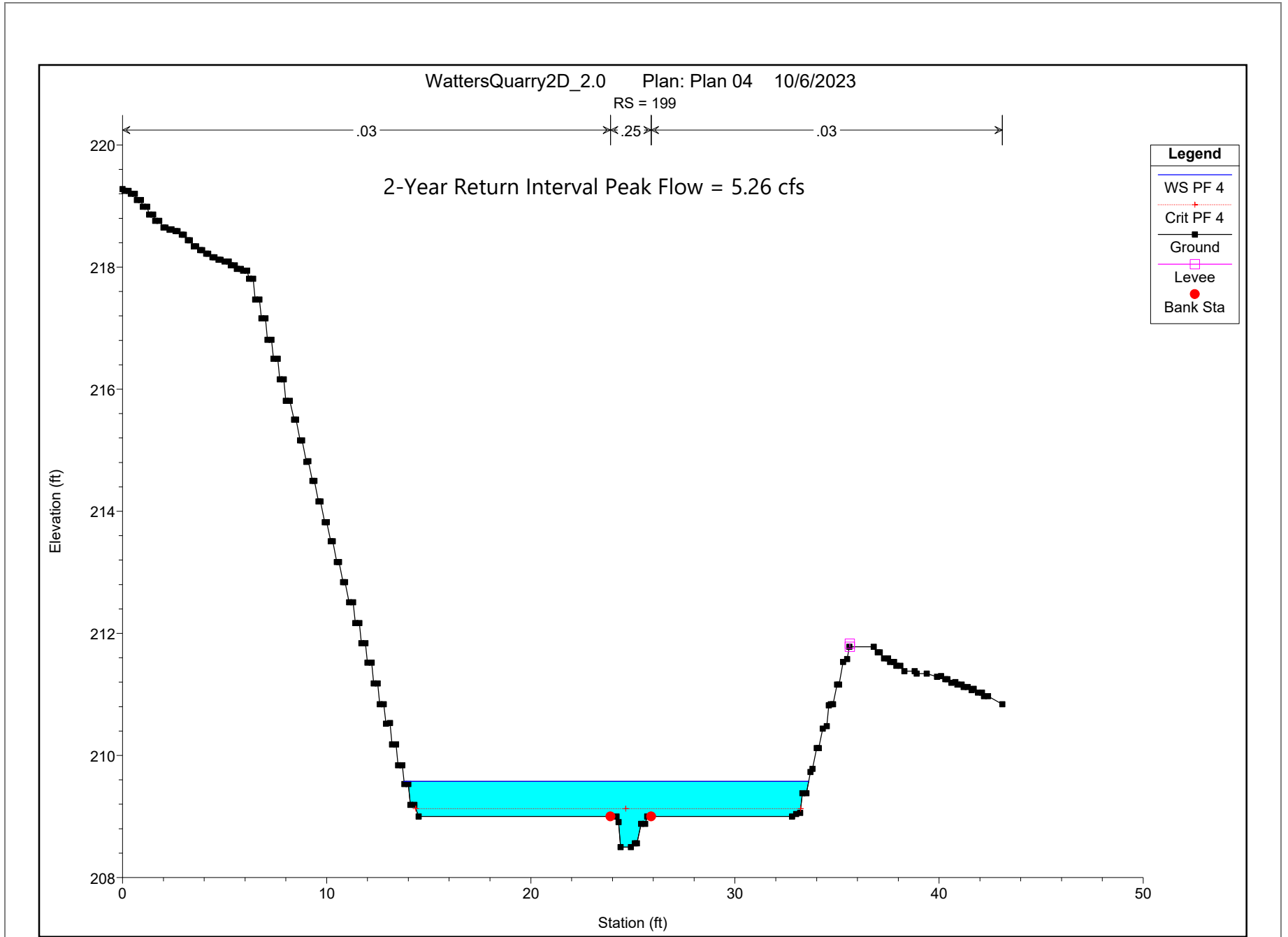


WattersQuarry2D_2.0 Plan: Plan 04 10/6/2023

RS = 330

2-Year Return Interval Peak Flow = 5.26 cfs





HEC-RAS Plan: Plan 04 River: R3RB1 Reach: Reach 1

Reach	River Sta	Profile	Q Total (cfs)	Min Ch El (ft)	W.S. Elev (ft)	Crit W.S. (ft)	E.G. Elev (ft)	E.G. Slope (ft/ft)	Vel Chnl (ft/s)	Flow Area (sq ft)	Top Width (ft)	Froude # Chl
Reach 1	1756	PF 1	0.05	267.75	267.83	267.83	267.85	0.042953	1.29	0.04	0.90	1.05
Reach 1	1756	PF 2	0.79	267.75	268.03	268.03	268.08	0.029956	1.76	0.45	4.67	1.00
Reach 1	1756	PF 3	0.90	267.75	268.04	268.04	268.09	0.031446	1.76	0.51	5.54	1.02
Reach 1	1756	PF 4	5.26	267.75	268.22	268.22	268.32	0.023308	2.51	2.10	10.69	1.00
Reach 1	1756	PF 5	15.23	267.75	268.42	268.42	268.60	0.018104	3.42	4.57	13.19	0.98
Reach 1	1745	PF 1	0.05	265.72	265.79	265.79	265.81	0.043126	1.01	0.05	1.74	1.01
Reach 1	1745	PF 2	0.79	265.72	265.90	265.90	265.96	0.029971	1.88	0.42	4.00	1.02
Reach 1	1745	PF 3	0.90	265.72	265.92	265.92	265.97	0.030908	1.95	0.46	4.27	1.04
Reach 1	1745	PF 4	5.26	265.72	266.15	266.15	266.29	0.020464	3.07	1.73	6.09	0.99
Reach 1	1745	PF 5	15.23	265.72	266.46	266.46	266.70	0.013443	4.03	4.19	10.16	0.90
Reach 1	1728	PF 1	0.05	253.50	253.95		253.95	0.004194	0.14	0.40	1.41	0.05
Reach 1	1728	PF 2	0.79	253.50	254.08		254.08	0.000903	0.07	3.36	36.12	0.02
Reach 1	1728	PF 3	0.90	253.50	254.09		254.09	0.000961	0.07	3.54	36.13	0.02
Reach 1	1728	PF 4	5.26	253.50	254.21		254.22	0.001790	0.12	7.99	36.31	0.03
Reach 1	1728	PF 5	15.23	253.50	264.52		264.52	0.000000	0.00	550.68	77.80	0.00
Reach 1	1716	PF 1	0.05	253.50	253.90		253.90	0.004094	0.14	0.40	1.36	0.04
Reach 1	1716	PF 2	0.79	253.50	254.07		254.07	0.000693	0.06	4.06	49.61	0.02
Reach 1	1716	PF 3	0.90	253.50	254.08		254.08	0.000737	0.06	4.28	49.62	0.02
Reach 1	1716	PF 4	5.26	253.50	254.19		254.20	0.001198	0.10	10.08	49.99	0.03
Reach 1	1716	PF 5	15.23	253.50	264.52		264.52	0.000000	0.00	723.45	85.10	0.00
Reach 1	1693	PF 1	0.05	253.50	253.69		253.69	0.029376	0.28	0.19	1.07	0.12
Reach 1	1693	PF 2	0.79	253.50	254.02	253.77	254.03	0.033448	0.40	1.39	38.52	0.13
Reach 1	1693	PF 3	0.90	253.50	254.02		254.03	0.032381	0.39	1.49	38.52	0.13
Reach 1	1693	PF 4	5.26	253.50	254.07	254.07	254.12	0.046155	0.52	3.35	38.58	0.15
Reach 1	1693	PF 5	15.23	253.50	264.52		264.52	0.000000	0.00	652.49	67.60	0.00
Reach 1	1670	PF 1	0.05	251.75	251.83	251.83	251.87	0.640290	1.49	0.04	0.74	1.18
Reach 1	1670	PF 2	0.79	251.75	252.09	252.09	252.23	0.356957	2.93	0.27	1.01	1.00
Reach 1	1670	PF 3	0.90	251.75	252.12	252.12	252.26	0.360732	3.05	0.30	1.03	1.00
Reach 1	1670	PF 4	5.26	251.75	252.69	252.69	253.08	0.420661	4.97	1.06	1.43	1.02
Reach 1	1670	PF 5	15.23	251.75	264.52		264.52	0.000000	0.01	503.74	46.80	0.00
Reach 1	1640	PF 1	0.05	249.50	250.06		250.06	0.000201	0.03	0.98	8.14	0.01
Reach 1	1640	PF 2	0.79	249.50	250.23		250.23	0.000837	0.09	2.37	8.26	0.02
Reach 1	1640	PF 3	0.90	249.50	250.24		250.25	0.000869	0.09	2.51	8.28	0.02
Reach 1	1640	PF 4	5.26	249.50	251.74		251.74	0.000016	0.03	32.60	33.10	0.00
Reach 1	1640	PF 5	15.23	249.50	264.52		264.52	0.000000	0.00	777.63	60.90	0.00
Reach 1	1623	PF 1	0.05	249.50	250.05		250.05	0.000202	0.03	0.97	8.23	0.01
Reach 1	1623	PF 2	0.79	249.50	250.21		250.21	0.000933	0.09	2.28	8.40	0.02
Reach 1	1623	PF 3	0.90	249.50	250.23		250.23	0.000998	0.10	2.42	8.61	0.02
Reach 1	1623	PF 4	5.26	249.50	251.74		251.74	0.000037	0.04	20.04	19.35	0.01
Reach 1	1623	PF 5	15.23	249.50	264.52		264.52	0.000000	0.00	663.89	54.30	0.00
Reach 1	1601	PF 1	0.05	249.50	250.05		250.05	0.000276	0.04	0.92	8.46	0.01
Reach 1	1601	PF 2	0.79	249.50	250.18		250.19	0.001407	0.10	2.10	8.63	0.03
Reach 1	1601	PF 3	0.90	249.50	250.20		250.20	0.001447	0.11	2.22	8.65	0.03
Reach 1	1601	PF 4	5.26	249.50	251.74		251.74	0.000040	0.05	18.08	11.89	0.01
Reach 1	1601	PF 5	15.23	249.50	264.52		264.52	0.000000	0.01	411.63	34.10	0.00
Reach 1	1570	PF 1	0.05	249.50	250.04		250.04	0.000055	0.01	1.56	25.45	0.01
Reach 1	1570	PF 2	0.79	249.50	250.18		250.18	0.000142	0.03	4.98	25.68	0.01
Reach 1	1570	PF 3	0.90	249.50	250.19		250.19	0.000143	0.03	5.36	25.80	0.01
Reach 1	1570	PF 4	5.26	249.50	251.74		251.74	0.000003	0.01	47.48	28.70	0.00
Reach 1	1570	PF 5	15.23	249.50	264.52		264.52	0.000000	0.00	581.95	47.40	0.00
Reach 1	1524	PF 1	0.05	249.50	250.04		250.04	0.000054	0.02	1.60	27.73	0.01
Reach 1	1524	PF 2	0.79	249.50	250.17		250.17	0.000130	0.03	5.23	28.13	0.01
Reach 1	1524	PF 3	0.90	249.50	250.19		250.19	0.000128	0.03	5.65	28.16	0.01
Reach 1	1524	PF 4	5.26	249.50	251.74		251.74	0.000003	0.01	51.57	30.93	0.00
Reach 1	1524	PF 5	15.23	249.50	264.52		264.52	0.000000	0.00	650.62	58.30	0.00
Reach 1	1481	PF 1	0.05	249.50	250.04		250.04	0.000031	0.01	2.07	39.03	0.00
Reach 1	1481	PF 2	0.79	249.50	250.17		250.17	0.000069	0.02	7.07	39.13	0.01
Reach 1	1481	PF 3	0.90	249.50	250.18		250.18	0.000068	0.02	7.65	39.14	0.01
Reach 1	1481	PF 4	5.26	249.50	251.74		251.74	0.000001	0.01	71.13	42.32	0.00
Reach 1	1481	PF 5	15.23	249.50	264.52		264.52	0.000000	0.00	767.33	66.72	0.00
Reach 1	1402	PF 1	0.05	249.50	250.04		250.04	0.000025	0.01	2.34	48.87	0.00
Reach 1	1402	PF 2	0.79	249.50	250.16		250.16	0.000048	0.02	8.49	49.09	0.01
Reach 1	1402	PF 3	0.90	249.50	250.18		250.18	0.000047	0.02	9.23	49.13	0.01
Reach 1	1402	PF 4	5.26	249.50	251.74		251.74	0.000001	0.01	88.31	52.06	0.00

HEC-RAS Plan: Plan 04 River: R3RB1 Reach: Reach 1 (Continued)

Reach	River Sta	Profile	Q Total (cfs)	Min Ch El (ft)	W.S. Elev (ft)	Crit W.S. (ft)	E.G. Elev (ft)	E.G. Slope (ft/ft)	Vel Chnl (ft/s)	Flow Area (sq ft)	Top Width (ft)	Froude # Chl
Reach 1	1402	PF 5	15.23	249.50	264.52		264.52	0.000000	0.00	904.80	75.68	0.00
Reach 1	1356	PF 1	0.05	249.50	250.04		250.04	0.000052	0.01	1.76	35.49	0.01
Reach 1	1356	PF 2	0.79	249.50	250.16		250.16	0.000100	0.03	6.18	35.90	0.01
Reach 1	1356	PF 3	0.90	249.50	250.17		250.18	0.000096	0.03	6.73	35.98	0.01
Reach 1	1356	PF 4	5.26	249.50	251.74		251.74	0.000002	0.01	65.22	38.88	0.00
Reach 1	1356	PF 5	15.23	249.50	264.52		264.52	0.000000	0.00	710.94	62.13	0.00
Reach 1	1294	PF 1	0.05	249.50	250.03		250.03	0.000080	0.02	1.60	34.21	0.01
Reach 1	1294	PF 2	0.79	249.50	250.15		250.15	0.000130	0.03	5.73	34.37	0.01
Reach 1	1294	PF 3	0.90	249.50	250.17		250.17	0.000123	0.03	6.26	34.38	0.01
Reach 1	1294	PF 4	5.26	249.50	251.74		251.74	0.000002	0.01	62.48	37.23	0.00
Reach 1	1294	PF 5	15.23	249.50	264.52		264.52	0.000000	0.00	690.47	61.41	0.00
Reach 1	1248	PF 1	0.05	249.50	250.03		250.03	0.000148	0.02	1.36	28.52	0.01
Reach 1	1248	PF 2	0.79	249.50	250.15		250.15	0.000222	0.04	4.70	28.69	0.01
Reach 1	1248	PF 3	0.90	249.50	250.16		250.16	0.000206	0.04	5.16	28.71	0.01
Reach 1	1248	PF 4	5.26	249.50	251.74		251.74	0.000003	0.01	52.76	31.70	0.00
Reach 1	1248	PF 5	15.23	249.50	264.52		264.52	0.000000	0.00	607.81	56.59	0.00
Reach 1	1196	PF 1	0.05	249.50	250.01	249.55	250.01	0.001878	0.08	0.69	19.65	0.03
Reach 1	1196	PF 2	0.79	249.50	250.13	249.78	250.13	0.000775	0.07	3.01	19.85	0.02
Reach 1	1196	PF 3	0.90	249.50	250.14	249.80	250.14	0.000669	0.06	3.35	19.87	0.02
Reach 1	1196	PF 4	5.26	249.50	251.74	250.12	251.74	0.000006	0.02	37.42	22.76	0.00
Reach 1	1196	PF 5	15.23	249.50	264.52	250.28	264.52	0.000000	0.00	638.49	51.21	0.00
Reach 1	1137	PF 1	0.05	249.50	249.55	249.55	249.58	3.283746	1.39	0.04	0.80	1.11
Reach 1	1137	PF 2	0.79	249.50	249.80	249.80	249.93	2.144767	2.92	0.27	1.00	0.99
Reach 1	1137	PF 3	0.90	249.50	249.83	249.83	249.97	2.214233	3.06	0.29	1.01	1.00
Reach 1	1137	PF 4	5.26	249.50	250.01	250.01	251.58	25.727990	9.65	0.53	3.91	3.46
Reach 1	1137	PF 5	15.23	249.50	250.02	250.02	263.20	189.529500	26.51	0.55	3.94	9.42
Reach 1	1111	PF 1	0.05	240.25	240.40	240.30	240.40	0.001019	0.37	0.15	1.07	0.18
Reach 1	1111	PF 2	0.79	240.25	241.17	240.52	241.17	0.000102	0.24	3.27	8.69	0.07
Reach 1	1111	PF 3	0.90	240.25	241.17	240.54	241.17	0.000127	0.27	3.32	8.70	0.08
Reach 1	1111	PF 4	5.26	240.25	241.51	241.01	241.52	0.000146	0.43	13.74	26.12	0.09
Reach 1	1111	PF 5	15.23	240.25	242.17	241.25	242.18	0.000089	0.53	32.81	33.45	0.08
Reach 1	1085	PF 1	0.05	240.09	240.25	240.25	240.31	0.064296	1.94	0.03	0.25	1.03
Reach 1	1085	PF 2	0.79	240.09	241.16		241.16	0.000779	0.64	1.44	6.67	0.15
Reach 1	1085	PF 3	0.90	240.09	241.16		241.17	0.000993	0.72	1.46	6.72	0.17
Reach 1	1085	PF 4	5.26	240.09	241.49		241.51	0.002308	1.31	4.91	15.79	0.29
Reach 1	1085	PF 5	15.23	240.09	242.16		242.17	0.000468	0.95	19.39	29.56	0.15
Reach 1	1062	PF 1	0.05	239.66	240.09		240.09	0.000040	0.12	0.45	1.21	0.03
Reach 1	1062	PF 2	0.79	239.66	241.15		241.15	0.000157	0.38	2.07	1.83	0.06
Reach 1	1062	PF 3	0.90	239.66	241.15		241.16	0.000204	0.43	2.07	1.83	0.07
Reach 1	1062	PF 4	5.26	239.66	241.35		241.42	0.004513	2.15	2.45	1.89	0.33
Reach 1	1062	PF 5	15.23	239.66	241.79		242.11	0.017347	4.55	3.35	2.22	0.65
Reach 1	1037	PF 1	0.05	239.50	240.09		240.09	0.000021	0.01	1.75	14.37	0.00
Reach 1	1037	PF 2	0.79	239.50	241.15		241.15	0.000001	0.01	18.15	16.48	0.00
Reach 1	1037	PF 3	0.90	239.50	241.16		241.16	0.000002	0.01	18.17	16.48	0.00
Reach 1	1037	PF 4	5.26	239.50	241.40		241.40	0.000027	0.04	22.25	17.04	0.00
Reach 1	1037	PF 5	15.23	239.50	242.00		242.01	0.000072	0.07	32.81	18.24	0.01
Reach 1	982	PF 1	0.05	239.56	240.09		240.09	0.000006	0.01	2.66	26.36	0.00
Reach 1	982	PF 2	0.79	239.56	241.15		241.15	0.000000	0.00	31.79	28.37	0.00
Reach 1	982	PF 3	0.90	239.56	241.16		241.16	0.000000	0.00	31.83	28.37	0.00
Reach 1	982	PF 4	5.26	239.56	241.40		241.40	0.000006	0.02	38.81	28.72	0.00
Reach 1	982	PF 5	15.23	239.56	242.00		242.00	0.000016	0.03	56.57	29.95	0.00
Reach 1	947	PF 1	0.05	239.50	240.09		240.09	0.000010	0.01	2.34	20.24	0.00
Reach 1	947	PF 2	0.79	239.50	241.15		241.15	0.000001	0.00	24.99	22.18	0.00
Reach 1	947	PF 3	0.90	239.50	241.16		241.16	0.000001	0.01	25.03	22.18	0.00
Reach 1	947	PF 4	5.26	239.50	241.40		241.40	0.000012	0.02	30.52	22.74	0.00
Reach 1	947	PF 5	15.23	239.50	242.00		242.00	0.000031	0.05	44.52	23.92	0.01
Reach 1	922	PF 1	0.05	239.50	240.09		240.09	0.001335	0.09	0.60	1.36	0.02
Reach 1	922	PF 2	0.79	239.50	241.15		241.15	0.008108	0.34	2.31	1.97	0.06
Reach 1	922	PF 3	0.90	239.50	241.15		241.15	0.010526	0.39	2.32	1.97	0.06
Reach 1	922	PF 4	5.26	239.50	241.33		241.39	0.245462	1.96	2.68	2.04	0.30
Reach 1	922	PF 5	15.23	239.50	241.66		241.97	1.137605	4.50	3.39	2.26	0.65
Reach 1	894	PF 1	0.05	239.50	240.09		240.09	0.000005	0.01	3.01	29.33	0.00
Reach 1	894	PF 2	0.79	239.50	241.15		241.15	0.000000	0.00	35.41	31.38	0.00

HEC-RAS Plan: Plan 04 River: R3RB1 Reach: Reach 1 (Continued)

Reach	River Sta	Profile	Q Total (cfs)	Min Ch El (ft)	W.S. Elev (ft)	Crit W.S. (ft)	E.G. Elev (ft)	E.G. Slope (ft/ft)	Vel Chnl (ft/s)	Flow Area (sq ft)	Top Width (ft)	Froude # Chl
Reach 1	894	PF 3	0.90	239.50	241.15		241.15	0.000000	0.00	35.45	31.38	0.00
Reach 1	894	PF 4	5.26	239.50	241.37		241.37	0.000005	0.02	42.41	31.91	0.00
Reach 1	894	PF 5	15.23	239.50	241.87		241.87	0.000017	0.03	58.50	32.92	0.00
Reach 1	855	PF 1	0.05	239.50	240.09		240.09	0.000004	0.00	3.35	33.18	0.00
Reach 1	855	PF 2	0.79	239.50	241.15		241.15	0.000000	0.00	39.96	35.36	0.00
Reach 1	855	PF 3	0.90	239.50	241.15		241.15	0.000000	0.00	40.00	35.36	0.00
Reach 1	855	PF 4	5.26	239.50	241.37		241.37	0.000004	0.01	47.79	35.57	0.00
Reach 1	855	PF 5	15.23	239.50	241.87		241.87	0.000013	0.03	65.77	36.66	0.00
Reach 1	827	PF 1	0.05	239.50	240.09		240.09	0.000901	0.08	0.67	1.33	0.02
Reach 1	827	PF 2	0.79	239.50	241.15		241.15	0.007906	0.34	2.33	1.95	0.05
Reach 1	827	PF 3	0.90	239.50	241.15		241.15	0.010270	0.39	2.33	1.95	0.06
Reach 1	827	PF 4	5.26	239.50	241.31		241.37	0.254114	1.99	2.64	2.01	0.31
Reach 1	827	PF 5	15.23	239.50	241.22	241.19	241.81	2.519645	6.16	2.47	1.98	0.97
Reach 1	767	PF 1	0.05	239.50	240.01	239.55	240.01	0.001732	0.10	0.52	1.22	0.03
Reach 1	767	PF 2	0.79	239.50	241.06	239.79	241.06	0.000584	0.09	5.27	51.51	0.02
Reach 1	767	PF 3	0.90	239.50	241.08	239.82	241.08	0.000452	0.08	5.98	51.52	0.01
Reach 1	767	PF 4	5.26	239.50	241.26	240.43	241.26	0.000400	0.08	15.25	51.96	0.01
Reach 1	767	PF 5	15.23	239.50	241.62	241.11	241.62	0.000030	0.03	62.26	68.33	0.00
Reach 1	735	PF 1	0.05	239.50	239.95	239.55	239.95	0.002077	0.11	0.48	1.23	0.03
Reach 1	735	PF 2	0.79	239.50	241.04	239.78	241.04	0.002165	0.17	3.82	47.27	0.03
Reach 1	735	PF 3	0.90	239.50	241.06	239.81	241.06	0.001147	0.13	4.75	47.31	0.02
Reach 1	735	PF 4	5.26	239.50	241.24	240.39	241.24	0.000582	0.10	13.54	47.87	0.02
Reach 1	735	PF 5	15.23	239.50	241.62	241.12	241.62	0.000227	0.08	31.72	48.54	0.01
Reach 1	713	PF 1	0.05	239.50	239.89	239.56	239.89	0.003882	0.13	0.40	1.26	0.04
Reach 1	713	PF 2	0.79	239.50	240.94	239.80	240.94	0.012031	0.39	2.01	2.09	0.07
Reach 1	713	PF 3	0.90	239.50	241.01	239.82	241.01	0.011426	0.39	2.55	81.51	0.07
Reach 1	713	PF 4	5.26	239.50	241.23	240.38	241.24	0.000211	0.06	21.31	81.80	0.01
Reach 1	713	PF 5	15.23	239.50	241.62	241.08	241.62	0.000002	0.01	149.55	107.14	0.00
Reach 1	690	PF 1	0.05	239.50	239.68	239.55	239.68	0.041612	0.32	0.17	0.98	0.13
Reach 1	690	PF 2	0.79	239.50	240.33	239.78	240.34	0.094796	0.89	0.89	1.27	0.19
Reach 1	690	PF 3	0.90	239.50	240.39	239.80	240.41	0.103504	0.92	0.97	1.49	0.20
Reach 1	690	PF 4	5.26	239.50	241.12	240.48	241.21	0.070075	0.91	3.37	11.72	0.18
Reach 1	690	PF 5	15.23	239.50	241.46	241.03	241.61	0.013711	0.51	7.59	12.68	0.08
Reach 1	667	PF 1	0.05	238.75	238.82	238.82	238.84	0.030924	1.29	0.04	0.69	0.92
Reach 1	667	PF 2	0.79	238.75	239.07	239.07	239.19	0.029765	2.73	0.29	1.23	0.99
Reach 1	667	PF 3	0.90	238.75	239.10	239.10	239.22	0.029521	2.84	0.32	1.24	0.99
Reach 1	667	PF 4	5.26	238.75	239.66	239.66	240.04	0.035757	4.93	1.07	1.41	1.00
Reach 1	667	PF 5	15.23	238.75	240.45	240.45	241.06	0.038570	6.31	2.41	1.96	1.00
Reach 1	645	PF 1	0.05	237.95	238.01	238.01	238.04	0.043936	1.32	0.04	0.83	1.05
Reach 1	645	PF 2	0.79	237.95	238.26	238.26	238.40	0.032974	2.95	0.27	0.98	0.99
Reach 1	645	PF 3	0.90	237.95	238.29	238.29	238.43	0.033059	3.06	0.29	1.00	0.99
Reach 1	645	PF 4	5.26	237.95	238.89	238.89	239.25	0.036110	4.80	1.10	1.53	1.00
Reach 1	645	PF 5	15.23	237.95	239.79	239.79	240.02	0.016511	4.30	4.29	8.25	0.66
Reach 1	619	PF 1	0.05	234.60	234.66	234.66	234.68	0.039535	1.32	0.04	0.77	1.01
Reach 1	619	PF 2	0.79	234.60	234.91	234.91	235.03	0.032369	2.87	0.27	1.10	1.01
Reach 1	619	PF 3	0.90	234.60	234.93	234.93	235.07	0.031041	2.95	0.31	1.11	0.99
Reach 1	619	PF 4	5.26	234.60	235.54	235.54	235.91	0.035975	4.86	1.08	1.48	1.00
Reach 1	619	PF 5	15.23	234.60	236.31	236.31	236.95	0.039674	6.39	2.38	1.88	1.00
Reach 1	605	PF 1	0.05	230.50	231.05	230.55	231.05	0.000087	0.02	1.30	16.26	0.01
Reach 1	605	PF 2	0.79	230.50	231.41	230.80	231.41	0.000023	0.02	7.37	17.00	0.00
Reach 1	605	PF 3	0.90	230.50	231.46	230.82	231.46	0.000021	0.02	8.16	17.26	0.00
Reach 1	605	PF 4	5.26	230.50	232.22	231.14	232.22	0.000028	0.03	21.82	18.61	0.00
Reach 1	605	PF 5	15.23	230.50	232.98	231.30	232.99	0.000047	0.06	36.61	20.06	0.01
Reach 1	584	PF 1	0.05	230.50	231.05	230.55	231.05	0.000098	0.02	1.23	16.03	0.01
Reach 1	584	PF 2	0.79	230.50	231.41	230.79	231.41	0.000024	0.02	7.19	16.70	0.00
Reach 1	584	PF 3	0.90	230.50	231.45	230.83	231.46	0.000022	0.02	7.94	16.74	0.00
Reach 1	584	PF 4	5.26	230.50	232.22	231.14	232.22	0.000005	0.01	45.97	35.82	0.00
Reach 1	584	PF 5	15.23	230.50	232.99	231.31	232.99	0.000009	0.03	73.70	36.49	0.00
Reach 1	563	PF 1	0.05	230.50	231.04	230.55	231.04	0.000047	0.01	1.66	26.42	0.00
Reach 1	563	PF 2	0.79	230.50	231.41	230.78	231.41	0.000008	0.01	11.40	27.08	0.00
Reach 1	563	PF 3	0.90	230.50	231.45	230.80	231.45	0.000008	0.01	12.64	27.14	0.00
Reach 1	563	PF 4	5.26	230.50	232.22	231.10	232.22	0.000010	0.02	33.90	28.54	0.00
Reach 1	563	PF 5	15.23	230.50	232.98	231.22	232.99	0.000016	0.03	56.32	29.94	0.00

HEC-RAS Plan: Plan 04 River: R3RB1 Reach: Reach 1 (Continued)

Reach	River Sta	Profile	Q Total (cfs)	Min Ch El (ft)	W.S. Elev (ft)	Crit W.S. (ft)	E.G. Elev (ft)	E.G. Slope (ft/ft)	Vel Chnl (ft/s)	Flow Area (sq ft)	Top Width (ft)	Froude # Chl
Reach 1	549	PF 1	0.05	230.50	231.04	230.55	231.04	0.001228	0.09	0.60	1.23	0.02
Reach 1	549	PF 2	0.79	230.50	231.40	230.77	231.41	0.057471	0.74	1.06	1.38	0.15
Reach 1	549	PF 3	0.90	230.50	231.44	230.79	231.45	0.064754	0.80	1.12	1.40	0.16
Reach 1	549	PF 4	5.26	230.50	232.11	231.40	232.21	0.314412	2.25	2.28	1.98	0.36
Reach 1	549	PF 5	15.23	230.50	232.15	232.15	232.91	2.395435	6.29	2.35	1.99	0.99
Reach 1	536	PF 1	0.05	230.50	231.03	230.59	231.03	0.001139	0.05	0.70	10.04	0.02
Reach 1	536	PF 2	0.79	230.50	231.08	230.91	231.10	0.013571	0.23	1.28	10.20	0.09
Reach 1	536	PF 3	0.90	230.50	231.09	230.93	231.11	0.015387	0.24	1.32	10.21	0.09
Reach 1	536	PF 4	5.26	230.50	231.22	231.22	231.35	0.029440	0.46	2.74	10.64	0.14
Reach 1	536	PF 5	15.23	230.50	231.50	231.50	231.71	0.018733	0.54	5.76	11.36	0.12
Reach 1	511	PF 1	0.05	230.62	231.01		231.01	0.000309	0.03	1.29	73.06	0.01
Reach 1	511	PF 2	0.79	230.62	231.07		231.07	0.000341	0.04	5.49	73.42	0.01
Reach 1	511	PF 3	0.90	230.62	231.08		231.08	0.000337	0.04	5.94	73.46	0.01
Reach 1	511	PF 4	5.26	230.62	231.20		231.20	0.000493	0.06	14.87	73.84	0.02
Reach 1	511	PF 5	15.23	230.62	231.35		231.35	0.000646	0.09	25.77	73.92	0.02
Reach 1	492	PF 1	0.05	230.50	231.01		231.01	0.000784	0.06	1.02	71.93	0.02
Reach 1	492	PF 2	0.79	230.50	231.06		231.06	0.000527	0.05	4.95	72.18	0.02
Reach 1	492	PF 3	0.90	230.50	231.07		231.07	0.000492	0.05	5.43	72.22	0.02
Reach 1	492	PF 4	5.26	230.50	231.19		231.19	0.000607	0.07	14.04	72.62	0.02
Reach 1	492	PF 5	15.23	230.50	231.33		231.34	0.000761	0.10	24.54	72.79	0.02
Reach 1	481	PF 1	0.05	230.59	230.98	230.66	230.98	0.008238	0.17	0.32	3.06	0.06
Reach 1	481	PF 2	0.79	230.59	231.05	230.96	231.05	0.002061	0.08	2.97	87.69	0.03
Reach 1	481	PF 3	0.90	230.59	231.06	230.98	231.06	0.001537	0.07	3.47	87.76	0.03
Reach 1	481	PF 4	5.26	230.59	231.17	231.06	231.18	0.001377	0.09	9.84	89.15	0.03
Reach 1	481	PF 5	15.23	230.59	231.31	231.13	231.33	0.001685	0.13	17.33	90.45	0.03
Reach 1	467	PF 1	0.05	230.50	230.55	230.55	230.58	2.725361	1.27	0.04	0.83	0.99
Reach 1	467	PF 2	0.79	230.50	230.80	230.80	230.93	2.179551	2.89	0.27	4.09	0.98
Reach 1	467	PF 3	0.90	230.50	230.83	230.83	230.97	2.271463	3.05	0.30	4.15	1.00
Reach 1	467	PF 4	5.26	230.50	231.08	231.08	231.13	0.041429	0.48	3.38	68.41	0.15
Reach 1	467	PF 5	15.23	230.50	231.18	231.17	231.26	0.021345	0.41	7.32	69.68	0.11
Reach 1	447	PF 1	0.05	229.21	230.03	229.27	230.03	0.000000	0.01	5.92	11.92	0.00
Reach 1	447	PF 2	0.79	229.21	230.12	229.41	230.12	0.000011	0.14	7.01	12.46	0.03
Reach 1	447	PF 3	0.90	229.21	230.13	229.43	230.13	0.000014	0.16	7.13	12.69	0.03
Reach 1	447	PF 4	5.26	229.21	230.33	229.69	230.34	0.000182	0.66	9.78	13.42	0.11
Reach 1	447	PF 5	15.23	229.21	231.23	229.92	231.24	0.000004	0.16	97.11	49.33	0.02
Reach 1	436	PF 1	0.05	228.72	230.03	228.57	230.03	0.000000	0.00	8.81	8.60	0.00
Reach 1	436	PF 2	0.79	228.72	230.12	228.73	230.12	0.000003	0.06	9.60	8.97	0.01
Reach 1	436	PF 3	0.90	228.72	230.13	228.75	230.13	0.000004	0.07	9.68	8.98	0.01
Reach 1	436	PF 4	5.26	228.72	230.33	229.05	230.33	0.000080	0.35	11.56	9.46	0.06
Reach 1	436	PF 5	15.23	228.72	231.23	229.36	231.23	0.000001	0.05	167.91	47.27	0.01
Reach 1	418	PF 1	0.05	229.50	230.03	229.55	230.03	0.000100	0.02	1.47	32.67	0.01
Reach 1	418	PF 2	0.79	229.50	230.12	229.80	230.12	0.000320	0.04	4.37	33.07	0.01
Reach 1	418	PF 3	0.90	229.50	230.13	229.83	230.13	0.000326	0.04	4.67	33.08	0.01
Reach 1	418	PF 4	5.26	229.50	230.33	230.09	230.33	0.000490	0.07	11.35	33.43	0.02
Reach 1	418	PF 5	15.23	229.50	231.23	230.19	231.23	0.000051	0.05	42.71	35.73	0.01
Reach 1	397	PF 1	0.05	229.63	230.03	229.70	230.03	0.000153	0.02	1.24	33.60	0.01
Reach 1	397	PF 2	0.79	229.63	230.11	229.95	230.11	0.000380	0.04	4.05	33.86	0.01
Reach 1	397	PF 3	0.90	229.63	230.12	229.97	230.12	0.000381	0.04	4.36	33.87	0.01
Reach 1	397	PF 4	5.26	229.63	230.32	230.09	230.32	0.000515	0.07	11.08	34.24	0.02
Reach 1	397	PF 5	15.23	229.63	231.23	230.19	231.23	0.000048	0.05	43.42	36.90	0.01
Reach 1	379	PF 1	0.05	229.50	230.02	229.59	230.02	0.000289	0.04	0.97	20.06	0.01
Reach 1	379	PF 2	0.79	229.50	230.10	229.68	230.10	0.001469	0.10	2.45	20.35	0.03
Reach 1	379	PF 3	0.90	229.50	230.10	229.68	230.11	0.001473	0.10	2.62	20.35	0.03
Reach 1	379	PF 4	5.26	229.50	230.29	230.12	230.30	0.001993	0.15	6.40	20.67	0.04
Reach 1	379	PF 5	15.23	229.50	231.23	230.26	231.23	0.000147	0.08	26.61	22.40	0.01
Reach 1	357	PF 1	0.05	229.50	230.02	229.55	230.02	0.000269	0.03	1.27	49.80	0.01
Reach 1	357	PF 2	0.79	229.50	230.08	229.80	230.08	0.000465	0.05	4.49	49.99	0.02
Reach 1	357	PF 3	0.90	229.50	230.09	229.83	230.09	0.000414	0.05	4.99	50.02	0.01
Reach 1	357	PF 4	5.26	229.50	230.28	230.07	230.29	0.000326	0.06	14.71	50.58	0.01
Reach 1	357	PF 5	15.23	229.50	231.23	230.14	231.23	0.000021	0.03	63.32	52.25	0.00
Reach 1	330	PF 1	0.05	229.74	230.00	229.79	230.00	0.007233	0.11	0.49	43.14	0.06
Reach 1	330	PF 2	0.79	229.74	230.06	230.02	230.06	0.002003	0.08	2.78	43.37	0.03
Reach 1	330	PF 3	0.90	229.74	230.06	230.02	230.07	0.001777	0.07	3.09	43.39	0.03
Reach 1	330	PF 4	5.26	229.74	230.27	230.07	230.27	0.000531	0.07	12.07	43.77	0.02

HEC-RAS Plan: Plan 04 River: R3RB1 Reach: Reach 1 (Continued)

Reach	River Sta	Profile	Q Total (cfs)	Min Ch El (ft)	W.S. Elev (ft)	Crit W.S. (ft)	E.G. Elev (ft)	E.G. Slope (ft/ft)	Vel Chnl (ft/s)	Flow Area (sq ft)	Top Width (ft)	Froude # Chl
Reach 1	330	PF 5	15.23	229.74	231.23	230.16	231.23	0.000029	0.04	54.91	45.70	0.01
Reach 1	315	PF 1	0.05	229.50	229.56	229.56	229.58	2.659357	1.28	0.04	0.83	1.00
Reach 1	315	PF 2	0.79	229.50	229.79	229.79	229.92	2.047425	2.84	0.28	1.11	1.00
Reach 1	315	PF 3	0.90	229.50	229.82	229.82	229.95	2.042235	2.94	0.31	1.13	1.00
Reach 1	315	PF 4	5.26	229.50	230.23		230.25	0.004214	0.20	5.30	20.96	0.05
Reach 1	315	PF 5	15.23	229.50	231.22		231.23	0.000144	0.08	27.52	23.89	0.01
Reach 1	310	PF 1	0.05	228.81	228.88	228.88	228.90	0.039724	1.26	0.04	0.87	1.00
Reach 1	310	PF 2	0.79	228.81	229.11	229.11	229.24	0.032642	2.92	0.27	1.02	1.00
Reach 1	310	PF 3	0.90	228.81	229.14	229.14	229.28	0.032861	3.04	0.30	1.03	1.00
Reach 1	310	PF 4	5.26	228.81	229.79	229.79	230.17	0.037627	4.95	1.06	1.36	0.99
Reach 1	310	PF 5	15.23	228.81	230.54	230.54	231.16	0.040257	6.35	2.40	1.93	1.01
Reach 1	293	PF 1	0.05	223.17	223.24	223.24	223.27	0.043315	1.40	0.04	0.73	1.08
Reach 1	293	PF 2	0.79	223.17	223.51	223.51	223.63	0.029269	2.74	0.29	1.18	0.98
Reach 1	293	PF 3	0.90	223.17	223.53	223.53	223.66	0.030929	2.91	0.31	1.19	1.00
Reach 1	293	PF 4	5.26	223.17	223.92	223.92	223.98	0.007605	2.15	2.80	8.67	0.51
Reach 1	293	PF 5	15.23	223.17	224.07	224.07	224.28	0.020786	3.82	4.18	9.72	0.88
Reach 1	261	PF 1	0.05	212.15	212.22	212.22	212.25	0.046404	1.37	0.04	0.76	1.06
Reach 1	261	PF 2	0.79	212.15	212.49	212.49	212.62	0.032059	2.92	0.27	0.98	0.98
Reach 1	261	PF 3	0.90	212.15	212.51	212.51	212.66	0.033003	3.06	0.29	1.00	0.99
Reach 1	261	PF 4	5.26	212.15	213.12	213.12	213.48	0.035599	4.82	1.09	1.52	1.00
Reach 1	261	PF 5	15.23	212.15	213.88	213.88	214.52	0.039555	6.41	2.38	1.88	1.01
Reach 1	239	PF 1	0.05	210.09	210.15	210.15	210.17	0.028803	1.15	0.05	0.85	0.86
Reach 1	239	PF 2	0.79	210.09	210.39	210.39	210.52	0.031568	2.90	0.27	1.03	1.00
Reach 1	239	PF 3	0.90	210.09	210.42	210.42	210.56	0.032273	3.04	0.30	1.05	1.01
Reach 1	239	PF 4	5.26	210.09	211.02	211.02	211.38	0.032234	4.75	1.11	1.58	1.00
Reach 1	239	PF 5	15.23	210.09	211.79	211.79	212.39	0.035841	6.24	2.44	2.01	1.00
Reach 1	216	PF 1	0.05	208.97	209.06	209.02	209.06	0.005029	0.61	0.09	1.12	0.38
Reach 1	216	PF 2	0.79	208.97	209.23	209.23	209.35	0.031038	2.78	0.28	1.17	0.99
Reach 1	216	PF 3	0.90	208.97	209.24	209.24	209.38	0.032920	2.96	0.30	1.18	1.02
Reach 1	216	PF 4	5.26	208.97	209.83	209.83	210.22	0.038000	5.01	1.05	1.35	1.00
Reach 1	216	PF 5	15.23	208.97	210.61	210.61	211.24	0.039264	6.36	2.40	1.89	0.99
Reach 1	199	PF 1	0.05	208.50	209.01	208.57	209.01	0.001961	0.09	0.62	18.34	0.03
Reach 1	199	PF 2	0.79	208.50	209.12	208.82	209.13	0.000864	0.08	2.81	18.85	0.02
Reach 1	199	PF 3	0.90	208.50	209.13	208.84	209.13	0.000970	0.08	2.92	18.86	0.02
Reach 1	199	PF 4	5.26	208.50	209.57	209.13	209.58	0.000257	0.07	11.52	19.83	0.01
Reach 1	199	PF 5	15.23	208.50	210.12	209.28	210.13	0.000237	0.09	22.57	20.68	0.01
Reach 1	180	PF 1	0.05	208.50	208.94		208.94	0.004746	0.14	0.37	1.26	0.05
Reach 1	180	PF 2	0.79	208.50	209.11		209.11	0.000839	0.07	2.96	23.13	0.02
Reach 1	180	PF 3	0.90	208.50	209.11		209.11	0.000980	0.08	3.04	23.13	0.02
Reach 1	180	PF 4	5.26	208.50	209.57		209.57	0.000164	0.06	13.90	24.02	0.01
Reach 1	180	PF 5	15.23	208.50	210.12		210.12	0.000152	0.08	27.36	25.16	0.01
Reach 1	159	PF 1	0.05	208.50	208.55	208.55	208.58	2.786806	1.28	0.04	0.82	1.00
Reach 1	159	PF 2	0.79	208.50	209.03	208.80	209.05	0.080814	0.51	0.91	15.45	0.19
Reach 1	159	PF 3	0.90	208.50	209.04	208.83	209.06	0.056939	0.44	1.04	15.47	0.16
Reach 1	159	PF 4	5.26	208.50	209.56		209.57	0.000433	0.08	9.51	16.72	0.02
Reach 1	159	PF 5	15.23	208.50	210.11		210.12	0.000381	0.11	19.84	25.26	0.02
Reach 1	150	PF 1	0.05	208.09	208.25		208.25	0.009270	0.60	0.09	0.77	0.31
Reach 1	150	PF 2	0.79	208.09	208.64		208.69	0.023234	1.80	0.44	1.01	0.48
Reach 1	150	PF 3	0.90	208.09	208.67		208.73	0.024814	1.90	0.47	1.03	0.49
Reach 1	150	PF 4	5.26	208.09	209.16	209.16	209.52	0.100868	4.82	1.09	1.54	1.01
Reach 1	150	PF 5	15.23	208.09	209.95	209.95	210.10	0.024697	3.34	5.25	17.62	0.60
Reach 1	128	PF 1	0.05	207.69	207.75	207.75	207.77	0.116422	0.99	0.05	1.78	1.00
Reach 1	128	PF 2	0.79	207.69	207.89	207.89	207.93	0.056338	1.76	0.47	5.42	0.87
Reach 1	128	PF 3	0.90	207.69	207.90	207.90	207.95	0.056443	1.80	0.52	5.94	0.88
Reach 1	128	PF 4	5.26	207.69	208.04	208.04	208.05	0.003111	0.59	5.42	22.82	0.22
Reach 1	128	PF 5	15.23	207.69	208.05	208.05	208.17	0.022781	1.65	5.65	22.86	0.61
Reach 1	97	PF 1	0.05	203.78	203.89	203.88	203.92	0.126622	1.35	0.04	0.82	1.07
Reach 1	97	PF 2	0.79	203.78	204.10	204.10	204.18	0.073391	2.29	0.35	2.09	0.99
Reach 1	97	PF 3	0.90	203.78	204.12	204.12	204.21	0.075733	2.32	0.39	2.37	1.01
Reach 1	97	PF 4	5.26	203.78	204.41	204.41	204.49	0.029715	2.63	2.29	13.00	0.73
Reach 1	97	PF 5	15.23	203.78	204.59	204.59	204.72	0.022304	2.92	5.25	17.54	0.67
Reach 1	58	PF 1	0.05	198.51	198.60	198.60	198.64	0.144321	1.56	0.03	0.61	1.15
Reach 1	58	PF 2	0.79	198.51	198.85	198.85	198.90	0.070784	1.89	0.42	3.83	0.94

HEC-RAS Plan: Plan 04 River: R3RB1 Reach: Reach 1 (Continued)

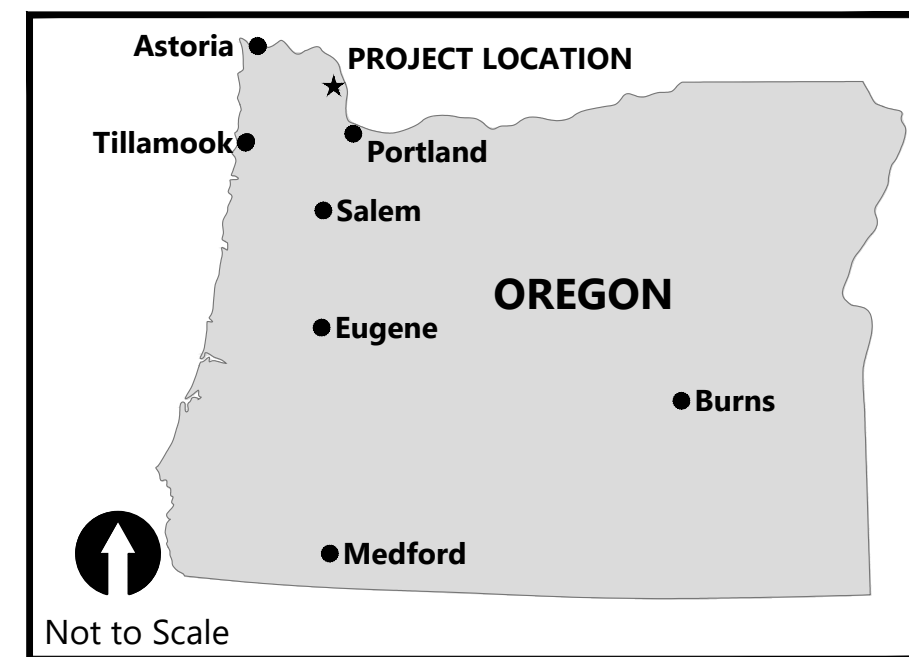
Reach	River Sta	Profile	Q Total (cfs)	Min Ch El (ft)	W.S. Elev (ft)	Crit W.S. (ft)	E.G. Elev (ft)	E.G. Slope (ft/ft)	Vel Chnl (ft/s)	Flow Area (sq ft)	Top Width (ft)	Froude # Chl
Reach 1	58	PF 3	0.90	198.51	198.86	198.86	198.92	0.067179	1.95	0.47	3.88	0.92
Reach 1	58	PF 4	5.26	198.51	199.10	199.10	199.27	0.050158	3.09	1.62	5.32	0.92
Reach 1	58	PF 5	15.23	198.51	199.45	199.45	199.71	0.034189	3.50	3.89	7.94	0.83
Reach 1	32	PF 1	0.05	192.51	192.60	192.60	192.62	0.086096	1.20	0.05	0.85	0.91
Reach 1	32	PF 2	0.79	192.51	192.82	192.82	192.91	0.068302	2.35	0.34	1.85	0.97
Reach 1	32	PF 3	0.90	192.51	192.84	192.84	192.93	0.072164	2.48	0.36	1.91	1.00
Reach 1	32	PF 4	5.26	192.51	193.21	193.21	193.40	0.054180	3.51	1.51	4.05	0.98
Reach 1	32	PF 5	15.23	192.51	193.60	193.60	193.91	0.037075	4.59	3.45	5.57	0.91
Reach 1	13	PF 1	0.05	185.71	185.77	185.77	185.80	0.212309	1.36	0.04	1.26	1.35
Reach 1	13	PF 2	0.79	185.71	185.96	185.96	186.04	0.063795	2.34	0.34	2.22	0.97
Reach 1	13	PF 3	0.90	185.71	185.98	185.98	186.06	0.057236	2.35	0.39	2.28	0.93
Reach 1	13	PF 4	5.26	185.71	186.34	186.34	186.55	0.045787	3.66	1.43	3.53	0.94
Reach 1	13	PF 5	15.23	185.71	186.77	186.77	187.14	0.034211	4.88	3.16	4.44	0.90

Appendix E
Grading Plan

PERMIT SUBMITTAL

WATTERS QUARRY PHASE II

KNIFE RIVER CORPORATION



DRAWING INDEX		
SHEET	DRAWING	TITLE
1	G1	TITLE SHEET
2	G2	GENERAL NOTES, LEGEND AND ABBREVIATIONS
3	EC1	EXISTING CONDITIONS
4	C1	SITE PLAN, SHEET INDEX, ACCESS ROUTES AND STAGING AREAS
5	C2	PLAN VIEW OF WETLAND PREPARATION (SHEET 1 OF 5)
6	C3	PLAN VIEW OF WETLAND PREPARATION (SHEET 2 OF 5)
7	C4	PLAN VIEW OF WETLAND PREPARATION (SHEET 3 OF 5)
8	C5	PLAN VIEW OF WETLAND PREPARATION (SHEET 4 OF 5)
9	C6	PLAN VIEW OF WETLAND PREPARATION (SHEET 5 OF 5)
10	C7	PROFILE ALONG CENTERLINE ALIGNMENT OF PROPOSED DRAINAGE CORRIDOR (SHEET 1 OF 2)
11	C8	PROFILE ALONG CENTERLINE ALIGNMENT OF PROPOSED DRAINAGE CORRIDOR (SHEET 2 OF 2)
12	C9	CROSS SECTIONS ALONG PROPOSED DRAINAGE CORRIDOR (SHEET 1 OF 4)
13	C10	CROSS SECTIONS ALONG PROPOSED DRAINAGE CORRIDOR (SHEET 4 OF 4)
14	C11	CROSS SECTIONS THROUGH WETLAND PREPARATION GRADING AREAS (SHEET 1 OF 2)
15	C12	CROSS SECTIONS THROUGH WETLAND PREPARATION GRADING AREAS (SHEET 1 OF 2)
16	C13	CROSS SECTIONS THROUGH WETLAND PREPARATION GRADING AREAS (SHEET 2 OF 2)
17	C14	PLANTING AREA DETAILS (SHEET 1 OF 2)
18	C15	PLANTING AREA DETAILS (SHEET 2 OF 2)
19	C16	PLANTING SCHEDULE
20	C17	PLANTING DETAILS
21	SC1	TEMPORARY EROSION AND SEDIMENTATION CONTROL PLAN
22	SC2	TEMPORARY EROSION AND SEDIMENTATION CONTROL NOTES AND DETAILS

K:\Projects\2114-Knife River Corporation-NWA\Watters Quarry Expansion\Construction Plans\2114-G-SERIES.dwg G1
Nov 30, 2023 12:51 pm chawett

PLAN INTENDED TO BE VIEWED
IN COLOR. ADJACENT BLOCK IS
"BLUE"
ONE INCH
AT FULL SIZE. IF NOT ONE
INCH SCALE ACCORDINGLY

PERMIT-NOT FOR CONSTRUCTION



REVISIONS				
REV	DATE	BY	APP'D	DESCRIPTION

DESIGNED BY: J. FOX
 DRAWN BY: D. HOLMER
 CHECKED BY: J. FOX
 APPROVED BY: G. SUMMERS
 SCALE: AS NOTED
 DATE: OCTOBER 2023

WATTERS QUARRY PHASE II PROJECT
KNIFE RIVER CORPORATION

TITLE SHEET

G1

SHEET # **1** OF **22**

GENERAL CONSTRUCTION NOTES

- CONTRACT DOCUMENTS REFER TO THESE DRAWINGS, THE PROJECT SPECIFICATIONS, THE BIDDING DOCUMENTS, AND THE CONSTRUCTION CONTRACT. ALL COMPONENTS OF THE CONTRACT DOCUMENTS SHALL FULLY APPLY TO THE WORK WHETHER SPECIFICALLY REFERENCED ON THE DRAWINGS OR NOT. ANY ITEMS NOT SPECIFICALLY REFERENCED IN THE NOTES ON THE DRAWINGS SHALL BE AS DESCRIBED IN THE SPECIFICATIONS.
- THE CONTRACTOR SHALL HAVE A COPY OF THE APPROVED CONTRACT AND PERMIT DOCUMENTS ON THE JOBSITE AT ALL TIMES.
- A PRE-CONSTRUCTION MEETING BETWEEN THE CONTRACTOR, OWNER, AND OWNER'S REPRESENTATIVE SHALL BE REQUIRED PRIOR TO ANY ON-SITE WORK. SEE THE SPECIFICATIONS FOR ADDITIONAL REQUIREMENTS
- THE CONTRACTOR SHALL VISIT THE JOB SITE PRIOR TO CONSTRUCTION AND SHALL BE RESPONSIBLE FOR VERIFYING FIELD CONDITIONS AND DIMENSIONS, AND CONFIRMING THAT THE WORK CAN BE ACCOMPLISHED AS SHOWN ON THESE CONTRACT DOCUMENTS. ANY DISCREPANCIES BETWEEN THE EXISTING FIELD CONDITIONS AND THE DRAWINGS OR ANY INCONSISTENCIES OR AMBIGUITIES BETWEEN THE DRAWINGS AND OTHER CONTRACT DOCUMENTS SHALL BE REPORTED IN WRITING TO THE OWNER PRIOR TO PROCEEDING WITH THE WORK. WORK DONE BY THE CONTRACTOR INVOLVING SUCH DISCREPANCIES WITHOUT A WRITTEN REPORT AND RESPONSE FROM THE OWNER SHALL BE DONE AT THE CONTRACTOR'S SOLE RISK AND EXPENSE.
- THE CONTRACTOR SHALL RECEIVE, IN WRITING, AUTHORIZATION TO PROCEED BEFORE STARTING WORK ON ANY ITEM NOT CLEARLY DEFINED OR IDENTIFIED BY THE CONTRACT DOCUMENTS.
- ALL WORK SHALL BE IN ACCORDANCE WITH EXISTING LABOR LAWS, SAFETY REQUIREMENTS, AND OTHER REGULATIONS, AS REQUIRED BY STATE OF OREGON, COLUMBIA COUNTY, AND THE FEDERAL GOVERNMENT. THE CONTRACTOR SHALL ASSUME SOLE AND COMPLETE RESPONSIBILITY FOR JOB SITE CONDITIONS DURING THE COURSE OF CONSTRUCTION, INCLUDING THE SAFETY OF ALL PERSONS AND PROPERTY. THIS REQUIREMENT SHALL APPLY CONTINUOUSLY AND IS NOT LIMITED TO NORMAL WORKING HOURS.
- THE CONTRACTOR SHALL BE SOLELY RESPONSIBLE FOR ALL CONSTRUCTION MEANS, METHODS, TECHNIQUES, SEQUENCES, AND PROCEDURES AND FOR COORDINATING ALL PORTIONS OF THE WORK UNDER THIS CONTRACT.
- THE DETAILS PROVIDED ON THE CONTRACT DOCUMENTS ARE INTENDED TO SHOW THE FINAL RESULT OF THE DESIGN. MINOR MODIFICATIONS MAY BE REQUIRED TO SUIT JOB SITE DIMENSIONS OR CONDITIONS. SUCH MODIFICATIONS SHALL BE CONSIDERED INCIDENTAL TO OTHER ITEMS INCLUDED IN THE BID SCHEDULE FOR THE WORK.
- THE CONTRACTOR SHALL MAKE ALL NECESSARY PROVISIONS TO PROTECT EXISTING STRUCTURES, IMPROVEMENTS, GROUNDWATER WELLS, SIGNS, FENCES, GATES, CURBS, ROADWAYS, DRAINAGE WAYS, CULVERTS, AND VEGETATION UNTIL SUCH ITEMS ARE TO BE DISTURBED OR REMOVED AS INDICATED ON THE CONTRACT DOCUMENTS. IF SUCH ITEMS ARE DAMAGED OR NEED TO BE REMOVED OR MODIFIED TO FACILITATE CONSTRUCTION, THE CONTRACTOR SHALL FIRST NOTIFY THE OWNER AND THEN REPLACE OR REPAIR THE ITEMS TO EQUAL OR BETTER CONDITION AT THE CONTRACTOR'S EXPENSE AND TO THE SATISFACTION OF THE OWNER.
- THE CONTRACTOR SHALL NOT DISTURB OR DESTROY ANY EXISTING SURVEY MONUMENT OR BENCHMARK. ANY SURVEY MONUMENT OR BENCHMARK DISTURBED OR DESTROYED BY THE CONTRACTOR SHALL BE REPLACED AS DIRECTED BY THE OWNER AT THE CONTRACTOR'S SOLE EXPENSE.
- REPRESENTATIONS OF TRUE NORTH SHALL NOT BE USED TO IDENTIFY OR ESTABLISH THE BEARING OF TRUE NORTH AT THE JOB SITE. THE CONTRACTOR IS ADVISED THAT NORTH ARROWS AND ORIENTATION OF THE PLAN VIEW SHEETS VARY TO ALLOW FOR LEFT-TO-RIGHT STATIONING AND STATIONING IN THE DIRECTION OF FLOW.
- WHERE A CONSTRUCTION DETAIL IS NOT SHOWN OR NOTED, THE DETAIL SHALL BE THE SAME AS FOR OTHER SIMILAR WORK.
- THE NOTES, DETAILS AND SPECIFICATIONS ON THE CONTRACT DOCUMENTS SHALL TAKE PRECEDENCE OVER THESE GENERAL NOTES.
- DIMENSION CALL-OUTS SHALL TAKE PRECEDENCE OVER SCALES SHOWN

ON THE CONTRACT DOCUMENTS.

- STATIONING, DISTANCES, AND LENGTHS SHOWN ON THE DRAWINGS ARE BASED ON HORIZONTAL MEASUREMENTS ALONG THE STREAM CENTERLINE.
- THE CONTRACTOR SHALL BE REQUIRED TO CONTROL ON-SITE STORM WATER RUNOFF BY USING TEMPORARY OR PERMANENT DRAINAGE EROSION/SILTATION CONTROL PROCEDURES. TEMPORARY EROSION AND SEDIMENT CONTROL (TESC) SHALL BE IN ACCORDANCE WITH THE REQUIREMENTS INCLUDED IN THE CONTRACT DOCUMENTS.
- THE CONTRACTOR SHALL MAINTAIN HAND DRAWN REDLINES, FIELD NOTES AND PHOTOGRAPHS ("FIELD DOCUMENTATION") OF ALL IMPROVEMENTS AS THE WORK PROGRESSES. THE CONTRACTOR SHALL ALSO TAKE PHOTOGRAPHS AND VIDEO TO DOCUMENT CONDITIONS PRIOR TO CONSTRUCTION. THE CONTRACTOR'S FIELD DOCUMENTATION SHALL BE MAINTAINED ON SITE AND SHALL BE AVAILABLE FOR REVIEW BY THE OWNER AT ALL TIMES. THE CONTRACTOR SHALL PROVIDE FIELD DOCUMENTATION TO THE OWNER FOR THE PREPARATION OF CERTIFIED RECORD DRAWINGS PRIOR TO PROJECT ACCEPTANCE.

STANDARD CIVIL NOTES

- ALL MATERIALS SHALL BE NEW AND UNDAMAGED, UNLESS OTHERWISE APPROVED BY THE CONTRACTING ORGANIZATION'S REPRESENTATIVE AND THE ENGINEER. THE SAME MANUFACTURER OF EACH ITEM SHALL BE USED THROUGHOUT THE WORK UNLESS OTHERWISE APPROVED BY THE OWNER AND THE ENGINEER.
 - ALL SITE WORK SHALL BE AS INDICATED ON THE CONTRACT DOCUMENTS. DO NOT EXCAVATE AND DISTURB BEYOND THE CLEARING LIMITS SHOWN ON THE CONTRACT DOCUMENTS UNLESS OTHERWISE APPROVED BY THE OWNER.
 - RUBBISH, DEBRIS, AND GARBAGE SHALL BE REMOVED FROM THE JOB SITE AND DISPOSED OF LEGALLY, AS REQUIRED BY THE PROJECT SPECIFICATIONS.
 - THE AREAS OF THE JOB SITE DISTURBED BY THE WORK SHALL BE GRADED SMOOTH AND PROTECTED AND/OR REVEGETATED AS SPECIFIED HEREIN.
- UTILITY NOTES
- THE LOCATIONS OF EXISTING UTILITIES SHOWN ON THESE DRAWINGS ARE APPROXIMATE.
 - UTILITY SERVICES HAVE NOT BEEN SHOWN ON THE PLAN AND PROFILE DRAWINGS. THE CONTRACTOR SHALL TAKE CARE NOT TO DISRUPT BURIED UTILITY SERVICES.
 - THE CONTRACTOR SHALL BE RESPONSIBLE FOR LOCATING ALL EXISTING UTILITIES PRIOR TO CONSTRUCTION. THE CONTRACTOR SHALL CONTACT THE UTILITY LOCATION REQUEST CENTER (ONE-CALL CENTER) AT 811 OR 1-800-332-2344 FOR UTILITY LOCATIONS NOT LESS THAN TWO (2) BUSINESS DAYS BEFORE THE SCHEDULED DATE FOR EARTHWORK OR TRENCHING THAT MAY IMPACT EXISTING UTILITIES.
 - ALL ABANDONED UTILITIES WHICH INTERFERE WITH THE EXECUTION OF THE WORK SHALL BE VERIFIED BY THE OWNER'S REPRESENTATIVE AND THE UTILITY OWNER PRIOR TO DISTURBANCE OR MODIFICATION. ONLY AFTER WRITTEN APPROVAL HAS BEEN RECEIVED FROM THE UTILITY OWNER BY THE OWNER, MAY THE CONTRACTOR TAKE ACTION.
 - THE SIZE, LOCATION, AND TYPE OF UNDERGROUND UTILITIES EXPOSED OR MODIFIED BY THE CONTRACTOR SHALL BE ACCURATELY NOTED AND PLACED ON THE CONTRACTOR'S AS-BUILT DRAWINGS. SEE GENERAL CONSTRUCTION NOTE 17 FOR ADDITIONAL REQUIREMENTS RELATED TO THE CONTRACTOR'S AS-BUILT DRAWINGS AND FIELD DOCUMENTATION.
 - THE CONTRACTOR SHALL ENSURE THAT OPERATION OF EXISTING DRAINAGE, POTABLE WATER, POWER, COMMUNICATIONS, AND OTHER UTILITY SYSTEMS IS NOT DISRUPTED DURING CONSTRUCTION WITHOUT PRIOR AUTHORIZATION OF THE UTILITY OWNER AND THE OWNER'S REPRESENTATIVE.





ABBREVIATIONS

'	FEET, MINUTES
"	INCHES, SECONDS
°	DEGREES
∅	DIAMETER
#	NUMBER
ASTM	AMERICAN SOCIETY FOR TESTING AND MATERIALS
BM	BENCHMARK
BMP	BEST MANAGEMENT PRACTICE
CFS	CUBIC FEET PER SECOND
CL	CENTERLINE
CMP	CORRUGATED METAL PIPE
CONC	CONCRETE
CPLG	COUPLING
CSBC	CRUSHED SURFACING BASE COURSE
CSTC	CRUSHED SURFACING TOP COURSE
CY	CUBIC YARDS
DIA	DIAMETER
DWG	DRAWING
E	EAST, EASTING
ELEV	ELEVATION
EX	EXISTING
FG	FINISHED GRADE
FL	FLOW LINE, FLANGE
FPS	FEET PER SECOND
GPM	GALLONS PER MINUTE
HPDE	HIGH-DENSITY POLYETHYLENE
HOR	HORIZONTAL
ID	INSIDE DIAMETER
IE	INVERT ELEVATION
L	LENGTH
LF	LINEAR FEET
MAX	MAXIMUM
MIN	MINIMUM
N	NORTH, NORTHING
NAD	NORTH AMERICAN DATUM
NAVD	NORTH AMERICAN VERTICAL DATUM
NTS	NOT TO SCALE
OC	ON CENTERS
OD	OUTSIDE DIAMETER
P	POWER
P.E.	PROFESSIONAL ENGINEER
PED	PEDESTAL
R, RAD	RADIUS
REINF	REINFORCED, REINFORCEMENT
ROW	RIGHT-OF-WAY
S	SLOPE, SOUTH
SS	SANITARY SEWER
ST	STORM
STA	STATION
SY	SQUARE YARD
TESC	TEMPORARY EROSION AND SEDIMENT CONTROL
T	TELEPHONE
TOW	TOP OF WALL
TYP	TYPICAL
W	WEST, WATER
W/	WITH
WSDOT	WASHINGTON DEPARTMENT OF TRANSPORTATION
WSEL	WATER SURFACE ELEVATION

K:\Projects\2114-Knife River Corporation-NW\Waters Quarry Expansion\Construction Plans\2114-G-SEBELS.dwg G2
Nov 30, 2023 12:51 pm chawett

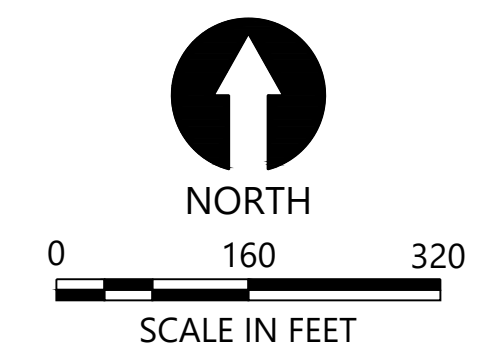
PLAN INTENDED TO BE VIEWED IN COLOR. ADJACENT BLOCK IS "BLUE"
ONE INCH AT FULL SIZE. IF NOT ONE INCH SCALE ACCORDINGLY

PERMIT-NOT FOR CONSTRUCTION

		<table border="1" style="width: 100%; border-collapse: collapse;"> <thead> <tr><th colspan="5">REVISIONS</th></tr> <tr><th>REV</th><th>DATE</th><th>BY</th><th>APP'D</th><th>DESCRIPTION</th></tr> </thead> <tbody> <tr><td> </td><td> </td><td> </td><td> </td><td> </td></tr> <tr><td> </td><td> </td><td> </td><td> </td><td> </td></tr> <tr><td> </td><td> </td><td> </td><td> </td><td> </td></tr> <tr><td> </td><td> </td><td> </td><td> </td><td> </td></tr> <tr><td> </td><td> </td><td> </td><td> </td><td> </td></tr> </tbody> </table>	REVISIONS					REV	DATE	BY	APP'D	DESCRIPTION																										DESIGNED BY: <u>J. FOX</u> DRAWN BY: <u>D. HOLMER</u> CHECKED BY: <u>J. FOX</u> APPROVED BY: <u>G. SUMMERS</u> SCALE: <u>AS NOTED</u> DATE: <u>OCTOBER 2023</u>	WATERS QUARRY PHASE II PROJECT KNIFE RIVER CORPORATION GENERAL NOTES, LEGEND AND ABBREVIATIONS	G2 SHEET # 2 OF 22
		REVISIONS																																						
REV	DATE	BY	APP'D	DESCRIPTION																																				
				PERMIT-NOT FOR CONSTRUCTION																																				



- LEGEND:
- EXISTING TOPOGRAPHY (5' INTERVAL)
 - PROJECT SITE
 - DELINEATED WETLAND AND STREAM BOUNDARIES
 - DRAINAGE BASIN BOUNDARY 21
 - DRAINAGE BASIN BOUNDARY 10
 - MINING BOUNDARY



- SOURCES:
1. AERIAL ©2020 MICROSOFT CORPORATION ©2020 DIGITALGLOBE ©CNES (2020) DISTRIBUTION AIRBUS DS
 2. TOPOGRAPHIC SURVEY PROVIDED BY GEOTERRA DATED FEBRUARY 10, 2018.

HORIZONTAL DATUM: OREGON STATE PLANE NORTH ZONE, NAD83, INTERNATIONAL FEET
 VERTICAL DATUM: NORTH AMERICAN VERTICAL DATUM OF 1988 (NAVD88)

PERMIT-NOT FOR CONSTRUCTION

PLAN INTENDED TO BE VIEWED IN COLOR. ADJACENT BLOCK IS "BLUE" INCH SCALE ACCORDINGLY

K:\Projects\2114-Knife River Corporation-NWA\Watters Quarry Expansion\Construction Plans\2114-E-SERIES.dwg EC1

Nov 30, 2023 12:51 pm chawett



REVISIONS				
REV	DATE	BY	APP'D	DESCRIPTION

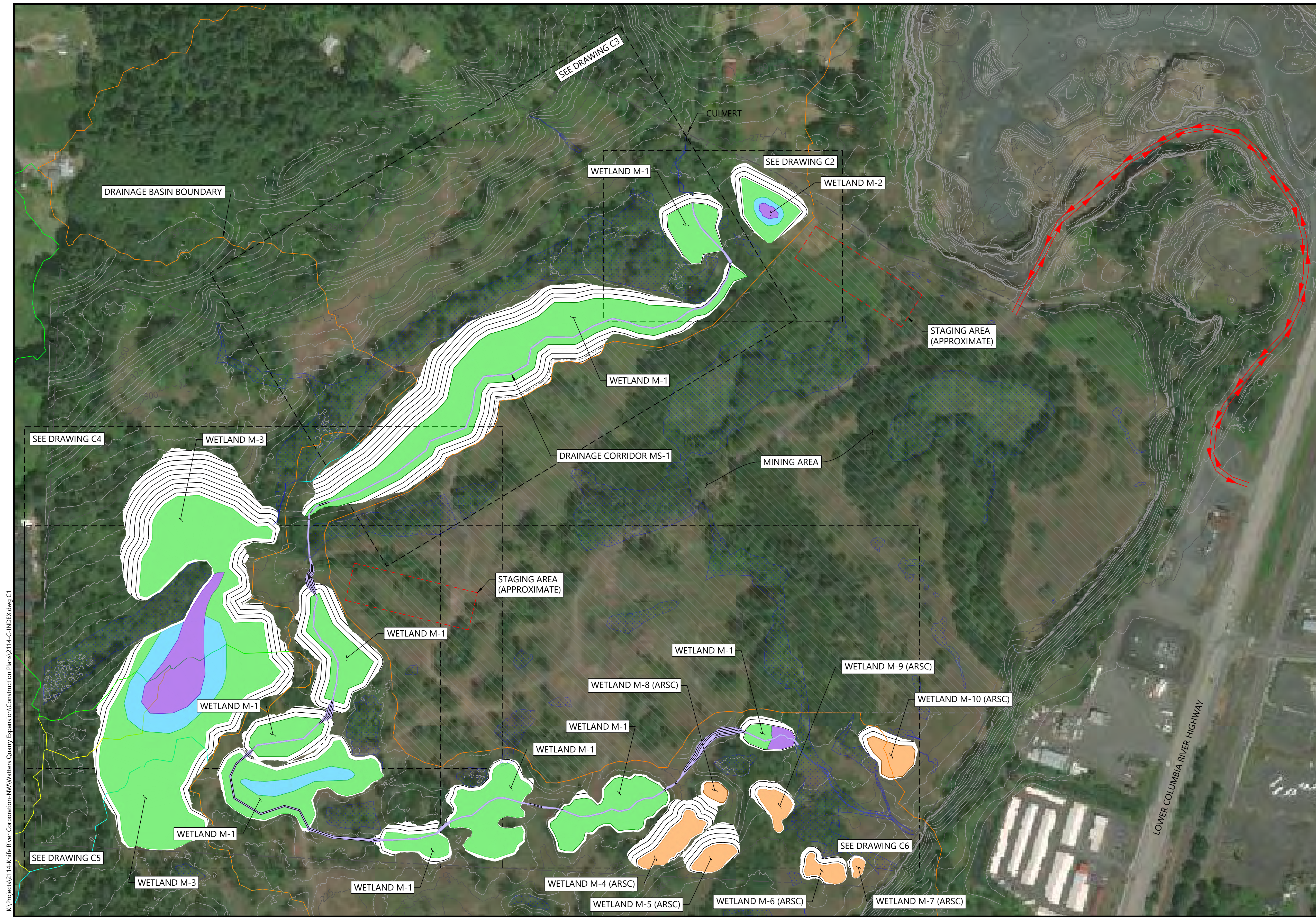
DESIGNED BY: J. FOX
 DRAWN BY: D. HOLMER
 CHECKED BY: J. FOX
 APPROVED BY: G. SUMMERS
 SCALE: AS NOTED
 DATE: OCTOBER 2023

WATERS QUARRY PHASE II PROJECT
KNIFE RIVER CORPORATION

EXISTING CONDITIONS

EC1

SHEET # **3** OF **22**



- LEGEND:
- EXISTING TOPOGRAPHY (5' INTERVAL)
 - PRELIMINARY QUARRY EXCAVATION CONTOURS (5' INTERVAL)
 - PROJECT SITE
 - DELINEATED WETLAND AND STREAM BOUNDARIES
 - MINING BOUNDARY
 - ACCESS ROUTE AND DIRECTION
 - STAGING AREA

- COWARDIN CLASSIFICATIONS:
- PERENNIAL STREAM (R3RB1)
 - PEM
 - PFO
 - PSS
 - ARSC

- POST-CONSTRUCTION DRAINAGE BASINS:
- BASIN 10
 - BASIN 18
 - CENTRAL BASIN
 - OTHER



0 160 320
SCALE IN FEET

SOURCE: AERIAL ©2020 MICROSOFT CORPORATION
©2020 DIGITALGLOBE ©CNES (2020) DISTRIBUTION AIRBUS DS

HORIZONTAL DATUM: OREGON STATE PLANE NORTH ZONE, NAD83, INTERNATIONAL FEET

VERTICAL DATUM: NORTH AMERICAN VERTICAL DATUM OF 1988 (NAVD88)

PERMIT-NOT FOR CONSTRUCTION

PLAN INTENDED TO BE VIEWED IN COLOR. ADJACENT BLOCK IS "BLUE" INCH SCALE ACCORDINGLY

K:\Projects\2114-Knife River Corporation-NWA\Watters Quarry Expansion\Construction Plans\2114-C-INDEX.dwg C1

Nov 30, 2023 12:52pm chawett



REVISIONS				
REV	DATE	BY	APP'D	DESCRIPTION

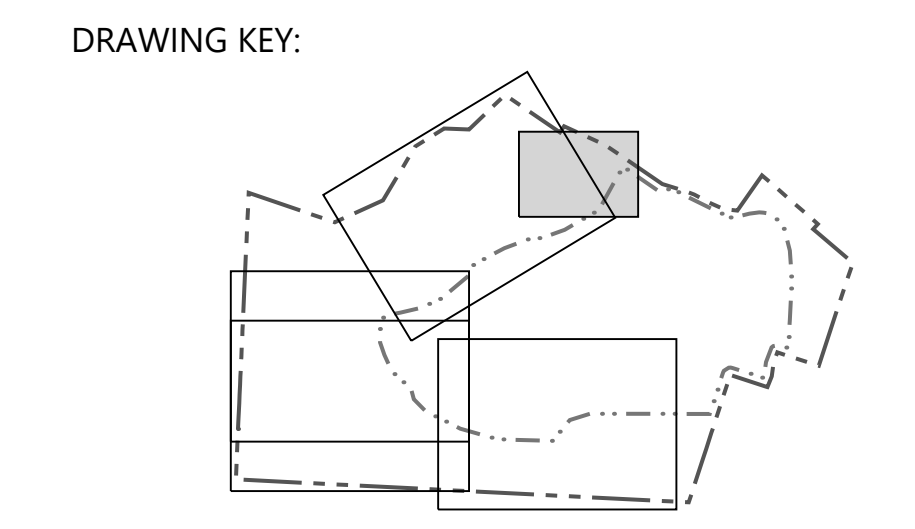
DESIGNED BY: J. FOX
 DRAWN BY: D. HOLMER
 CHECKED BY: J. FOX
 APPROVED BY: G. SUMMERS
 SCALE: AS NOTED
 DATE: OCTOBER 2023

WATERS QUARRY PHASE II PROJECT
KNIFE RIVER CORPORATION

SITE PLAN, SHEET INDEX, ACCESS ROUTES
AND STAGING AREAS

C1

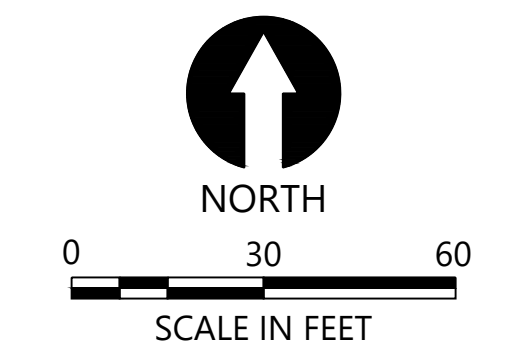
SHEET # 4 OF 22



- LEGEND:**
- EXISTING TOPOGRAPHY (2' INTERVAL)
 - PRELIMINARY QUARRY EXCAVATION CONTOURS (2' INTERVAL)
 - PROJECT SITE
 - DELINEATED WETLAND AND STREAM BOUNDARIES
 - MINING BOUNDARY
 - LARGE WOODY DEBRIS (SEE NOTE)
 - DRAINAGE BASIN BOUNDARIES
 - CROSS SECTION LOCATION ALONG R3RB1 (SEE DRAWINGS C9, C10, AND C11)

- COWARDIN CLASSIFICATIONS:**
- PERENNIAL STREAM (R3RB1)
 - PEM
 - PFO
 - PSS
 - ARSC

- NOTES:**
1. LARGE WOODY DEBRIS, MINIMUM 5-INCHES DIAMETER AND 6- FEET IN LENGTH, PLACED MINIMUM 20 PIECES EVERY 325 LINEAR FEET OF PERENNIAL STREAM CHANNEL AT THE DIRECTION OF THE ENGINEER. MINIMUM 30% OF PLACED WOODY DEBRIS SHALL HAVE INTACT ROOTWAD.
 2. PLACE SOILS, APPROXIMATE 6-INCH DEPTH, IN ALL PEM WETLANDS.
 3. PLACE SOILS, APPROXIMATE 36-INCH DEPTH, IN ALL PFO AND PSS WETLANDS.
 4. NO DISTURBANCE SHALL BE ALLOWED IN EXISTING DELINEATED WETLANDS. PLACE TREE PROTECTION FENCING ALONG EXISTING WETLAND BOUNDARIES THAT ARE WITHIN 30 FEET OF WORK AREAS.



SOURCE: AERIAL ©2020 MICROSOFT CORPORATION ©2020 DIGITALGLOBE ©CNES (2020) DISTRIBUTION AIRBUS DS

HORIZONTAL DATUM: OREGON STATE PLANE NORTH ZONE, NAD83, INTERNATIONAL FEET

VERTICAL DATUM: NORTH AMERICAN VERTICAL DATUM OF 1988 (NAVD88)

PERMIT-NOT FOR CONSTRUCTION

K:\Projects\2114-Knife River Corporation-NWA\Waters Quarry Expansion\Construction Plans\2114-C-SERIES.dwg C2
Nov 30, 2023 12:53pm chawett



REVISIONS				
REV	DATE	BY	APP'D	DESCRIPTION

DESIGNED BY: J. FOX

DRAWN BY: D. HOLMER

CHECKED BY: J. FOX

APPROVED BY: G. SUMMERS

SCALE: AS NOTED

DATE: OCTOBER 2023

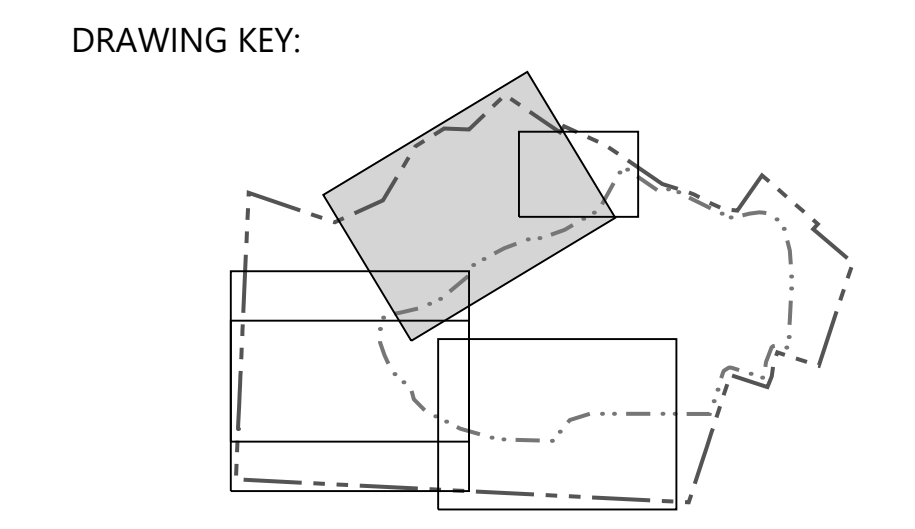
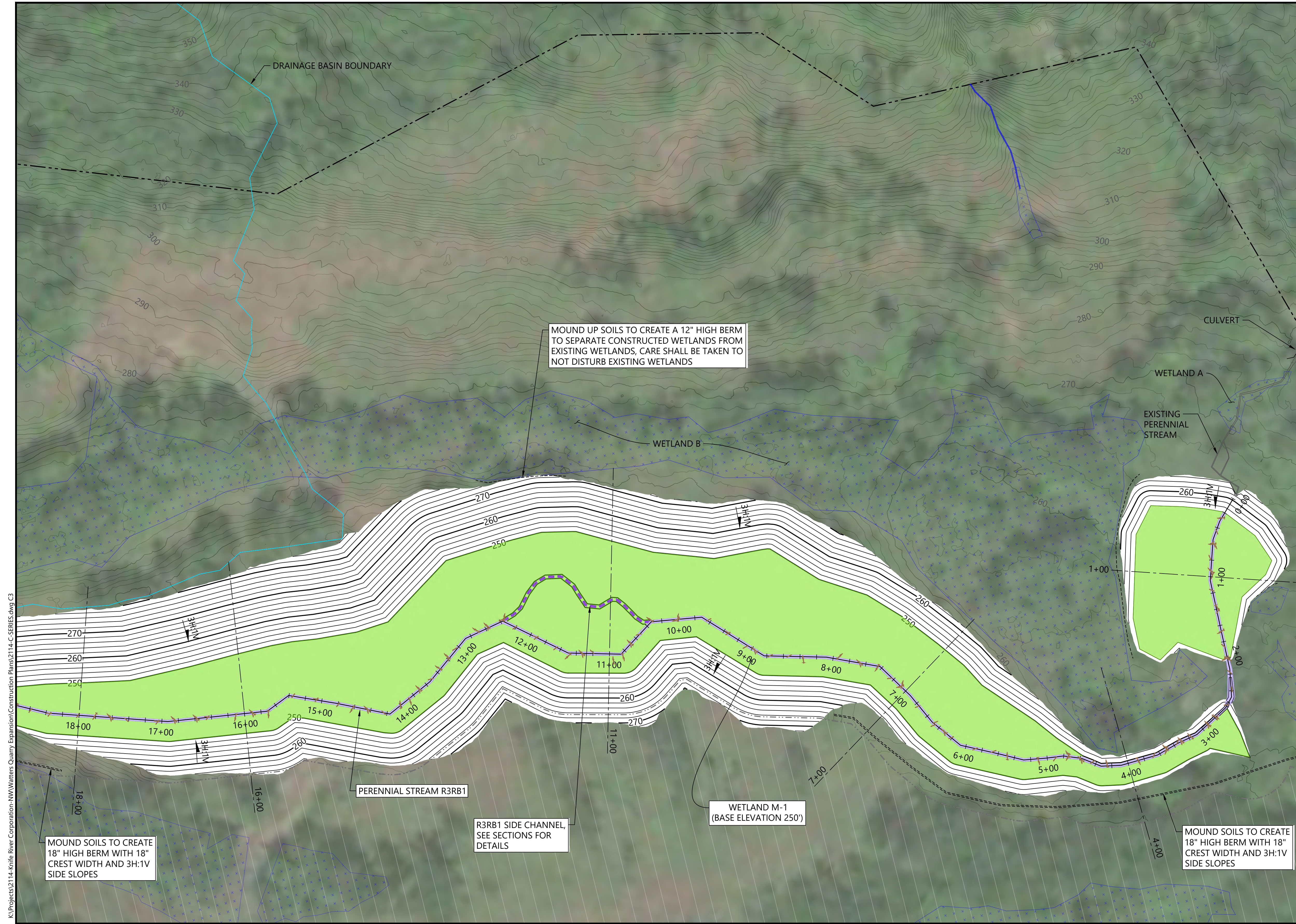
WATERS QUARRY PHASE II PROJECT
KNIFE RIVER CORPORATION

PLAN VIEW OF WETLAND PREPARATION (SHEET 1 OF 5)

C2

SHEET # **5** OF **22**

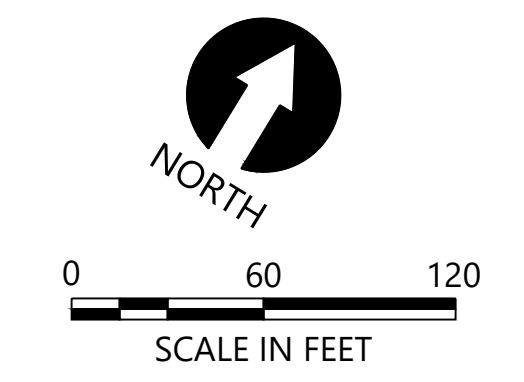
PLAN INTENDED TO BE VIEWED IN COLOR. ADJACENT BLOCK IS "BLUE" INCH SCALE ACCORDINGLY



- LEGEND:**
- EXISTING TOPOGRAPHY (2' INTERVAL)
 - PRELIMINARY QUARRY EXCAVATION CONTOURS (2' INTERVAL)
 - PROJECT SITE
 - DELINEATED WETLAND AND STREAM BOUNDARIES
 - MINING BOUNDARY
 - LARGE WOODY DEBRIS (SEE NOTE)
 - DRAINAGE BASIN BOUNDARIES
 - 1+00 CROSS SECTION LOCATION ALONG R3RB1 (SEE DRAWINGS C9, C10, AND C11)

- COWARDIN CLASSIFICATIONS:**
- PERENNIAL STREAM (R3RB1)
 - PEM
 - PFO
 - PSS
 - ARSC

- NOTES:**
1. LARGE WOODY DEBRIS, MINIMUM 5-INCHES DIAMETER AND 6- FEET IN LENGTH, PLACED MINIMUM 20 PIECES EVERY 325 LINEAR FEET OF PERENNIAL STREAM CHANNEL AT THE DIRECTION OF THE ENGINEER. MINIMUM 30% OF PLACED WOODY DEBRIS SHALL HAVE INTACT ROOTWAD.
 2. PLACE SOILS, APPROXIMATE 6-INCH DEPTH, IN ALL PEM WETLANDS.
 3. PLACE SOILS, APPROXIMATE 36-INCH DEPTH, IN ALL PFO AND PSS WETLANDS.
 4. NO DISTURBANCE SHALL BE ALLOWED IN EXISTING DELINEATED WETLANDS. PLACE TREE PROTECTION FENCING ALONG EXISTING WETLAND BOUNDARIES THAT ARE WITHIN 30 FEET OF WORK AREAS.



SOURCE: AERIAL ©2020 MICROSOFT CORPORATION ©2020 DIGITALGLOBE ©CNES (2020) DISTRIBUTION AIRBUS DS

HORIZONTAL DATUM: OREGON STATE PLANE NORTH ZONE, NAD83, INTERNATIONAL FEET

VERTICAL DATUM: NORTH AMERICAN VERTICAL DATUM OF 1988 (NAVD88)

PERMIT-NOT FOR CONSTRUCTION

K:\Projects\2114-Knife River Corporation-NW\Watters Quarry Expansion\Construction Plans\2114-C-SERIES.dwg C3
Nov 30, 2023 12:54pm chewet

MOUND SOILS TO CREATE 18" HIGH BERM WITH 18" CREST WIDTH AND 3H:1V SIDE SLOPES

MOUND UP SOILS TO CREATE A 12" HIGH BERM TO SEPARATE CONSTRUCTED WETLANDS FROM EXISTING WETLANDS, CARE SHALL BE TAKEN TO NOT DISTURB EXISTING WETLANDS

PERENNIAL STREAM R3RB1

R3RB1 SIDE CHANNEL, SEE SECTIONS FOR DETAILS

WETLAND M-1 (BASE ELEVATION 250')

MOUND SOILS TO CREATE 18" HIGH BERM WITH 18" CREST WIDTH AND 3H:1V SIDE SLOPES



REVISIONS				
REV	DATE	BY	APP'D	DESCRIPTION

DESIGNED BY: J. FOX
 DRAWN BY: D. HOLMER
 CHECKED BY: J. FOX
 APPROVED BY: G. SUMMERS
 SCALE: AS NOTED
 DATE: OCTOBER 2023

WATERS QUARRY PHASE II PROJECT
KNIFE RIVER CORPORATION

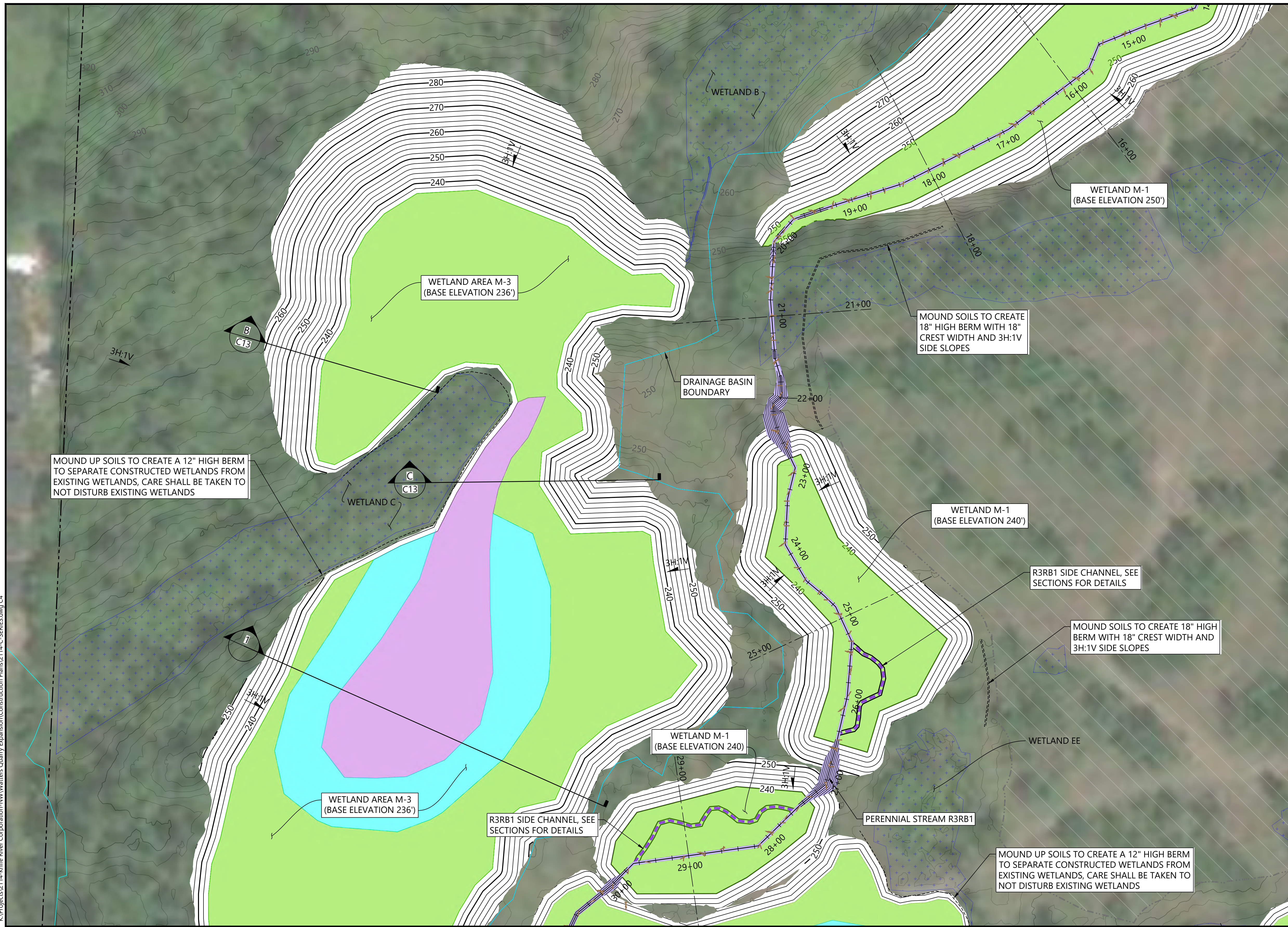
PLAN VIEW OF WETLAND PREPARATION (SHEET 2 OF 5)

C3

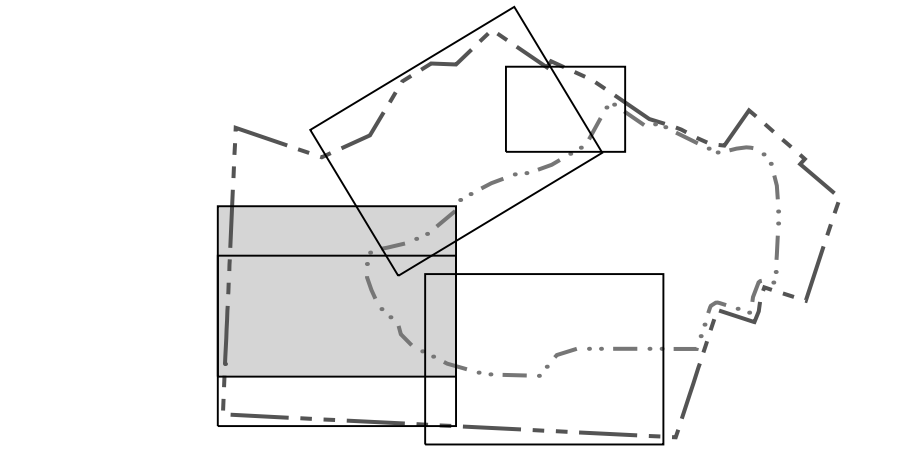
SHEET # **6** OF **22**

PLAN INTENDED TO BE VIEWED IN COLOR. ADJACENT BLOCK IS "BLUE" INCH SCALE ACCORDINGLY

K:\Projects\2114-Knife River Corporation-NWA\Waters Quarry Expansion\Construction Plans\2114-C-SERIES.dwg C4
Nov 30, 2023 12:54pm chawett



DRAWING KEY:



LEGEND:

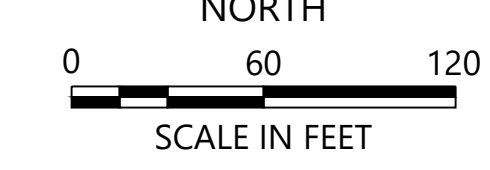
- EXISTING TOPOGRAPHY (2' INTERVAL)
- PRELIMINARY QUARRY EXCAVATION CONTOURS (2' INTERVAL)
- PROJECT SITE
- DELINEATED WETLAND AND STREAM BOUNDARIES
- MINING BOUNDARY
- LARGE WOODY DEBRIS (SEE NOTE)
- DRAINAGE BASIN BOUNDARIES
- 1+00 CROSS SECTION LOCATION ALONG R3RB1 (SEE DRAWINGS C9, C10, AND C11)

COWARDIN CLASSIFICATIONS:

- PERENNIAL STREAM (R3RB1)
- PEM
- PFO
- PSS
- ARSC

NOTES:

- LARGE WOODY DEBRIS, MINIMUM 5-INCHES DIAMETER AND 6- FEET IN LENGTH, PLACED MINIMUM 20 PIECES EVERY 325 LINEAR FEET OF PERENNIAL STREAM CHANNEL AT THE DIRECTION OF THE ENGINEER. MINIMUM 30% OF PLACED WOODY DEBRIS SHALL HAVE INTACT ROOTWAD.
- PLACE SOILS, APPROXIMATE 6-INCH DEPTH, IN ALL PEM WETLANDS.
- PLACE SOILS, APPROXIMATE 36-INCH DEPTH, IN ALL PFO AND PSS WETLANDS.
- NO DISTURBANCE SHALL BE ALLOWED IN EXISTING DELINEATED WETLANDS. PLACE TREE PROTECTION FENCING ALONG EXISTING WETLAND BOUNDARIES THAT ARE WITHIN 30 FEET OF WORK AREAS.



SOURCE: AERIAL ©2020 MICROSOFT CORPORATION ©2020 DIGITALGLOBE ©CNES (2020) DISTRIBUTION AIRBUS DS

HORIZONTAL DATUM: OREGON STATE PLANE NORTH ZONE, NAD83, INTERNATIONAL FEET

VERTICAL DATUM: NORTH AMERICAN VERTICAL DATUM OF 1988 (NAVD88)

PERMIT-NOT FOR CONSTRUCTION

PLAN INTENDED TO BE VIEWED IN COLOR. ADJACENT BLOCK IS "BLUE" INCH SCALE ACCORDINGLY



REVISIONS				
REV	DATE	BY	APP'D	DESCRIPTION

DESIGNED BY: J. FOX
 DRAWN BY: D. HOLMER
 CHECKED BY: J. FOX
 APPROVED BY: G. SUMMERS
 SCALE: AS NOTED
 DATE: OCTOBER 2023

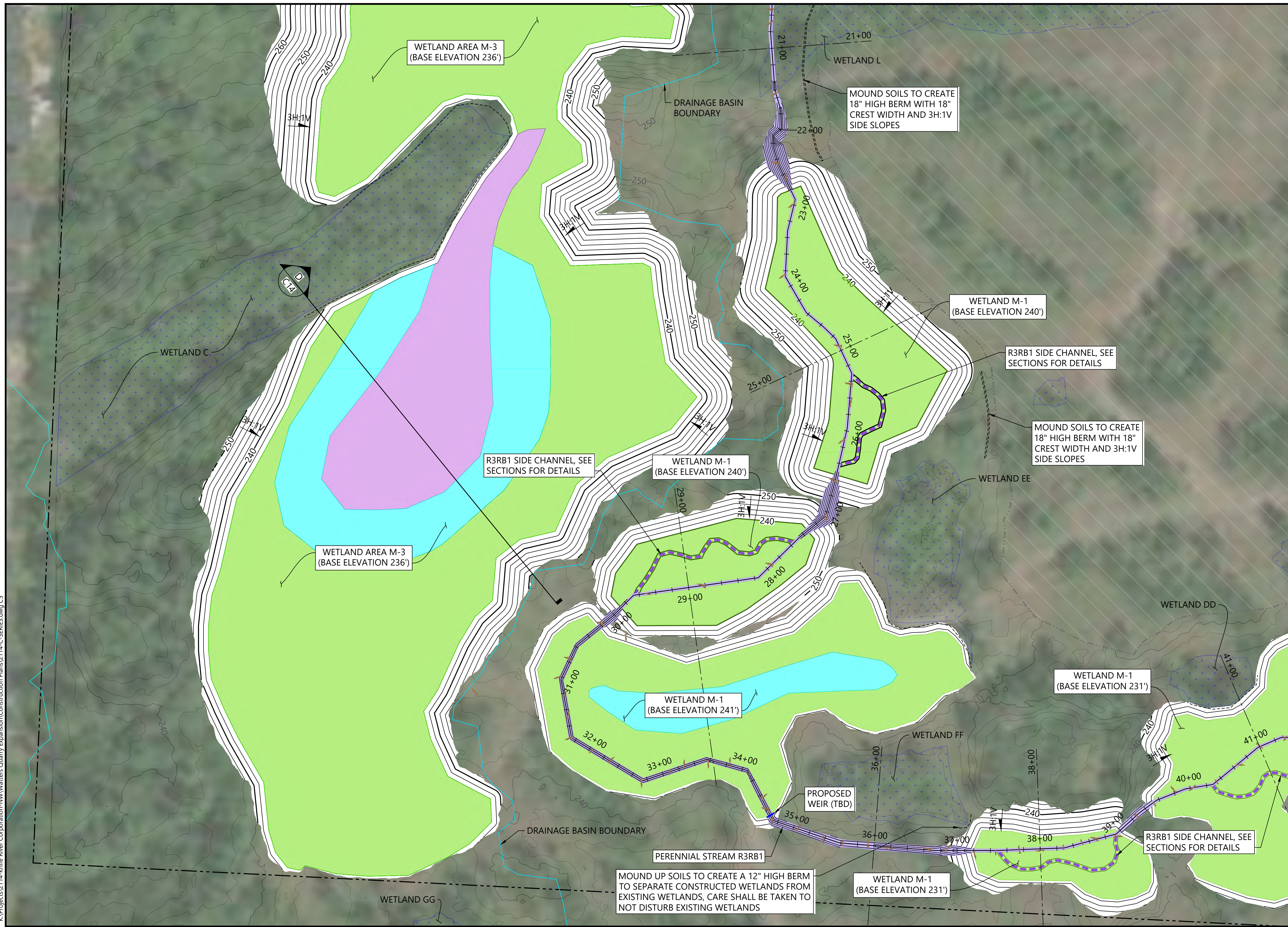
WATERS QUARRY PHASE II PROJECT
KNIFE RIVER CORPORATION

PLAN VIEW OF WETLAND PREPARATION (SHEET 3 OF 5)

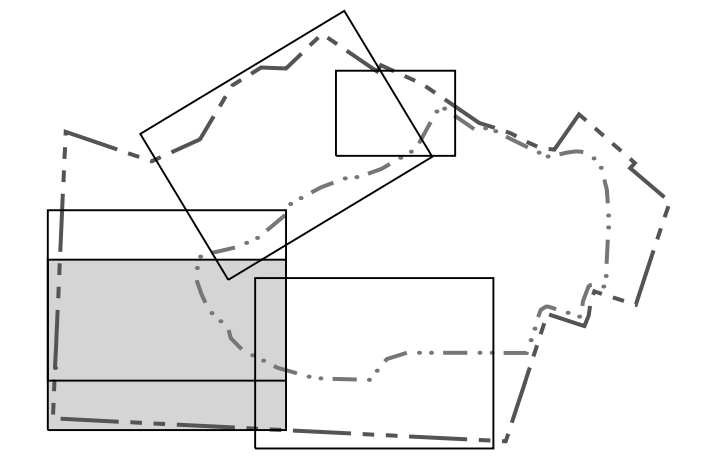
C4

SHEET # 7 OF 22

K:\Projects\2114-Knife River Corporation-NWA\Watters Quarry Expansion\Construction Plans\2114-C-SERIES.dwg C5
Nov 30, 2023 12:55pm chawett



DRAWING KEY:



LEGEND:

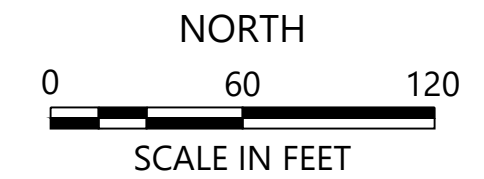
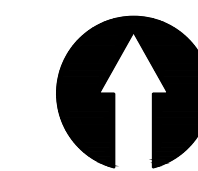
- EXISTING TOPOGRAPHY (2' INTERVAL)
- PRELIMINARY QUARRY EXCAVATION CONTOURS (2' INTERVAL)
- PROJECT SITE
- DELINEATED WETLAND AND STREAM BOUNDARIES
- MINING BOUNDARY
- LARGE WOODY DEBRIS (SEE NOTE)
- DRAINAGE BASIN BOUNDARIES
- 1+00 CROSS SECTION LOCATION ALONG R3RB1 (SEE DRAWINGS C9, C10, AND C11)

COWARDIN CLASSIFICATIONS:

- PERENNIAL STREAM (R3RB1)
- PEM
- PFO
- PSS
- ARSC

NOTES:

1. LARGE WOODY DEBRIS, MINIMUM 5-INCHES DIAMETER AND 6- FEET IN LENGTH, PLACED MINIMUM 20 PIECES EVERY 325 LINEAR FEET OF PERENNIAL STREAM CHANNEL AT THE DIRECTION OF THE ENGINEER. MINIMUM 30% OF PLACED WOODY DEBRIS SHALL HAVE INTACT ROOTWAD.
2. PLACE SOILS, APPROXIMATE 6-INCH DEPTH, IN ALL PEM WETLANDS.
3. PLACE SOILS, APPROXIMATE 36-INCH DEPTH, IN ALL PFO AND PSS WETLANDS.
4. NO DISTURBANCE SHALL BE ALLOWED IN EXISTING DELINEATED WETLANDS. PLACE TREE PROTECTION FENCING ALONG EXISTING WETLAND BOUNDARIES THAT ARE WITHIN 30 FEET OF WORK AREAS.



SOURCE: AERIAL ©2020 MICROSOFT CORPORATION ©2020 DIGITALGLOBE ©CNES (2020) DISTRIBUTION AIRBUS DS

HORIZONTAL DATUM: OREGON STATE PLANE NORTH ZONE, NAD83, INTERNATIONAL FEET

VERTICAL DATUM: NORTH AMERICAN VERTICAL DATUM OF 1988 (NAVD88)

PERMIT-NOT FOR CONSTRUCTION

PLAN INTENDED TO BE VIEWED IN COLOR. ADJACENT BLOCK IS "BLUE" INCH SCALE ACCORDINGLY



REVISIONS				
REV	DATE	BY	APP'D	DESCRIPTION

DESIGNED BY: J. FOX
 DRAWN BY: D. HOLMER
 CHECKED BY: J. FOX
 APPROVED BY: G. SUMMERS
 SCALE: AS NOTED
 DATE: OCTOBER 2023

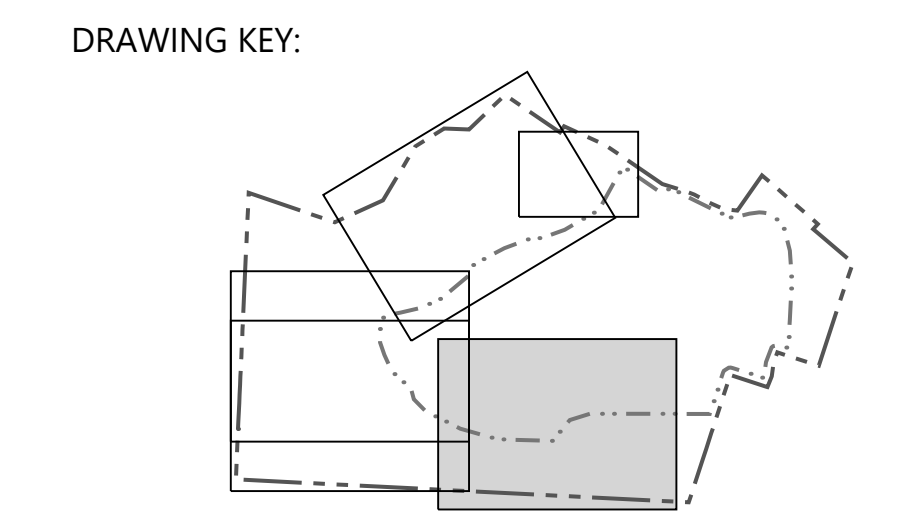
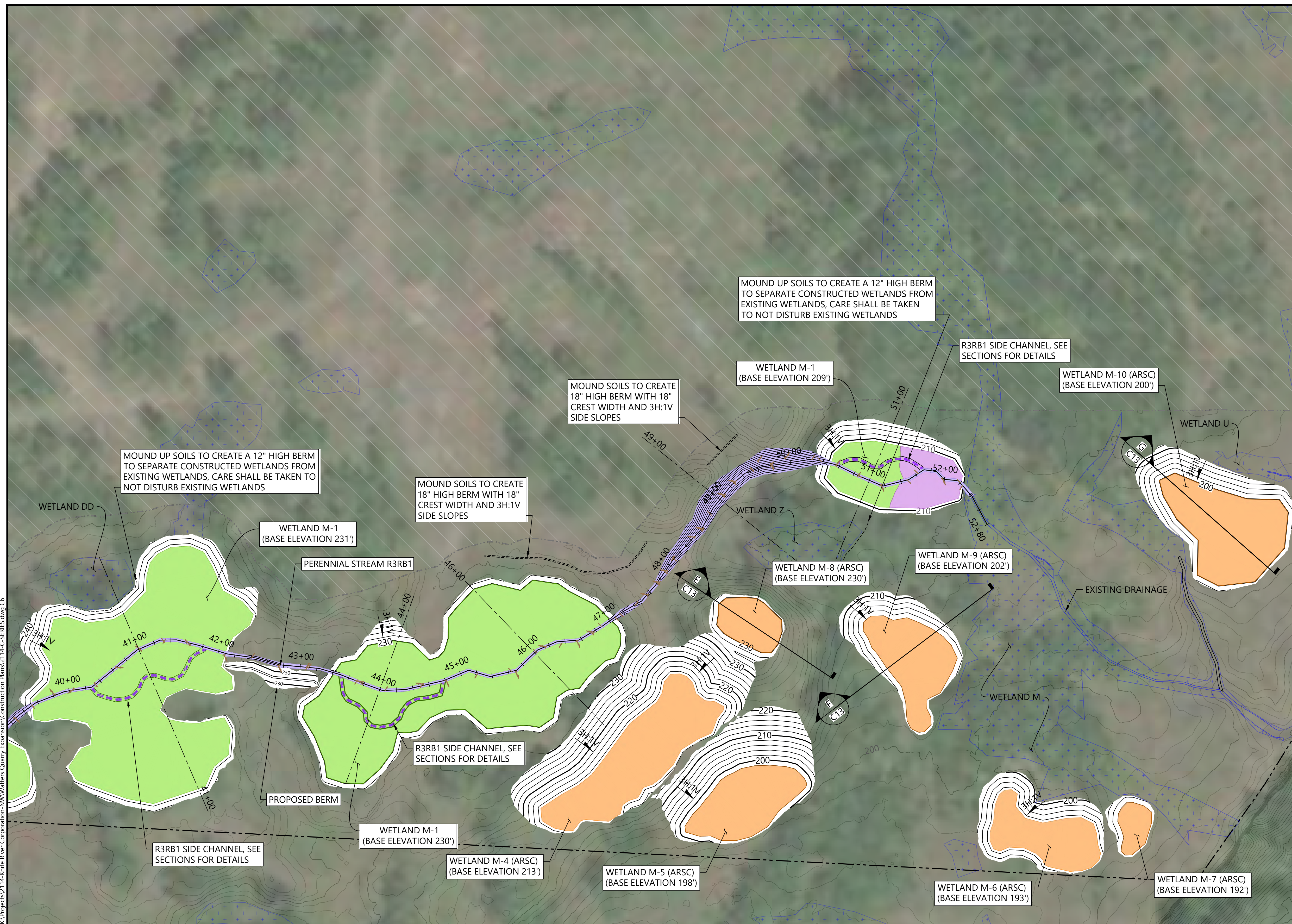
WATERS QUARRY PHASE II PROJECT
KNIFE RIVER CORPORATION

PLAN VIEW OF WETLAND PREPARATION (SHEET 4 OF 5)

C5

SHEET # 8 OF 22

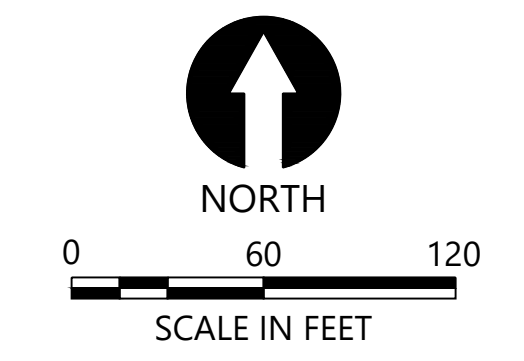
K:\Projects\2114-Knife River Corporation-NWA\Watters Quarry Expansion\Construction Plans\2114-C-SERIES.dwg C6
Nov 30, 2023 12:56pm chawett



- LEGEND:**
- EXISTING TOPOGRAPHY (2' INTERVAL)
 - PRELIMINARY QUARRY EXCAVATION CONTOURS (2' INTERVAL)
 - PROJECT SITE
 - DELINEATED WETLAND AND STREAM BOUNDARIES
 - MINING BOUNDARY
 - LARGE WOODY DEBRIS (SEE NOTE)
 - DRAINAGE BASIN BOUNDARIES
 - CROSS SECTION LOCATION ALONG R3RB1 (SEE DRAWINGS C9, C10, AND C11)

- COWARDIN CLASSIFICATIONS:**
- PERENNIAL STREAM (R3RB1)
 - PEM
 - PFO
 - PSS
 - ARSC

- NOTES:**
1. LARGE WOODY DEBRIS, MINIMUM 5-INCHES DIAMETER AND 6- FEET IN LENGTH, PLACED MINIMUM 20 PIECES EVERY 325 LINEAR FEET OF PERENNIAL STREAM CHANNEL AT THE DIRECTION OF THE ENGINEER. MINIMUM 30% OF PLACED WOODY DEBRIS SHALL HAVE INTACT ROOTWAD.
 2. PLACE SOILS, APPROXIMATE 6-INCH DEPTH, IN ALL PEM WETLANDS.
 3. PLACE SOILS, APPROXIMATE 36-INCH DEPTH, IN ALL PFO AND PSS WETLANDS.
 4. NO DISTURBANCE SHALL BE ALLOWED IN EXISTING DELINEATED WETLANDS. PLACE TREE PROTECTION FENCING ALONG EXISTING WETLAND BOUNDARIES THAT ARE WITHIN 30 FEET OF WORK AREAS.



SOURCE: AERIAL ©2020 MICROSOFT CORPORATION ©2020 DIGITALGLOBE ©CNES (2020) DISTRIBUTION AIRBUS DS

HORIZONTAL DATUM: OREGON STATE PLANE NORTH ZONE, NAD83, INTERNATIONAL FEET

VERTICAL DATUM: NORTH AMERICAN VERTICAL DATUM OF 1988 (NAVD88)

PERMIT-NOT FOR CONSTRUCTION

PLAN INTENDED TO BE VIEWED IN COLOR. ADJACENT BLOCK IS "BLUE" INCH SCALE ACCORDINGLY



REVISIONS				
REV	DATE	BY	APP'D	DESCRIPTION

DESIGNED BY: J. FOX
 DRAWN BY: D. HOLMER
 CHECKED BY: J. FOX
 APPROVED BY: G. SUMMERS
 SCALE: AS NOTED
 DATE: OCTOBER 2023

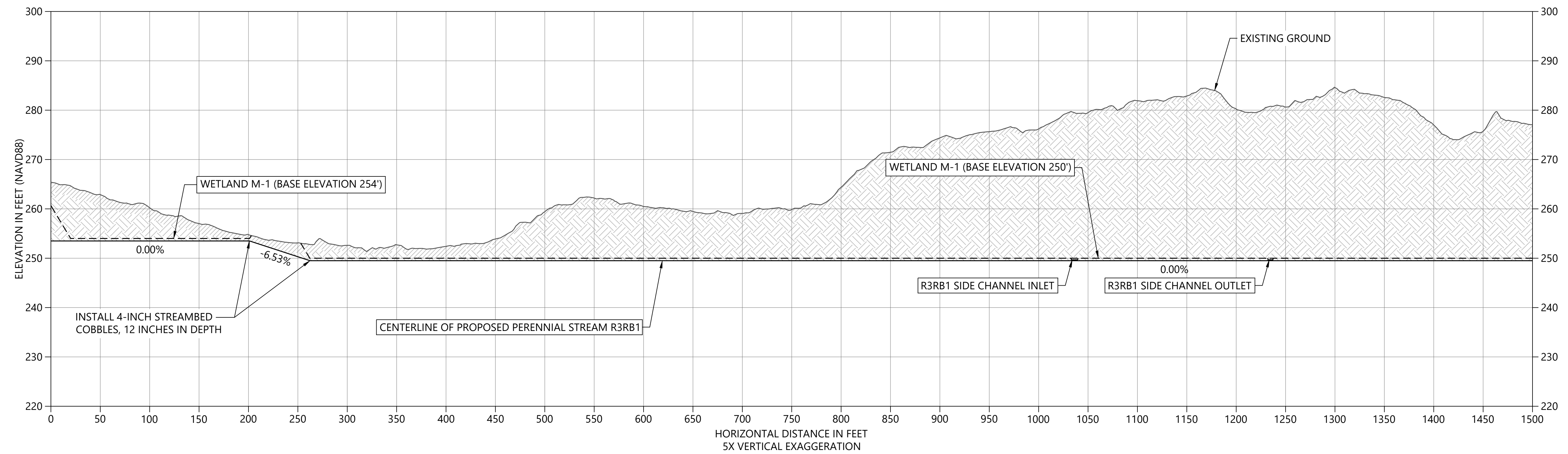
WATERS QUARRY PHASE II PROJECT
 KNIFE RIVER CORPORATION

PLAN VIEW OF WETLAND PREPARATION (SHEET 5 OF 5)

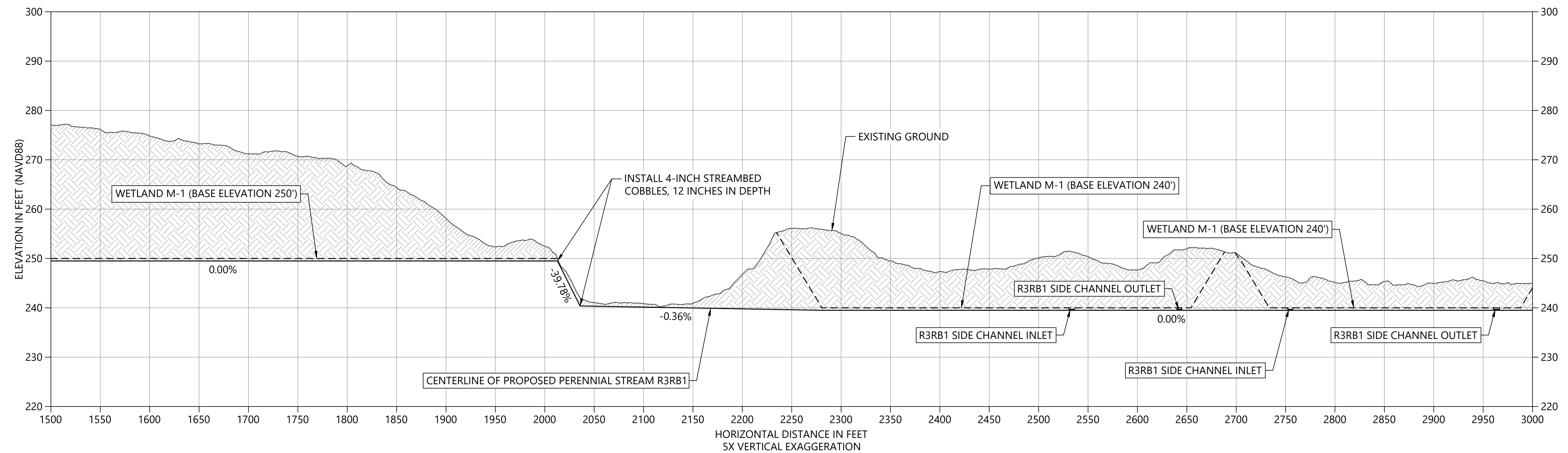
C6

SHEET # 9 OF 22

Profile (Section) for Alignment "ALIGNMENT-DRAINAGE CORRIDOR-20220609"



Profile (Section) for Alignment "ALIGNMENT-DRAINAGE CORRIDOR-20220609"



- LEGEND:
- STREAM GRADE
 - - - WETLAND GRADE
 - ▨ ESTIMATED DEPTH OF SOIL EXCAVATION
 - ▩ ESTIMATED DEPTH OF BEDROCK EXCAVATION

PLAN INTENDED TO BE VIEWED IN COLOR. ADJACENT BLOCK IS "BLUE".

ONE INCH AT FULL SIZE. IF NOT ONE INCH SCALE ACCORDINGLY.

PERMIT-NOT FOR CONSTRUCTION



REVISIONS				
REV	DATE	BY	APP'D	DESCRIPTION

DESIGNED BY: J. FOX
 DRAWN BY: D. HOLMER
 CHECKED BY: J. FOX
 APPROVED BY: G. SUMMERS
 SCALE: AS NOTED
 DATE: OCTOBER 2023

WATERS QUARRY PHASE II PROJECT
 KNIFE RIVER CORPORATION

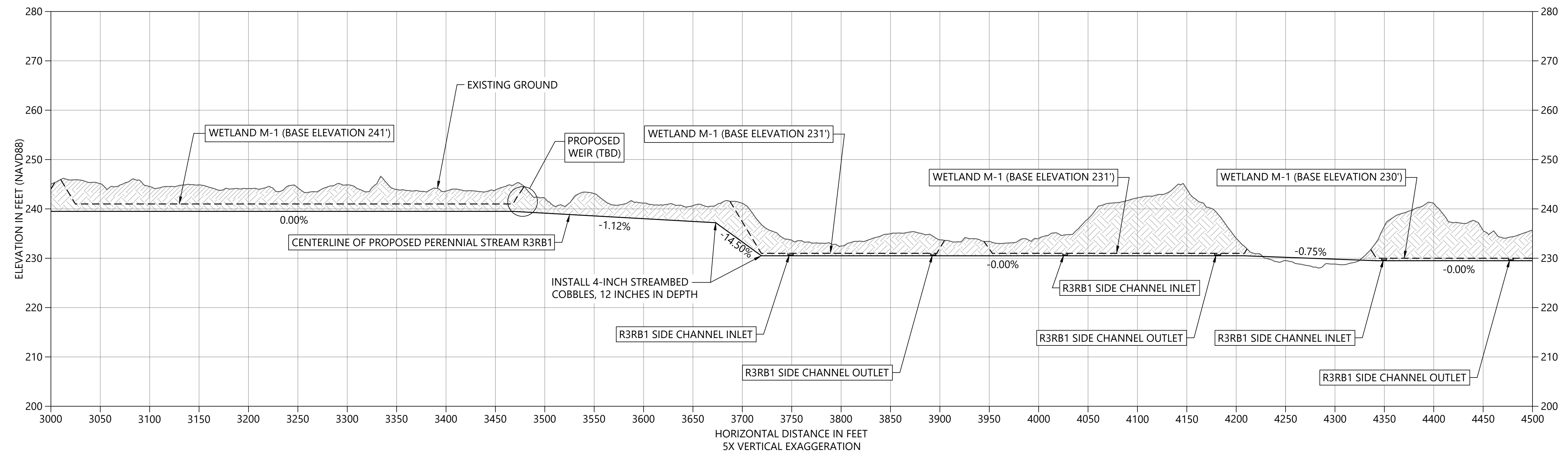
PROFILE ALONG CENTERLINE ALIGNMENT OF PROPOSED DRAINAGE CORRIDOR (SHEET 1 OF 2)

C7

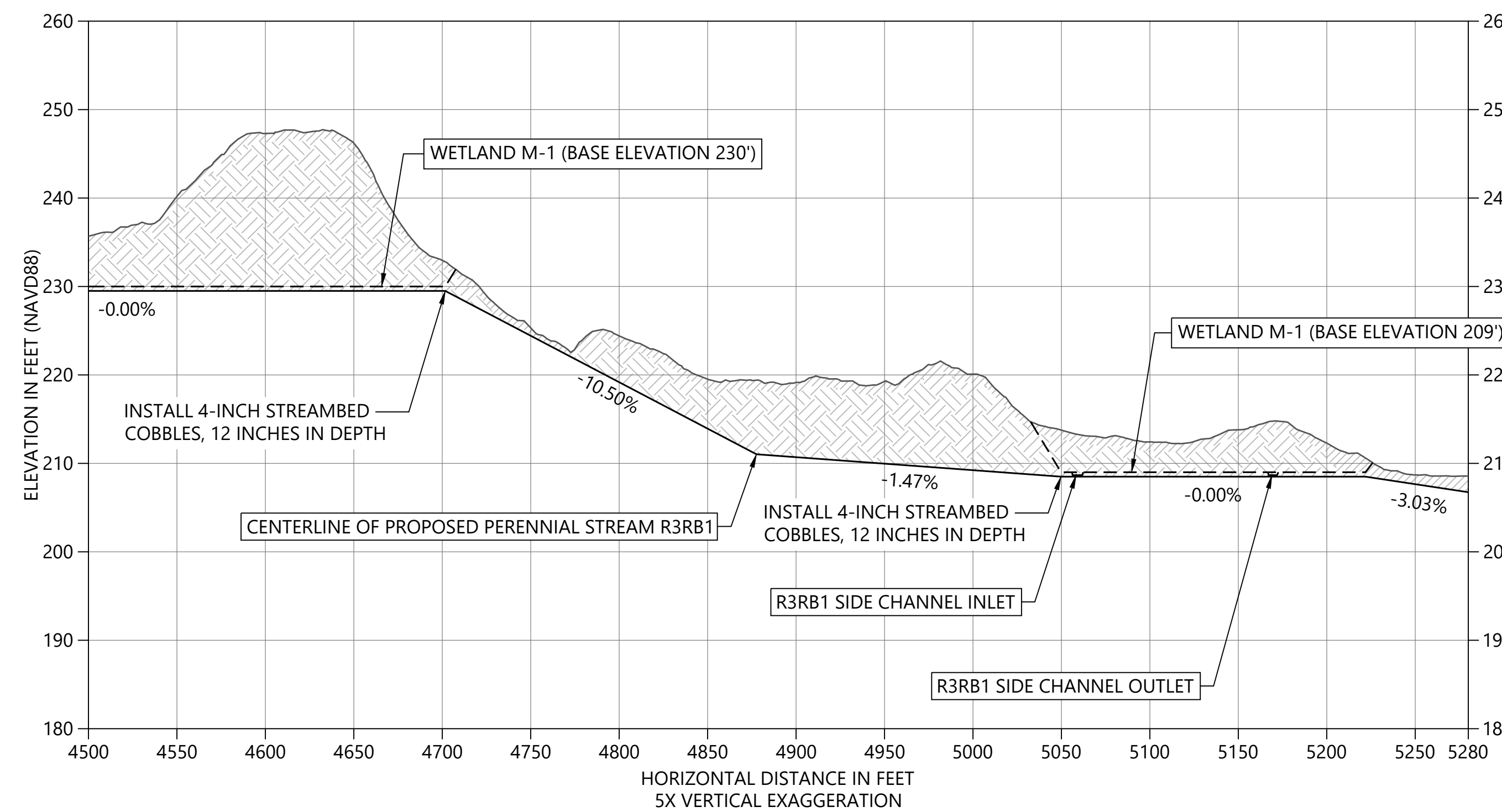
SHEET # 10 OF 22

K:\Projects\2114-Knife River Corporation-NWA\Waters Quarry Expansion\Construction Plans\2114-C-SERIES.dwg C7
 Nov 20, 2023 12:56pm chawett

Profile (Section) for Alignment "ALIGNMENT-DRAINAGE CORRIDOR-20220609"



Profile (Section) for Alignment "ALIGNMENT-DRAINAGE CORRIDOR-20220609"



- LEGEND:
- STREAM GRADE
 - - - WETLAND GRADE
 - ▨ ESTIMATED DEPTH OF SOIL EXCAVATION
 - ▩ ESTIMATED DEPTH OF BEDROCK EXCAVATION

PLAN INTENDED TO BE VIEWED
IN COLOR. ADJACENT BLOCK IS
"BLUE"
ONE INCH
AT FULL SIZE. IF NOT ONE
INCH SCALE ACCORDINGLY

PERMIT-NOT FOR CONSTRUCTION



REVISIONS				
REV	DATE	BY	APP'D	DESCRIPTION

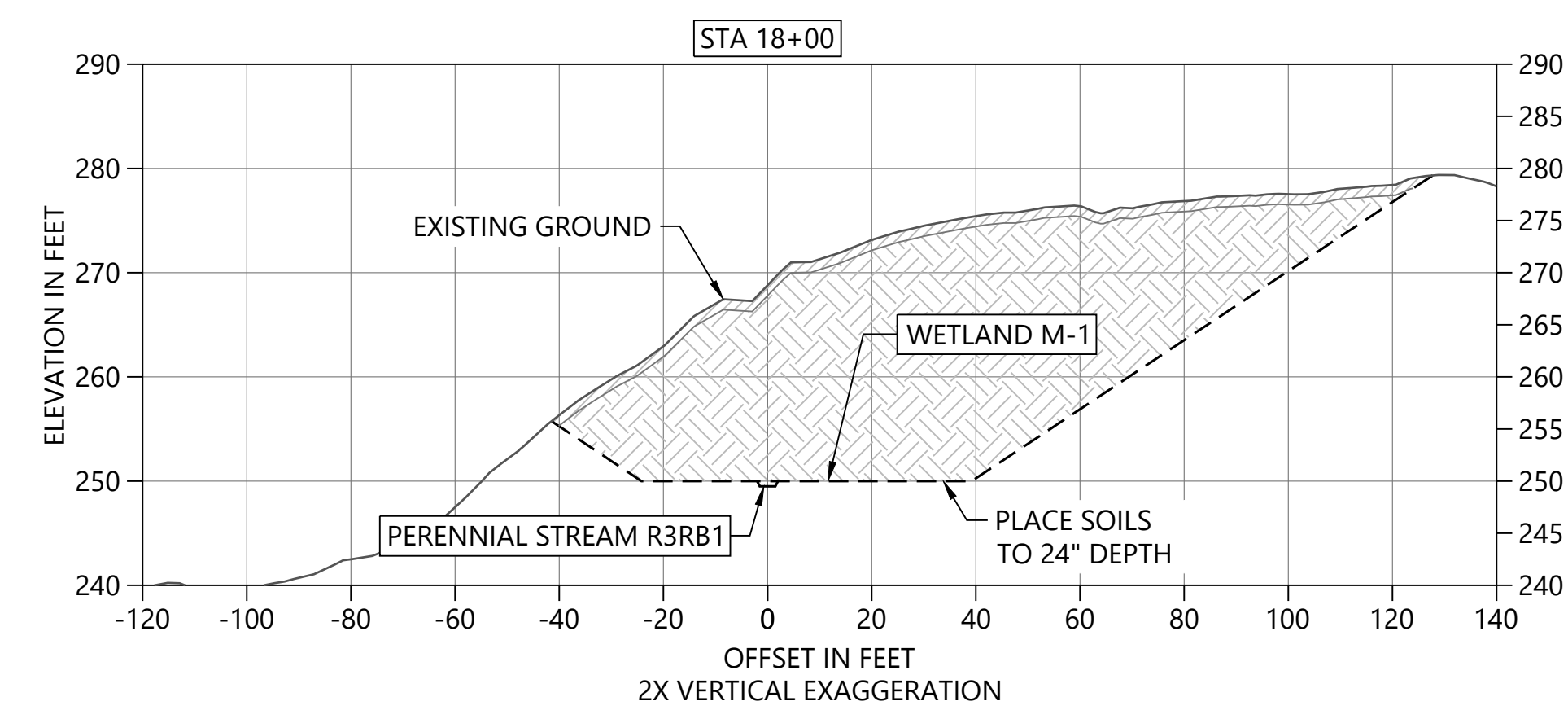
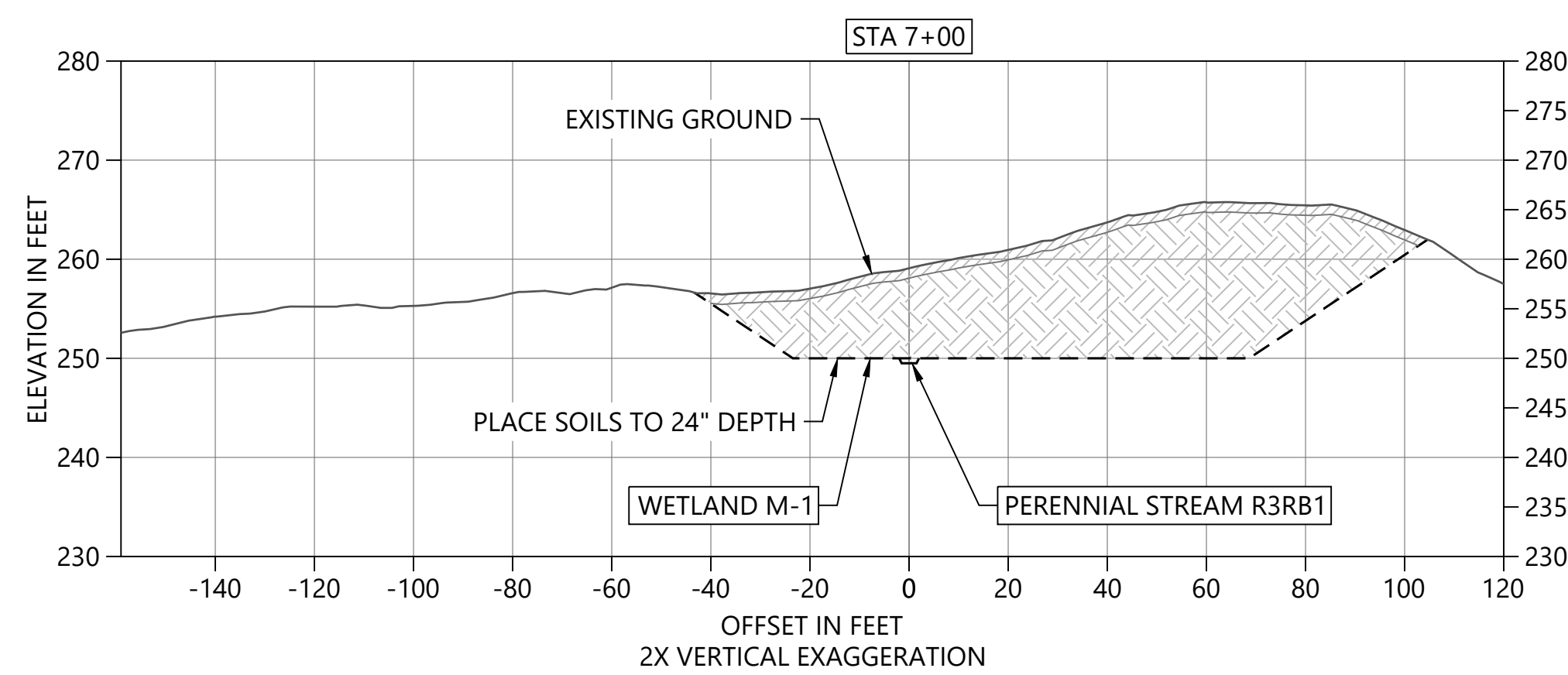
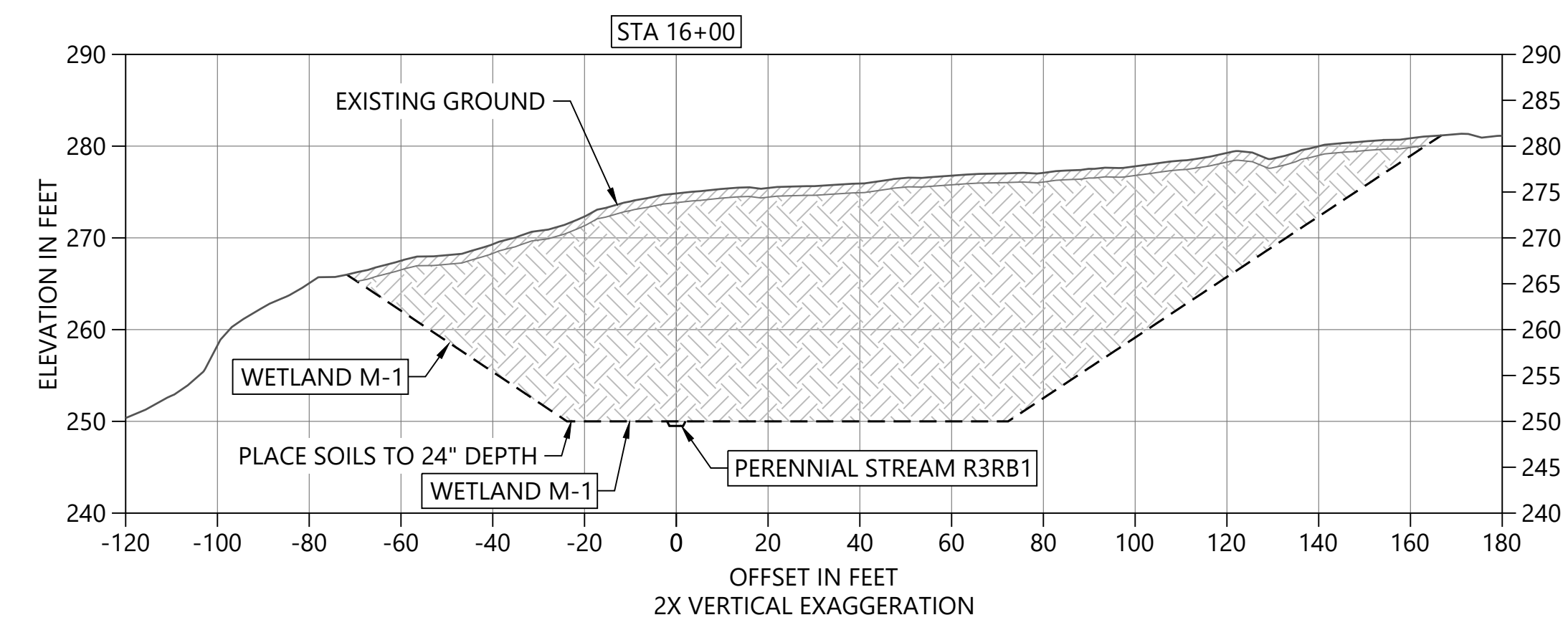
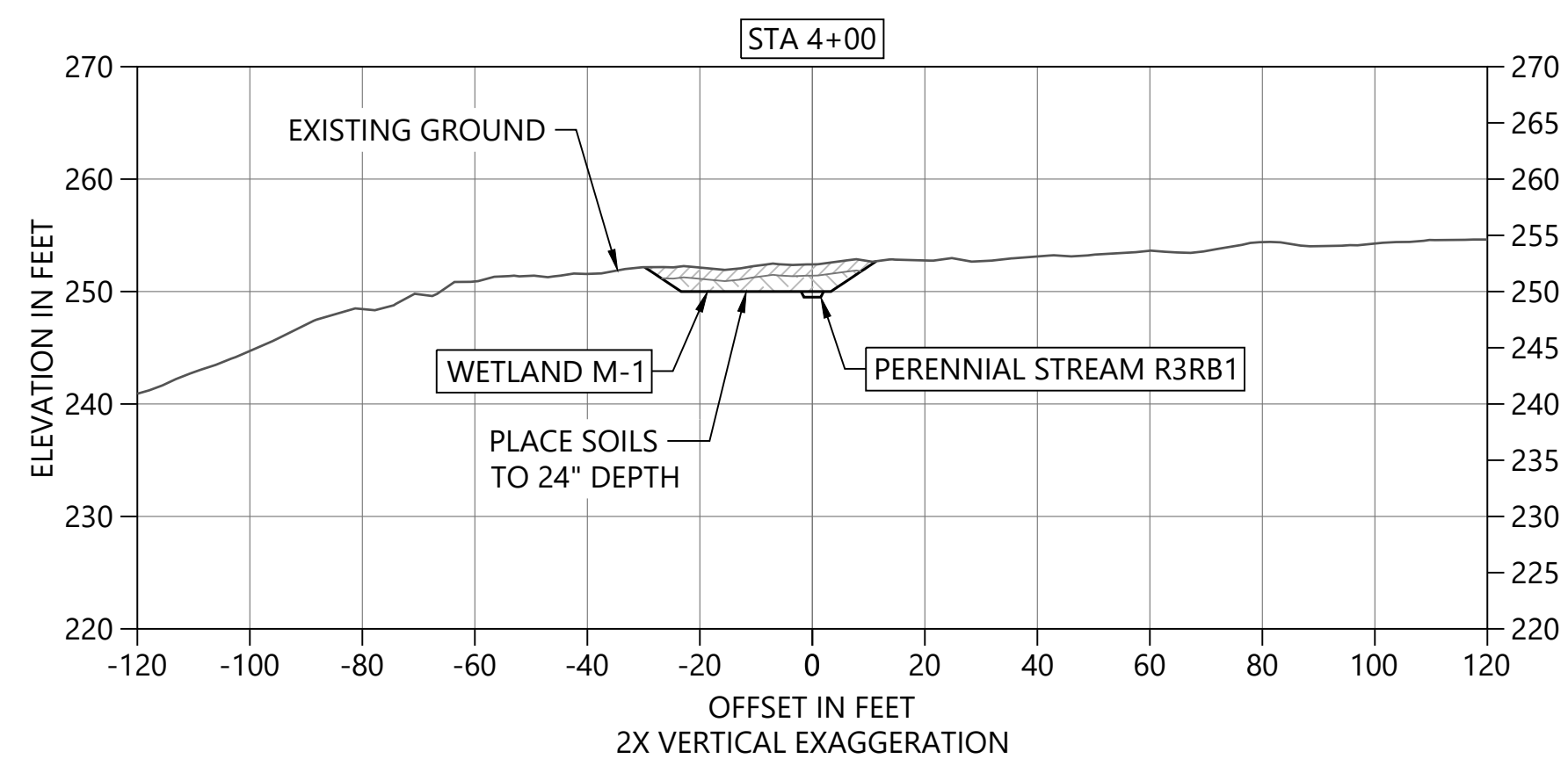
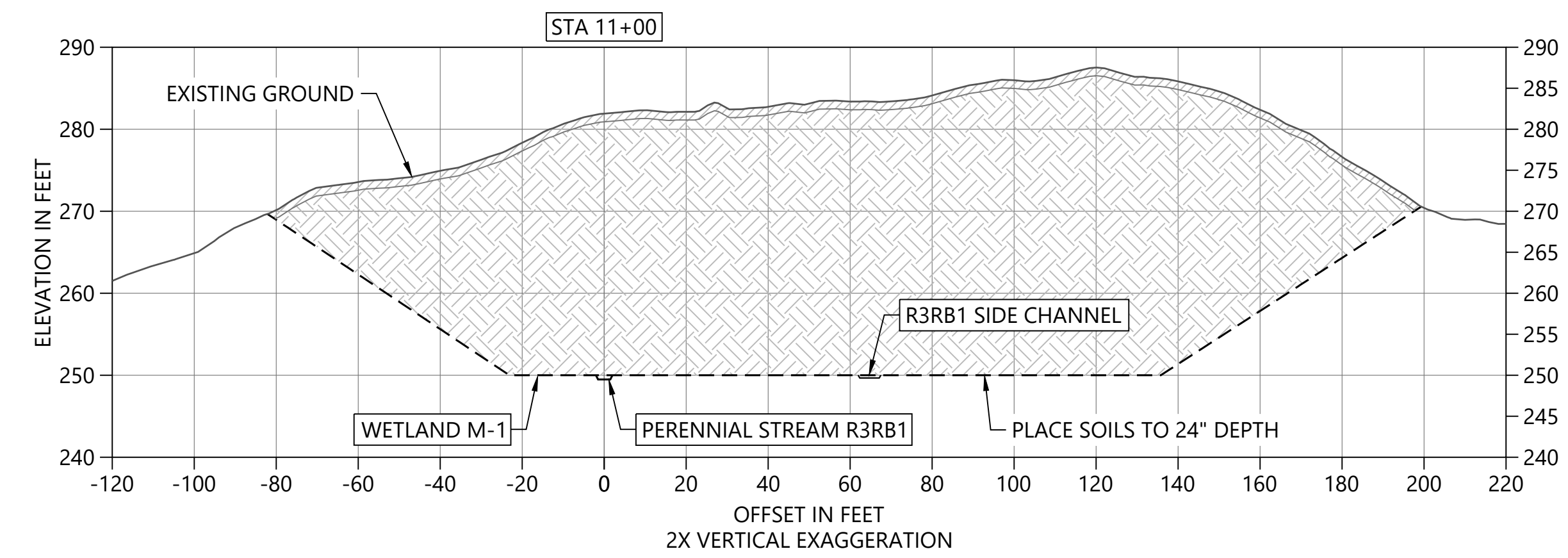
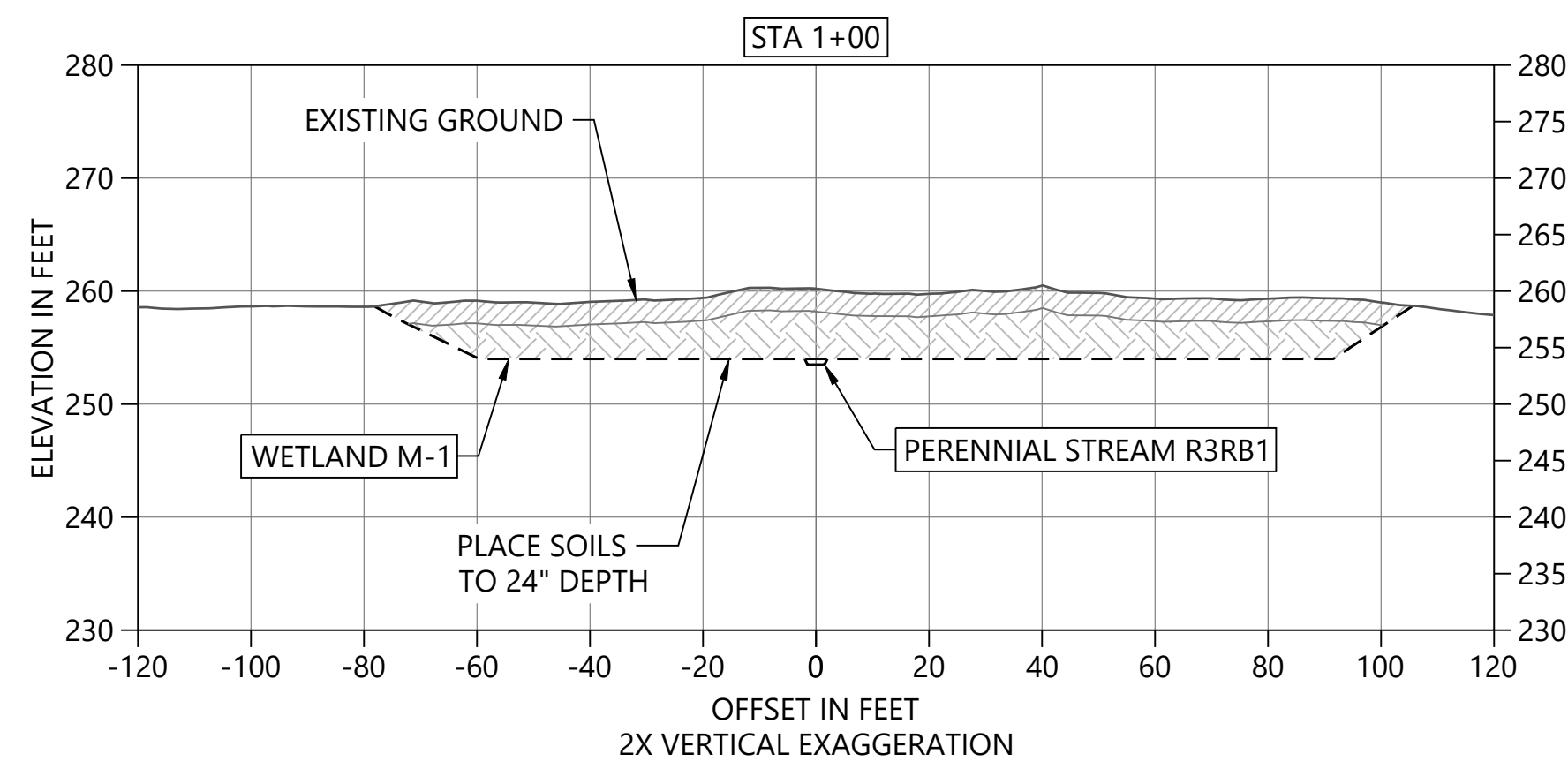
DESIGNED BY: J. FOX
 DRAWN BY: D. HOLMER
 CHECKED BY: J. FOX
 APPROVED BY: G. SUMMERS
 SCALE: AS NOTED
 DATE: OCTOBER 2023

WATERS QUARRY PHASE II PROJECT
KNIFE RIVER CORPORATION

PROFILE ALONG CENTERLINE ALIGNMENT
OF PROPOSED DRAINAGE CORRIDOR
(SHEET 2 OF 2)

C8

SHEET # 11 OF 22



- LEGEND:
- STREAM GRADE
 - - - WETLAND GRADE
 - ▨ ESTIMATED DEPTH OF SOIL EXCAVATION
 - ▩ ESTIMATED DEPTH OF BEDROCK EXCAVATION

ONE INCH
↑
AT FULL SIZE, IF NOT ONE
INCH SCALE ACCORDINGLY
↓
PLAN INTENDED TO BE VIEWED
IN COLOR. ADJACENT BLOCK IS
"BLUE"

PERMIT-NOT FOR CONSTRUCTION



REVISIONS				
REV	DATE	BY	APP'D	DESCRIPTION

DESIGNED BY: J. FOX
 DRAWN BY: D. HOLMER
 CHECKED BY: J. FOX
 APPROVED BY: G. SUMMERS
 SCALE: AS NOTED
 DATE: OCTOBER 2023

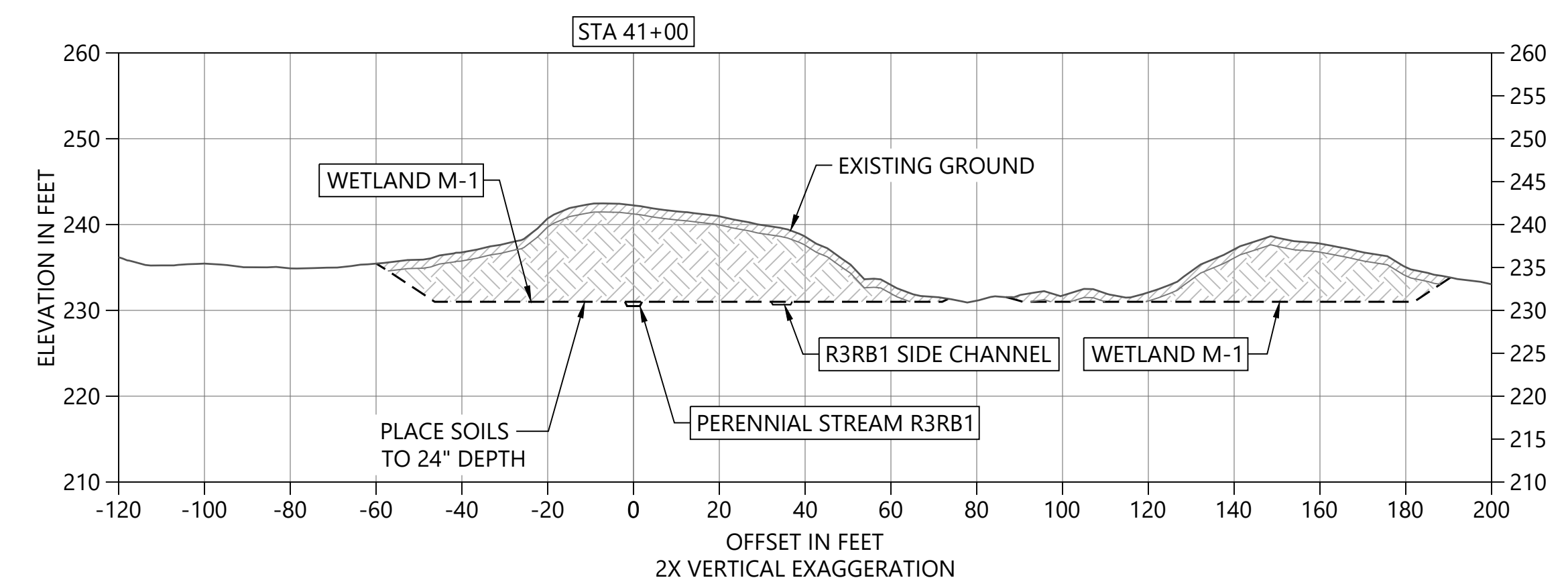
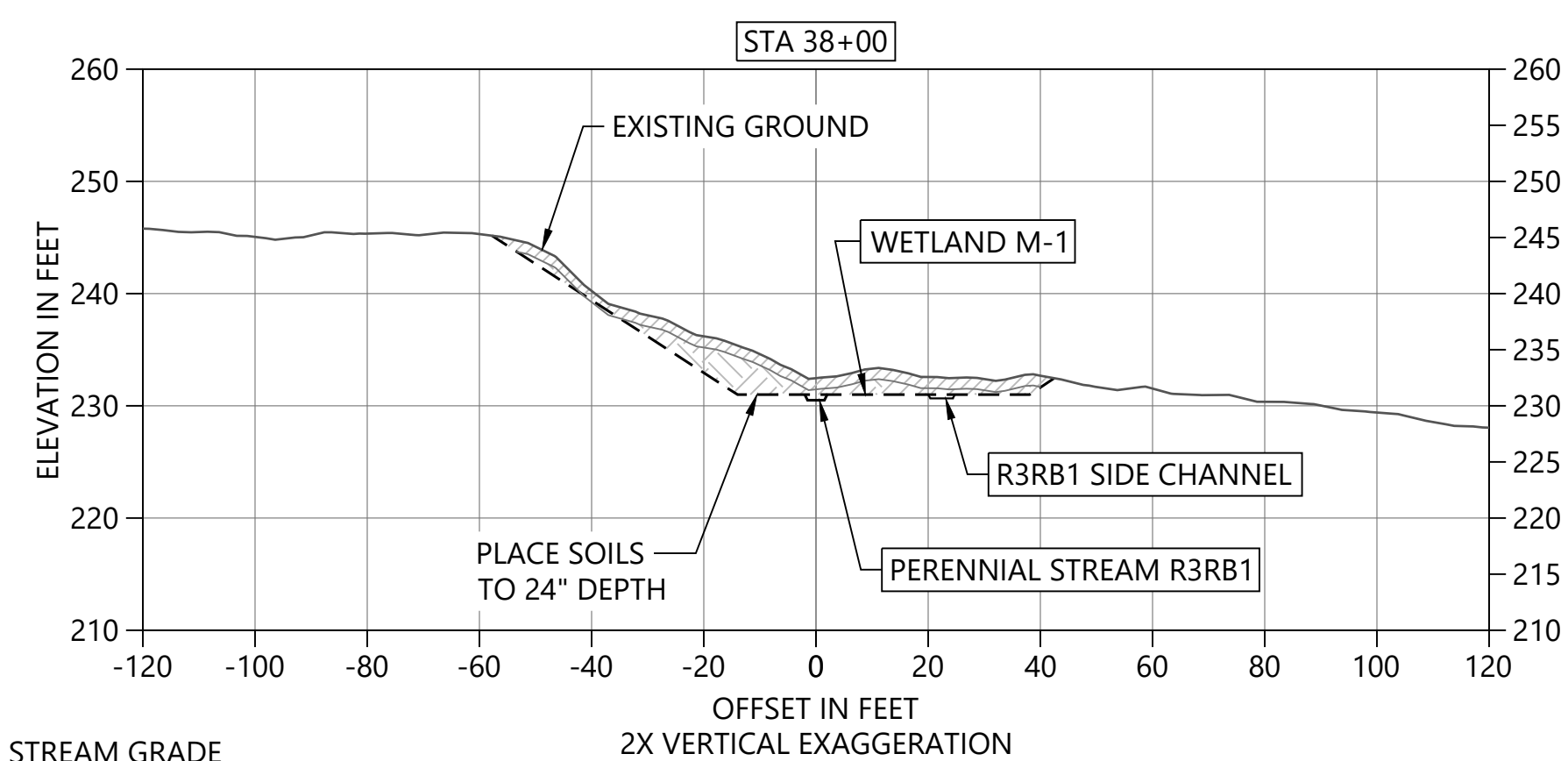
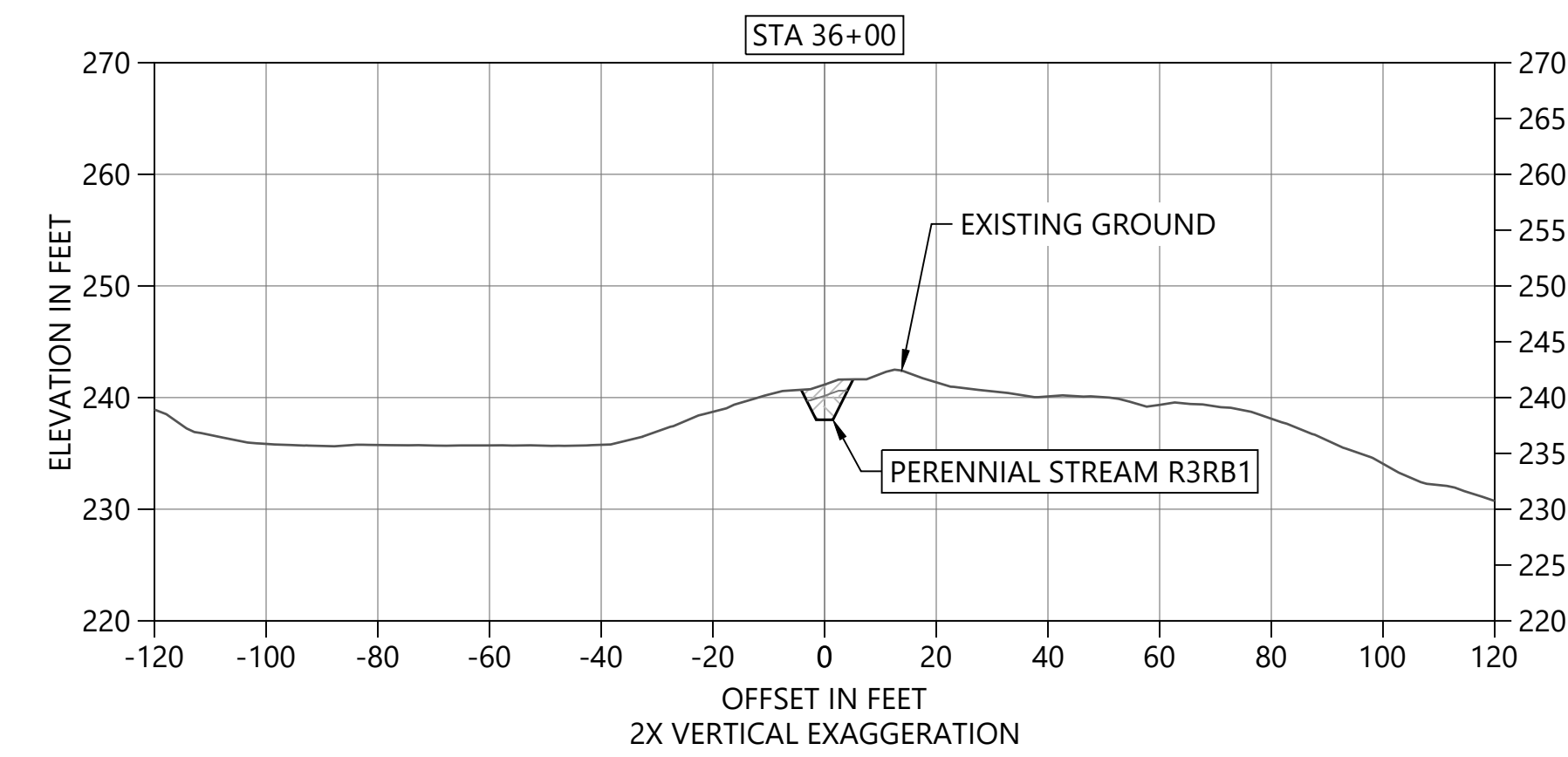
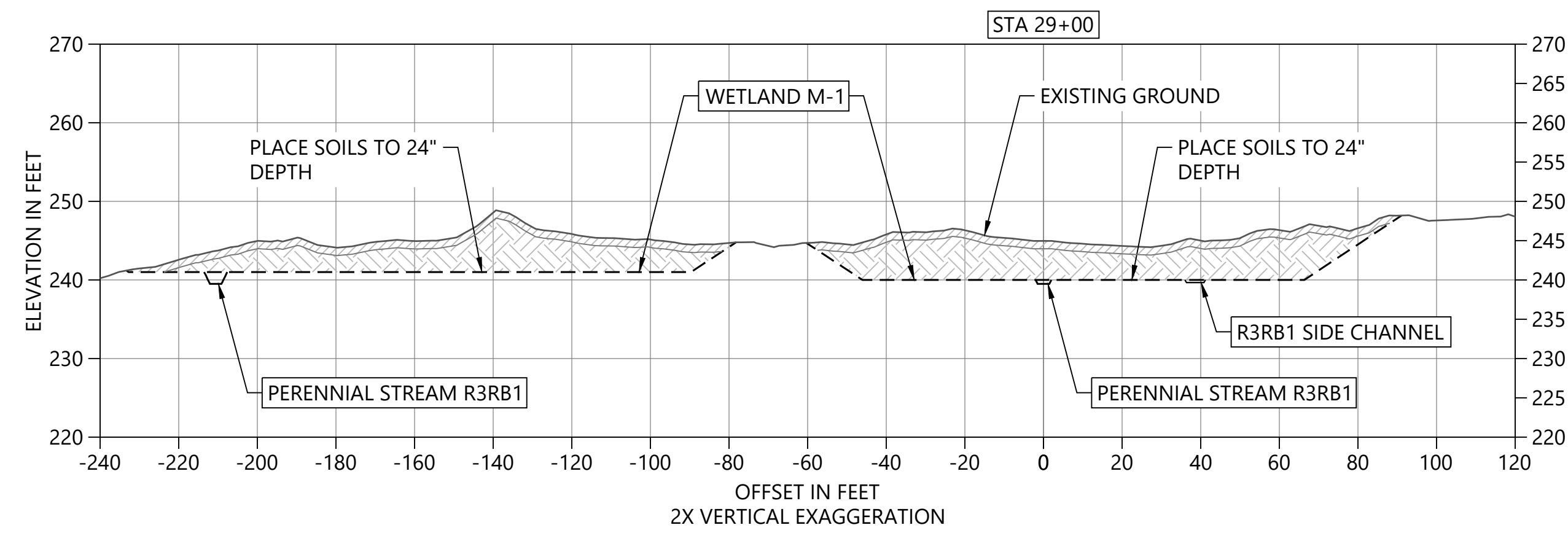
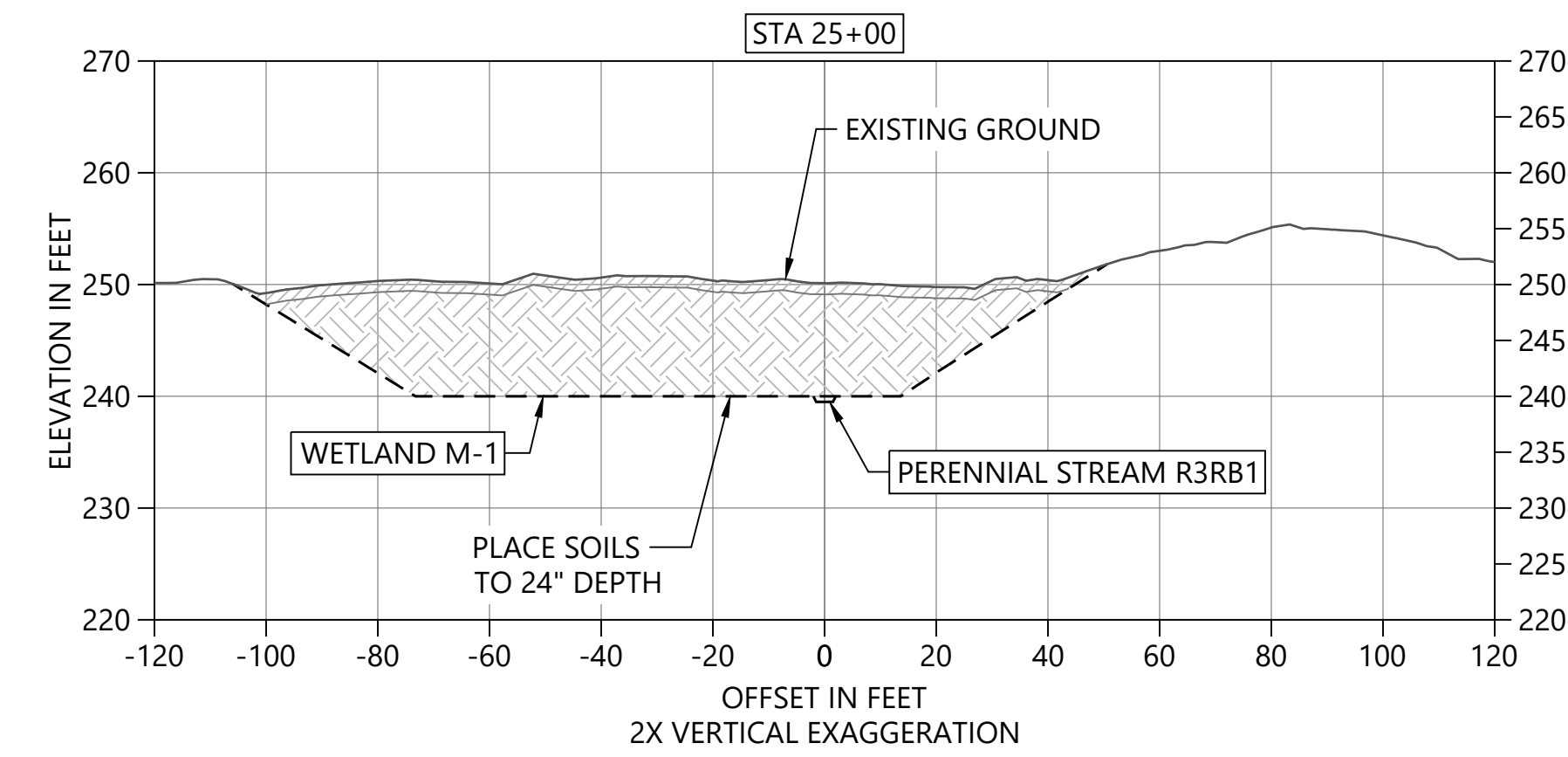
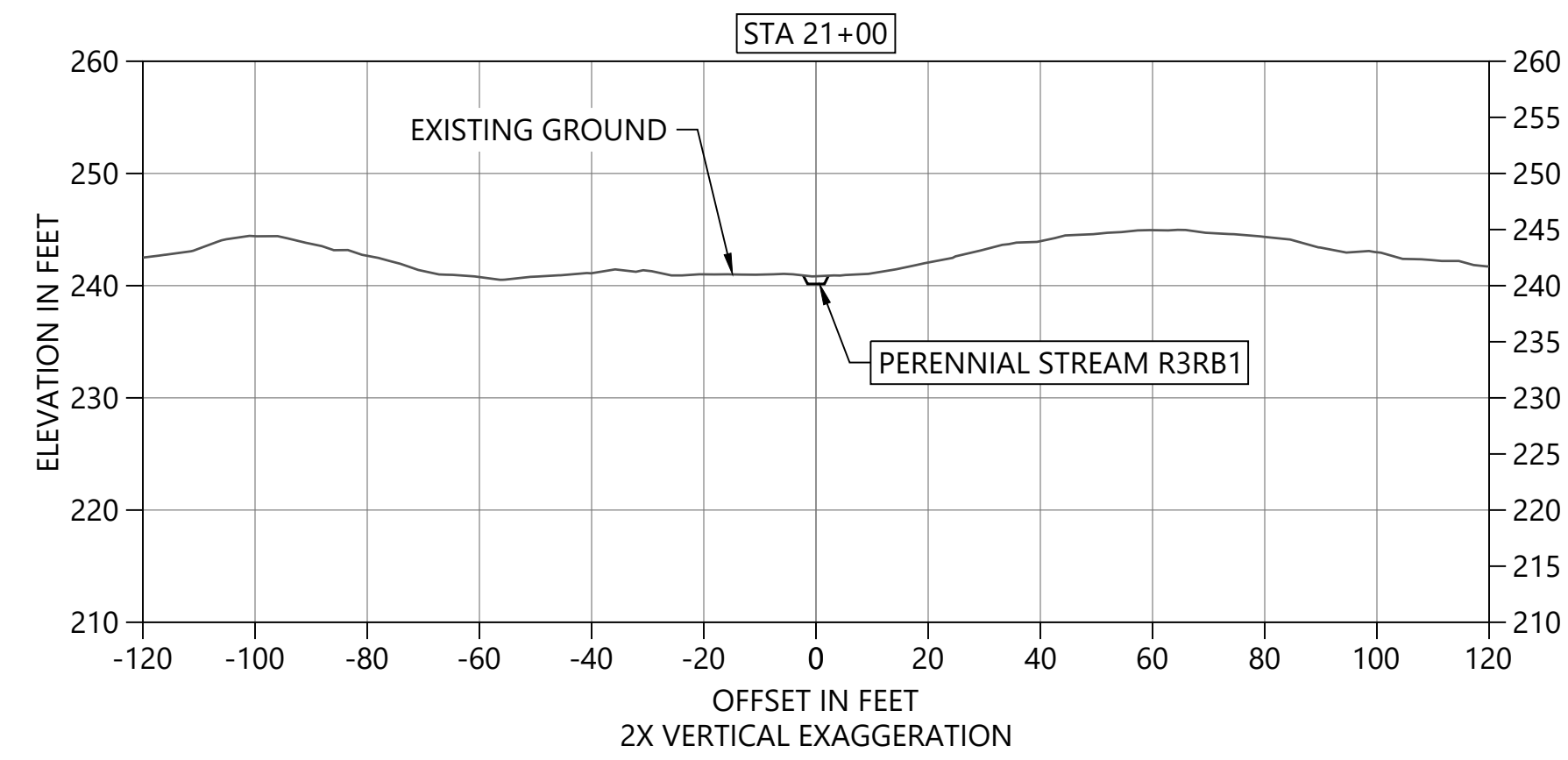
WATERS QUARRY PHASE II PROJECT
KNIFE RIVER CORPORATION

**CROSS SECTIONS ALONG PROPOSED
 DRAINAGE CORRIDOR (SHEET 1 OF 4)**

C9

SHEET # 12 OF 22

K:\Projects\2114-Knife River Corporation-Waters Quarry Expansion\Construction Plans\2114-C-SERIES.dwg C9
 Nov 30, 2023 12:57pm chawett



- LEGEND:
- STREAM GRADE
 - - - WETLAND GRADE
 - ▨ ESTIMATED DEPTH OF SOIL EXCAVATION
 - ▩ ESTIMATED DEPTH OF BEDROCK EXCAVATION

ONE INCH
 AT FULL SIZE, IF NOT ONE
 INCH SCALE ACCORDINGLY

PLAN INTENDED TO BE VIEWED
 IN COLOR. ADJACENT BLOCK IS
 "BLUE"

PERMIT-NOT FOR CONSTRUCTION

K:\Projects\2114-Knife River Corporation-NWA\Waters Quarry Expansion\Construction Plans\2114-C-SERIES.dwg C10 Nov 30, 2023 12:57pm chawett



REVISIONS				
REV	DATE	BY	APP'D	DESCRIPTION

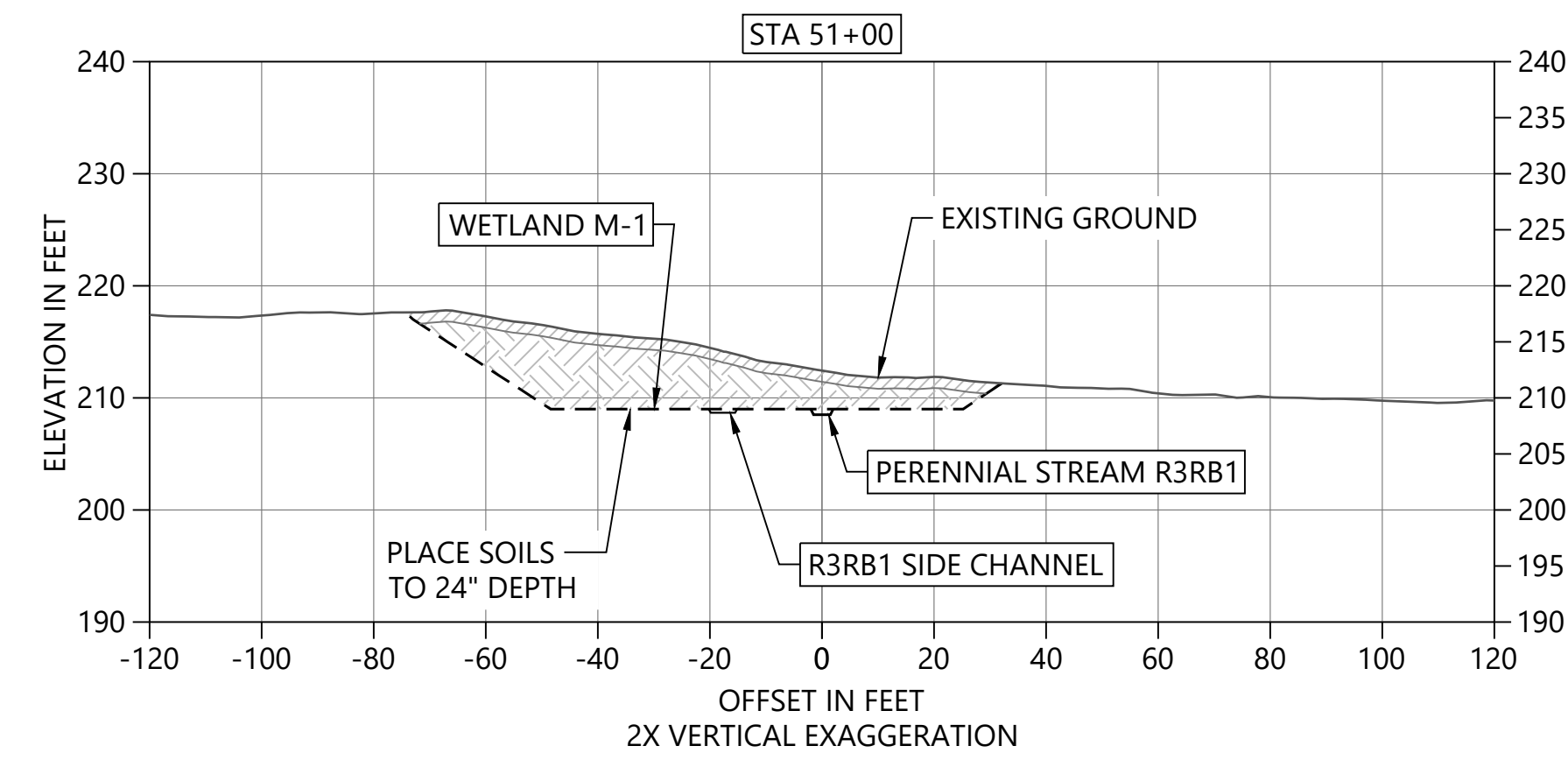
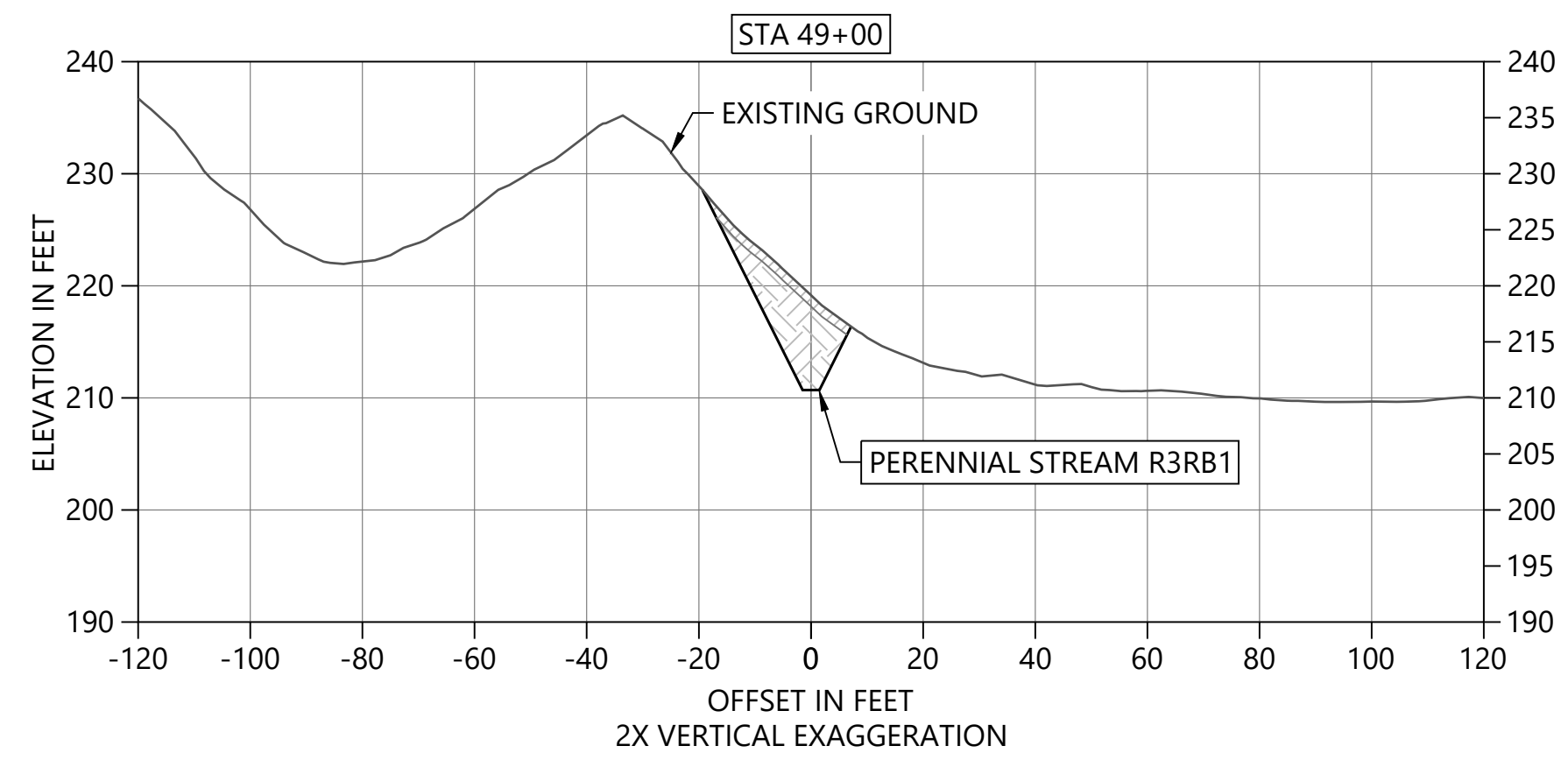
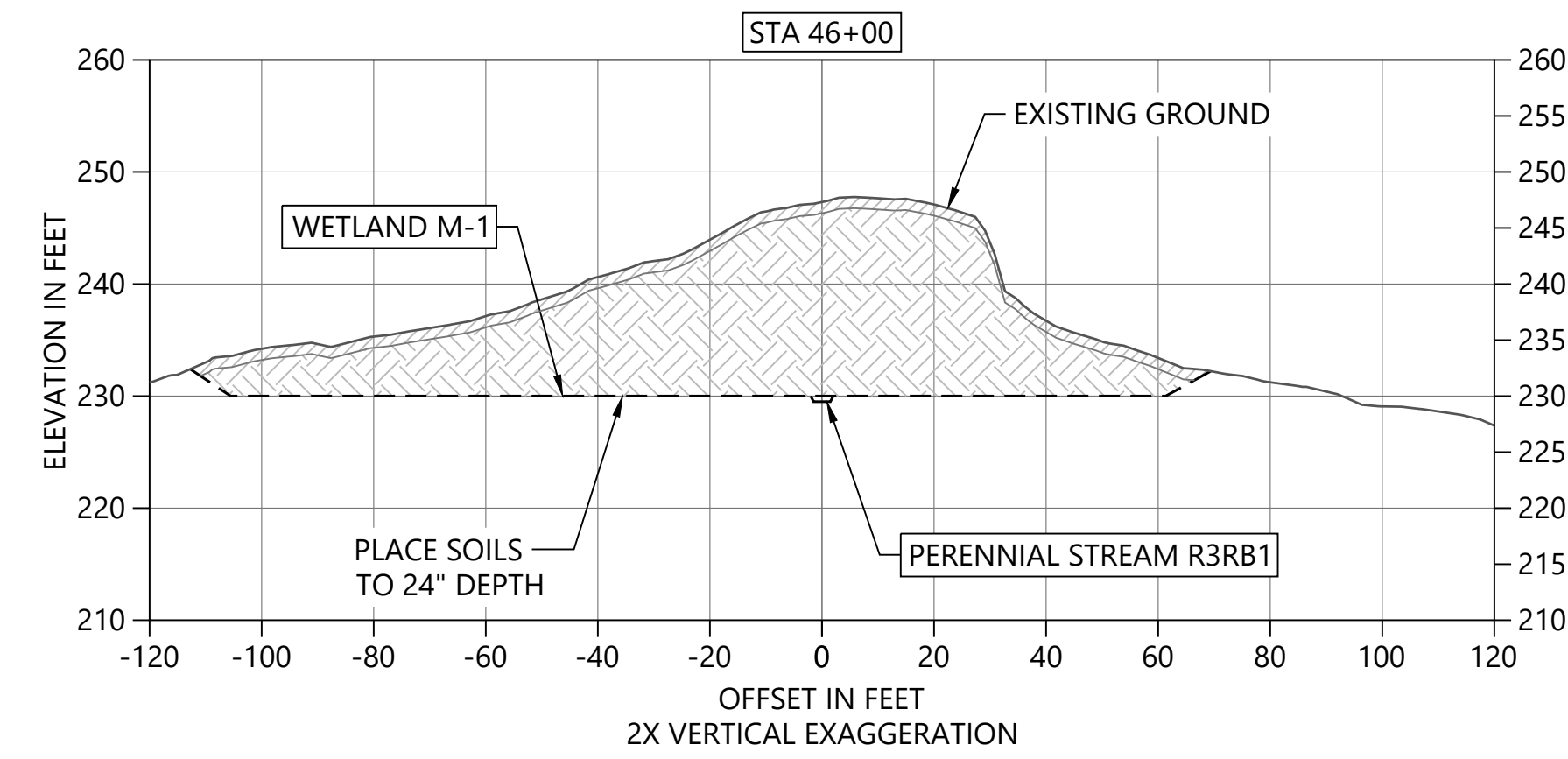
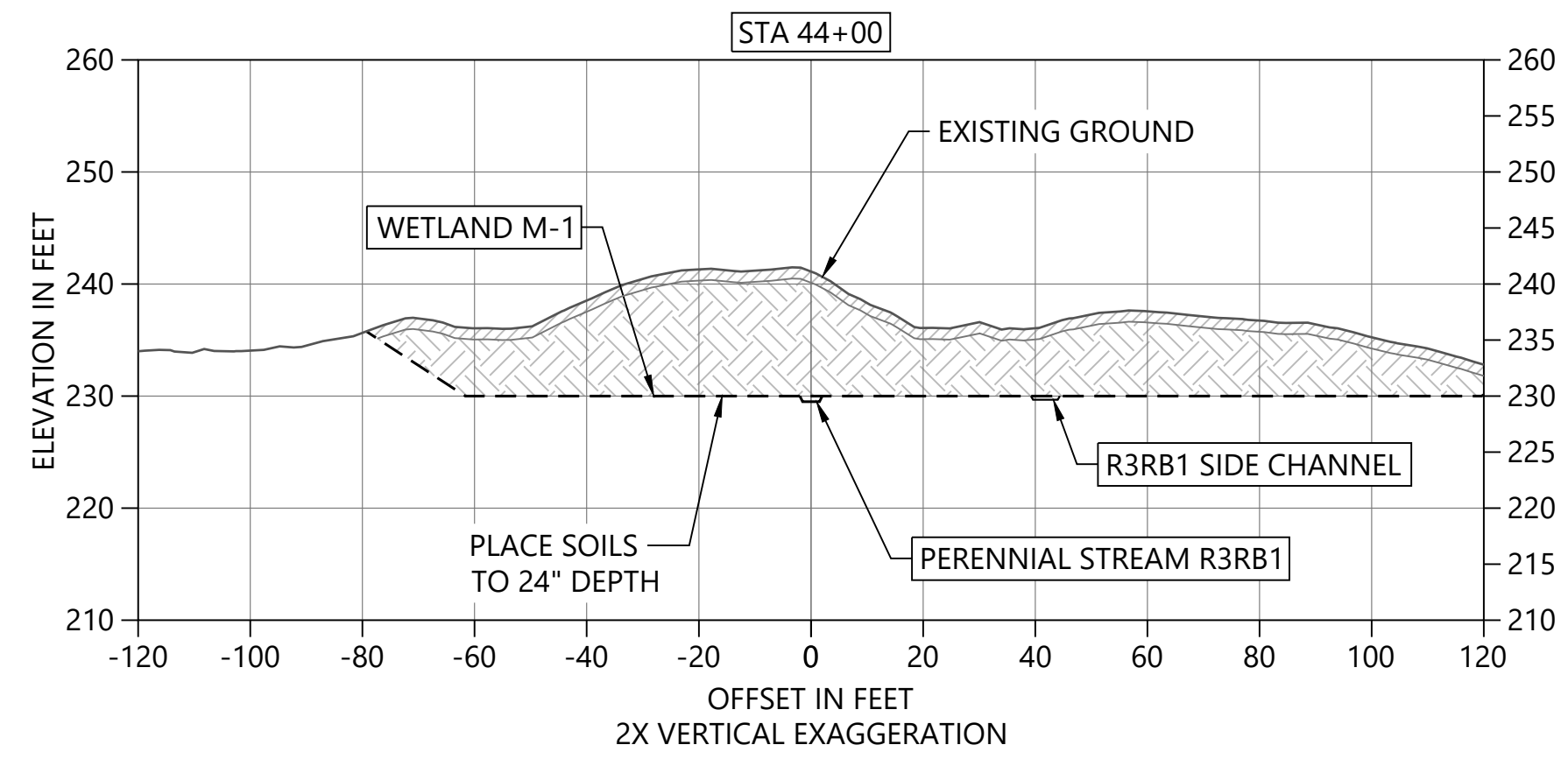
DESIGNED BY: J. FOX
 DRAWN BY: D. HOLMER
 CHECKED BY: J. FOX
 APPROVED BY: G. SUMMERS
 SCALE: AS NOTED
 DATE: OCTOBER 2023

WATERS QUARRY PHASE II PROJECT
KNIFE RIVER CORPORATION

CROSS SECTIONS ALONG PROPOSED DRAINAGE CORRIDOR (SHEET 4 OF 4)

C10

SHEET # 13 OF 22



- LEGEND:
- STREAM GRADE
 - - - WETLAND GRADE
 - ▨ ESTIMATED DEPTH OF SOIL EXCAVATION
 - ▩ ESTIMATED DEPTH OF BEDROCK EXCAVATION

ONE INCH
↑
AT FULL SIZE, IF NOT ONE
INCH SCALE ACCORDINGLY
↓
PLAN INTENDED TO BE VIEWED
IN COLOR, ADJACENT BLOCK IS
"BLUE"

PERMIT-NOT FOR CONSTRUCTION

K:\Projects\2114-Knife River Corporation-NWA\Waters Quarry Expansion\Construction Plans\2114-C-SERIES.dwg C11
Nov 30, 2023 12:57pm chawett



REVISIONS				
REV	DATE	BY	APP'D	DESCRIPTION

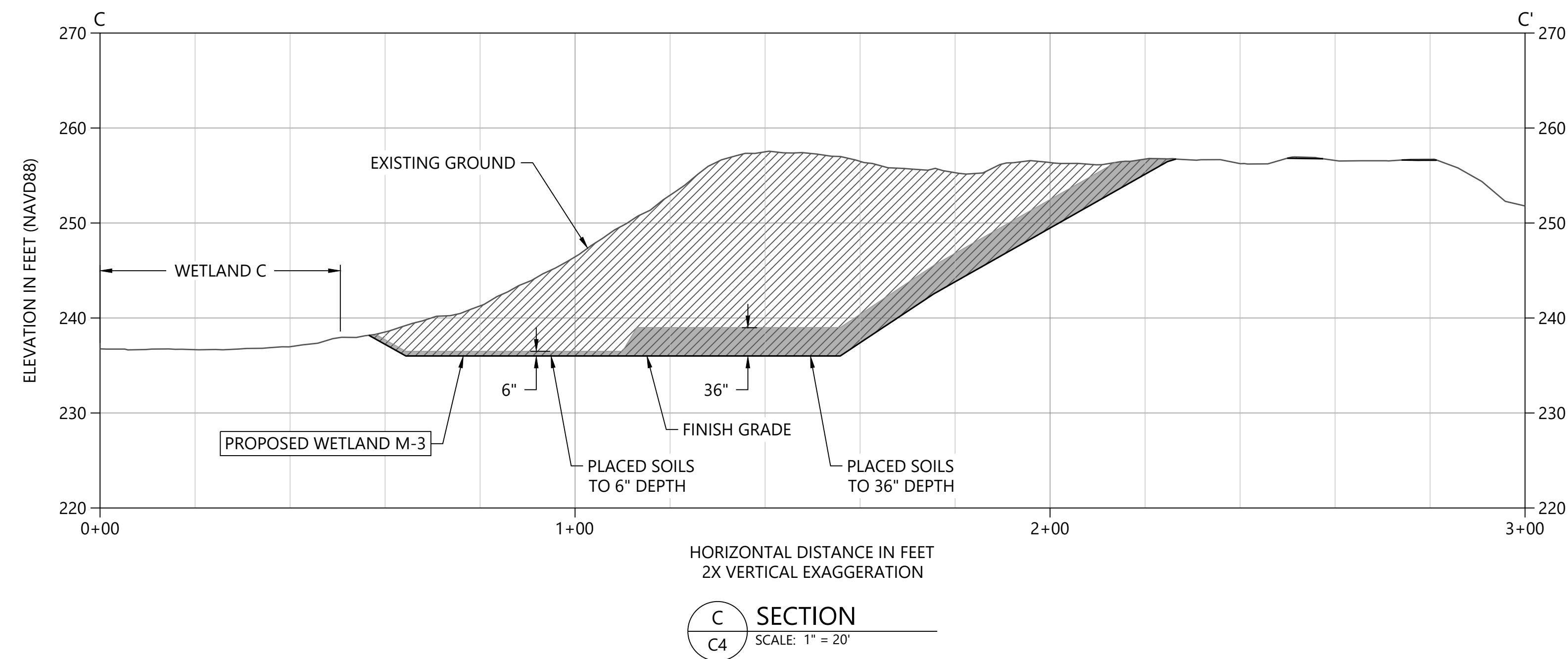
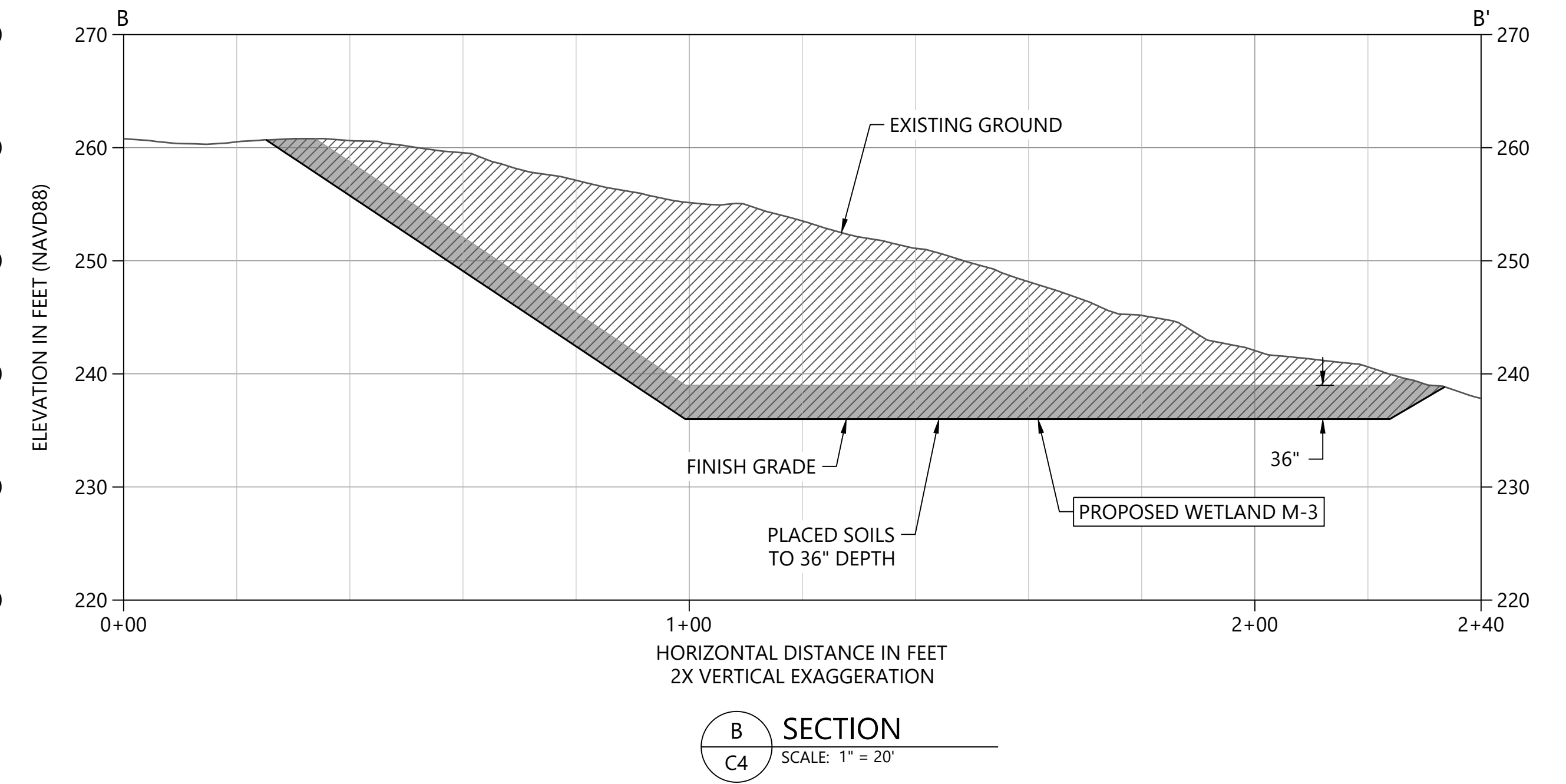
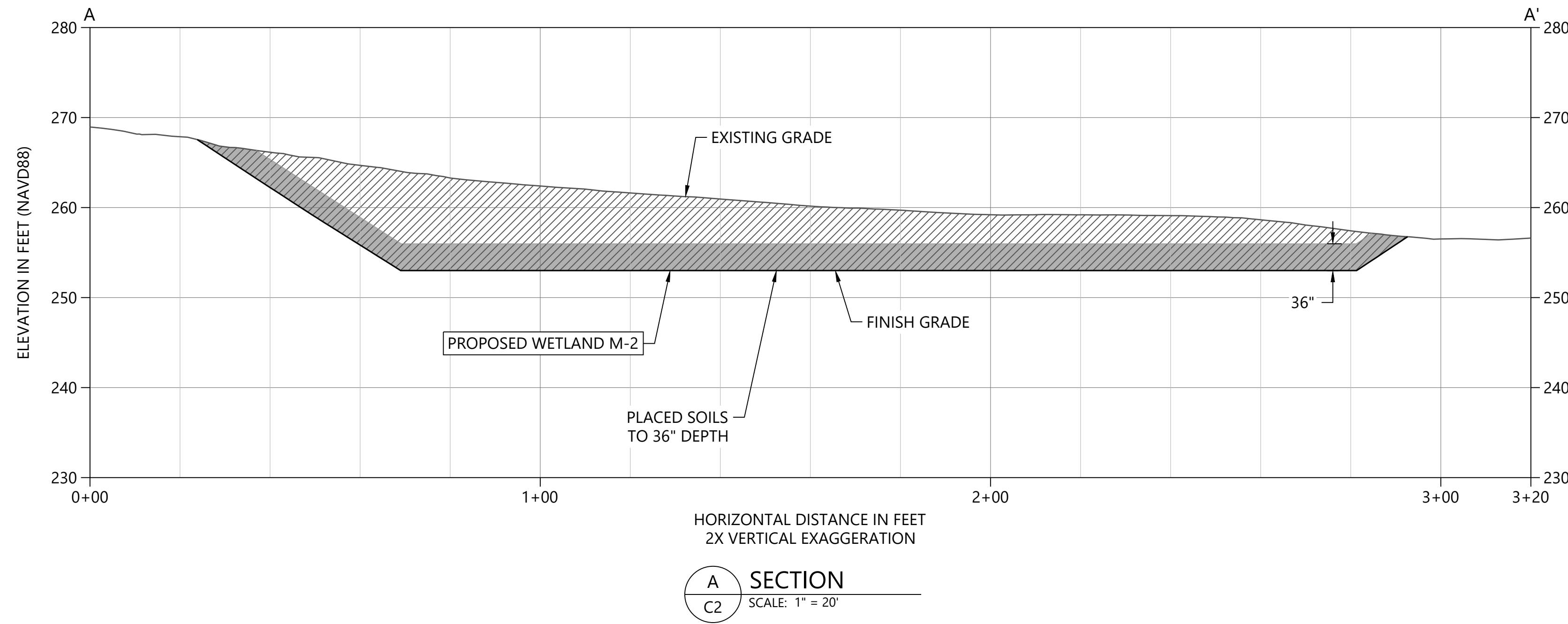
DESIGNED BY: J. FOX
 DRAWN BY: D. HOLMER
 CHECKED BY: J. FOX
 APPROVED BY: G. SUMMERS
 SCALE: AS NOTED
 DATE: OCTOBER 2023

WATERS QUARRY PHASE II PROJECT
KNIFE RIVER CORPORATION

CROSS SECTIONS THROUGH WETLAND
PREPARATION GRADING AREAS (SHEET 1 OF 2)

C11

SHEET # 14 OF 22



LEGEND:
 EXCAVATE EXISTING SOILS AND BEDROCK
 PLACED SOILS

PLAN INTENDED TO BE VIEWED
IN COLOR. ADJACENT BLOCK IS
"BLUE"
ONE INCH
AT FULL SIZE. IF NOT ONE
INCH SCALE ACCORDINGLY

PERMIT-NOT FOR CONSTRUCTION



REVISIONS				
REV	DATE	BY	APP'D	DESCRIPTION

DESIGNED BY: J. FOX
 DRAWN BY: D. HOLMER
 CHECKED BY: J. FOX
 APPROVED BY: G. SUMMERS
 SCALE: AS NOTED
 DATE: OCTOBER 2023

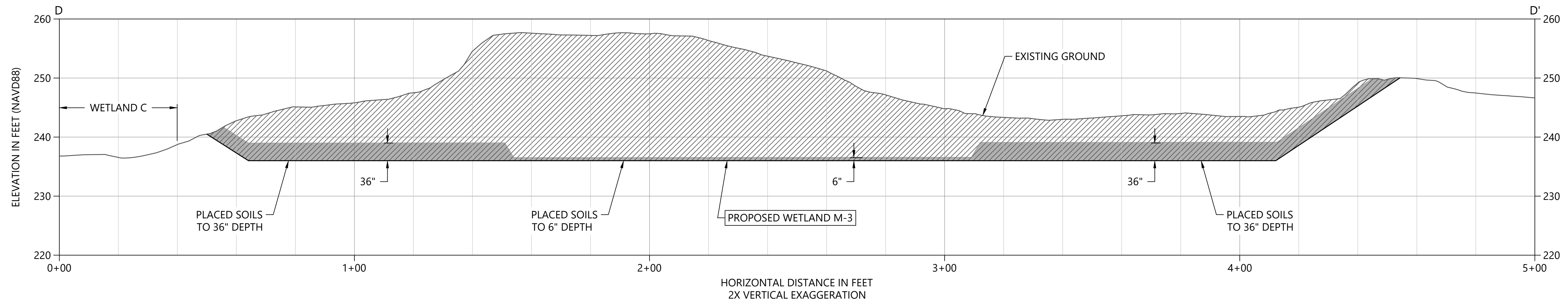
WATERS QUARRY PHASE II PROJECT
 KNIFE RIVER CORPORATION

**CROSS SECTIONS THROUGH WETLAND
 PREPARATION GRADING AREAS (SHEET 1 OF 2)**

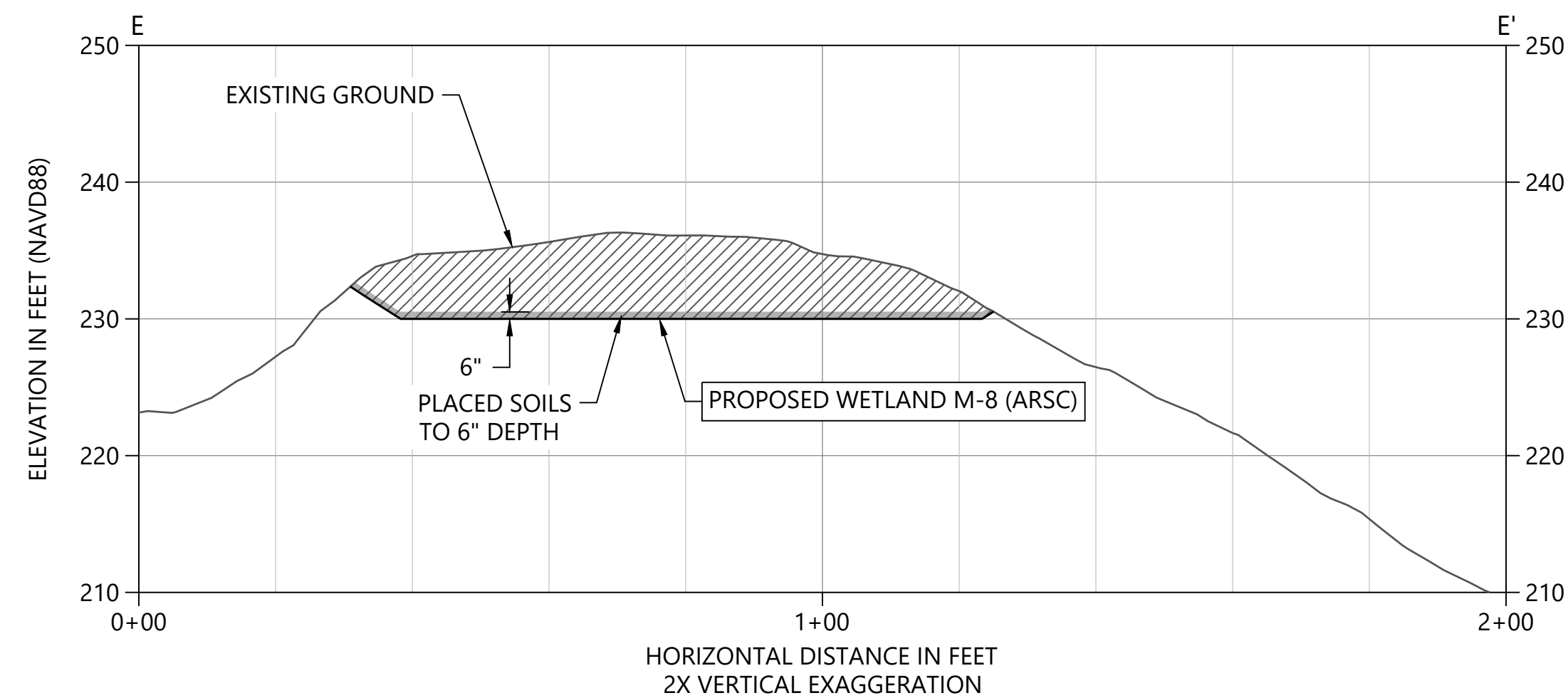
C12

SHEET # 15 OF 22

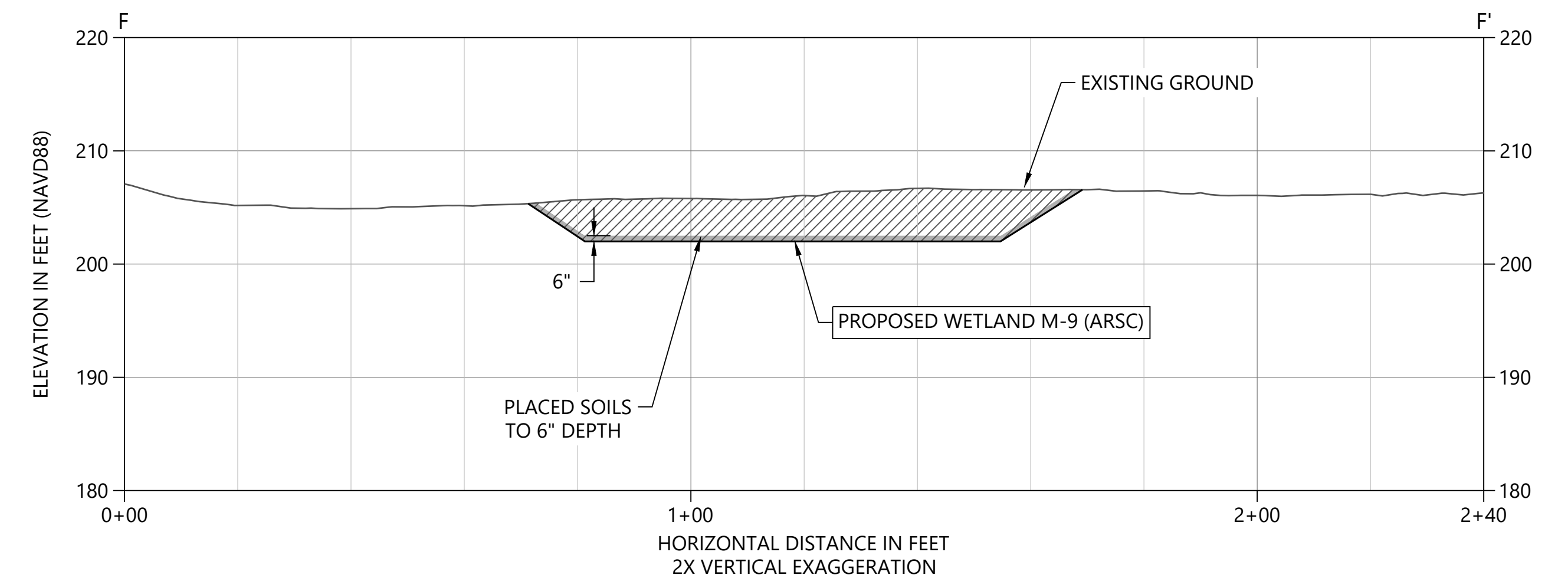
K:\Projects\32114-Knife River Corporation-NW\Waters Quarry Expansion\Construction Plans\2114-C-SERIES.dwg C12 Nov 20, 2023 12:57pm chawett



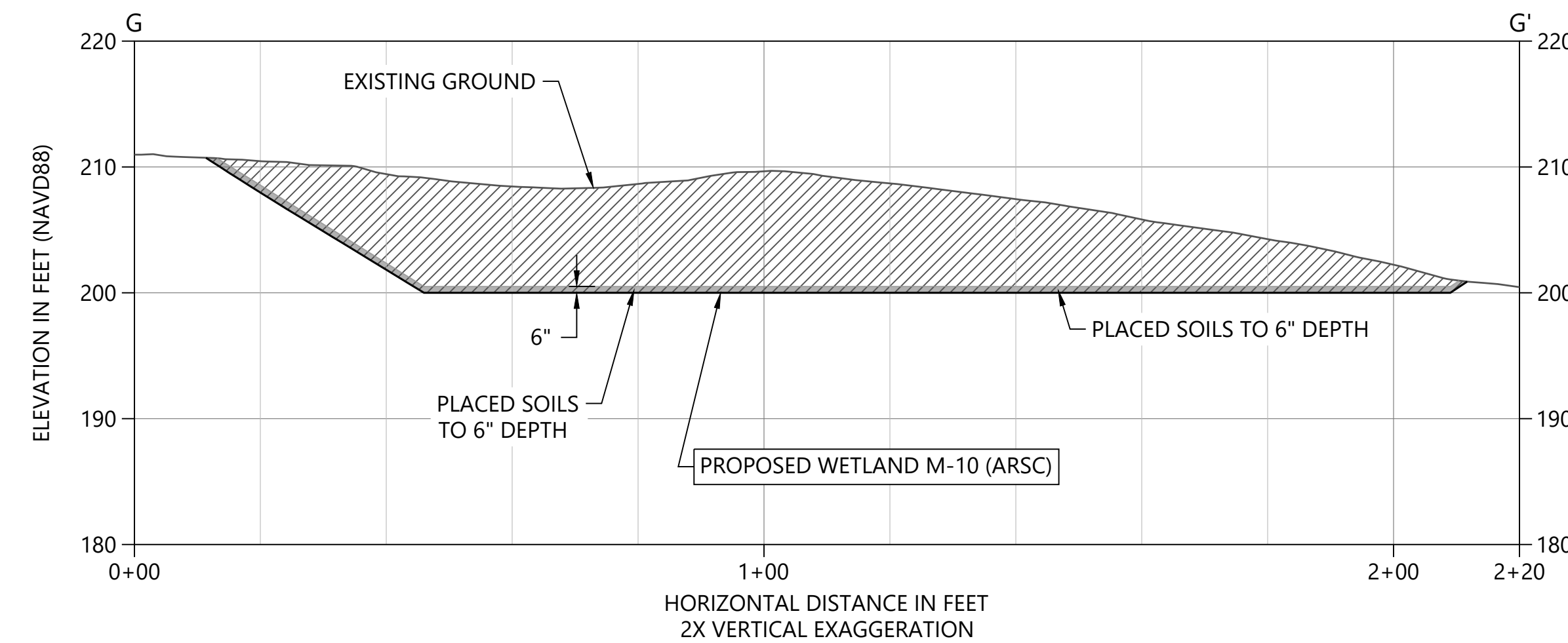
D SECTION
SCALE: 1" = 20'



E SECTION
SCALE: 1" = 20'



F SECTION
SCALE: 1" = 20'



G SECTION
SCALE: 1" = 20'

LEGEND:
 EXCAVATE EXISTING SOILS AND BEDROCK
 PLACED SOILS

PLAN INTENDED TO BE VIEWED
IN COLOR. ADJACENT BLOCK IS
"BLUE"
ONE INCH
AT FULL SIZE. IF NOT ONE
INCH SCALE ACCORDINGLY

PERMIT-NOT FOR CONSTRUCTION



REVISIONS				
REV	DATE	BY	APP'D	DESCRIPTION

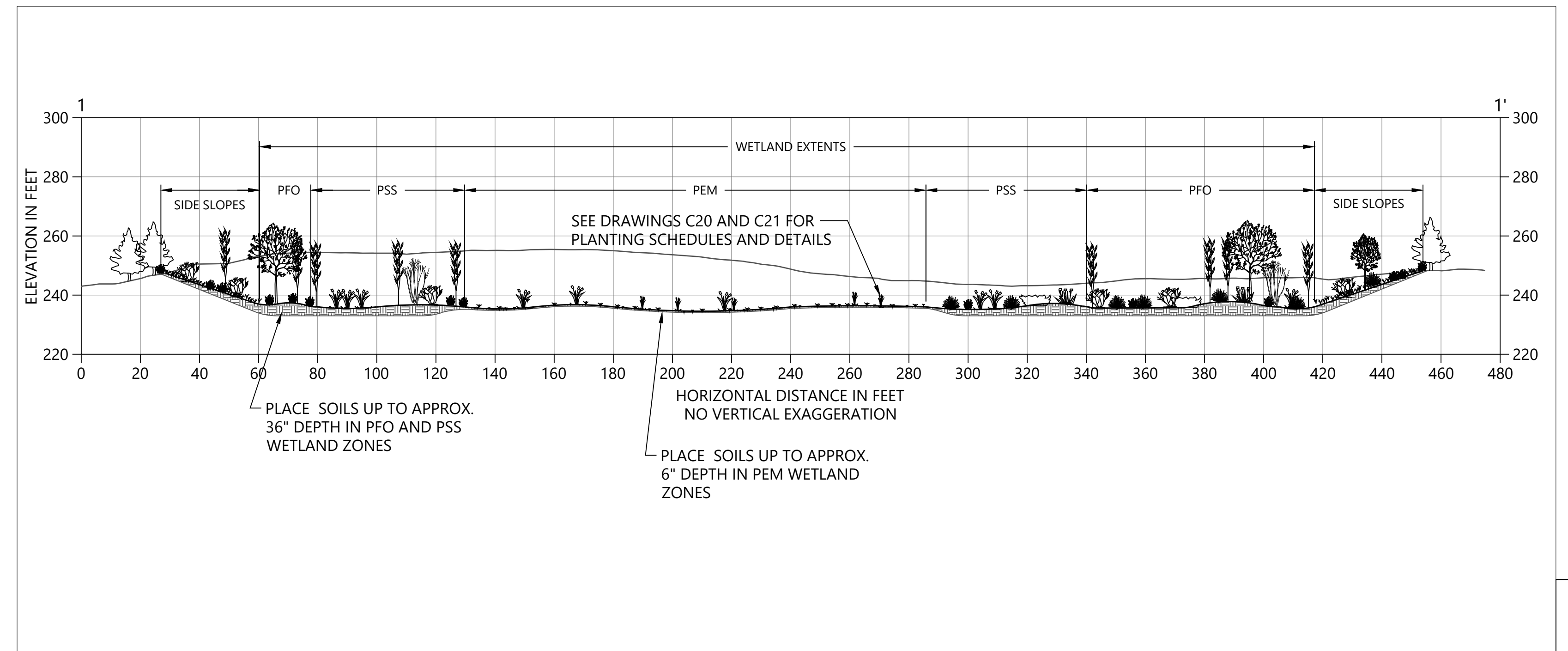
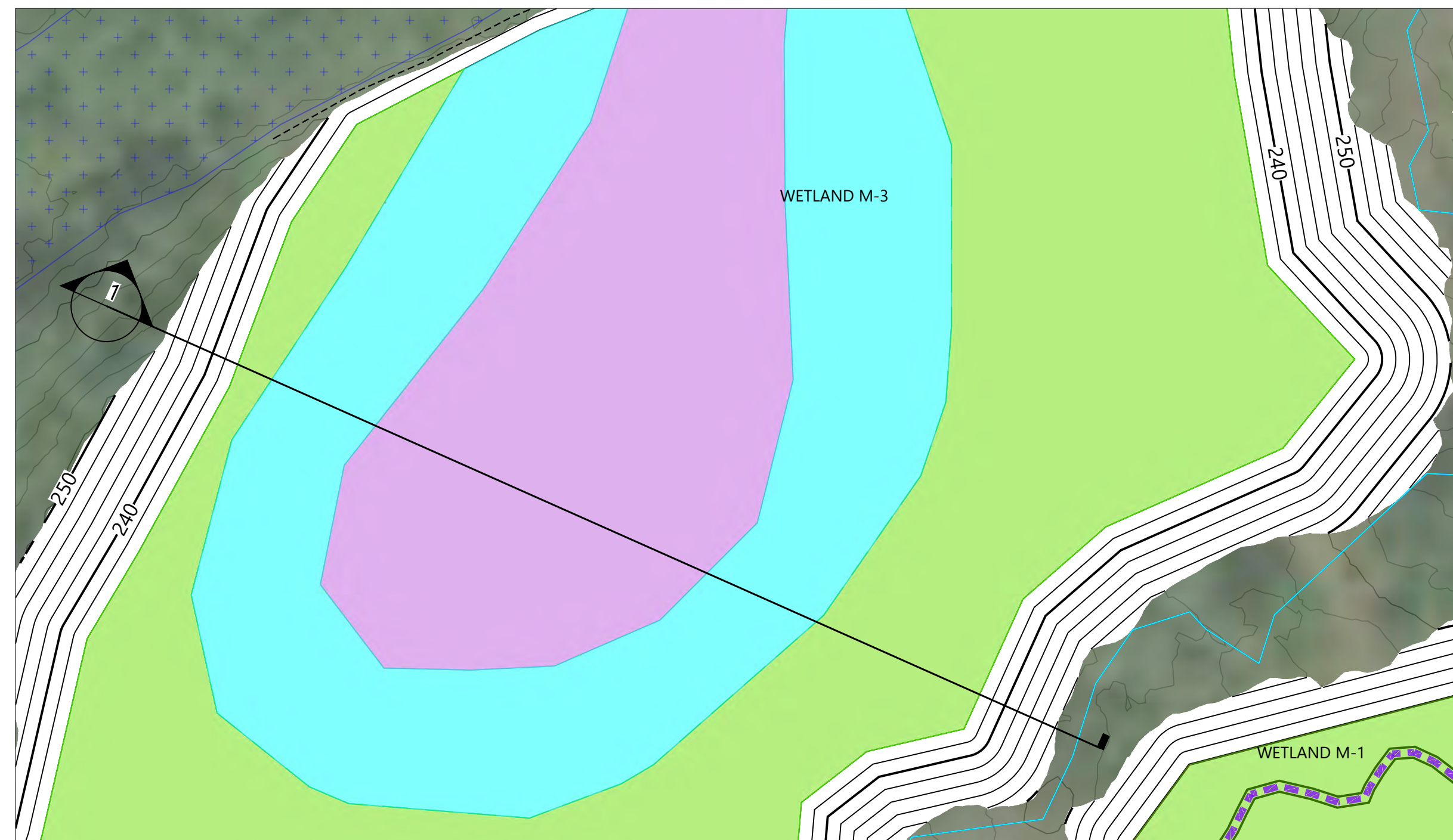
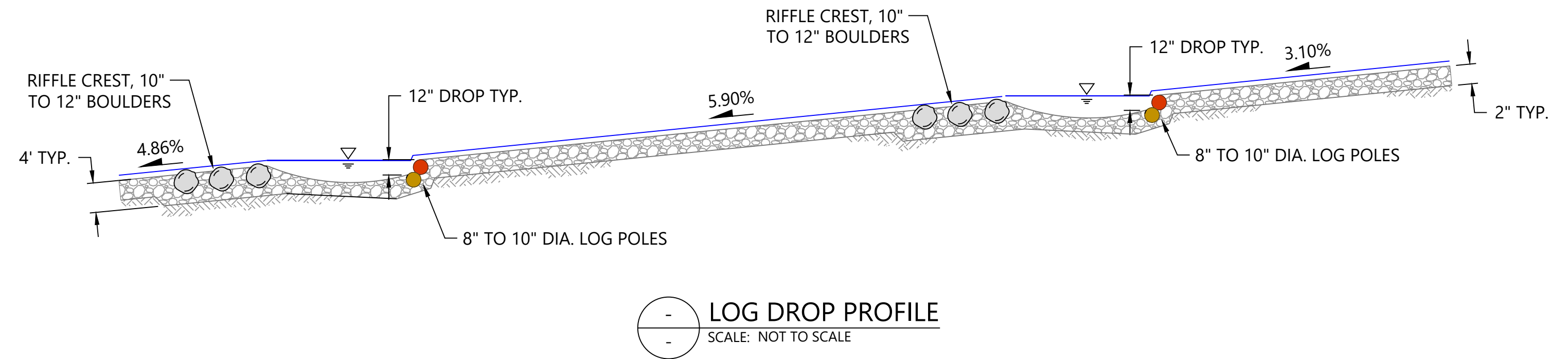
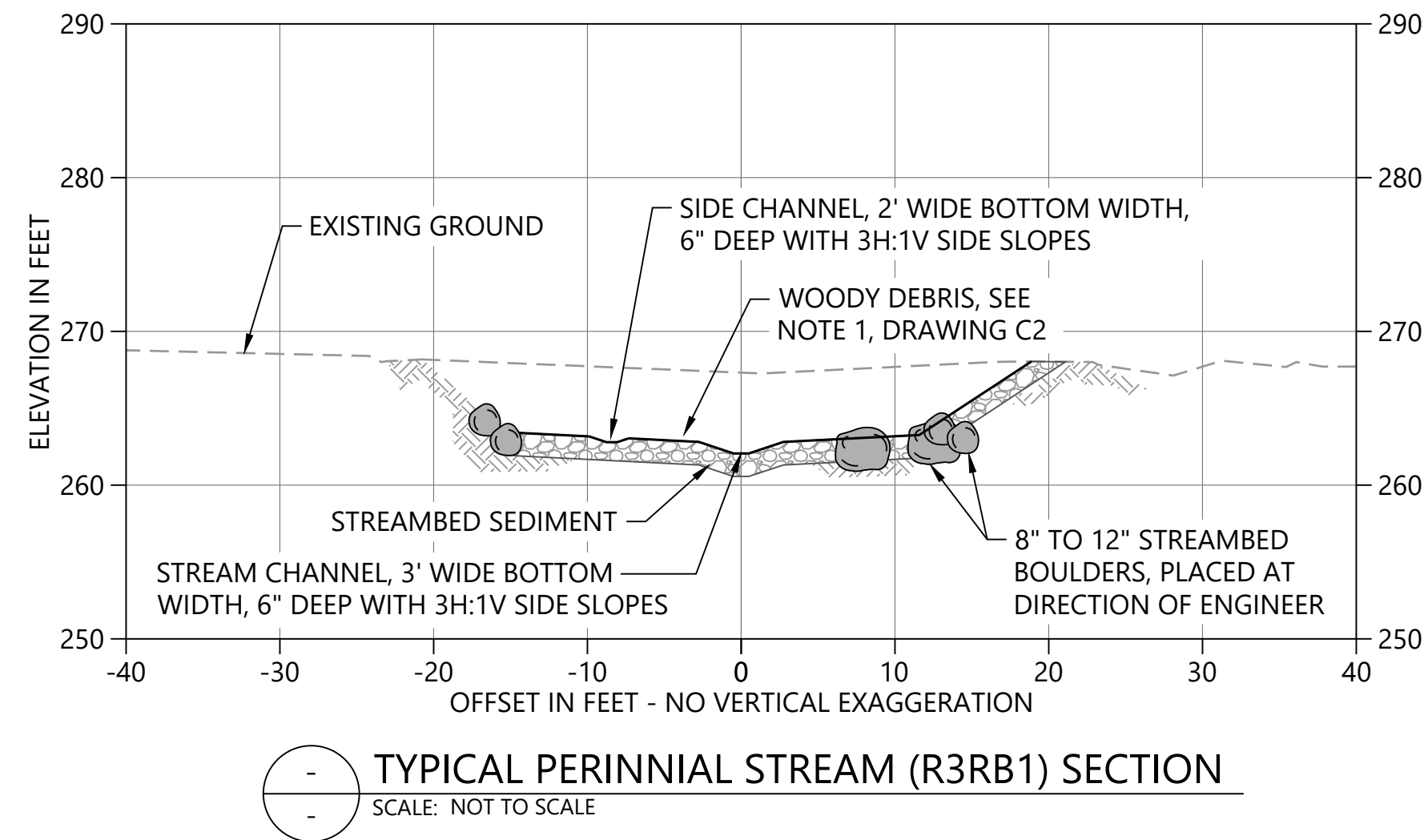
DESIGNED BY: J. FOX
 DRAWN BY: D. HOLMER
 CHECKED BY: J. FOX
 APPROVED BY: G. SUMMERS
 SCALE: AS NOTED
 DATE: OCTOBER 2023

WATERS QUARRY PHASE II PROJECT
 KNIFE RIVER CORPORATION
**CROSS SECTIONS THROUGH WETLAND
 PREPARATION GRADING AREAS (SHEET 2 OF 2)**

C13

SHEET # 16 OF 22

K:\Projects\2114-Knife River Corporation-NW\Waters Quarry Expansion\Construction Plans\2114-C-SERIES.dwg C13 Nov 30, 2023 12:58pm chawett



1 TYPICAL WETLAND AREA M-3 PLAN
SCALE: NOT TO SCALE

1 TYPICAL WETLAND AREA M-3 SECTION
SCALE: NOT TO SCALE

- LEGEND:**
- PEM WETLAND PLANTING AREA
 - PFO WETLAND PLANTING AREA
 - PSS WETLAND PLANTING AREA
 - ARSC WETLAND PLANTING AREA

- NOTES:**
1. PFO WETLAND AREA PLANTINGS SHALL INCLUDE TREES WITH AND UNDERSTORY OF SHRUBS, FORBS AND GRASSES.
 2. PSS WETLAND AREA PLANTINGS SHALL INCLUDE SHRUBS WITH AND UNDERSTORY OF FORBS AND GRASSES.
 3. PEM WETLAND AREA PLANTINGS WILL INCLUDE FORBS AND GRASSES ONLY.
 4. SEE PLANTING SCHEDULE AND DETAILS ON ON DRAWINGS C20 AND C21 FOR MORE INFORMATION.

PLAN INTENDED TO BE VIEWED IN COLOR. ADJACENT BLOCK IS "BLUE" INCH SCALE ACCORDINGLY

PERMIT-NOT FOR CONSTRUCTION



REVISIONS				
REV	DATE	BY	APP'D	DESCRIPTION

DESIGNED BY: J. FOX
 DRAWN BY: D. HOLMER
 CHECKED BY: J. FOX
 APPROVED BY: G. SUMMERS
 SCALE: AS NOTED
 DATE: OCTOBER 2023

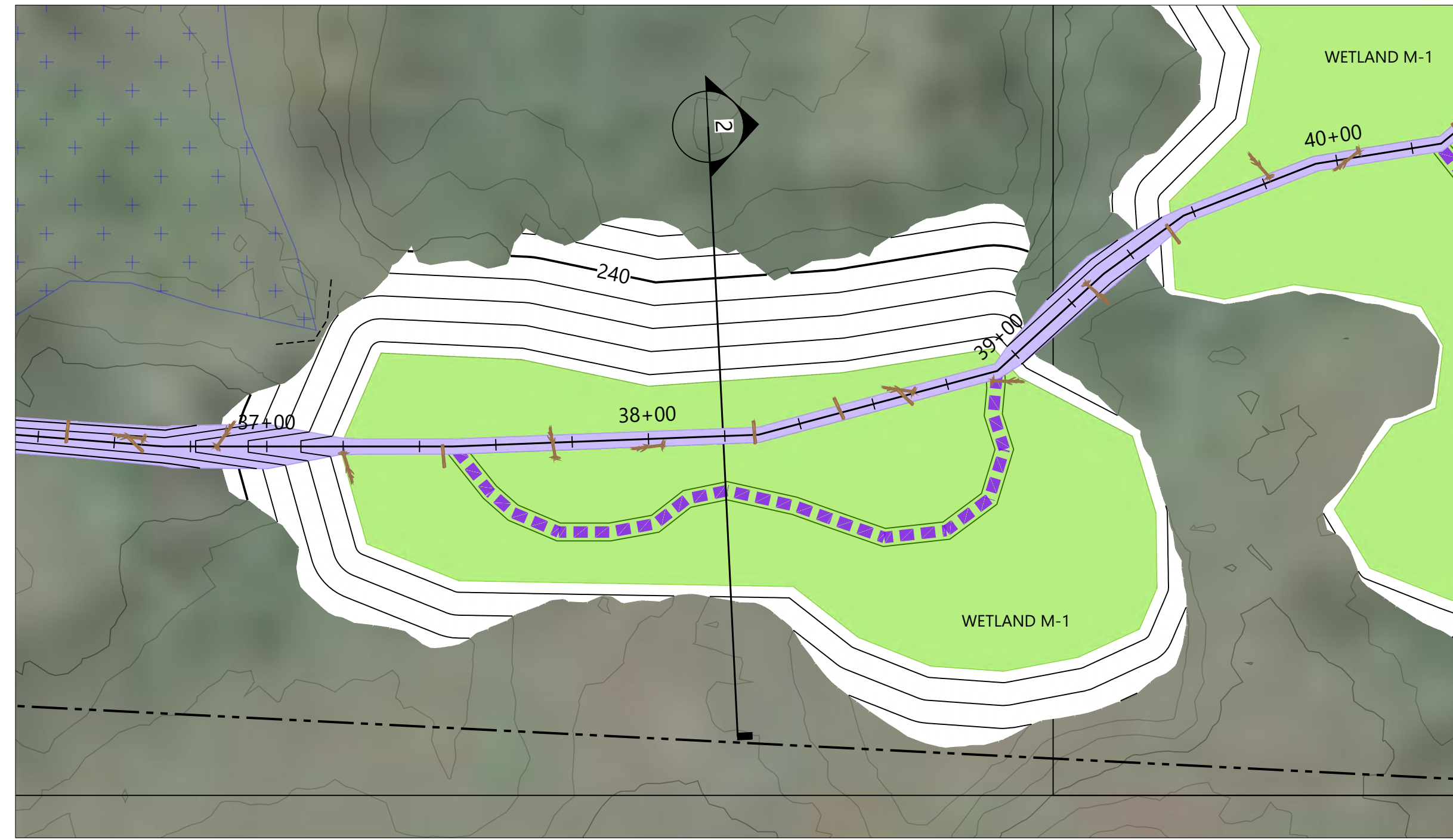
WATERS QUARRY PHASE II PROJECT
KNIFE RIVER CORPORATION

PLANTING AREA DETAILS (SHEET 1 OF 2)

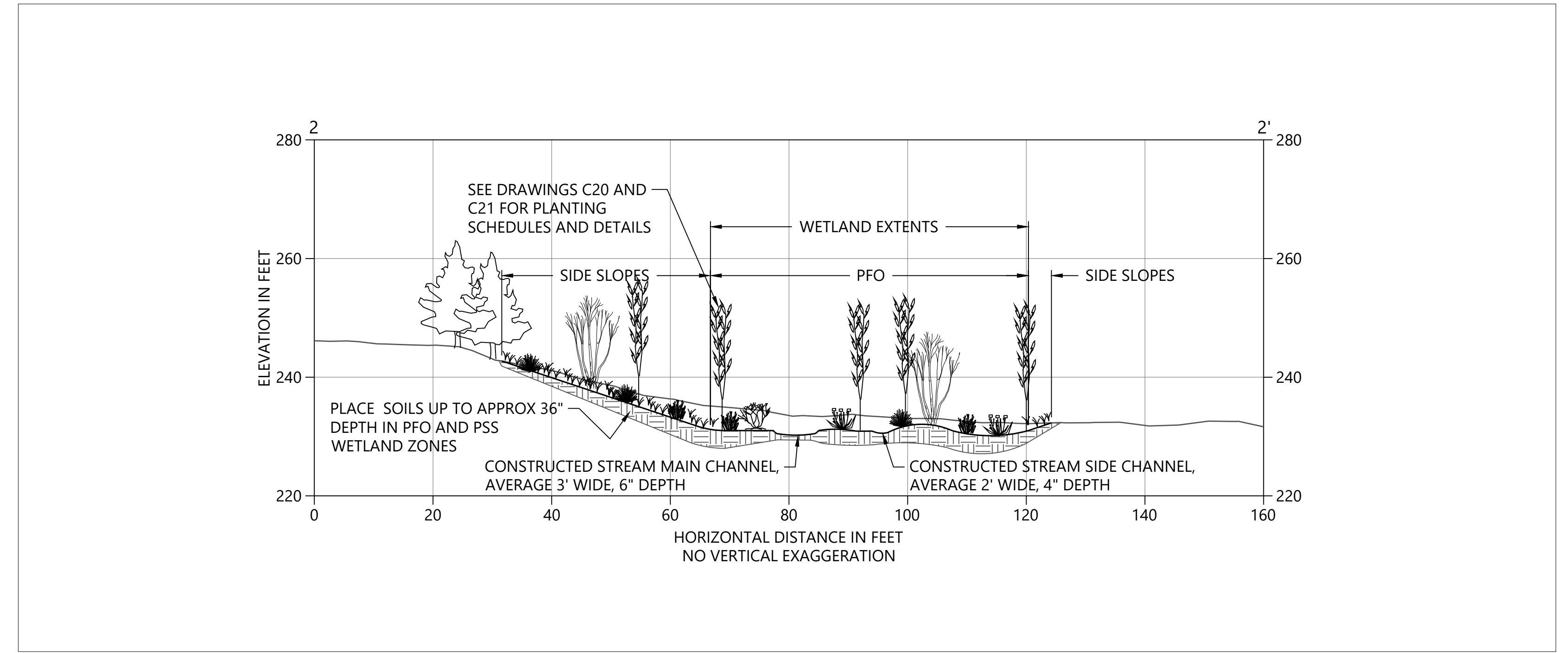
C14

SHEET # 17 OF 21

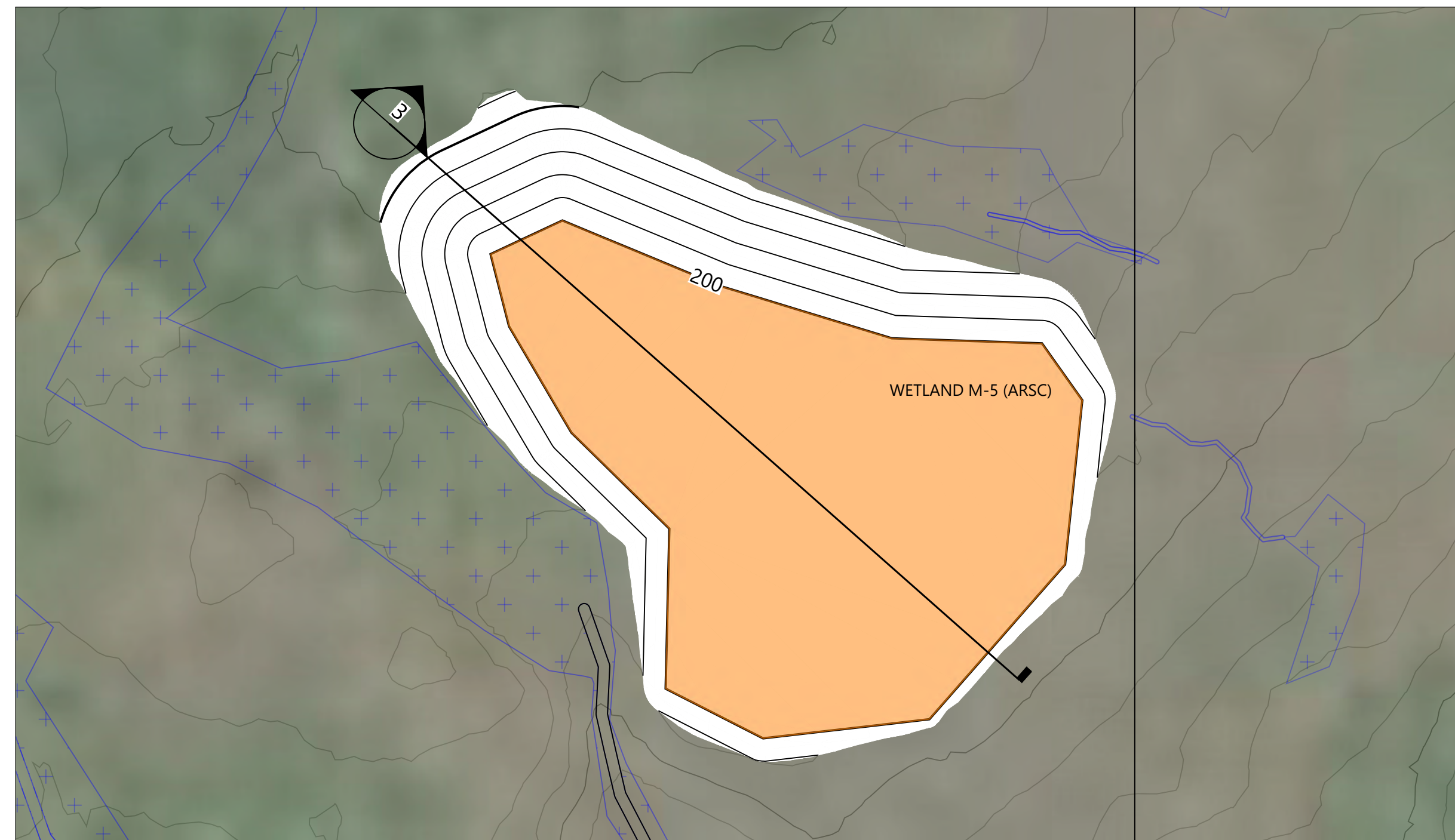
K:\Projects\32114-Knife River Corporation-NWA\Waters Quarry Expansion\Construction Plans\2114-C-SERIES.dwg C14 Nov 30, 2023 12:59pm chawett



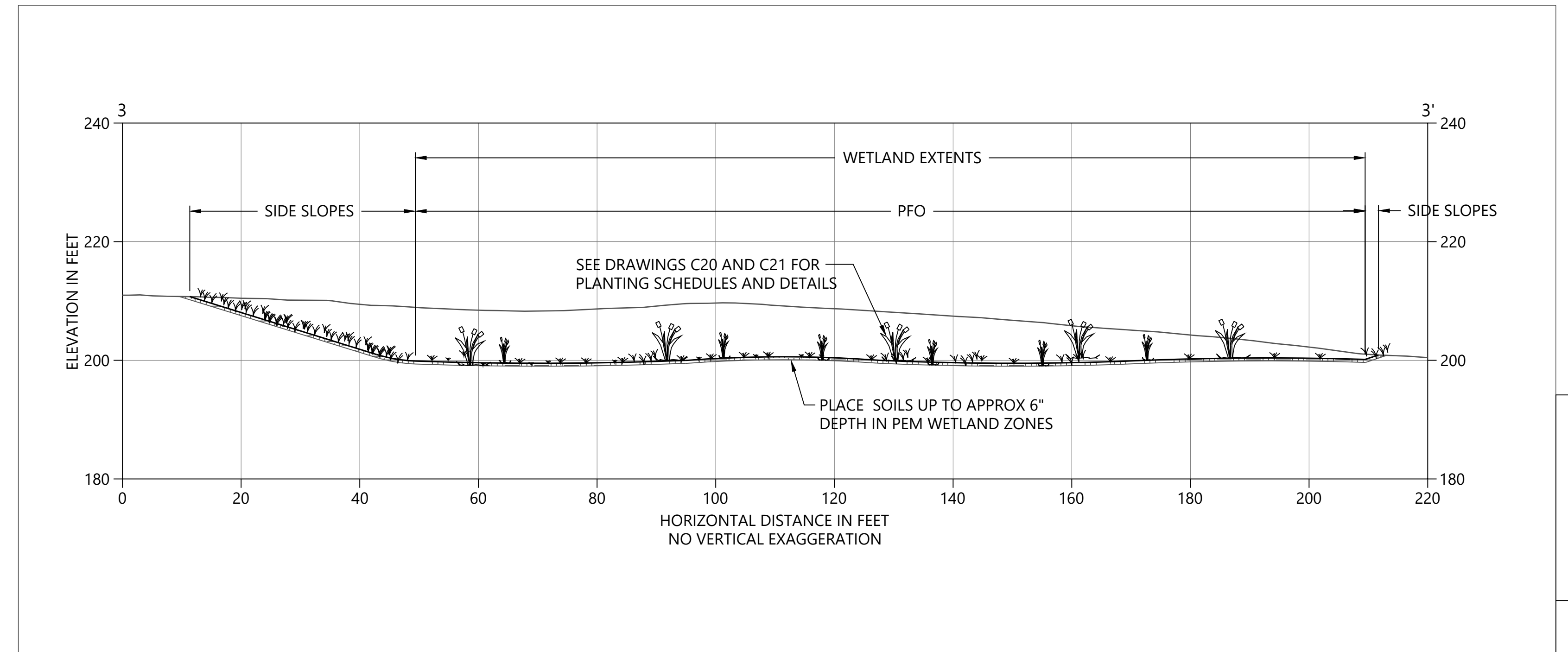
2 TYPICAL WETLAND AREA M-1 PLAN
SCALE: 1" = 30'



2 TYPICAL WETLAND AREA M-1 SECTION
SCALE: 1" = 15'



3 TYPICAL WETLAND AREA M-5 PLAN
SCALE: 1" = 30'



3 TYPICAL WETLAND AREA M-5 SECTION
SCALE: 1" = 15'

NOTE: SEE LEGEND AND NOTES ON DRAWING C18

PLAN INTENDED TO BE VIEWED IN COLOR. ADJACENT BLOCK IS "BLUE" INCH SCALE ACCORDINGLY

K:\Projects\3114-Knife River Corporation-NW\Waters Quarry Expansion\Construction Plans\3114-C-SERIES.dwg C15

Nov 30, 2023 1:00pm chervett



REVISIONS				
REV	DATE	BY	APP'D	DESCRIPTION

DESIGNED BY: J. FOX
 DRAWN BY: D. HOLMER
 CHECKED BY: J. FOX
 APPROVED BY: G. SUMMERS
 SCALE: AS NOTED
 DATE: OCTOBER 2023

WATERS QUARRY PHASE II PROJECT
KNIFE RIVER CORPORATION

PLANTING AREA DETAILS (SHEET 2 OF 2)

C15

SHEET # 20 OF 22

PERMIT-NOT FOR CONSTRUCTION

TABLE 13 NATIVE WOODY SPECIES PLANTINGS FOR FORESTED AND SCRUB-SHRUB WETLANDS			
SPECIES	INDICATOR STATUS	ON CENTER SPACING (FEET)	PLANT NUMBERS
FORESTED AND SCRUB-SHRUB PORTIONS OF WETLANDS M-1, M-2, AND M-3			
TREES (0.01 PER SQUARE FOOT)			
Black cottonwood (<i>Populus balsamifera</i> ssp. <i>Trichocarpa</i>)	FAC	7	1,871
Oregon ash (<i>Fraxinus latifolia</i>)	FACW	7	1,871
Pacific willow (<i>Salix lasiandra</i>)	FACW	7	1,122
Red alder (<i>Alnus rubra</i>)	FAC	7	1,123
Sitka spruce (<i>Picea sitchensis</i>)	FAC	7	749.0000
Western red cedar (<i>Thuja plicata</i>)	FAC	7	749.0000
TREE SUBTOTAL			7,485
SHRUBS (0.05 PER SQUARE FOOT)			
Black hawthorn (<i>Crataegus douglasii</i>)	FAC	4	4,491
Bunchberry dogwood (<i>Cornus canadensis</i>)	FAC	4	4,491
Cluster rose (<i>Rosa pisocarpa</i>)	FAC	4	3,368
Douglas spirea (<i>Spiraea douglasii</i>)	FACW	4	3,743
Oregon crab apple (<i>Malus fusca</i>)	FACW	4	4,491
Pacific ninebark (<i>Physocarpus capitatus</i>)	FACW	4	3,743
Red osier dogwood (<i>Cornus stolonifera</i>)	FACW	4	3,743
Sitka willow (<i>Salix sitchensis</i>)	FACW	4	4,491
Twinberry honeysuckle (<i>Lonicera involucrata</i>)	FAC	4	4,866
SHRUB SUBTOTAL			37,427
TOTAL PLANTS			44,912
NOTES:			
FAC: facultative			
FACW: facultative wetland			

TABLE 14 NATIVE HERBACEOUS SPECIES PLANTINGS FOR EMERGENT AND WET ROCK OUTCROP (ARSC) WETLANDS			
SPECIES	INDICATOR STATUS	FORM	
		BARE ROOT, PLUG, CONTAINER	SEED
EMERGENT PORTIONS OF WETLANDS M-1, M-2, AND M-3			
GRAMINOIDS AND FORBS			
American sloughgrass (<i>Beckmannia syzigachne</i>)	OBL		X
Big leaf lupine (<i>Lupinus polyphyllus</i>)	FAC	X	X
Dagger-leaf rush (<i>Juncus ensifolius</i>)	FACW	X	X
Darkthroat shootingstar (<i>Dodecatheon pulchellum</i>)	FACW	X	X
Devil's beggartick (<i>Bidens frondosa</i>)	FACW		X
Hardstem bulrush (<i>Schoenoplectus acutus</i>)	OBL	X	
Needle spike rush (<i>Eleocharis acicularis</i>)	OBL		X
Oregon saxifrage (<i>Micranthes oregana</i>)	FACW	X	X
Red columbine (<i>Aquilegia formosa</i>)	FAC		X
Saw-beaked sedge (<i>Carex stipata</i>)	OBL	X	X
Slough sedge (<i>Carex obnupta</i>)	OBL	X	X
Small-fruited bulrush (<i>Scirpus microcarpus</i>)	OBL	X	X
Soft-stem bulrush (<i>Schoenoplectus tabernaemontani</i>)	OBL	X	X
Stream violet (<i>Viola glabella</i>)	FACW		X
Wet Rock Outcrop (ARSC Wetlands M-4, M-5, M-6, and M-7)			
GRAMINOIDS AND FORBS			
California oatgrass (<i>Danthonia californica</i>)	FAC		X
Common camas (<i>Camassia quamash</i>)	FACW	X	X
Creeping spike rush (<i>Eleocharis palustris</i>)	OBL	X	X
Dense sedge (<i>Carex densa</i>)	OBL	X	X
Fool's onion (<i>Triteleia hyacinthina</i>)	FAC	X	X
Fragrant popcorn flower (<i>Plagiobothrys figuratus</i>)	FACW		X
Great camas (<i>Camassia leichtlinii</i>)	FACW	X	X
Meadow popcorn flower (<i>Plagiobothrys scouleri</i>)	FACW		X
Meadow barley (<i>Hordeum brachyantherum</i>)	FACW		X
Nuttall's quillwort (<i>Isoetes nuttallii</i>)	OBL		X
Seep monkeyflower (<i>Mimulus guttatus</i>)	OBL	X	X
Tufted hairgrass (<i>Deschampsia caespitosa</i>)	FACW		X
NOTES:			
FAC: facultative			
FACW: facultative wetland			
OBL: obligate wetland			

TABLE 15 WOODY NATIVE SPECIES PLANTINGS FOR RIPARIAN AREAS			
SPECIES	INDICATOR STATUS	ON CENTER SPACING (FEET)	PLANT NUMBERS
RIPARIAN AND PERENNIAL STREAMSIDE HABITATS (PERENNIAL STREAM MS-1)			
TREES (0.01 PER SQUARE FOOT)			
Big leaf maple (<i>Acer macrophyllum</i>)	FACU	7	1,609
Bitter Cherry (<i>Prunus emarginata</i>)	FACU	7	2,682
Cascara buckthorn (<i>Rhamnus purshiana</i>)	FAC	7	1,341
Grand fir (<i>Abies grandis</i>)	FACU	7	2,682
Oregon white oak (<i>Quercus garryana</i>)	FAC	7	2,012
Willamette Valley ponderosa pine (<i>Pinus ponderosa</i> var. <i>benthamiana</i>)	FAC	7	3,085
TREE SUBTOTAL			13,411
SHRUBS (0.05 PER SQUARE FOOT)			
Cascade Oregon-Grape (<i>Mahonia nervosa</i>)	FACU	4	5,364
Common snowberry (<i>Symphoricarpos albus</i>)	FACU	4	8,717
Indian plum (<i>Oemleria cerasiformis</i>)	FACU	4	8,047
Nootka Rose (<i>Rosa nutkana</i>)	FAC	4	7,376
Oceanspray (<i>Holodiscus discolor</i>)	FACU	4	8,047
Red elderberry (<i>Sambucus racemosa</i>)	FACU	4	8,717
Red flowering currant (<i>Ribes sanguineum</i>)	FACU	4	5,364
Saskatoon serviceberry (<i>Amelanchier alnifolia</i>)	FACU	4	6,707
SHRUB SUBTOTAL			67,056
TOTAL PLANTS			80,467
NOTES:			
FAC: facultative			
FACU: facultative upland			

K:\Projects\2114-Knife River Corporation-NW\Waters Quarry Expansion\Construction Plans\2114-C-SERIES.dwg C16

ONE INCH
↑
↓
AT FULL SIZE. IF NOT ONE INCH SCALE ACCORDINGLY

PLAN INTENDED TO BE VIEWED IN COLOR. ADJACENT BLOCK IS "BLUE"

PERMIT-NOT FOR CONSTRUCTION



REVISIONS				
REV	DATE	BY	APP'D	DESCRIPTION

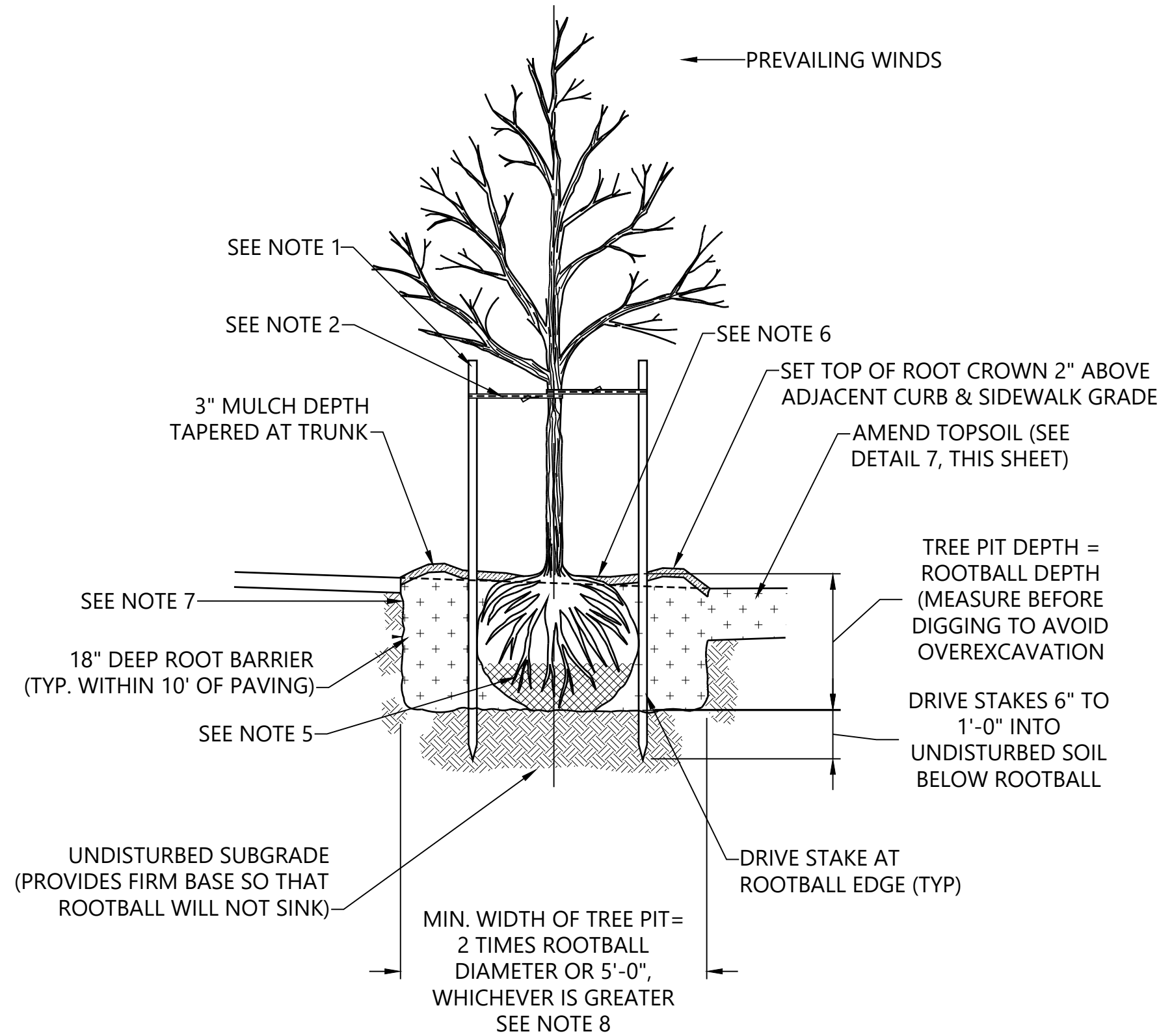
DESIGNED BY: J. FOX
 DRAWN BY: D. HOLMER
 CHECKED BY: J. FOX
 APPROVED BY: G. SUMMERS
 SCALE: AS NOTED
 DATE: OCTOBER 2023

WATERS QUARRY PHASE II PROJECT
KNIFE RIVER CORPORATION

PLANTING SCHEDULE

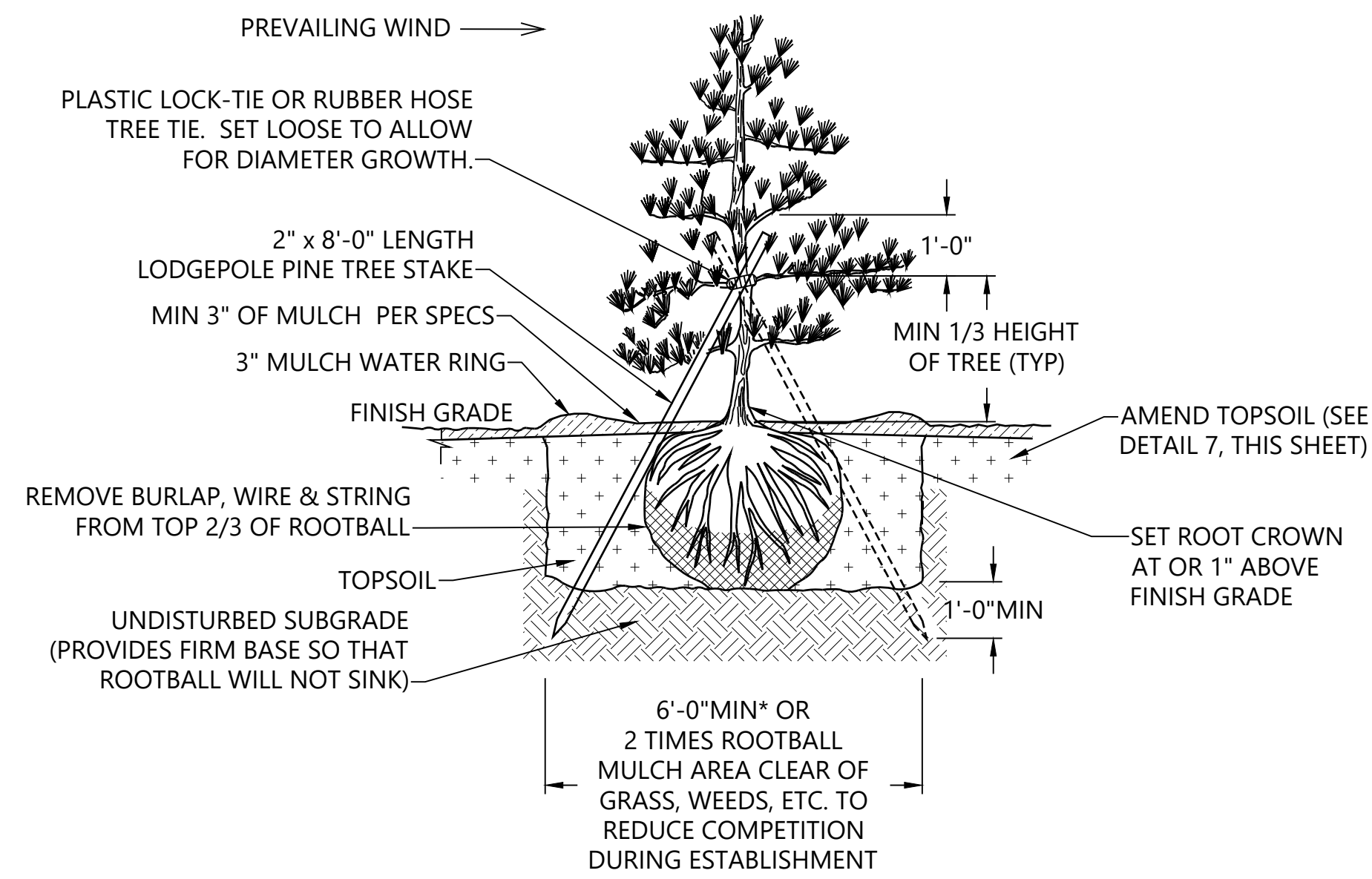
C16

SHEET # **20** OF **22**

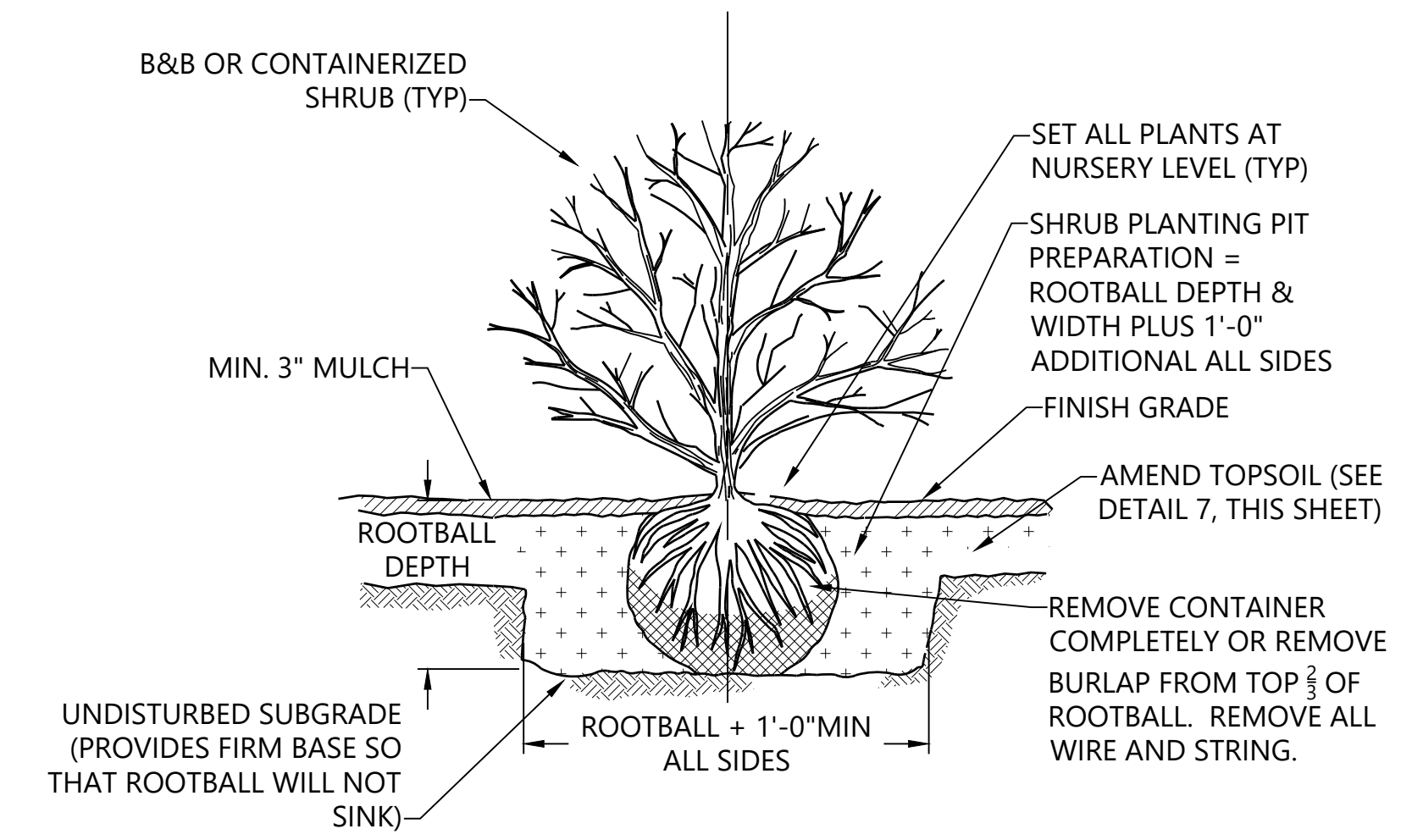


- NOTES:**
1. STAKE TREES WITH (2) 2" DIAMETER (8'-0" LENGTH) LODGE POLE PINE OR DOUGLAS FIR STAKES
 2. CHAINLOCK TREE TIE. LOOP EACH TIE AROUND TREE LOOSELY TO PROVIDE 1" SLACK FOR DIAMETER GROWTH.
 3. ONE STAKE PER TREE ON WINDWARD SIDE;
 4. SECOND STAKE ON LEEWARD SIDE
 5. REMOVE ALL WIRE AND STRING. REMOVE TOP 2/3 OF BURLAP
 6. SHAPE SOIL TO PROVIDE 3' DIAMETER OR ROOTBALL DIAMETER, WHICHEVER IS GREATER, WATERING RING.
 7. ROUGHEN SIDES OF PLANTING HOLE MAXIMIZE EXCAVATED AREA WITHOUT UNDERMINING ADJACENT PAVING/CURB
 8. MULCH AREA TO BE CLEAR OF GRASS, WEEDS, ETC. TO REDUCE COMPETITION WITH TREE ROOTS

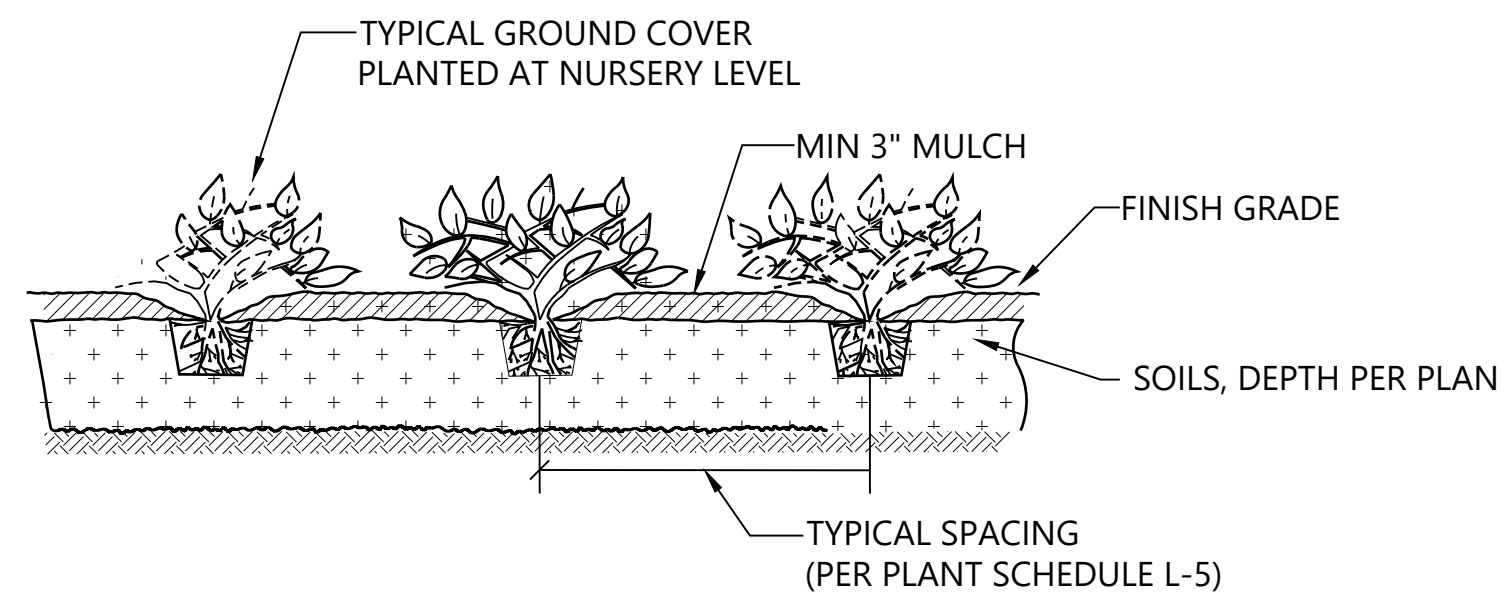
1 DECIDUOUS TREE PLANTING & STAKING
SCALE: NOT TO SCALE



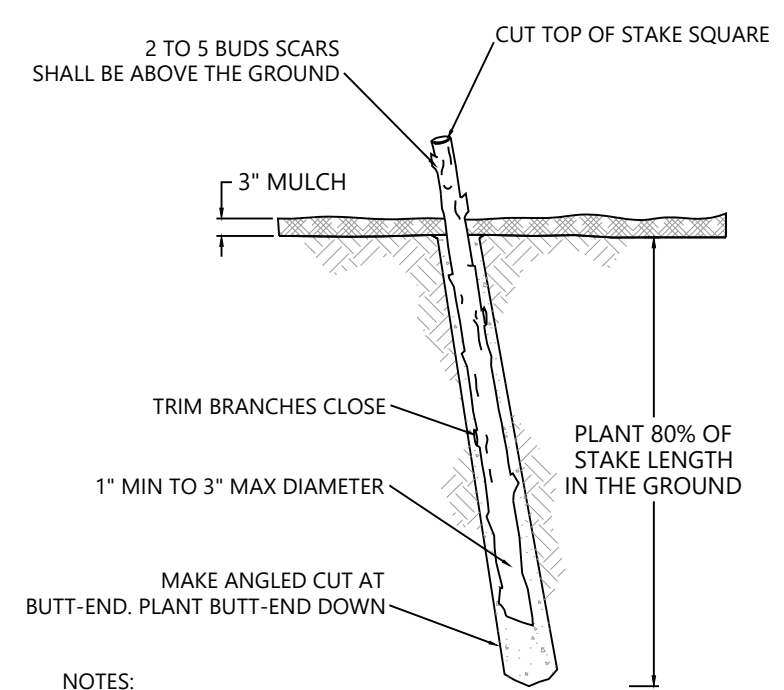
2 CONIFEROUS TREE PLANTING & STAKING
SCALE: NOT TO SCALE



3 SHRUB PLANTING
SCALE: NOT TO SCALE

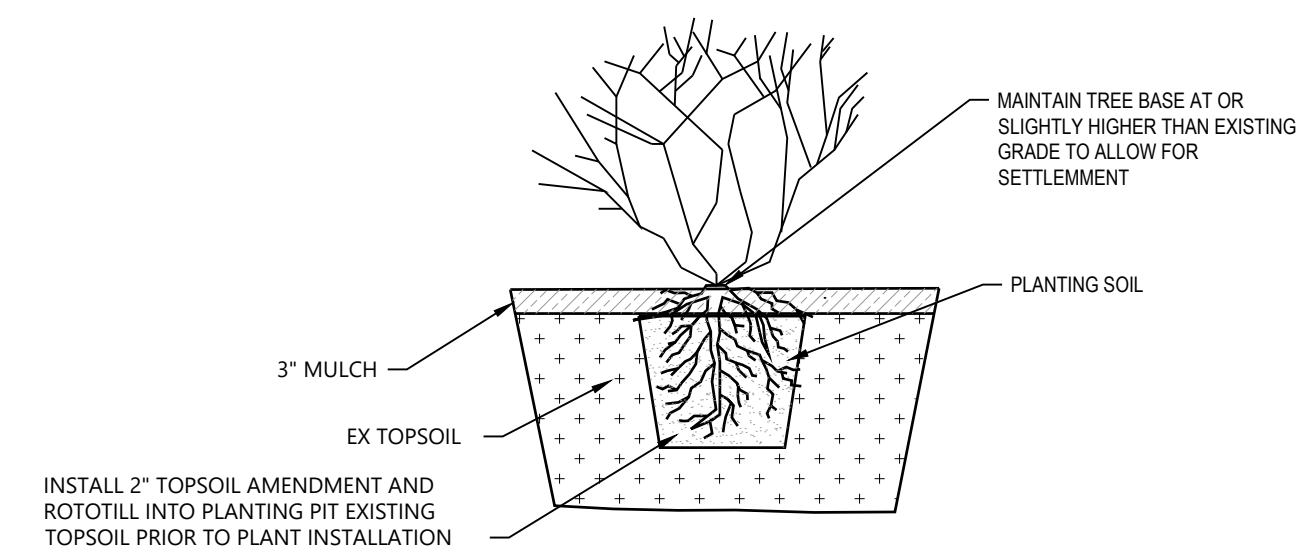


4 GROUNDCOVER, PERENNIAL, AND ORNAMENTAL GRASS PLANTING
SCALE: NOT TO SCALE

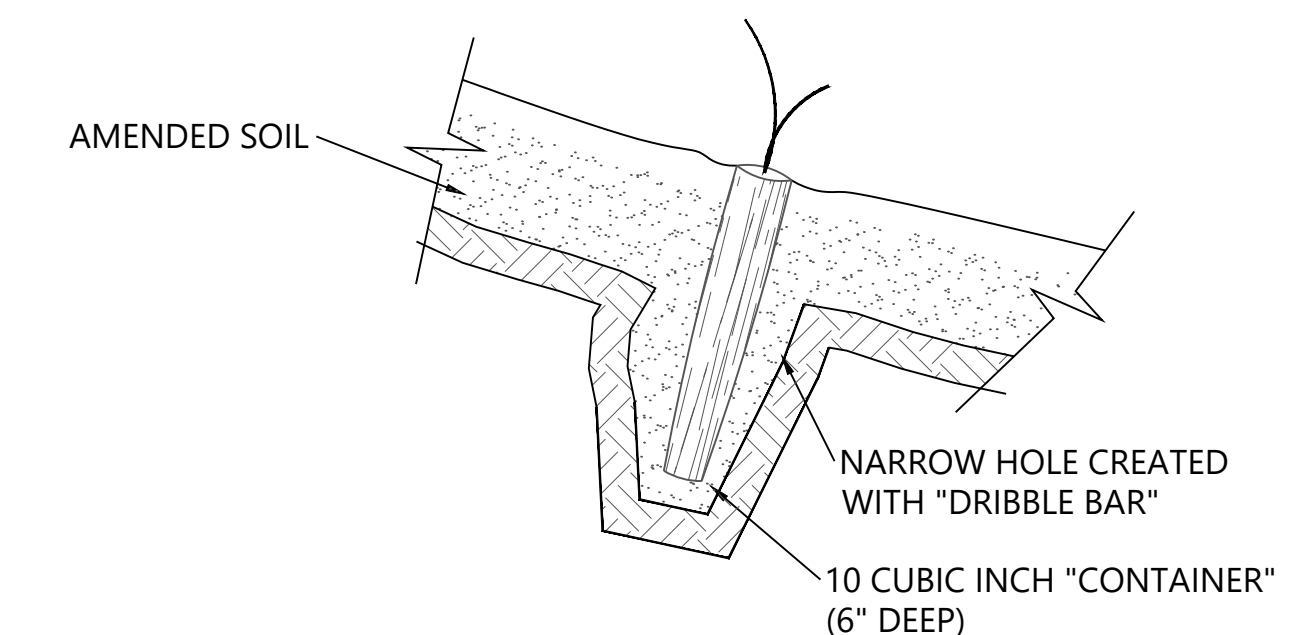


- NOTES:**
1. HARVEST AND PLANT STAKES DURING THE DORMANT SEASON.
 2. MAKE CLEAN CUTS AND DO NOT DAMAGE STAKES OR SPLIT ENDS DURING INSTALLATION. USE A PILOT BAR IN FIRM SOILS.
 3. SOAK CUTTINGS CONTINUOUSLY PRIOR TO INSTALLATION.
 4. TAMP THE SOIL AROUND THE STAKE.
 5. ONLY NURSERY GROWN STOCK SHALL BE USED. HARVESTING OF WILD PLANTS IS NOT ACCEPTABLE.

5 LIVESTAKE PLANTING
SCALE: NOT TO SCALE



6 BARE ROOT PLANTING
SCALE: NOT TO SCALE



7 PLUG PLANTING
SCALE: NOT TO SCALE

PLAN INTENDED TO BE VIEWED IN COLOR. ADJACENT BLOCK IS "BLUE"
ONE INCH AT FULL SIZE. IF NOT ONE INCH SCALE ACCORDINGLY

PERMIT-NOT FOR CONSTRUCTION

K:\Projects\3114-Knife River Corporation-NW\Waters Quarry Expansion\Construction\Plans\3114-C-SERIES.dwg C17 Nov 30, 2023 1:00pm chenvett



REVISIONS				
REV	DATE	BY	APP'D	DESCRIPTION

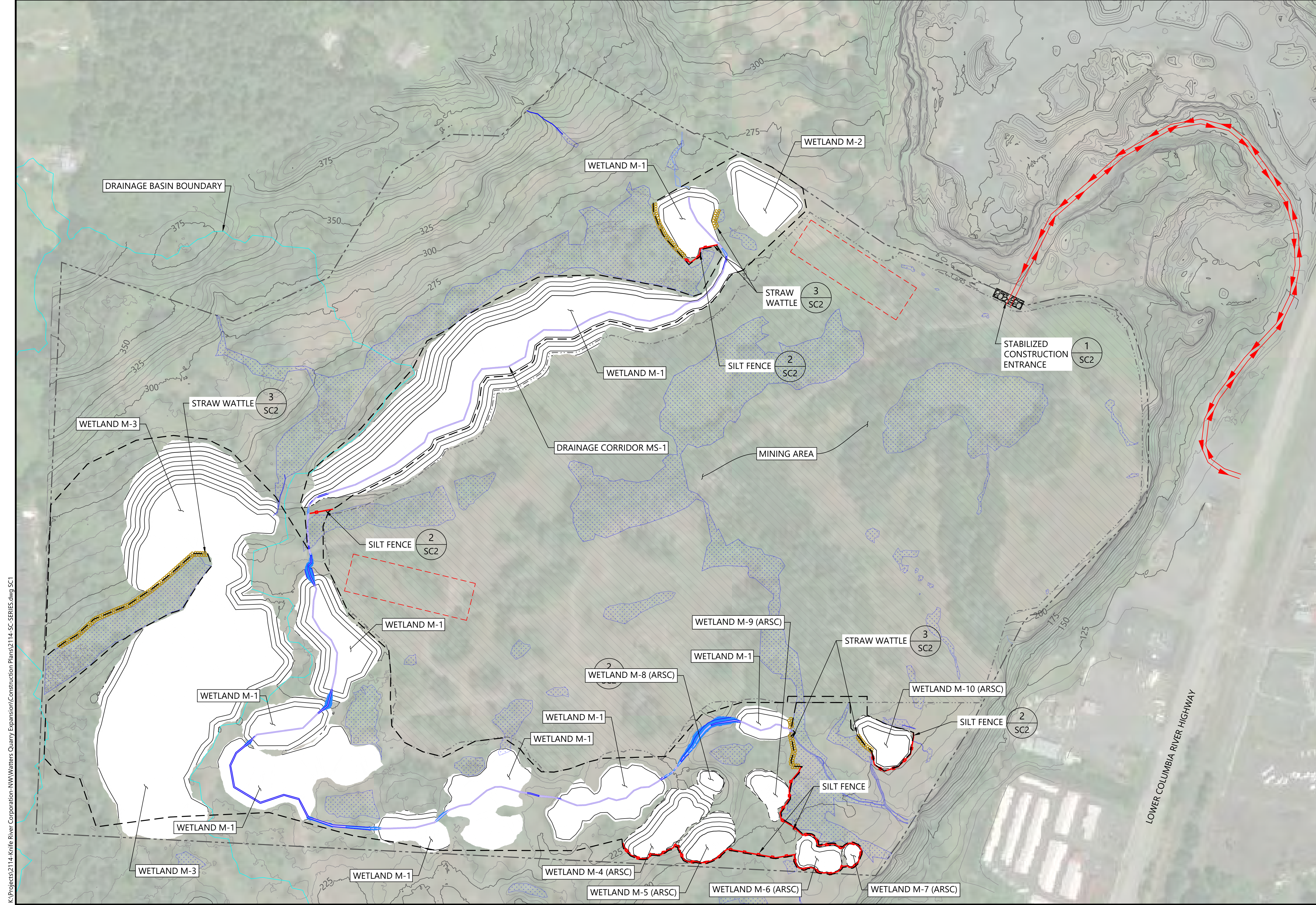
DESIGNED BY: J. FOX
 DRAWN BY: D. HOLMER
 CHECKED BY: J. FOX
 APPROVED BY: G. SUMMERS
 SCALE: AS NOTED
 DATE: OCTOBER 2023

WATERS QUARRY PHASE II PROJECT
KNIFE RIVER CORPORATION

PLANTING DETAILS

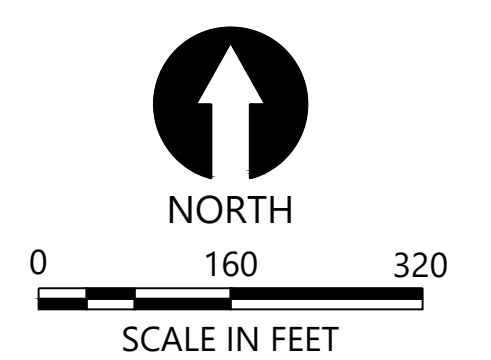
C17

SHEET # **20** OF **22**



- LEGEND:**
- EXISTING TOPOGRAPHY (5' INTERVAL)
 - PRELIMINARY QUARRY EXCAVATION CONTOURS (5' INTERVAL)
 - - - PROJECT SITE
 - DELINEATED WETLAND AND STREAM BOUNDARIES
 - - - MINING BOUNDARY
 - STRAW WATTLES
 - SILT FENCE
 - - - CLEARING LIMITS
 - ACCESS ROUTE AND DIRECTION
 - STAGING AREA
- COWARDIN CLASSIFICATIONS:**
- PERENNIAL STREAM MS-1
 - PEM
 - PFO/PSS/PEM

- NOTES:**
1. SILT FENCE COLOR ALONG CLEARING LIMITS SHALL BE ORANGE.
 2. SILT FENCE AND OTHER SEDIMENT CONTROLS SHALL BE RELOCATED, AS NEEDED, TO ACCOMMODATE DIFFERENT PHASES OF CONSTRUCTION.
 3. SEE ADDITIONAL TEMPORARY EROSION AND SEDIMENTATION CONTROL NOTES ON DRAWING SC2.
 4. HORIZONTAL DATUM: OREGON STATE PLANE NORTH ZONE, NAD83, INTERNATIONAL FEET
 5. VERTICAL DATUM: NORTH AMERICAN VERTICAL DATUM OF 1988 (NAVD88)



SOURCE: AERIAL ©2020 MICROSOFT CORPORATION ©2020 DIGITALGLOBE ©CNES (2020) DISTRIBUTION AIRBUS DS

HORIZONTAL DATUM: OREGON STATE PLANE NORTH ZONE, NAD83, INTERNATIONAL FEET

VERTICAL DATUM: NORTH AMERICAN VERTICAL DATUM OF 1988 (NAVD88)

PERMIT-NOT FOR CONSTRUCTION

K:\Projects\3114-Knife River Corporation-NW\Waters Quarry Expansion\Construction Plans\3114-SC-SERIES.dwg SC1

Nov 30, 2023 1:01pm chevwtt



REVISIONS				
REV	DATE	BY	APP'D	DESCRIPTION

DESIGNED BY: J. FOX
 DRAWN BY: D. HOLMER
 CHECKED BY: J. FOX
 APPROVED BY: G. SUMMERS
 SCALE: AS NOTED
 DATE: OCTOBER 2023

WATERS QUARRY PHASE II PROJECT
KNIFE RIVER CORPORATION

TEMPORARY EROSION AND SEDIMENTATION CONTROL PLAN

SC1

SHEET # 21 OF 22

PLAN INTENDED TO BE VIEWED IN COLOR. ADJACENT BLOCK IS "BLUE" INCH SCALE ACCORDINGLY

GENERAL TEMPORARY EROSION AND SEDIMENT CONTROL (TESC) NOTES:

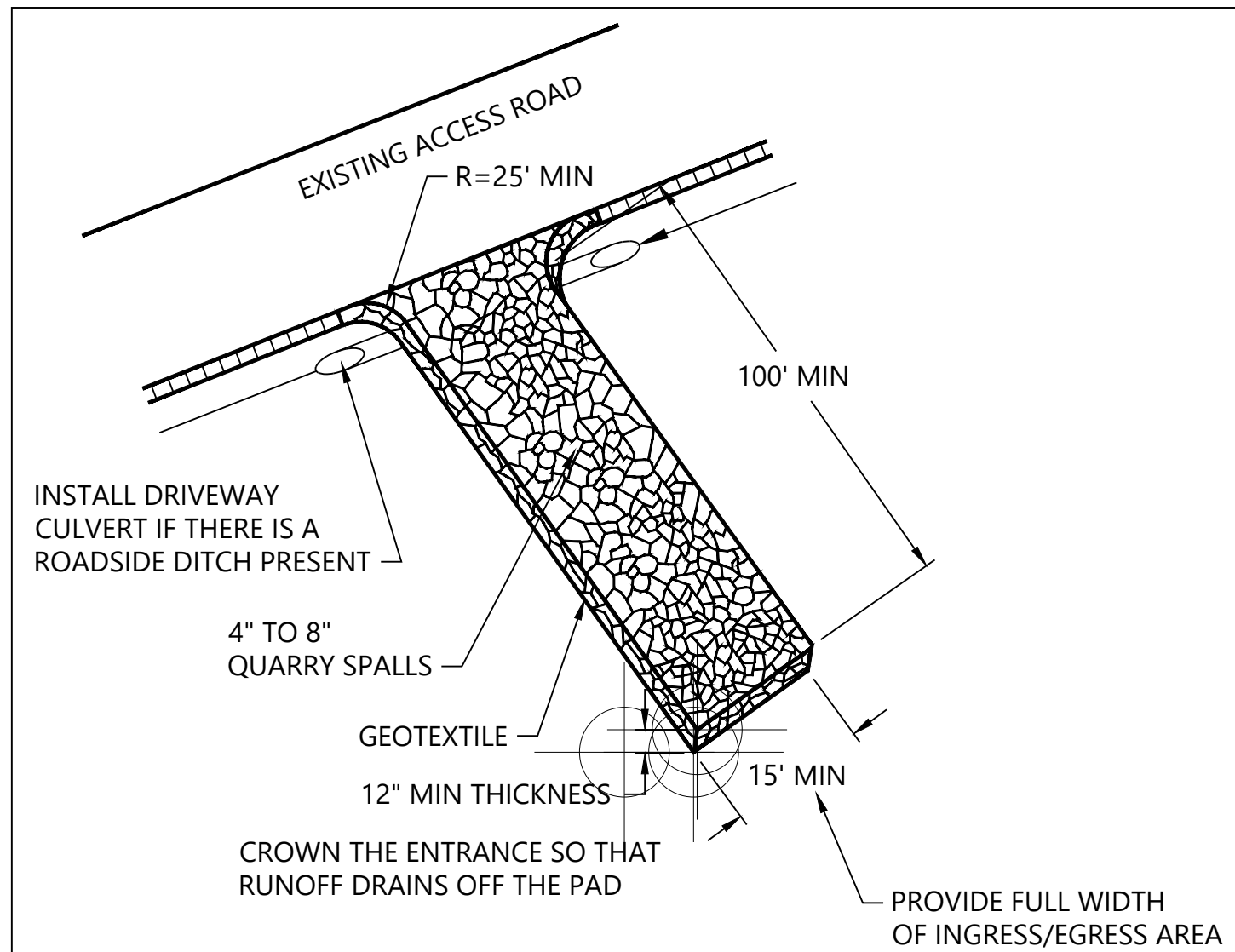
- THE CONTRACTOR SHALL PROVIDE A CERTIFIED EROSION AND SEDIMENT CONTROL MANAGER (ESCM) TO MANAGE AND MAINTAIN TEMPORARY EROSION AND SEDIMENT CONTROL FOR THE PROJECT. THE NAMED PERSON OR FIRM SHALL BE ON-SITE OR ON-CALL AT ALL TIMES.
- THE IMPLEMENTATION OF THESE TESC DRAWINGS AND THE CONSTRUCTION, MAINTENANCE, REPLACEMENT, AND UPGRADING OF THESE TESC FACILITIES IS THE RESPONSIBILITY OF THE CONTRACTOR UNTIL ALL CONSTRUCTION IS COMPLETED AND APPROVED AND VEGETATION/LANDSCAPING IS ESTABLISHED.
- THE CLEARING LIMIT BOUNDARIES SHALL BE CLEARLY FLAGGED IN THE FIELD PRIOR TO CONSTRUCTION. DURING THE CONSTRUCTION PERIOD, NO DISTURBANCE BEYOND THE FLAGGED CLEARING LIMITS SHALL BE PERMITTED. THE FLAGGING SHALL BE MAINTAINED BY THE CONTRACTOR FOR THE DURATION OF CONSTRUCTION.
- THE TESC FACILITIES SHOWN ON THESE DRAWINGS MUST BE CONSTRUCTED IN CONJUNCTION WITH ALL CLEARING AND GRADING ACTIVITIES, AND IN SUCH A MANNER AS TO ENSURE THAT SEDIMENT AND SEDIMENT-LADEN WATER DO NOT ENTER ANY DRAINAGE SYSTEMS, STREAMS, OR SURFACE WATER BODIES.
- THE TESC FACILITIES SHOWN ON THESE DRAWINGS ARE THE MINIMUM REQUIREMENTS FOR ANTICIPATED SITE CONDITIONS. DURING THE CONSTRUCTION PERIOD, THESE TESC FACILITIES SHALL BE UPGRADED AS NEEDED FOR UNEXPECTED STORM EVENTS AND TO ENSURE THAT SEDIMENT AND SEDIMENT-LADEN WATER DO NOT LEAVE THE SITE.
- THE TESC FACILITIES SHALL BE INSPECTED DAILY BY THE CONTRACTOR-AND MAINTAINED, REPAIRED, OR AUGMENTED AS NECESSARY, TO ENSURE THEIR CONTINUED FUNCTIONING.
- STABILIZED CONSTRUCTION ENTRANCES SHALL BE INSTALLED AT THE BEGINNING OF CONSTRUCTION AND MAINTAINED FOR THE DURATION OF THE PROJECT. ADDITIONAL MEASURES MAY BE REQUIRED TO ENSURE THAT ALL PAVED AREAS ARE KEPT CLEAN FOR THE DURATION OF THE PROJECT.
- FROM OCTOBER 1 THROUGH JUNE 30, NO SOILS SHALL REMAIN EXPOSED AND UNWORKED FOR MORE THAN 5 DAYS. FROM JULY 1 TO SEPTEMBER 30, NO SOILS SHALL REMAIN EXPOSED AND UNWORKED FOR MORE THAN 10 DAYS. SOILS SHALL BE STABILIZED AT THE END OF THE SHIFT BEFORE A HOLIDAY OR WEEKEND IF NEEDED BASED ON THE WEATHER FORECAST. THESE STABILIZATION REQUIREMENTS APPLY TO ALL SOILS ON SITE, WHETHER AT FINAL GRADE OR NOT. THE OWNER'S REPRESENTATIVE MAY ADJUST THESE TIME LIMITS IF IT CAN BE SHOWN THAT A DEVELOPMENT SITE'S EROSION OR RUNOFF POTENTIAL JUSTIFIES A DIFFERENT STANDARD.
- FROM OCTOBER 1 THROUGH JUNE 30, THE CONTRACTOR SHALL TAKE ADDITIONAL CARE TO CLEARLY DEMONSTRATE THAT CLEARING, GRADING, AND OTHER SOIL-DISTURBING ACTIVITIES WILL BE COMPLETED IN A WAY THAT WILL PREVENT THE TRANSPORT OF SEDIMENT FROM THE CONSTRUCTION SITE TO RECEIVING WATERS.
- SOIL AND OTHER STOCKPILES MUST BE STABILIZED AND PROTECTED WITH SEDIMENT-TRAPPING MEASURES.
- ALL POLLUTANTS, INCLUDING WASTE MATERIALS AND DEMOLITION DEBRIS, THAT OCCUR ON SITE DURING CONSTRUCTION SHALL BE HANDLED AND DISPOSED OF IN A MANNER THAT DOES NOT CAUSE CONTAMINATION OF STORMWATER.
- MAINTENANCE AND REPAIR OF HEAVY EQUIPMENT AND VEHICLES AND OTHER ACTIVITIES WHICH MAY RESULT IN DISCHARGE OR SPILLAGE OF POLLUTANTS TO THE GROUND OR INTO STORMWATER RUNOFF MUST BE CONDUCTED USING SPILL PREVENTION MEASURES APPROVED BY THE OWNER'S REPRESENTATIVE.
- WATER FROM MOST DEWATERING OPERATIONS SHALL BE DISPERSED IN AN ADJACENT VEGETATED AREA AS APPROVED BY THE OWNER. THE CONTRACTOR SHALL PROTECT PRIVATE PROPERTY, EXISTING DITCHES, AND EXISTING DRAINAGE CHANNELS FROM SCOUR AND EROSION RESULTING FROM DEWATERING OPERATIONS. HIGHLY TURBID OR CONTAMINATED DEWATERING WATER SHALL BE HANDLED SEPARATELY FROM STORMWATER AND PROPERLY DISPOSED.
- THE CONTRACTOR SHALL PRESERVE NATURAL LANDSCAPE, AND PRESERVE AND PROTECT EXISTING VEGETATION NOT REQUIRED OR OTHERWISE AUTHORIZED TO BE REMOVED, AS OUTLINED IN THE SPECIFICATIONS.

PROJECT SPECIFIC TESC NOTES:

- THE TESC PLAN DRAWINGS SHOWN ARE CONCEPTUAL. THE CONTRACTOR IS REQUIRED TO SUBMIT DETAILED TESC PLANS AND A CONSTRUCTION STORMWATER POLLUTION PREVENTION PLAN (SWPPP) TO THE OWNER FOR APPROVAL PER THE REQUIREMENTS OF THE CONTRACT DOCUMENTS.
- THE CONTRACTOR IS RESPONSIBLE FOR THE CARE AND DIVERSION OF WATER DURING CONSTRUCTION IN ACCORDANCE WITH LOCAL, STATE, AND FEDERAL WATER QUALITY STANDARDS AND PROJECT PERMIT REQUIREMENTS.
- TESC IMPLEMENTATION AND MAINTENANCE SHALL COMPLY WITH ALL PROJECT PERMIT REQUIREMENTS.
- THE CONTRACTOR SHALL NOT FUEL EQUIPMENT OR STORE FUEL AT ELEVATIONS LOWER THAN 5 FEET ABOVE THE ORDINARY HIGH WATER (OHW) OF THE NEAREST STREAM OR SURFACE WATER BODY.

CONSTRUCTION SEQUENCE:

- SCHEDULE AND CONDUCT A PRE-CONSTRUCTION CONFERENCE WITH THE OWNER, OWNER'S REPRESENTATIVE, THE CONTRACTOR, SUB-CONTRACTOR SUPERINTENDENTS, THE CONTRACTOR'S ESCM, THE ENGINEER, AND LOCAL JURISDICTION REPRESENTATIVES AS APPROPRIATE. THIS MEETING SHALL BE HELD A MINIMUM OF 48 HOURS PRIOR TO THE START OF WORK.
- FLAG CLEARING LIMITS AND EXISTING TREES TO REMAIN.
- CONSTRUCT STABILIZED CONSTRUCTION ENTRANCES.
- INSTALL SILT FENCE.
- COMPLETE CLEARING AND GRUBBING
- INSTALL TEMPORARY WATER DIVERSION FACILITIES AND DEWATER THE PORTION OF THE EXISTING STREAM CHANNEL TO BE MODIFIED AS NECESSARY.
- COMPLETE IN-CHANNEL WORK, INCLUDING MOVING AND PLACING IN-CHANNEL ROCK AND OTHER MATERIALS.
- COMPLETE SURFACE RESTORATION AND PLANTING.
- DURING CONSTRUCTION, MAINTAIN AND UPGRADE TESC BMPS AS NEEDED TO PREVENT SEDIMENT FROM LEAVING THE SITE.
- REMOVE TESC BMPS AFTER SURFACE IS RESTORED AND/OR SEEDED AND GROWING.
- SEQUENCE SHALL BE ADAPTED, AS NEEDED, FOR OPTIONAL ITEMS INCLUDED DURING CONSTRUCTION.



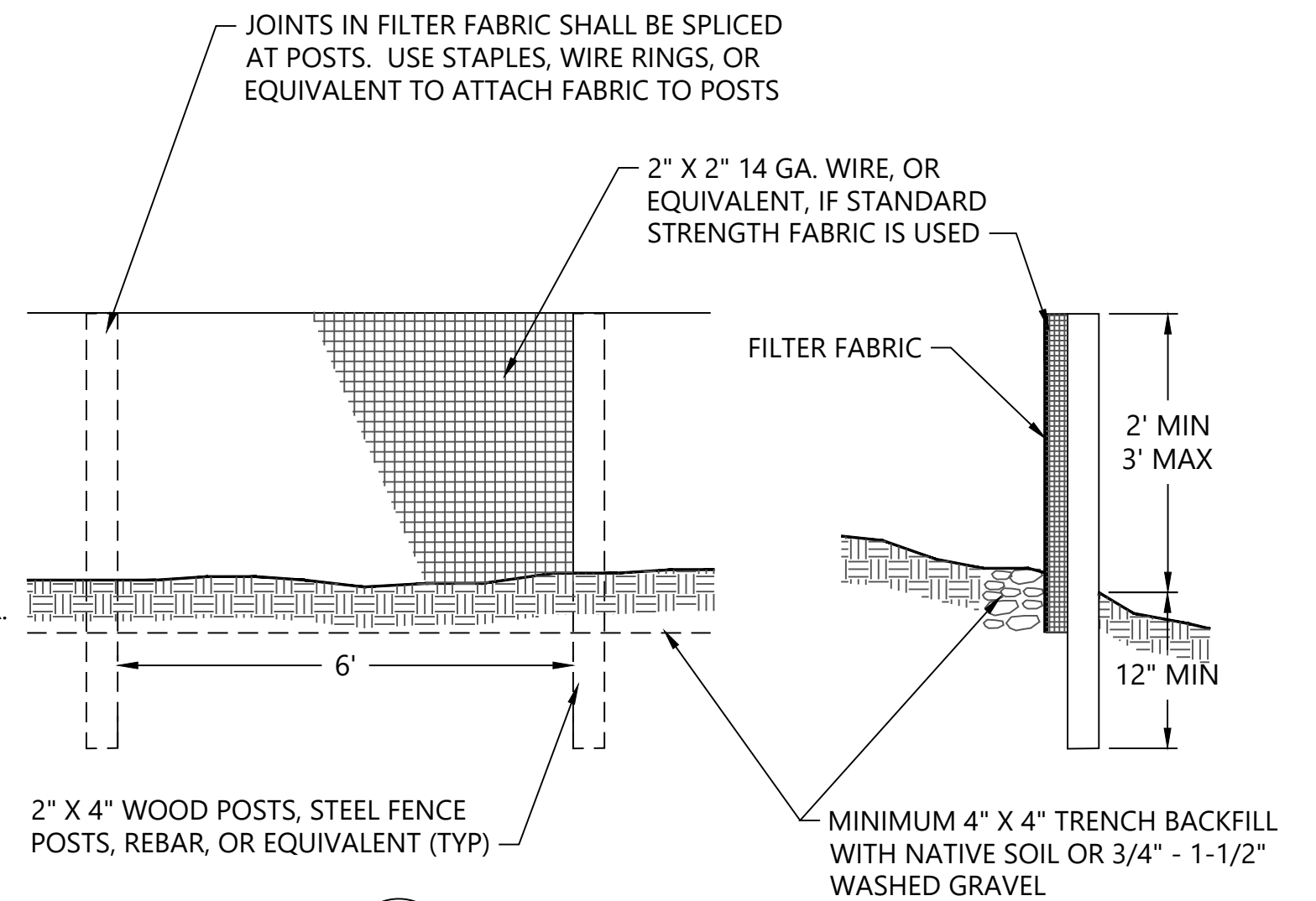
1 STABILIZED CONSTRUCTION ENTRANCE
SCALE: NOT TO SCALE

STABILIZED CONSTRUCTION ENTRANCE MAINTENANCE STANDARDS:

- QUARRY SPALLS (OR HOG FUEL) SHALL BE ADDED IF THE PAD IS NO LONGER IN ACCORDANCE WITH THE SPECIFICATIONS.
- IF THE ENTRANCE IS NOT PREVENTING SEDIMENT FROM BEING TRACKED ONTO PAVEMENT, THEN ALTERNATIVE MEASURES TO KEEP THE STREETS FREE OF SEDIMENT SHALL BE USED. THIS MAY INCLUDE STREET SWEEPING, AN INCREASE IN THE DIMENSIONS OF THE ENTRANCE, OR THE INSTALLATION OF A WHEEL WASH. IF WASHING IS USED, IT SHALL BE DONE ON AN AREA COVERED WITH CRUSHED ROCK, ASPHALT OR CONCRETE AND WASH WATER SHALL DRAIN TO A SEDIMENT TRAP OR POND. WHEEL WASH WASTEWATER SHOULD NOT BE COMMINGLED WITH STORM WATER OR DISCHARGED TO THE STORM WATER TREATMENT SYSTEM.
- ANY SEDIMENT THAT IS TRACKED ONTO PAVEMENT SHALL BE REMOVED IMMEDIATELY BY SWEEPING. THE SEDIMENT COLLECTED BY SWEEPING SHALL BE REMOVED OR STABILIZED ON SITE. THE PAVEMENT SHALL NOT BE CLEANED BY WASHING DOWN THE STREET, EXCEPT WHEN SWEEPING IS INEFFECTIVE AND THERE IS A THREAT TO PUBLIC SAFETY. IF IT IS NECESSARY TO WASH THE STREETS, THE CONSTRUCTION OF A SMALL SUMP SHALL BE CONSIDERED. THE SEDIMENT WOULD THEN BE WASHED INTO THE SUMP WHERE IT CAN BE CONTROLLED.
- ANY QUARRY SPALLS THAT ARE LOOSENEED FROM THE PAD AND END UP ON THE ROADWAY SHALL BE REMOVED IMMEDIATELY.
- IF VEHICLES ARE ENTERING OR EXITING THE SITE AT POINTS OTHER THAN THE CONSTRUCTION ENTRANCE(S), FENCING SHALL BE INSTALLED TO CONTROL TRAFFIC.

NOTES:

- FILTER FABRIC FENCES SHALL BE INSTALLED ALONG CONTOUR WHENEVER POSSIBLE.
- WHERE APPROVED BY KITTITAS COUNTY CONSERVATION DISTRICT, STRAW WATTLES MAY BE USED IN THE PLACE OF SILT FENCE ADJACENT TO STREAMS AND OTHER SENSITIVE AREAS TO LIMIT DISTURBANCE. SUBSTITUTION OF STRAW WATTLE FOR SILT FENCE SHALL IN NO WAY ALLEVIATE THE CONTRACTOR'S RESPONSIBILITY FOR PREVENTING SEDIMENT AND SEDIMENT-LADEN RUNOFF FROM ENTERING SWAUK CREEK OR ANY OTHER SURFACE WATER.



2 SILT FENCE
SCALE: NOT TO SCALE

FILTER FABRIC FENCE INSTALLATION:

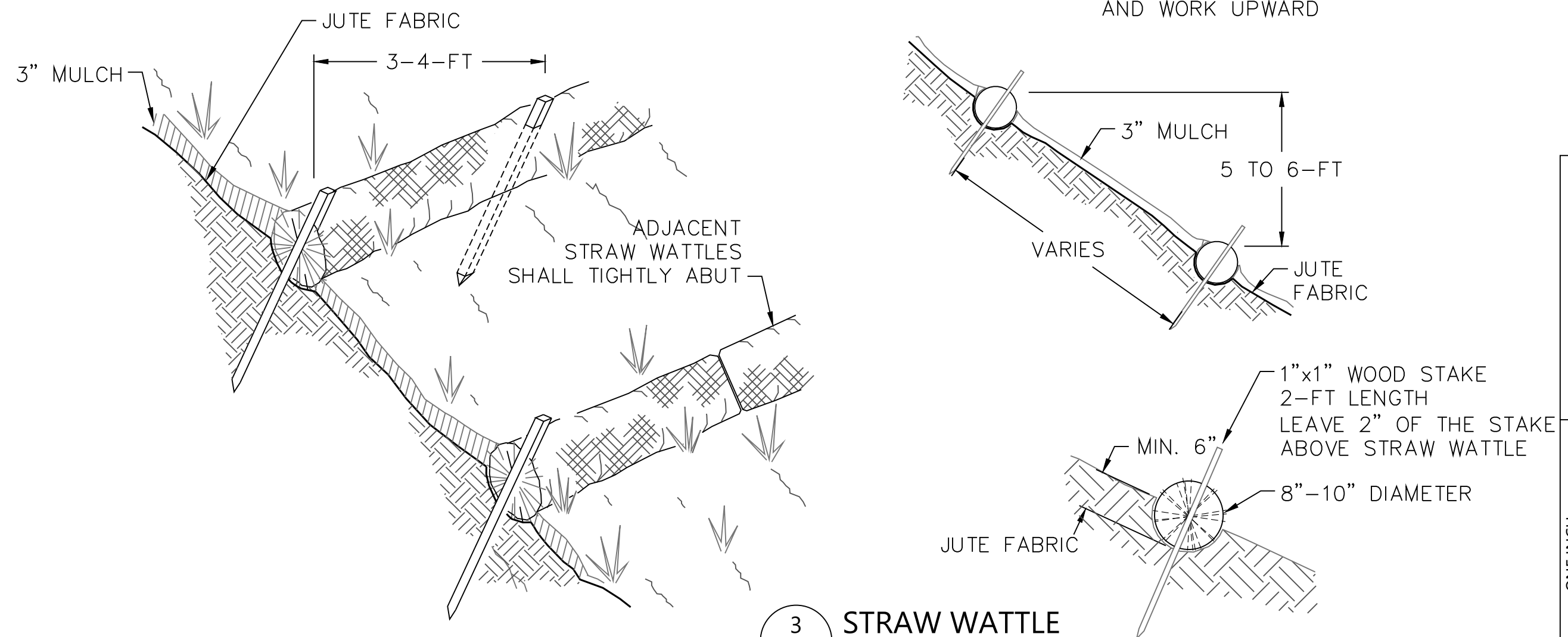
- MAXIMUM SLOPE STEEPNESS (NORMAL (PERPENDICULAR) TO FENCE LINE): 1H:1V
- MAXIMUM SHEET OR OVERLAND FLOW PATH LENGTH TO THE FENCE: 100 FEET
- NO CONCENTRATED FLOWS GREATER THAN 0.5 CFS.
- FILTER FABRIC: MIRAFI 100X, OR APPROVED EQUAL
- THE FILTER FABRIC SHALL BE PURCHASED IN A CONTINUOUS ROLL CUT TO THE LENGTH OF THE BARRIER TO AVOID USE OF JOINTS. WHEN JOINTS ARE NECESSARY, FILTER CLOTH SHALL BE SPICED TOGETHER ONLY AT A SUPPORT POST, WITH A MINIMUM 6-INCH OVERLAP, AND BOTH ENDS SECURELY FASTENED TO THE POST.
- POSTS SHALL BE SPACED A MAXIMUM OF 6 FEET APART AND DRIVEN SECURELY INTO THE GROUND A MINIMUM OF 18 INCHES. A MINIMUM DEPTH OF 12 INCHES IS ALLOWED IF TOPSOIL OR OTHER SOFT SOIL IS NOT PRESENT AND A MINIMUM DEPTH OF 18 INCHES CANNOT BE REACHED. FENCE POST DEPTHS SHALL BE INCREASED BY 6 INCHES IF THE FENCE IS LOCATED ON SLOPES OF 3:1 OR STEEPER.
- A TRENCH SHALL BE EXCAVATED APPROXIMATELY 4 INCHES WIDE AND 4 INCHES DEEP ALONG THE LINE OF POSTS AND UPSLOPE FROM THE BARRIER. THE TRENCH SHALL BE CONSTRUCTED TO FOLLOW THE CONTOUR.
- A WIRE MESH SUPPORT FENCE SHALL BE FASTENED SECURELY TO THE UPSLOPE SIDE OF THE POSTS USING HEAVY-DUTY WIRE STAPLES AT LEAST 1 INCH LONG, THE WIRES OR HOG RINGS. THE WIRE SHALL EXTEND INTO THE TRENCH A MINIMUM OF 4 INCHES AND SHALL NOT EXTEND MORE THAN 36 INCHES ABOVE THE ORIGINAL GROUND SURFACE.
- THE FILTER FABRIC SHALL BE WIRED TO THE FENCE, AND 4 INCHES OF THE FABRIC SHALL EXTEND INTO THE TRENCH. THE FABRIC SHALL NOT EXTEND MORE THAN 36 INCHES ABOVE THE ORIGINAL GROUND SURFACE.
- FILTER FABRIC SHALL NOT BE STAPLED TO EXISTING TREES. OTHER TYPES OF FABRIC MAY BE STAPLED TO THE FENCE.

SILT FENCE MAINTENANCE STANDARDS:

- ANY DAMAGE SHALL BE REPAIRED IMMEDIATELY.
- IF CONCENTRATED FLOWS ARE EVIDENT UPHILL OF THE FENCE, THEY MUST BE INTERCEPTED AND CONVEYED TO A SEDIMENT TRAP OR POND.
- IT IS IMPORTANT TO CHECK THE UPHILL SIDE OF THE FENCE FOR SIGNS OF THE FENCE CLOGGING AND ACTING AS A BARRIER TO FLOW AND THEN CAUSING CHANNELIZATION OF FLOWS PARALLEL TO THE FENCE. IF THIS OCCURS, REPLACE THE FENCE OR REMOVE THE TRAPPED SEDIMENT.
- SEDIMENT MUST BE REMOVED WHEN THE SEDIMENT IS 6 INCHES HIGH.
- IF THE FILTER FABRIC (GEOTEXTILE) HAS DETERIORATED DUE TO ULTRAVIOLET BREAKDOWN, IT SHALL BE REPLACED.

NOTES:

- STRAW WATTLES MUST BE PLACED CONTINUOUSLY ALONG ALL FINISHED SLOPE CONTOURS AT 10-FOOT VERTICAL INTERVALS
- RUN-OFF MUST NOT BE ALLOWED TO RUN UNDER OR AROUND INSTALLED STRAW WATTLE ROLL.
- HORIZONTAL SPACING DEPENDS ON SLOPE STEEPNESS
- PLACE STRAW WATTLES OVER JUTE FABRIC
- DRIVE STAKES PERPENDICULARLY INTO SLOPE
- INSTALL WATTLES FROM BOTTOM OF SLOPE AND WORK UPWARD



3 STRAW WATTLE
SCALE: NTS

PERMIT-NOT FOR CONSTRUCTION

PLAN INTENDED TO BE VIEWED IN COLOR. ADJACENT BLOCK IS "BLUE" INCH SCALE ACCORDINGLY

K:\Projects\2114-Knife River Corporation-NW\Waters Quarry Expansion\Construction Plans\2114-SC-SEBLES.dwg SC2

Nov 30, 2023 1:01pm chiewett



REVISIONS				
REV	DATE	BY	APP'D	DESCRIPTION

DESIGNED BY: J. FOX
 DRAWN BY: D. HOLMER
 CHECKED BY: J. FOX
 APPROVED BY: G. SUMMERS
 SCALE: AS NOTED
 DATE: OCTOBER 2023

WATERS QUARRY PHASE II PROJECT
KNIFE RIVER CORPORATION

TEMPORARY EROSION AND SEDIMENTATION CONTROL NOTES AND DETAILS

SC2

SHEET # 22 OF 22

Appendix F

Example Deed Restriction

**EXAMPLE DECLARATION OF COVENANTS AND RESTRICTIONS and
ACCESS EASEMENT**

FOR THE

{Watters Quarry Expansion Project, Corps permit #NWP-_____, DSL permit # _____}

THIS DECLARATION of deed restriction (herein "Deed restriction") is made by

_____ Weyerhaeuser Company ("Declarant").

RECITALS

1. Declarant is the owner of the real property described in Exhibit "A," attached hereto and by this reference incorporated herein (the "Property"), and has designated the Property as a compensatory mitigation site in accordance with Removal-Fill Permit # _____ (the "DSL Permit") approved by the Oregon Department of State Lands ("Department"), and the Department of the Army permit #NWP-_____ ("Corps permit") approved by the US Army Corps of Engineers ("Corps").

2. Declarant desires and intends to provide for the perpetual protection and conservation of the wetland and waterway functions and values of the Property and for the management of the Property and improvements thereon, and to this end desires to subject the Property to the covenants, restrictions, easements and other encumbrances hereinafter set forth, each and all of which is and are for the benefit of the Property;

3. The Department has accepted the mitigation plan for the Property under ORS 196.800 et seq, and the Corps has likewise accepted the mitigation plan under Section 404 of the Clean Water Act and/or Section 10 of the Rivers and Harbors Act.

ARTICLE 1
DEFINITIONS

1.1 "Declaration" shall mean the covenants, restrictions, easement, and all other provisions set forth in the Declaration of Covenants and Restrictions.

1.2 "Declarant" shall mean and refer to _____ (landowner name), the owner of the Property, and the owner's heirs, successors, and assigns.

1.3 "DSL permit" shall mean the final document approved by the Department that includes the mitigation plan and which formally establishes the mitigation site and stipulates the terms and conditions of its construction, operation and long-term management. A copy of the DSL permit may be obtained at the Department of State Lands, 775 Summer St. NE, Salem, OR 97301; phone 503-986-5200.

1.4 "Corps permit" shall mean the final document approved and issued by the Corps which includes the mitigation plan describing where and how the compensatory mitigation will be completed, monitored, managed, and maintained. A copy of the Corps permit associated with this Declaration may be obtained at the office of the US Army Corps of Engineers, Regulatory Branch, 333 SW First Ave., Portland, OR 97208; Phone 503-808-4373.

1.5 "Property" shall mean and refer to all real property subject to this Declaration, as more particularly set forth in Exhibit "A."

ARTICLE 2
PROPERTY SUBJECT TO THIS DECLARATION

The Property described in Exhibit A is and shall be held, transferred, sold, conveyed and occupied subject to this Declaration.

ARTICLE 3

DECLARANT REPRESENTATIONS

Declarant represents and warrants that after reasonable investigation, and to the best of its knowledge, that no hazardous materials or contaminants are present that conflict with the conservation purposes intended; that the Property is in compliance with all federal state, and local laws, regulations, and permits; that there is no pending litigation affecting, involving, or relating to the Property that would conflict with the intended conservation use; and that the Property is free and clear of any and all liens, claims, restrictions, easements and encumbrances that would interfere with the ability to protect and conserve the Property.

ARTICLE 4

GENERAL DECLARATION

Declarant, in order to discharge in part its obligations under the DSL permit and the Corps permit, declares that the Property shall be held, transferred, sold, conveyed and occupied subject to the covenants, restrictions, easements and other encumbrances in this Declaration, in order that it shall remain substantially in its restored, enhanced, preserved, open and natural condition, in perpetuity. The terms and conditions of this Declaration shall be both implicitly and explicitly included in any subsequent transfer, conveyance, or encumbrance affecting all or any part of the Property. No modification or release of this Declaration will be effective unless authorized in writing by the Department and by the Corps. Any amendments must be signed by the Department and must be recorded in the official records of the county in which the Property is located.

ARTICLE 5
USE RESTRICTIONS, MANAGEMENT RESPONSIBILITIES,
AND RESERVED RIGHTS

Declarant is subject to any and all easements, covenants and restrictions of record affecting the Property.

A. USE RESTRICTIONS. Except as necessary to conduct, remediate or maintain the Property consistent with the DSL permit and the Corps permit, the actions prohibited by this covenant include:

1. There shall be no removal, destruction, cutting, trimming, mowing, alteration or spraying with biocides of any native vegetation in the Property, nor any disturbance or change in the natural habitat of the Property unless it promotes the mitigation goals and objectives established for the Property. Hazard trees that pose a specific threat to existing structures including fences or pedestrian trails may be felled and left on site. Dry grass only may be mowed after July 1 to abate fire hazard.
2. There shall be no agricultural, commercial, or industrial activity undertaken or allowed in the Property; nor shall any right of passage across or upon the Property be allowed or granted if that right of passage is used in conjunction with agricultural, commercial or industrial activity.
3. No domestic animals shall be allowed to graze or dwell on the Property.
4. There shall be no filling, excavating, dredging, mining or drilling; no removal of topsoil, sand, gravel, rock minerals or other materials, nor any storage nor dumping of ashes, trash, garbage, or of any other material, and no changing of the topography of the land of the Property in any manner once the wetlands are constructed unless approved in writing by the Department and by the Corps.
5. There shall be no construction or placing of buildings, mobile homes, advertising signs, billboards or other advertising material, vehicles or other structures on the Property.
6. There shall be no legal or de facto division, subdivision or partitioning of the protected Property.
7. Use of motorized off-road vehicles is prohibited except on existing roadways.

B. MANAGEMENT RESPONSIBILITIES. Declarant shall take all reasonable action to prevent the unlawful entry and trespass by persons whose activities may degrade or harm the mitigation purposes of the Property or that are otherwise inconsistent with this Declaration.

C. RESERVED RIGHTS. Declarant reserves all other rights accruing from Declarant's ownership of the Property including but not limited to the exclusive possession of the Property, the right to transfer or assign Declarant's interest in the same; the right to take action necessary to prevent erosion on the Property, to protect the Property from losing its wetland or waterway functions and values, or to protect public health or safety; and the right to use the Property in any manner not prohibited by this Declaration and which would not defeat or diminish the conservation purpose of this Declaration.

The Declarant specifically reserves the right to use the Property for the purposes of _____, which reserved rights are deemed to be consistent with the purposes enumerated in the permit.

ARTICLE 6

EASEMENT (RIGHT OF ENTRY)

Declarant hereby grants to the Department an easement and right of entry on the Property for the purpose of physically accessing the Property at all reasonable times to inspect the Property in order to monitor and to ascertain whether there has been compliance with this Declaration and the DSL permit. In the event that the Property lacks access via a public road or other common area, Declarant grants to the Department an easement over and across any other property of Declarant, the use of which is necessary to access the Property. The Declarant hereby grants to the Corps a right of entry to ascertain compliance with the Corps permit and this Declaration.

ARTICLE 7

GENERAL PROVISIONS

A. NOTICE. The Department and the Corps shall be provided with a 60-day advance written notice of any legal action concerning this Declaration, or of any action to extinguish, void or modify this Declaration, in whole or in part. This Declaration, and the covenants, restrictions, easements and other encumbrances contained herein, are intended to survive foreclosure, tax sales, bankruptcy proceedings, zoning changes, adverse possession, abandonment, condemnation and similar doctrines or judgments affecting the Property. A copy of this recorded Declaration shall accompany said notice.

B. VALIDITY. If any provision of this Declaration, or the application thereof to any person or circumstance, is found to be invalid, the remainder of the provisions of this Declaration, or the application of such provisions to persons or circumstances other than those as to which it is found to be invalid, as the case may be, shall not be affected thereby.

Appendix G

DSL Payment Calculator for In-Lieu Fee Programs

Payment Calculator for DSL-provided Wetland Mitigation and for Estimating Financial Securities for Permittee-Responsible Mitigation
Effective June 1, 2021

Step 1: Check your impact site location on the [Mitigation Banks Map](#).
 If there is a mitigation provider with appropriate wetland credits serving your area please contact the provider to determine eligibility, credit availability, price, and terms.

Step 2: If there is no mitigation provider with appropriate wetland credits for your project location, proceed with the payment calculator below. Fill in impact area, land value, and zoning for the development site per the instructions below to determine the payment for mitigation credits. The payment calculator may also be used to estimate financial securities for permittee-responsible mitigation. Please be aware payment in lieu does not satisfy mitigation requirements for the US Army Corps of Engineers.

*Instructions: Insert the requested information in yellow highlighted cells.
 Payment required is calculated in the green highlighted cell.*

Enter the DSL Application Number:		<i>Enter the DSL-assigned application number, if known (APP0000000)</i>
Area to be mitigated (acres)	11.56	<i>Insert the acreage of the wetland loss that must be mitigated. Enter to the nearest 0.01-acre for impacts greater than 0.01 of an acre or to the nearest 0.001-acre for impacts less than 0.01 of an acre.</i>
Tax lot acreage (impact site)	227.72	<i>Insert the total acreage of the tax lot where impact is located</i>
Real market land value of tax lot	\$ 3,798,650.00	<i>Insert the real market <u>land</u> value for the tax lot; do not include the value of structures or improvements. Refer to the most recent property tax statement from the county assessor* or from a recent land appraisal. The proportional cost of the area to be mitigated is used in the payment calculation.</i>
Zoning Adjustment Factor	0.8	<i>Insert the correct adjustment from table 1 based on the zoning of the tax lot being impacted</i>
Restoration cost (per acre)	\$ 28,796.00	<i>Insert the restoration cost from table 2 for the basin where the impact is located</i>
PAYMENT REQUIRED:	\$ 2,830,179.74	Payment = (RMV + R + LT + A)*mm or calculated to not exceed maximum cost per acre. See information below.

Table 1: Zoning Adjustment Factor

Description of Zoning	Proportion of RMV to be included
Residential zoned properties with improvements such as utilities and subdivision infrastructure	0.5
Properties zoned commercial, industrial, or zoned residential without improvements	0.8
Properties zoned for agriculture, forestry, conservation use, and public reserve	1

Table 2: Restoration Cost by Basin

Basin (6 digit hydrologic unit code)*	Wetlands (per acre)
Black Rock Desert (160402)	\$27,996
Deschutes River Basin (170703)	\$39,832
John Day River Basin (170702)	\$27,996
Klamath River Basin (180102)	\$35,899
Lower Columbia (170800)	\$28,796
Lower Snake (170601)	\$30,754
Middle Columbia River Basin (170701)	\$39,524
Middle Snake-Boise (170501)	\$27,996
Middle Snake-Powder (170502)	\$27,996
Northern Oregon Coastal (171002)	\$24,670
Oregon Closed Basins (171200)	\$27,996
Southern Oregon Coastal (171003)	\$20,979
Upper Sacramento (180200)	\$27,996
Willamette River Basin (170900)	\$24,886

Payment Calculator DSL-provided Stream Mitigation and for Estimating Financial Securities for Permittee-Responsible Mitigation
Effective June 1, 2021

Step 1: Check your impact site location on the [Mitigation Banks Map](#). If there is a mitigation provider with appropriate stream credits serving your area please contact the provider to determine eligibility, credit availability, price, and terms.

Step 2: If there is no mitigation provider with appropriate stream credits for your project location, proceed with the payment calculator below. Fill in impact area, land value, and zoning for the development site per the instructions below to determine the payment for mitigation credits. The payment calculator may also be used to estimate financial securities for permittee-responsible mitigation. Please be aware payment in lieu does not satisfy mitigation requirements for the US Army Corps of Engineers.

*Instructions: Insert the requested information in yellow highlighted cells.
 Payment required is calculated in the green highlighted cell.*

Enter the DSL Application Number:		Enter the DSL-assigned application number, if known (APP0000000)
Linear feet of stream impact	787	Insert the linear feet of the stream impact that must be mitigated.
Width of stream at ordinary high water level	2	Insert the average stream width. Average stream width should be measured at the level of ordinary high water.
Tax lot acreage (impact site)	97.15	Insert the total acreage of the tax lot where the impact is located.
Real market land value of tax lot	\$ 3,798,650.00	Insert the real market land value for the tax lot; do not include the value of structures or improvements. Refer to the most recent property tax statement from the county assessor* or from a recent land appraisal. The proportional cost of the area to be mitigated is used in the payment calculation.
Zoning Adjustment Factor	0.8	Insert the correct adjustment from table 1 based on the zoning of the tax lot being impacted.
Restoration Cost (per liner foot)	\$147	Insert the restoration cost from table 2 for the basin where the impact is located.
PAYMENT REQUIRED:	\$ 166,678.60	Payment = (RMV + R + LT + A)*mm. See information below.

Table 1: Zoning Adjustment Factor

Description of Zoning	Proportion of RMV to be included
Residential zoned properties with improvements such as utilities and subdivision infrastructure	0.5
Properties zoned commercial, industrial, or zoned residential without improvements	0.8
Properties zoned for agriculture, forestry, conservation use, and public reserve	1

Table 2: Restoration Cost by Basin

Basin (6 digit hydrologic unit code)*	Streams (liner foot)
Black Rock Desert (160402)	\$191
Deschutes River Basin (170703)	\$174
John Day River Basin (170702)	\$209
Klamath River Basin (180102)	\$191
Lower Columbia (170800)	\$147
Lower Snake (170601)	\$168
Middle Columbia River Basin (170701)	\$251
Middle Snake-Boise (170501)	\$108
Middle Snake-Powder (170502)	\$267
Northern Oregon Coastal (171002)	\$278
Oregon Closed Basins (171200)	\$191
Southern Oregon Coastal (171003)	\$193
Upper Sacramento (180200)	\$163
Willamette River Basin (170900)	\$248

Appendix H
Lease Renewal



Knife River Corporation - Northwest
 32260 Old Hwy 34
 Tangent, OR 97389-9770
 Ph: (541) 918-5100

CCB# 2101

www.kniferiver.com

Corporate Office: Fax (541) 918-5375
 AR Dept.: Fax (541) 918-5376
 HR/Payroll Dept.: Fax (541) 918-5378
 Willamette Valley: Fax (541) 928-6490

June 5, 2017

Mary Castle
 Area Engineer
 Weyerhaeuser NR Company
 33671 S. Dickey Prairie Road
 Molalla, OR 97038

Re: Watters Quarry Aggregate and Rock Products Lease Renewal

Dear Mary:

Knife River Corporation – Northwest (fka Morse Bros., Inc.) is hereby notifying Weyerhaeuser NR Company of its intent to renew per Section 2.2 of the Aggregate and Rock Products Lease Agreement dated August 31, 1992. The leased property is located at 60371 Hwy 30, St. Helens, OR 97051 in Township 5 N., Range 1 W., Section 32, Tax Lot 1600, Section 32DD TL 100, Section 33 Tax Lots 300 & 400, Columbia County, Oregon.

This extension shall be according to the same terms of the lease and will be for a period of five years commencing on the expiration date of August 31, 2017 and will continue until August 31, 2022.

Please contact Jeff Steyaert at 541-918-5142 if you have any questions.

Sincerely,

Steve Mote
 Vice President

Cc: Brian Gray, President
 Brandon Bond, General I
 Jeff Steyaert, Environme

SENDER: COMPLETE THIS SECTION	COMPLETE THIS SECTION ON DELIVERY	
<ul style="list-style-type: none"> ■ Complete items 1, 2, and 3. ■ Print your name and address on the reverse so that we can return the card to you. ■ Attach this card to the back of the mailpiece, or on the front if space permits. 	<p>A. Signature <input checked="" type="checkbox"/> Agent <input type="checkbox"/> Addressee</p>	
<p>1. Article Addressed to:</p> <p>MARY CASTLE AEA ENGINEER, Weyerhaeuser 33671 S. Dickey PRAIRIE Rd. MOLALLA, OR 97038</p>	<p>B. Received by (Printed Name) John Walter</p>	
	<p>C. Date of Delivery 6-14</p>	
<p>2. Article Number (Transfer from service label)</p> <p>7016 1370 0000 8339 2293</p>	<p>D. Is delivery address different from item 1? <input type="checkbox"/> Yes If YES, enter delivery address below: <input type="checkbox"/> No</p>	
	<p>3. Service Type</p> <p><input type="checkbox"/> Adult Signature <input type="checkbox"/> Adult Signature Restricted Delivery <input checked="" type="checkbox"/> Certified Mail® <input type="checkbox"/> Certified Mail Restricted Delivery <input type="checkbox"/> Collect on Delivery <input type="checkbox"/> Collect on Delivery Restricted Delivery <input type="checkbox"/> Mail Restricted Delivery</p> <p><input type="checkbox"/> Priority Mail Express® <input type="checkbox"/> Registered Mail™ <input type="checkbox"/> Registered Mail Restricted Delivery <input checked="" type="checkbox"/> Return Receipt for Merchandise <input type="checkbox"/> Signature Confirmation™ <input type="checkbox"/> Signature Confirmation Restricted Delivery</p>	

Attachment E

Removal-Fill Volumes

Attachment E

Watters Quarry Expansion Project

Removal Area and Volume Summary Table

Table E-1
Joint Permit Application Block 4(F) – Removal Volumes and Dimensions

Wetland/Waterbody Name*	Removal Dimensions ¹					Duration of Impact	Material
	Average Length (feet)	Average Width (feet)	Average Depth (feet)	Total Area (acres)	Total Volume (cubic yards) ²		
Wetland D	Varies	Varies	Varies	0.89	10,409	Permanent	Native soil/Organic Material
Wetland E	Varies	Varies	Varies	0.21	1,490	Permanent	Native soil/Organic Material
Wetland H	Varies	Varies	Varies	0.01	16	Permanent	Native soil/Organic Material
Wetland I	Varies	Varies	Varies	0.002	3	Permanent	Native soil/Organic Material
Wetland J	Varies	Varies	Varies	0.001	2	Permanent	Native soil/Organic Material
Wetland K ³	Varies	Varies	Varies	0.005	8	Permanent	Native soil/Organic Material
Wetland L	Varies	Varies	Varies	0.05	80	Permanent	Native soil/Organic Material
Wetland M	Varies	Varies	Varies	5.66	50,016	Permanent	Native soil/Organic Material
Wetland N	Varies	Varies	Varies	2.43	18,598	Permanent	Native soil/Organic Material
Wetland O	Varies	Varies	Varies	0.06	95	Permanent	Native soil/Organic Material
Wetland P	Varies	Varies	Varies	0.002	4	Permanent	Native soil/Organic Material
Wetland Q	Varies	Varies	Varies	0.004	7	Permanent	Native soil/Organic Material
Wetland R	Varies	Varies	Varies	0.004	7	Permanent	Native soil/Organic Material
Wetland S	Varies	Varies	Varies	0.0002	0.4	Permanent	Native soil/Organic Material
Wetland T	Varies	Varies	Varies	0.08	252	Permanent	Native soil/Organic Material
Wetland AA	Varies	Varies	Varies	0.22	1,054	Permanent	Native soil/Organic Material
Wetland BB	Varies	Varies	Varies	0.04	66	Permanent	Native soil/Organic Material
Wetland CC	Varies	Varies	Varies	0.25	1,913	Permanent	Native soil/Organic Material

Wetland QQ	Varies	Varies	Varies	0.1	164	Permanent	Native soil/Organic Material
Wetland RR	Varies	Varies	Varies	0.03	49	Permanent	Native soil/Organic Material
Wetland SS	Varies	Varies	Varies	0.01	12	Permanent	Native soil/Organic Material
Wetland XX	Varies	Varies	Varies	0.01	4	Permanent	Native soil/Organic Material
Wetland YY	Varies	Varies	Varies	0.02	80	Permanent	Native soil/Organic Material
Wetland ZZ	Varies	Varies	Varies	0.05	264	Permanent	Native soil/Organic Material
Total Removal Area and Volume for Wetlands				10.14	90,248		
Intermittent Stream C	52	2	1	0.002	4	Permanent	Native soil/Organic Material/Bedrock
Total Removal Area and Volume for Other Waters				0.002	4		
TOTAL REMOVAL AREA AND VOLUME				10.14	90,252		

Notes:

1. Because the proposed removal areas are irregular shapes, all dimensions are variable.
2. Removal volumes were calculated based on the approximate depth of soil above bedrock.
3. DSL has determined that these wetlands and other waters are non-jurisdictional under the Oregon Removal-Fill Law per the wetland delineation concurrence letter for WD #2019-0623, which was issued to the applicant on October 15, 2020 (DSL 2020).

Attachment F

Stormwater Pollution Prevention Plan

STORM WATER POLLUTION CONTROL PLAN

Site Name:

Knife River Watters Quarry

60371 Hwy 30, St. Helens, OR 97051

File Number 108484

NPDES 1200-A Permit

DOGAMI Number 05-0018

August 8, 2019

Columbia County

**Prepared by: Jeff Steyaert Knife River
Environmental MGR.**

Phone: (541) 918-5142

Jeff.steyaert@kniferiver.com

Site Contact: Jeff Steyaert

Phone: (541) 918-5142

Jeff.steyaert@kniferiver.com

Owner:

Knife River Corporation - NW

32260 Old Hwy 34

Tangent, Oregon, 97389

(541) 918-5100

Prepared For: Knife River Corporation NW
32260 Old Highway 34
Tangent, OR 97389

Site Location:

Latitude: 45.8758
Longitude: -122.8171

Address: 60371 Hwy 30
St. Helens, Oregon 97051

USGS Topo Sheet: St. Helens
USGS DRG: o45122g7
USGS Topo Sheet: Deer Island
USGS DRG: o45122h7

Columbia County County
T5N, R1W, Sec 33: Tax lot 300, 83.95 acres
T5N, R1W, Sec 33: Tax lot 400, 109.64 acres
(Portion of this TL).
T5N, R1W, Sec 32: Tax lot 1600, 43.89
T5N, R1W, Sec 32(DD) Tax Lot 100, 35.50 acres
(Portion of this TL).

Permit 1200-A; File 108484
DOGAMI Permit #: 05-0018

Site Contact: Jeff Steyaert
Phone: (541) 918-5142

Prepared By: Jeff Steyaert
Knife River Corporation - NW
32260 Old Hwy 34
Tangent, Oregon, 97389
541- 918-5142 (FAX) 541-918-5375

Table of Contents

SIGNATURE PAGE	i
REVISION PAGE	ii
1 INTRODUCTION	ii
1.1 BACKGROUND	1
1.2 PURPOSE	2
1.3 PLAN REQUIREMENTS	2
1.4 DEFINITIONS	2
2 Storm Water Pollution Control Plan	5
2.1 COVER PAGE	5
2.2 SITE DESCRIPTION	5
2.2.1 <i>General Description</i>	5
2.2.2 <i>Site-Specific Information</i>	5
2.2.2.1 Discharge outfalls	6
2.2.2.2 Buildings, structures and pavement	7
2.2.2.3 Storage or disposal areas for Significant Materials	7
2.2.3 <i>Potential Pollutants</i>	7
2.2.4 <i>Significant Materials</i>	7
2.2.5 <i>Receiving Body of Water</i>	8
2.2.6 <i>Stormwater run-on and non-stormwater</i>	8
2.2.7 <i>Stormwater Monitoring</i>	8
2.2.7.1 Monitoring and Testing Procedures	8
2.3 SITE CONTROLS	8
2.3.1 <i>Existing Control Measures</i>	8
2.3.2 <i>Recommended Control Measures</i>	9
2.3.3 <i>Products for Spill Control</i>	11
2.3.4 <i>Containment</i>	11
2.3.5 <i>Oil and Grease</i>	11
2.3.6 <i>Waste Chemicals and Material Disposal</i>	11
2.3.7 <i>Erosion and Sediment Control</i>	11
2.3.8 <i>Debris Control</i>	11
2.3.9 <i>Stormwater Diversion</i>	11
2.3.10 <i>Covering Activities</i>	11
2.3.11 <i>Housekeeping</i>	12
2.3.12 <i>Dust Generation and Vehicle Tracking</i>	11
2.4 PROCESS AND, EXCAVATION DEWATERING ACTIVITIES, SETTLING PONDS AND SANITARY WASTE	12
2.5 SPILL PREVENTION AND RESPONSE PROCEDURES	12
2.5.1 <i>Chemicals or Other Hazardous Materials</i>	14
2.5.2 <i>Notification Contacts</i>	15
2.5.3 <i>Reporting Spills</i>	16
2.5.4 <i>Preventive Maintenance Program</i>	16
2.5.4.1 Maintenance Inspection Procedures	16
2.5.4.2 Maintenance Procedures	16
2.6 EMPLOYEE EDUCATION PROGRAM	17
2.6.1 <i>New Employee Orientation</i>	17
2.7 REPORTING	17

2.7.1	<i>Monitoring Data</i>	17
2.8	IMPLEMENTATION SCHEDULE	18
2.9	PLAN REVIEW	18
2.9.1	<i>Plan Revision</i>	18
2.9.2	<i>Annual Review</i>	18

APPENDICES

APPENDIX A

- **Figure 1: Location Map**
- **Figure 2: Site Map**
- **Figure 3: Shop Chemical Storage Map**
- **Figure 4: Crusher Chemical Storage Map**

APPENDIX B

NPDES 1200-A Permit

APPENDIX C

- **Oregon DEQ Recommended Best Management Practices for Storm Water Discharges**
- **Oregon DEQ Biofilters for Storm Water Discharge Pollution Removal**
- **Oregon DEQ Deminimus Activities Allowed by the Wash Water Permit**
- **Oregon DEQ BMPs for Washing Activities**

APPENDIX D

- **Stormwater Monitoring/Sampling Requirements**
- **Stormwater Employee Training**
- **Training Record**
- **Stormwater Discharge Data Summary**
- **Stormwater System Maintenance Record**
- **Spill Notification Record**
- **Spill Information Form**
- **Daily Checklist Form**
- **Agency Written Report Form**

SIGNATURE PAGE

The 1200-A permit requires the Stormwater Pollution Control Plan (SWPCP) be signed in accordance with 40 CFR 122.22. Updates and revisions to the Plan are also to be signed in this manner. In signing the SWPCP, the authorized facility representative is attesting that the information contained in the plan is true and accurate. The SWPCP is to be signed as follows regardless of the number of employees.

For a Corporation – By a responsible corporate officer, this includes the president, secretary, treasurer, or vice-president. A manager may also sign if authority has been delegated to the manager in accordance with corporate procedures.

For a Partnership or Sole Proprietorship – By a general partner or the proprietor, respectively.

I certify under penalty of law this document and all attachments were prepared under my direction or supervision in accordance with a system designed to assure qualified personnel properly gathered and evaluated the information submitted. Based on my inquiry of the person or persons who manage the system, or those persons directly responsible for gathering the information, the information submitted is, to the best of my knowledge and belief, true, accurate, and complete. I am aware there are significant penalties for submitting false information, including the possibility of fine and imprisonment for knowing violations.

Authorized Knife River Corporation - NW Representative

SIGNATURE: Jeffrey R. Heyzel

DATE: 8-9-2019

REVISION PAGE

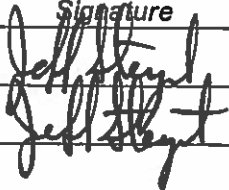
1 INTRODUCTION

This SWPCP (Plan) must be revised in compliance with condition A.7 and clearly identify changes to activities on site and control measures. SWPCP revisions must be submitted if there is a change in site contact, response to a corrective action or inspection, site or control measures that may significantly change the nature of pollutants present in stormwater or significantly increase the pollutant(s) levels, discharge frequency, or discharge volume or flow rate, change to monitoring locations or outfalls. Submission to DEQ or Agent of the revised pages of the SWPCP or site map must be within 30 days. A complete Plan review should be conducted annually, before the rainfall season begins.

All revisions to the SWPCP must be documented. The Plan Revision Documentation Form should be used to record the date, author, and name and signature of the facility representative that authorized the revision. The signature of the authorized facility representative attests the SWPCP revision information is true and accurate.

I certify under penalty of law this document and all attachments were prepared under my direction or supervision in accordance with a system designed to assure that qualified personnel properly gathered and evaluated the information submitted. Based on my inquiry of the person or persons who manage the system, or those persons directly responsible for gathering the information, the information submitted is, to the best of my knowledge and belief, true, accurate, and complete. I am aware that there are significant penalties for submitting false information, including the possibility of fine and imprisonment for knowing violations.

SWPCP Revision Documentation

<i>Revision Number</i>	<i>Revision Date</i>	<i>Revision Author</i>	<i>Revisions</i>	<i>Knife River Representative Signature</i>
0	March 23, 2013	Jeff Steyaert		
1	Aug. 8, 2019	Jeff Steyaert	Updated site contact & added discharge points	
2				
3				
4				
5				
6				

1.1 Background

In November of 1990, the Environmental Protection Agency (EPA) adopted rules found in 40 Code of Federal Regulations (CFR) 122, 123, and 124 that require National Pollutant Discharge Elimination System (NPDES) permits for stormwater discharges from certain municipalities and industry. For designated industries, permits are required if there are point source discharges of stormwater associated with industrial activity to surface waters.

The 1200-A general permit covers facilities with primary Standard Industrial Classification code 14, Mining and Quarrying of Nonmetallic Minerals, Except Fuels, that may discharge stormwater from a point source to surface waters or conveyance systems that discharge to surface waters. Also, asphalt mix batch plants and concrete batch plants, including mobile operations of this type, are required to obtain coverage under the permit. This permit may cover multiple non-metallic mining and quarrying sites under single ownership, each of less than 10 disturbed acres where only mining activities are conducted.

Knife River Corporation-NW developed the following Stormwater Pollution Control Plan (SWPCP) for the Knife River Watters Quarry located in St. Helens, Oregon. The plan was developed pursuant to requirements of the Federal Clean Water Act (40 CFR Part 122.26), NPDES General Permit Number 1200-A, National Pollutant Discharge Elimination System, and Stormwater Discharge Permit File No. 108484 issued by the Oregon Department of Environmental Quality.

The 1200-A permit requires a SWPCP (Plan) be prepared by a person knowledgeable in stormwater management and familiar with the facility. A person qualified in stormwater management may be the plant manager, environmental manager, facility engineer, or any other person with knowledge of the SITE and stormwater management practices.

This SWPCP was drafted to meet requirements of the new 1200-A stormwater permits effective December 4, 2012.

1.2 Purpose

This Plan is a general guidance document for use by Knife River personnel in controlling pollution releases to surface water from the facility located at 60371 Hwy 30, St. Helens, Oregon. The Plan is intended to guide Knife River personnel in evaluating stormwater pollution control strategies; maintaining existing stormwater control structures; and developing and implementing appropriate stormwater pollution controls.

The pollution control methods outlined in the Plan are intended to meet the requirements for storm water pollution control as defined in General Permit 1200-A, Schedule A, Stormwater Pollution Control Plan. If stormwater monitoring results indicate exceedance of the permit parameter benchmarks and other pollution controls are necessary the Plan should be modified accordingly.

1.3 Plan Requirements

The format and content of the Plan is consistent with the criteria defined in permit 1200-A. The Plan is based on guidelines within the DEQ General 1200-A permit effective December 2012.

1.4 Definitions

The following provide definitions of pertinent terms used throughout this Plan as defined in the DEQ General 1200-A permit effective December 2012.

Best Management Practices (BMPs) schedules of activities, practices (and prohibitions of practices), structures, vegetation, maintenance procedures, and other management practices to prevent or reduce the discharge of pollutants to waters of the state. BMPs also include treatment requirements, operating procedures and practices to control plant site runoff, spillage or leaks, sludge or waste disposal, or drainage from raw materials storage. See 40 CFR 122.2.

BOD means five-day biochemical oxygen demand.

Capital improvements are defined as the following:

- Treatment best management practices including but not limited to settling basins, oil/water separation equipment, grassy swales, detention or retention basins and media filtration devices.
- Manufacturing modifications that incur capital expenditures, including process changes for reduction of pollutants or wastes at the source.
- Concrete pads, dikes, and conveyance or pumping systems utilized for collection and transfer of storm water to treatment systems.
- Roofs and appropriate covers for manufacturing areas.
- Volume reduction measures, including low impact development control measures.

CBOD means five-day carbonaceous biochemical oxygen demand.

Composite sample means a sample formed by collecting and mixing discrete samples taken periodically and based on time or flow.

Discharge outfall or point source refers to any discernible, confined, and discrete conveyance, including, but not limited to any pipe, ditch, channel, tunnel, conduit, well, or discreet fissure from which pollutants are or may be discharged.

FC means fecal coliform bacteria.

Grab sample means an individual discrete sample collected over a period of time not to exceed 15 minutes.

Impervious surfaces refer to surfaces that will not allow storm water runoff to infiltrate into the natural ground.

kg means kilograms.

m³/d means cubic meters per day.

mg/l means milligrams per liter.

MGD means million gallons per day.

Month means calendar month.

NPDES refers to the National Pollutant Discharge Elimination System

POTW means a publicly owned treatment works.

Quarter means January through March, April through June, July through September, or October through December.

Significant materials include, but are not limited to: raw materials, fuels, materials such as solvents, detergents, and plastic pellets, finished materials such as metallic products, raw materials used in food processing or production, hazardous substances designated under Section 101(14) of the Comprehensive Environmental Response, Compensation, and Liability Act (CERCLA); any chemical the facility is required to report pursuant to Section 313 of Title III of the Superfund Amendments and Reauthorization Act (SARA); fertilizers; pesticides; and waste products such as ash, slag and sludge that have the potential to be released with storm water discharges.

Stormwater runoff means water discharges as a result of rain, snow, or other precipitation.

SWPCP is the Stormwater Pollution Control Plan.

Technology based permit effluent limitations means technology-based treatment requirements as defined in 40 CFR 125.3, and concentration and mass load effluent limitations that are based on minimum design criteria specified in OAR 340-41.

The term “bacteria” includes but is not limited to fecal coliform bacteria, total coliform bacteria, and E. coli bacteria.

Total residual chlorine means combined chlorine forms plus free residual chlorine.

Week means a calendar week of Sunday through Saturday.

Other definitions not listed may be found in the DEQ General 1200-A permit, Schedule D Special Conditions and Schedule F, Section E.

2 Storm Water Pollution Control Plan

2.1 Cover Page

- Company Legal Name: Knife River Corporation NW
- Site name: Watters Quarry
60371Hwy30, St. Helens, OR. 97051
- Permit File Number: 108484
- Type of permit: 1200-A
- Dogami Number: 05-0018
- Date of SWPCP: August 8, 2019
- County: Columbia

Activities covered by a 1200-A Permit include facilities with Standard Industrial Classification code 14, *Mining and Facilitating of Nonmetallic Minerals, Except Fuels*. Watters Quarry has an SIC 1429 classification primarily engaged in mining or quarrying crushed and broken stone.

2.2 Site Description

2.2.1 General Description

The Knife River Watters quarry facility operates under DOGAMI permit 05-0018 and Oregon DEQ NPDES 1200-A, File #108484. The facility is located at 60371 Hwy 30, St. Helens, Oregon (Figure 1). The legal description of the site is;

T5N, R1W, Sec 33: Tax lot 300, 83.95 acres
T5N, R1W, Sec 33: Tax lot 400, 109.64 acres (Portion of this TL).
T5N, R1W, Sec 32: Tax lot 1600, 43.89
T5N, R1W, Sec 32(DD) Tax Lot 100, 35.50 acres (Portion of this TL).

Coordinates of the facility are latitude 45.8758°, longitude -122.8171°. The closest water body is the Columbia River located east of the site.

2.2.2 Site-Specific Information

The site consists of 269.36 acres of land. The site is comprised of the mine, future mine area, and former mine area undergoing reclamation. There is a small scale office, scale, shop storage building and portable crushing plant. The crushing plant is located in the central portion of the site. A high quality orthophotograph (Figure 2) is provided to detail the site stormwater drainage, buildings, equipment and surface waterbodies.

The impervious areas are the footprint of the scale office and mine equipment. The site is best described as >99% pervious. Mine and crushing plant drainage is

directed to a settling pond to help settle out the water if turbid. Stormwater is pumped out of the mine area and is discharged at Discharge Point 001.

Elevation at the site ranges from approximately 120 to 330 feet above mean sea level.

The mining method is drill and blast. The basalt rock is mined using excavator, dozer and haul trucks. The rock is processed using a screening and rock crushing plant. The area impacted by mining within the next five years is estimated at less than 5% of the site. Surrounding uses are vacant timber land and cemetery to the north; rural residential and residential subdivision to the west; vacant timber land to the south and industrial land and Hwy 30 to the east.

This site is utilized year round.

2.2.2.1 Discharge Points

The site has three discharge points (Discharge Points 001, 002 and 003) associated with mining activities. There are multiple discharges from the undisturbed forest land in Drainage Basin 4. The stormwater from the mine, crushing and stockpile area is diverted to the settling pond where, if necessary, is pumped to Discharge Point 001. Discharge Point 001 discharges to a Hwy 30 ditch that conveys runoff to the Columbia River east of Watters Quarry.

Drainage Basin 1 receives stormwater that is collected from the lower active mining, crushing and stockpile area that is mainly flat except for the active mining benches. The surfaces are basalt rock or gravel. Pollutants within this area are sediments from removing overburden, oils, antifreeze and diesel used in the wheel loader, dump trucks, dewatering pump and crushing equipment.

Drainage Basin 2 is mostly a paved haul road that is gradually sloped. Activities within this basin are trucks and equipment going in and out of the mine site to pick up aggregate materials. Potential pollutants are oils, antifreeze, diesel, gas that is used for trucks and equipment traveling within this basin. Stormwater is directed into a haul road ditch before sheet flowing into the Hwy 30 roadside ditch.

Drainage Basin 3 is paved where the trucks travel to the scales and exit. The site areas where trucks and equipment park is gravel. There is a small drum storage building where oils, grease and antifreeze are stored in 55 gallon drums within secondary containment. Stormwater sheet flows across the site to the southeast corner before discharging into the Hwy 30 roadside ditch.

Drainage Basin 4 is forest land that currently has no mining activities. There are multiple stormwater discharges from surface flow across the basalt surface.

2.2.2.2 Buildings, structures and pavement

The Knife River operation uses the following buildings/structures:

- Scale Office
- Shop storage
- Crushing plant

A small asphalt parking area is located adjacent to the office scales and roadway from the quarry to the scale office is paved.

2.2.2.3 Storage or disposal areas for Significant Materials

Significant materials are stored in the following areas:

Shop storage:

- 2-55 Gal. Chevron 15W-40
- 1-55 Gal. Chevron RPM 10W
- 1-55 Gal. Chevron Antifreeze
- 1-55 Gal. Chevron Transmission 30W
- 1-55 Gal. Chevron Gear Oil 80W-90
- 3-55 Gal. Used Oil

Crushing Plant:

- 3,140 Gal. Diesel tank Genset
- 600 Gal. Diesel tank VSI
- 250 Gal. Diesel tank Jaw
- 2-1/4 drums Grease
- 2-5Gal. Chevron Grease
- 2-5 Gal. Chevron Tera Synthetic Gear Oil

Quarry:

- 2,000 Gal. Diesel Fuel Truck

2.2.3 Potential Pollutants

The potential pollutants are diesel, antifreeze, grease and oils from trucks and equipment operating onsite. Sediments are generated from overburden removal and stockpiles, aggregate stockpiles, processing equipment, settling pond cleanout and haul roads onsite. Diesel, oils, antifreeze and grease are stored inside the lube shed to minimize exposure to stormwater.

On-site fuel tank truck used for equipment fueling has potential to pollute stormwater flowing off the site if spills or leaks occur.

2.2.4 Significant Materials

Significant materials include diesel fuel, motor oils, lubricants, antifreeze, and transmission fluids and used oil. The following is a list of significant materials and quantities stored onsite. All significant materials are used for regular maintenance and repair of mining equipment and vehicles.

2-55 Gal. Chevron 15W-40
1-55 Gal. Chevron RPM 10W
1-55 Gal. Chevron Antifreeze
1-55 Gal. Chevron Transmission 30W
1-55 Gal. Chevron Gear Oil 80W-90
3-55 Gal. Used Oil
3,140 Gal. Diesel tank Genset
600 Gal. Diesel tank VSI
250 Gal. Diesel tank Jaw
2-1/4 drums Grease
2-6Gal. Chevron Grease
2-5 Gal. Chevron Tera Synthetic Gear Oil
2,000 Gal. Diesel Fuel Truck

2.2.5 Receiving Body of Water

Discharge Points 001, 002 and 003 are located near the east side of the site adjacent to Hwy 30 (see Figure 2). The discharge points ultimately discharge to the Columbia River.

2.2.6 Storm water run-on and non-storm water

Stormwater run-on and non-storm water does not mix with stormwater flowing off the site.

2.2.7 Storm Water Monitoring

Discharge Points 001, 002 and 003 are located on the northeast side of Watters Quarry adjacent to Hwy 30. The discharge points are labeled on Figure 2 and are where the water is monitored.

2.2.7.1 Monitoring and Testing Procedures

The site specific map (Figure 2) depicts the location of the stormwater Discharge Points 001, 002 and 003. Grab samples representative of the discharge shall be taken during the monitoring year from July 1 – June 30.

2.3 Site Controls

2.3.1 Existing Control Measures

Most of the site is forest land. The area disturbed by mining is contoured such that stormwater is captured within the active mining site where it is directed away from the active mining area and contained within the settling pond. If the stormwater is clean enough, it is pumped from the settling pond to Discharge Point 001. Onsite employees monitor the clarity of the water before the pump is turned on and record the results. Oils and antifreeze drums are stored next to the shop within a locked lean to used to top off equipment fluid levels. There is no

major maintenance of equipment conducted onsite. Employees are trained annually in spill prevention and response and where they can find the spill kit supplies onsite in case of spills or leaks.

2.3.2 Recommended Control Measures

Preventive maintenance at the Knife River Watters Quarry facility will consist of:

- Daily when operating inspections of areas where potential spills of significant materials or industrial activities could impact stormwater.
- Monthly inspections of stormwater control measures, structures, catch basins, and treatment facilities.
- Cleaning, maintenance or repair of all materials handling and storage areas and all stormwater control measures, structures, catch basins, and treatment facilities as needed upon discovery. Cleaning, maintenance, and repair of such systems must be performed in such a manner as to prevent the discharge of pollution.
- An annual evaluation of areas that can be revegetated to minimize the size of the disturbed areas. Revegetation must take place prior to the onset of rain. Mulching or other stormwater management practices must be implemented to minimize erosion of vegetated areas until the vegetation is established.
- Developing and following a mining program that eliminates removal and stockpiling of overburden and other materials that easily erode during wet weather.
- An annual inspection of the stormwater control facilities and drainage systems prior to the wet weather period.
- A plan to remove material accumulated in settling ponds, catch basins, and similar facilities at least annually, and to store the material in allocation that will prevent erosion or discharge to surface waters.

The petroleum hydrocarbon stored onsite should have secondary containment to prevent storm water contamination if a rupture or leak occurs.

- Construct secondary containment for ASTs located at the portable crushing plant.
- Secondary containment for the mobile fuel truck.
- Locate all drums or containers of potential pollutants inside into covered storage areas or place inside secondary containment.

In addition, the following should be regularly employed.

- Maintain a stock of spill absorbent pads, booms, and socks adequate to contain spills of product. When using booms in a drainage channel the boom should be situated perpendicular to the water flow through the drainage channel, and should be securely attached to either side of the channel using rope.

- Train employees on the proper handling and rapid response of materials, which could affect storm water run-off.
- As a matter of routine practice all barrels containing significant materials should be covered and provision for spill control provided.
- During the rain season, regularly inspect and clean, when necessary, storm water outfall(s).

BMPs (Best Management Practices) references included in Appendix D are Oregon Department of Environmental Quality (DEQ) document Best Management Practices for Storm Water Discharges Associated with Industrial Activities - January 2001, Biofilters (Bioswales, Vegetative Buffers, & Constructed Wetlands) for Storm Water Discharge Pollution Removal - January 2003 and Recommended Best Management Practices for Washing Activities - March 1998.

In addition, the following table (modified from *Small Businesses and Hazardous Waste: What You Should Know* 1992: Portland, Oregon, Oregon Department of Environment Quality, P. 5-3) is included as a reminder for environmentally safe recycling procedures.

Waste Type	Common Management Method	Comments
Solvent	Disposal at a hazardous waste management facility	Solvents are not used at this site.
Paint Waste	Use, recycle (if possible), donate to someone who can use, solidify and landfill if latex, dispose at a hazardous waste management facility	Latex paint is usually not hazardous; oil based paint is often hazardous
Used oil	Recycle off-site, burn on-site for space heat in approved furnace	Not regulated as hazardous recycled; very often is hazardous
Used oil filters	Recycle, may go to a municipal waste landfill if drained or crushed	Used oil filters are exempt from being a hazardous waste when properly drained or crushed. ("Terne" plated filters are not exempt.)
Antifreeze	Recycle off-site	Not regulated as hazardous and recycled.
Batteries	Equipment batteries are recycled offsite	Batteries are taken to a knife River shop facility where batteries are recycled
Fluorescent Lamps	Recycled by an approved handler	Spent lamps are hauled offsite by an approved handler
Aerosol Cans	Aerosol cans are punctured in an approved device and recycled for metal.	Cans are taken to a Knife River shop that has an approved puncturing device.

2.3.3 Products for Spill Control

The following products are useful for absorbing spills or leaks:

- Assortment of absorbent pads, booms, snakes, socks, etc.
- Empty 55-gallon drums
- Roll of visqueen plastic
- Onsite materials are used to berm spills

Spill prevention and response procedures (SPRP) are designed to prevent or contain pollutant spills. SPRP for the Knife River Watters Quarry includes identification of areas where potential spills of significant materials can contact stormwater and the location of drainage channels to mitigate impact before discharge at Discharge Points 001, 002 and 003.

2.3.4 Containment

All hazardous materials must be stored within berms or have secondary containment. If not possible, storage must be in areas that do not drain to the storm sewer system.

2.3.5 Oil and Grease

All petroleum products should continue to be stored in enclosed storage areas and should have secondary containment to protect against accidental leaks or spills.

2.3.6 Waste Chemicals and Material Disposal

Used oil from onsite equipment is recycled regularly.

2.3.7 Erosion and Sediment Control

The site is relatively flat with a majority basalt or gravel surfaces. The only area we have any sediment issues is from around the crushing plant and overburden removal areas. A street sweeper is used when necessary to control sediment tracking within the internal paved haul roads just before the scales and Hwy 30 exit.

2.3.8 Debris Control

The site will be checked regularly for debris and trash. Screens, booms, or other measures must be used to control debris in stormwater discharge.

2.3.9 Stormwater Diversion

Stormwater must be diverted away from the active mining area to minimize sediments from entering the settling pond.

2.3.10 Covering Activities

Significant materials should be stored inside whenever possible.

2.3.11 Housekeeping

Regular inspections must be conducted in areas with potential to pollute storm-water. Areas where potential pollutants are stored outside should be checked frequently in the wet season to verify spills or leaks have not occurred.

2.3.12 Dust Generation and Vehicle Tracking

The Crushing plant at this facility has an Oregon DEQ Air Contaminant Discharge Permit which regulates not only emissions from this source but any fugitive dust from haul roads onsite. The plant has water spray nozzles at the crushers and transfer points to minimize particulate matter in the air. All the haul roads onsite are gravel and water is used if necessary to keep any fugitive dust down. The facility has adequate pavement at the exit to prevent track out of materials. If trackout becomes an issue a street sweeper is used to clean up the roadway surface at Hwy 30.

2.4 *Process and, Excavation Dewatering Activities, Settling Ponds and Sanitary Waste*

The 1200-A permit does not allow the discharge of process wastewater to surface waters of the state. All process water must be adequately controlled by settling, recirculation, controlled seepage, irrigation or use for dust control. Discharge of process wastewater to surface waters will require an application for and the issuance of an individual NPDES permit. Process wastewater includes the following:

- Process wastewater and waste solids from aggregate washing activities
- Wastewater and waste solids derived from air scrubber equipment
- Concrete mixer washout wastewater and waste solids
- Excavation dewatering water that has been mixed with process or other wastewater
- Stormwater that has mixed with process or other wastewater.

2.5 *Spill Prevention and Response Procedures*

If a spill occurs employees must immediately notify Jeff Steyaert, site spill coordinator (SSC). The SSC will assess the spill and determine the appropriate response. Safe operation is imperative!

- Small spills will be managed onsite with absorbent to contain and absorb liquid on pavement/concrete.
- Larger spills will be managed by placing a dike around the nearest storm water catch basin down gradient of the spill. The SSC will assess the contained material for the appropriate cleanup option.
- If the spill is on grass or soil, absorbent will be placed on residual liquid and if practical, the spill site covered with visqueen to prevent storm water contamination.

During the emergency, the site personnel will work to prevent the incident from spreading to other areas of the site. If appropriate, the SSC will temporarily stop facility operations to reduce the potential for further impact.

The following instructions for employees in a real or potential emergency should be posted at the entrances and exits of facility buildings:

- Notify the SSC or his designee as soon as a potential emergency is recognized.
- The first emergency response person at the scene will immediately assess the potential hazard. If the situation is considered an emergency that cannot be controlled by onsite personnel, offsite spill response will be called for (911).
- The SSC will direct on-scene management and emergency response.
- Depending on the severity the SSC will notify the appropriate community response unit or state/federal agencies.
- The SSC will direct offsite spill response units to the scene and provide information about the spill.
- Extinguish potential ignition sources.
- Plug or dike storm drains or ditches near spills.

When a spill occurs employees must be trained and familiar with the spill-cleanup procedures and equipment. Spill equipment must be maintained in sufficient quantity to address the most severe level of spill anticipated. When spill equipment/materials are used, they should be immediately replaced/decontaminated after each response.

The SSC will maintain a list of required clean-up equipment needed for responding to a spill, along with evidence that such equipment is on the site or readily available for use by trained personnel. A checklist will be maintained for spill supplies outlining inventory and necessary replacement supplies will be ordered if inventory is low.

In case of a spill or leak, the INITIAL RESPONSE should be the following:

- 1) Isolate the area, and deny entry to unnecessary personnel if hazardous materials are present.
- 2) Most significant materials stored onsite are flammable, i.e. petroleum products).
- 3) Initial action should be to mitigate fire, explosion and vapor hazards.
- 4) The Department of Environmental Quality should be contacted within 24 hours if more than 42 gallons are released, or if the responsible person is unable to contain or cleanup the release within 24 hours, or if a sheen is recognized on surface water.

- 5) *Release of petroleum product impacting surface runoff must be reported to the Oregon Emergency Response System (OERS) at the following: OERS (800) 452-0311. The OERS will contact all other local, county, state, and federal agencies.*
- 6) *As a backup for notifying the proper emergency response agencies, the National Response Center Hotline telephone number is the following: (800) 424-8802.*
- 7) Immediate action should be taken to prevent further release.

Employees should be aware of the following guidelines:

- Appropriate protective clothing and respiratory equipment should be used if the spilled product is recognized as hazardous.
- In the case of a leak, the source should be identified and eliminated, IF SAFE TO DO SO.
- The area surrounding the spilled product should be diked if the product is escaping the primary containment area.
- Excess product should be removed with pumps into temporary storage tanks.
- Residue should be soaked up with absorbent material such as clay, sand or absorbent socks.
- An authorized hazardous waste recycler should remove spilled product that has been pumped into temporary storage tanks and absorbent material used to soak up residue.

2.5.1 Chemicals or Other Hazardous Materials

In case of a spill of chemicals or other hazardous materials, the same procedures for emergency response and notification outlined in the SPRP will be followed.

2.5.2 Notification Contacts

SITE SUPERVISOR: KIRK MEYERS (503) 735-2167

SITE SPILL COORDINATOR: JEFF STEYAERT: (541) 918-5142
CELL: (541) 968-1898

ENVIRONMENTAL CONSULTANT: STEVE LA FRANCHI (541) 683-4997

CLEANUP CONTRACTOR : TERRA HYDRA INC. (503) 625-4000

ODOT INCIDENT RESPONSE: (503) 731-4652

OREGON EMERGENCY RESPONSE SYSTEM (OERS)

1 (800) 452-0311 (In State)
(503) 378-4124 (Out of State)

CHEMICAL TRANSPORTATION EMERGENCY CENTER (CHEMTREC)

1 (800) 424-9300

NATIONAL RESPONSE CENTER HOTLINE (NRC)

1 (800) 424-8802

2.5.3 Reporting Spills

The SSC will review the cause of the incident, the response, the cleanup, and other pertinent issues or circumstances. This information will be used to evaluate emergency procedures, training requirements, and institutional controls in case they need to be modified to reduce the chance of the incident reoccurring. A Spill Notification Record (Appendix D) must be completed to document the spill, actions taken and delivered to senior staff as soon as possible after the spill occurs.

When reporting a spill, the SSC will provide the following information:

- Name and telephone number of person reporting the incident.
- Name and address of the facility.
- Time, date and duration of the incident.
- Type of incident.
- Quantity and type of hazardous material involved.
- Number of persons, if any, exposed or injured.
- Potential for offsite release and hazards to human health or the environment.

If required by the EPA or DEQ a written report detailing the incident will be sent to the EPA regional administrator and the DEQ within 15 working days of the incident. The report must contain the information required in the Code of Federal Regulations, 40 CFR 265.56(j), and Oregon Administrative Rules, OAR 340-104-056(3).

2.5.4 Preventive Maintenance Program

Regular, routine preventive maintenance is critical to reducing the amount of pollutants contacting stormwater. A preventive maintenance program is implemented to insure the effective operation of materials management practices and structural/non-structural control measures used to comply with the requirements of this permit.

2.5.4.1 Maintenance Inspection Procedures

Inspections of areas where potential spills of significant materials could impact stormwater runoff, control structures, and any treatment facilities are made daily while operating, during the rainfall season, in conjunction with a visual observation of the stormwater outfall.

2.5.4.2 Maintenance Procedures

A regular program of cleaning and repairing stormwater control structures, treatment facilities, and materials handling and storage facilities are conducted throughout the rainfall season. During the dry season stormwater control structures should be inspected at least twice for the presence of non-stormwater discharges at the stormwater discharge outfall. At a minimum, the inspection

includes visual observations of flow to determine the presence of stains, sludges, odors, and other abnormal conditions.

- Inspect areas, daily while operating, where potential spills of significant materials or industrial activities could impact stormwater runoff on a routine basis.
- Inspect stormwater control measures, structures, catch basins and treatment facilities at least once a month.
- Cleaning, maintenance and/or repair of all materials handling and storage areas and all stormwater control measures, structures, catch basins, and treatment facilities as needed upon discovery. AST(s) will be inspected once a month.
- Good housekeeping practices will be employed. This will include:
 - Do not handle or store chemicals such as lubricating oils outside the vehicle refueling areas or other covered and bermed area
 - Do not overfill tank when dispensing diesel, gasoline, or lubricating oil

Conduct routine inspections and maintenance of equipment and vehicles to prevent leakage of oil, grease and fuels.

2.6 Employee Education Program

The employee awareness program is designed to inform personnel of the components and goals of the SWPCP and address spill response procedures, good housekeeping and material management practices. Existing employees will be trained in the objectives outlined in the SWPCP. All training will be completed within 90 days of the completion of the SWPCP.

2.6.1 New Employee Orientation

All new employees will be given an overview of the goals and objectives of the SWPCP Plan, spill response procedures and housekeeping practices, as well as training in materials handling practices specifically related to their job as part of the overall company new-hire orientation program. Education and training must occur within 30 calendar days of hiring an employee who works in areas where stormwater is exposed to industrial activities or conducts duties related to the implementation of the SWPCP, and annually thereafter.

2.7 Reporting

2.7.1 Monitoring Data

Knife River will gather monitoring data according to the conditions of NPDES General Permit 1200-A.

2.8 IMPLEMENTATION SCHEDULE

The permit registrant must implement interim measures to control the pollutants in the discharge within 30 days. Implement these measures until the final treatment measures are installed.

2.9 PLAN REVIEW

A full plan review will be conducted annually, before the onset of the rainfall season. The plan review will include a complete site inspection of all areas where potential spills of significant materials can impact stormwater runoff. The plan will be amended if more effective and field-proven control technology is available that will significantly reduce the likelihood of pollution from stormwater discharge to receiving waters.

The SWPCP will be amended within six months of a change in the facility design construction, operation or maintenance that materially affects the discharge of stormwater runoff from the facility.

A person knowledgeable in stormwater management and familiar with the site shall prepare any amendments to this SWPCP Plan.

2.9.1 Plan Revision

Updates to the SWPCP shall be submitted to DOGAMI within 14 days after completion. Submit to the following:

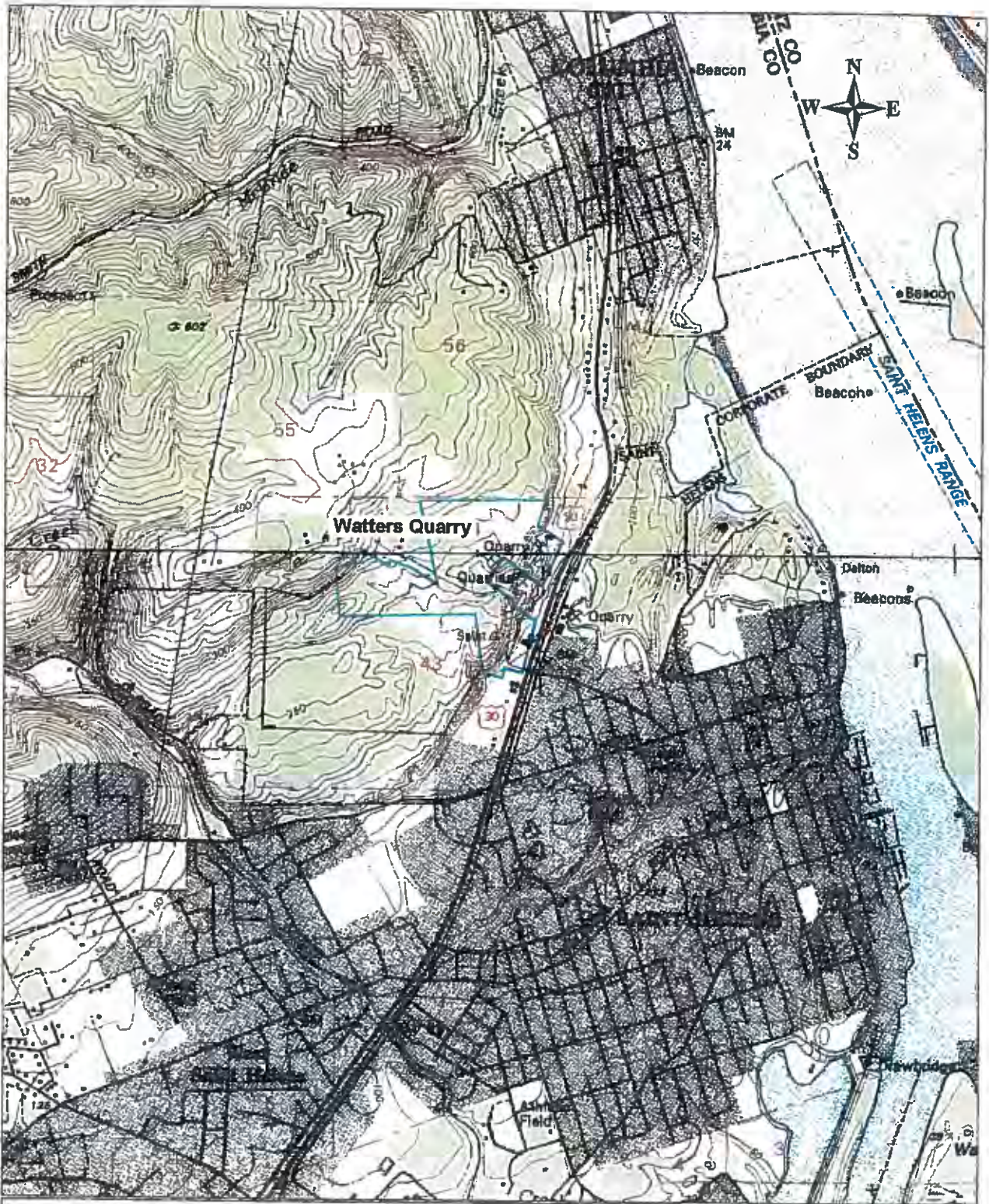
**Oregon Dept. of Geology
229 Broadalbin Street SW
Albany, Oregon 97321**

2.9.2 Annual Review

Employees will be given an overview of the goals and objectives of the SWPCP Plan, spill response procedures and housekeeping practices as part of the regular company safety and training program. Specific training in materials handling practices, the operation of stormwater pollution control structures, and procedures for taking stormwater samples and observations will be given to the employees responsible for these functions. This training will be reviewed on an annual basis or whenever required by modifications to the SWPCP Plan.

Appendix A

Figures



Morse Bros., Inc.
WATERS QUARRY
 60371 Highway 30
 St. Helens, Oregon

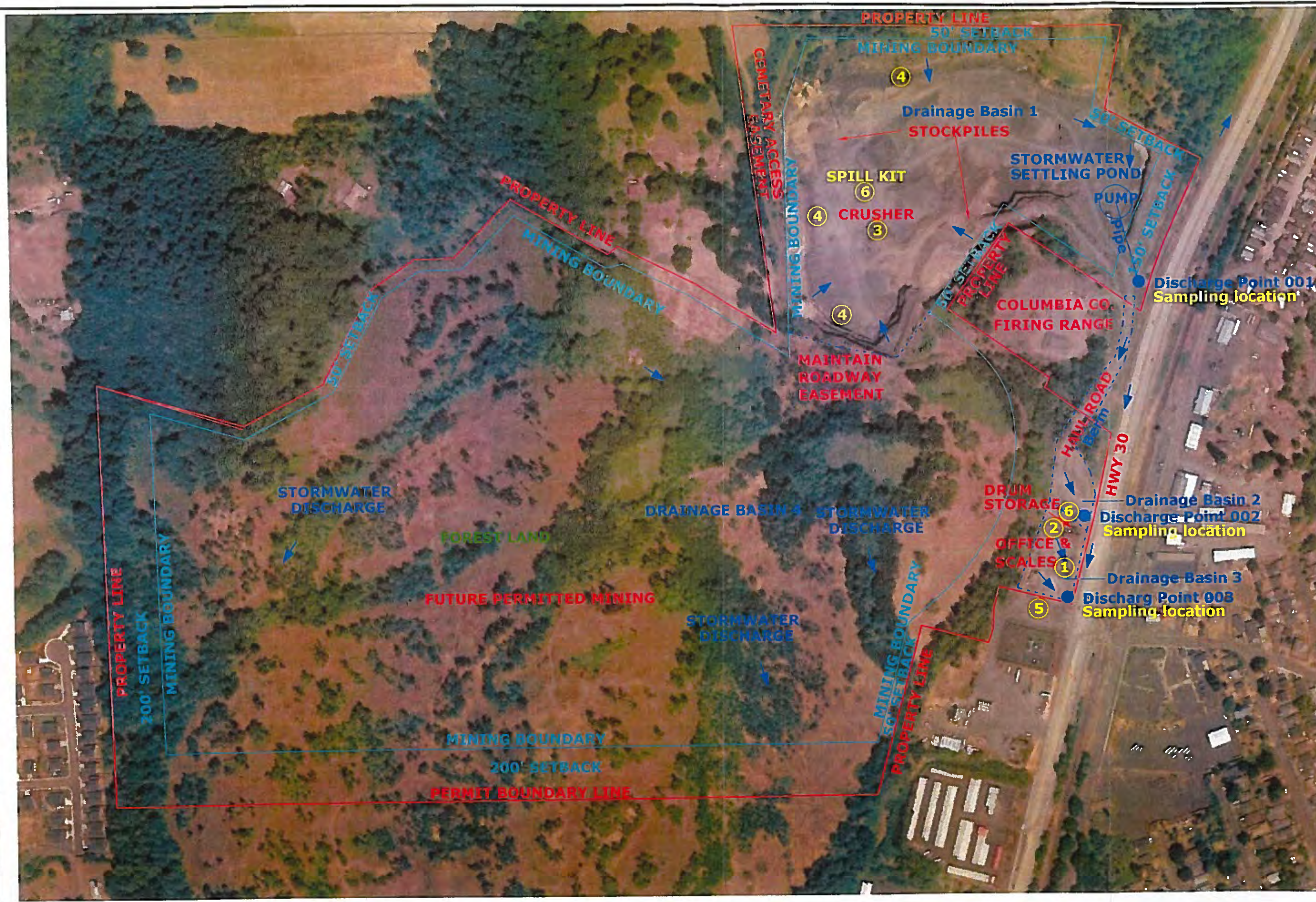
GENERAL LOCATION MAP

FIGURE 1

Source USGS DRG G7-45122 & H7-45122

Environmental Science Associates, Inc.
 2/4/02

Scale: 1" = 2000'



LEGEND:
 Property Line —
 Stormwater Flow —
 Mining Boundary —
 Discharge Point ●
 Spill Kit ●
 Inspection Location ①

FIGURE 2
SITE PLAN



KNIFE RIVER Watters Q.
 60371 Hwy 30
 St. Helens OR. 97051

Aerial Photo Dated: 2018



55 Gal. 15W-40 Oil
55 Gal. 10W Oil
55 Gal. 30W Oil
55 Gal. 80W-90 Oil
55 Gal. Antifreeze

**SHOP
STORAGE**

**OFFICE &
SCALES**

KNIFE RIVER-WATTERS Q. SITE
60371 HWY 30
St. Helens, OR 97051

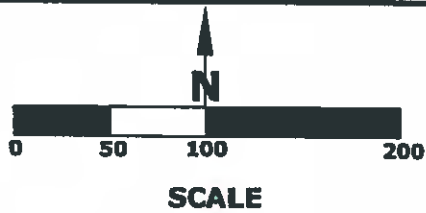
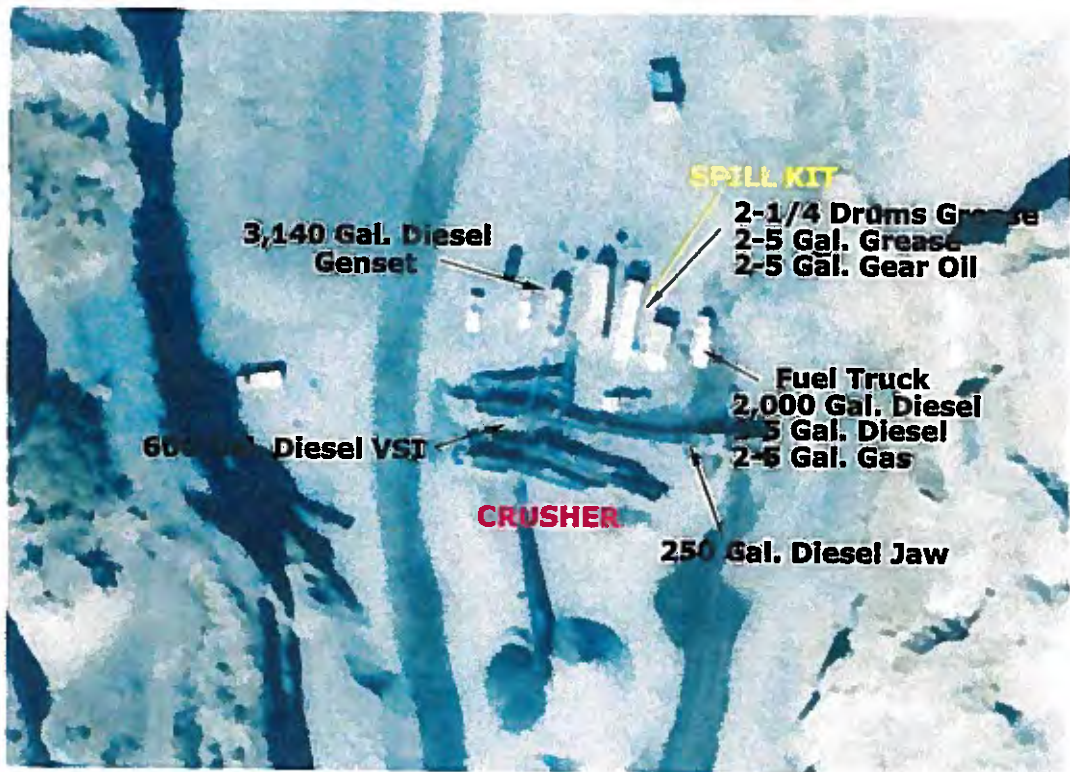


FIGURE 3
SHOP
Chemical Storage
Map

Aerial Photo dated 9-19-2007



KNIFE RIVER-WATTERS Q. SITE
60371 HWY 30
St. Helens, OR 97051

Aerial Photo dated 9-19-2007

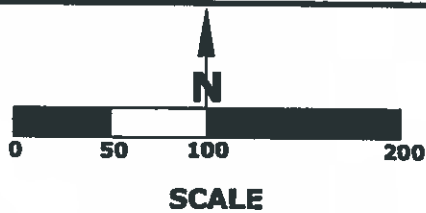


FIGURE 4
Portable Crusher
Chemical Storage
Map

Appendix B
NPDES 1200-A Permit

Appendix C
BMPs for Stormwater Discharges

Industrial Stormwater Best Management Practices Manual

By: Dennis Jurries, PE
Krista Ratliff

February 2013



State of Oregon
Department of
Environmental
Quality

**Water Quality Division
Surface Water Section**

811 SW 6th Avenue
Portland, OR 97204
Phone: (503) 229-5696
(800) 452-4011
Fax: (503) 229-6762
Contact: Erich
Brandstetter
www.oregon.gov/DEQ

DEQ is a leader in restoring, maintaining and enhancing the quality of Oregon's air, land and water.



This report prepared by:

Oregon Department of Environmental Quality
811 SW 6th Avenue
Portland, OR 97204
1-800-452-4011
www.oregon.gov/deq

Alternative formats (Braille, large type) of this document can be made available.
Contact DEQ's Office of Communications & Outreach, Portland, at (503) 229-5696, or toll-free in Oregon at 1-800-452-4011, ext. 5696.

Table of Contents

Executive Summary 1

Introduction..... 2

Best Management Practices 4

 BMP 1 Coolant/Oil Recovery 4

 BMP 2 Weld Fume Control 6

 BMP 3 Drum & Container Containment 7

 BMP 4 Tank Containment 9

 BMP 5 Metal Roof & Siding Coating, Gutter and Downspout Treatment..... 10

 BMP 6 Biological Based Parts Cleaners..... 11

 BMP 7 Lined Grease Containers 12

 BMP 8 Vehicle, Pavement and Building Washing..... 13

 BMP 9 Oil/Water Separators 15

 BMP 10 Oil/Water Separators for Air Compressors 17

 BMP 11 Oil and Sediment Trap Catch Basins..... 17

 BMP 12 Containers for Dust Collectors 19

 BMP 13 Ozone Generators for Cooling Towers..... 20

 BMP 14 Cartridge Filtration 21

 BMP 15 Sweeping 23

 BMP 16 Battery Storage 24

 BMP 17 Wrecked Vehicle Storage & Scrap Metal Recycling 25

 BMP 18 Paint Stripping..... 27

 BMP 19 Equipment Covers 28

 BMP 20 Brake Shoe Replacement..... 29

 BMP 21 Employee Environmental Training 30

 BMP 22 Housekeeping 31

 BMP 23 Lawn Care 33

 BMP 24 Dumpster Covering 36

 BMP 25 Semi-Trucks and Trailers 38

 BMP 26 Fueling and Liquid Loading/Unloading Operations..... 39

 BMP 27 Parking Lots and Yards 40

 BMP 28 Stormwater Diversion - Speed Bumps and Speed Humps 41

 BMP 29 Grassy Filter Strip and Planter 42

Industrial Stormwater Best Management Practices

BMP 30 Catch Basin Insert Bag	44
BMP 31 Constructed Wetlands.....	45
BMP 32 Bioswales.....	47
BMP 33 Sand Filters	49
BMP 34 Porous Pavers	50
BMP 35 Flocculation	50
BMP 36 Electrocoagulation.....	54
References.....	57

Industrial Stormwater Best Management Practices

BMP Selection: Table 1

- 1. Exposed Surfaces:** Roofs, Parking Lots, Loading areas, Equipment areas, Lawns, Buildings
- 2. Storage:** Dumpsters, Scrap Containers, Used Oil, Fueling, Other Stored Materials, Hazardous Waste
- 3. Equipment Usage/Maintenance:** Pump Liquids/Grease, Coolant Recovery, Compressors, Metal Work
- 4. Washing:** Pavement, Buildings, Vehicles, Equipment
- 5. Treatment Strategies:** Filtration, Settling, Infiltration, Flocculation, Diversion, Separation
- 6. Housekeeping/Training**

BMP Selection Table 1		
Activity or Condition	Pollutants Generated or Treated	BMP N^o
1. Exposed Surfaces: Roofs, Parking Lots, Loading areas, Equipment areas, Lawns, and Buildings		
Galvanized corrugated sheet metal roof and/or outside walls of buildings	Zinc, Iron	5
Steel, equipment, or vehicles stored outside	Oil and Grease, PAH, Suspended Solids	9
Exposed copper/galvanized piping, exposed copper, brass, or zinc coated materials, fork lift, vehicle and heavy vehicle traffic	Copper, Zinc, PAH, Total Suspended Solids	14 15
Stripping metal or wood surfaces outdoors	Hazardous stripping chemicals, lead from old lead based paints, zinc chromate from old paint preparations, metal particulate, low pH, and increased suspended solids	18
Poor housekeeping	Total Suspended Solids	22
Facilities with lawns or vegetated areas	Fertilizers, Pesticides, Herbicides, Fungicides, Phosphorus, Nitrogen, Zinc, Copper, pH	23
2. Storage: Dumpsters, Scrap Containers, Used Oil, Fueling, Other Stored Materials		
Oil (& Other Fluids) Dispensing & Outside Storage	Oil, Hydraulic Fluid, Antifreeze, Paint, Solvent, Cleaners, Petroleum Hydrocarbons, Toluene, Ethylene Glycol	3
Storage of liquids in bulk containers or tanks	Oils, Diesel, Gasoline(Petroleum Hydrocarbons), Antifreeze(Ethylene Glycol), and Solvents(Toluene, Mineral Oil)	3 4
Steel, equipment, or vehicles stored outside	Oil, Grease, Suspended Solids	9

Industrial Stormwater Best Management Practices

BMP Selection Table 1		
Activity or Condition	Pollutants Generated or Treated	BMP N^o
Arc furnace or mechanical removal operations creating dust that is collected in baghouses	Metal Fines, Suspended Solids	12
Replacement or storage of lead/acid or nickel/cadmium batteries or long time storage of vehicles or powered equipment outside	Lead, Nickel, Cadmium, Sulfuric Acid	16
Wrecked or damaged vehicle storage	Antifreeze (ethylene glycol), gasoline, oil, grease, brake fluid, diesel	17
Outdoor storage of materials	Oil & Grease, TSS, Metals	19
Poor housekeeping	Total Suspended Solids	22
Storage of general rubbish or food rubbish outside in dumpsters	Suspended Solids, Nutrients, Bacteria, Dioxin, Chemicals	24
Trucking operations	Oil and Grease	25
3. Equipment Usage/Maintenance: Pumping Liquids/Grease, Coolant Recovery, Compressors, Metal Work		
Mechanical metal removal	Heavy Metals, BOD ₅ , Bacteria, Fungicides Oil, Corrosion Inhibitors, Emulsifiers, Biocides, pH	1
Arc furnace or mechanical removal operations creating dust that is collected in baghouses	Metal Fines, Suspended Solids	2
Oil (& Other Fluids) Dispensing & Outside Storage	Oil, Hydraulic Fluid, Antifreeze, Paint, Solvent, Cleaners, Petroleum Hydrocarbons, Toluene, Ethylene Glycol	3
Vehicle maintenance, equipment maintenance, involving grease	Grease (Petroleum Hydrocarbons with heavy metal additives)	7
The use of cooling towers with the associated water treatment chemicals & blowdown discharges	Biocides, Algaecides, Fungicides, Corrosion Inhibitors(BOD ₅ , COD), Suspended Solids, Zinc, Copper, pH	13
Vehicle repair/brake shoe replacement	Asbestos, Copper, Total Suspended Solids	16 17
Fueling and other transfers of liquids	PAH, Antifreeze, Other Potentially Toxic or Hazardous Liquids	24
4. Washing: Pavement, Buildings, Vehicles, Equipment		

Industrial Stormwater Best Management Practices

BMP Selection Table 1		
Activity or Condition	Pollutants Generated or Treated	BMP N ^o
Parts & equipment cleaning in parts cleaners containing mineral spirits/oil or petroleum products	Petroleum Hydrocarbons	6
Pressure washing/steam cleaning of equipment and/or vehicles	Degreasers, Soap, Heavy Metals, Oil, Grease	8
5. Treatment Strategies: Filtration, Settling, Infiltration, Flocculation, Diversion, Separation		
Diversion	Fuel, Alcohol, Chemicals, TSS, others	28
Vegetated filter (buffer)	Sediment(TSS), Metals, BOD, Phosphorus, Hydrocarbons(Oil & Grease)	29
Catch Basin Filter System	Sediment(TSS), Metals, BOD, Phosphorus, Hydrocarbons(Oil & Grease)	30
Constructed Wetland	Sediment(TSS), Metals, BOD, Phosphorus, Hydrocarbons(Oil & Grease)	31
Grassy Bioswale	Sediment(TSS), Metals, BOD, Phosphorus, Hydrocarbons(Oil & Grease)	32
Sand Filter	Heavy Metals, BOD, TSS, Total Phosphorus	33
Storm Treat System	Sediment(TSS), Metals, BOD, Phosphorus, Hydrocarbons(Oil & Grease)	36
Porous Pavement	Hydrocarbons(Oil & Grease), Biodegradable Chemicals	34
Flocculation System	Sediment(TSS), Metals, BOD, Phosphorus, Hydrocarbons(Oil & Grease)	35
Coagulation/ElectroFloc	TSS and Heavy Metals	35
6. Housekeeping/Training:		
Employee environmental education and training	Facility specific pollutants	21
Housekeeping	Total Suspended Solids	22

Facilities that generate industrial process wastewater are regulated under separate National Pollutant Discharge Elimination System NPDES and/or Water Pollution Control Facilities WPCF.

****Wastewater mixed with stormwater is considered wastewater and cannot be discharged to waters of the state***

Executive Summary

This document is designed to aid in the selection and implementation of best management practices for the protection of water quality affected by industrial stormwater discharges.

BMPs, or source controls, are practices and/or procedures to prevent pollution in stormwater discharge, including methods to prevent toxic and hazardous substances from reaching receiving waters. They are designed to address the quality of a facility's practices and may ultimately affect the ability of the facility to meet effluent limits, impairment and sector-specific reference concentrations and/or benchmarks. BMPs are most effective when organized into a comprehensive Stormwater Pollution Control Plan. Several different source controls can be used to achieve similar environmentally protective results. With facility-specific or activity-specific pollutant(s) of concern as the major consideration(s) in selecting appropriate BMPs, facilities can tailor a Stormwater Pollution Control Plan to achieve permit compliance with available technologies.

The BMPs included in this document address activities and operations that take place outdoors and do not address pollutants from indoor industrial production. These BMPs are to be considered a work in process and are by no means a complete list of appropriate pollution control measures; DEQ may periodically add BMPs to this document.

Introduction

Background:

Under the Total Daily Maximum Load, or TMDL, program states must list waterbodies not meeting water quality standards and to determine, for each degraded waterbody, the “total maximum daily load” of the problematic pollutant that can be allowed without violating the applicable water quality standard. The regulating community or agency then determines what types of additional pollutant loading reductions are needed, considering not only point sources but also nonpoint sources. The regulator then establishes controls on these sources to ensure further reductions to achieve applicable water quality goals. National Pollutant Discharge Elimination permit conditions must respond to federal U.S. Environmental Protection Agency stormwater requirements, as well as TMDLs, which have been mandated by Congress to regulate stormwater discharges more rigorously. Locally in 2007 and 2008, two environmental advocacy groups, Northwest Environmental Defense Center and Columbia Riverkeeper, challenged the validity of the Oregon’s current industrial permits under the federal Clean Water Act. DEQ revised the industrial NPDES permit as part of a settlement agreement and implemented significant changes.

Organization:

This is a ‘living document’ with new additions generally added at the document’s end. Table 1, following the Reference section, is organized by type of activity and provides an index to the numbered BMPs for easy access to the body of information.

Best Usage:

The best way to use this guide is to assess your site’s *activities* that affect your stormwater discharge(s), using Table 1. Determine the pollutants in the stormwater discharge(s) and the potential sources of those pollutants on site, then determine which potential sources have the most significant impact on the discharge(s). Select BMP(s) that will be most effective in controlling pollution in the stormwater discharges, while being practical about resources and costs that will be required to implement and maintain those BMPs. . After you install selected BMPs, sample the stormwater discharges to verify reduced pollutants and determine if additional BMPs will be necessary to meet permit monitoring requirements for the various pollutants of concern. [Caution: The efficiencies provided in this document should be used as indicators of the potential pollutant reduction related to BMP installation. The efficiencies can be variable depending on a number of factors including flow, maintenance of BMP, loading and other factors.]

Low Impact Development began in Prince George’s County, Maryland in 1990 as an alternative approach to the no longer cost-effective detention ponds and basin on construction sites. The concept has become the preferred method of stormwater management because engineered small-scale hydrologic controls replicate pre-developed conditions through infiltration, filtration, storage, evaporating and detaining water close to its original source. Often space is a limiting factor for industrial facilities’ use of low-impact development controls. Other limitations include: soil conditions, climate, groundwater levels, cost and maintenance. DEQ promotes the use of low-impact development practices to reduce stormwater flows and control the mass load of pollutants that enter the receiving stream. In addition, if an industrial facility can capture and treat and/or infiltrate all stormwater without discharging to waters of the state or a conveyance system that discharges to waters of the state, that facility may be eligible for termination of NPDES permit coverage. Low-impact development options include:

- Bioretention Areas
- Dispersion or Swales
- Vegetated Roofs
- Permeable Pavements or Pavers
- Roof Rainwater Collection Systems (for re-use)

Underground Injection Control places fluids below the ground through dry wells, drill holes, soaking trenches and infiltration facilities with under drains. Any infiltration facility is a UIC if it is deeper than

Industrial Stormwater Best Management Practices

the facility is wide. Oregon Association of Clean Water Agencies hired Kennedy/Jenks Consultants to evaluate stormwater data before entering UIC devices. This report use data from five municipalities around Oregon, Clackamas County, Gresham, Redmond, Bend and Portland to provide DEQ with groundwater protectiveness models to demonstrate UICs do not pose a likely adverse risk to groundwater. This report and other factors reaffirm that injection systems to dispose of water that may come in contact with any raw material, product, byproduct or waste during manufacturing or processing may be a viable option while protecting groundwater under the Safe Drinking Water Act federally enacted in 1974. If all stormwater can be injected into the ground, permitting will be addressed through the underground injection control program and the facility may be exempt from NPDES permitting. All underground injection controls must be registered and approved for issuance through either a water pollution control facility (WPCF) permit or authorized by rule. Stormwater may be managed through underground injection systems provided conditions established in rule can be met. Some industrial activities which may inhibit use of groundwater injection include:

- Vehicle washing, maintenance, repair and recovery
- Airport de-icing
- Storage of treated lumber
- Facilities handling hazardous materials or improper storage and containment of chemicals
- Sites under Resource Conservation and Recovery Act (RCRA)

Best Management Practices

BMP 1 Coolant/Oil Recovery

Activity: Mechanical metal removal through the use of high-speed equipment and the associated discharge of metal fines in the form of swarf, grindings, chips, etc.



Typical Pollutants: Heavy metals, i.e. chromium, copper, manganese, lead, zinc; Dissolved Oxygen consuming organisms, i.e. bacteria, fungi; Chemicals in the coolant, i.e. corrosion inhibitors, emulsifiers, biocides, and etc.; Tramp oil; and Decreased pH.

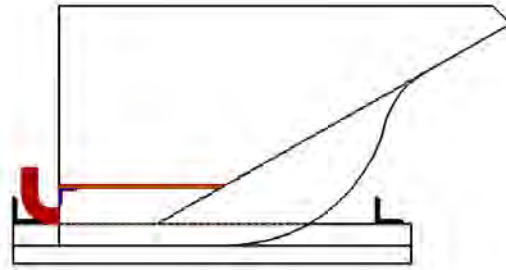
Typical Problem: Swarf and turnings are discharged into a hopper along with varying amounts of coolant and tramp oil. The hopper is transported outside and dumped into a dumpster or special portable scrap bin supplied by a scrap dealer. Typically the outside bin nor dumpster is not liquid proof nor is it covered. The coolants, metal fines, and tramp oil leak out of the outside bin or are spilled in the process of loading onto a transport vehicle. Quite often the discharge continues as the truck carries the scrap down the highway.

BMP: Locating the outside scrap bin on a concrete pad that drains into a dead-end containment sump and is bermed to prevent storm water run-on may resolve the potential source providing that the sump is emptied periodically. The sump should either be double contained or be coated on the inside with a flexible epoxy to minimize any seepage from any small cracks that may develop in the concrete sump. The trapped oil in the sump can be removed with a Belt Skipper similar to that shown on the right.



Industrial Stormwater Best Management Practices

Another approach that works is to modify the scrap hopper located at the metal removing machinery for coolant/oil separation from the swarf while the coolant/oil is warm and less viscous. This approach would minimize or eliminate leakage outdoors by removing most of the potential contaminants at the source.



A removable plate, either solid or with small perforations, either screened or unscreened, can be added to the bottom of the swarf/chip hopper. This creates a sump for the coolant and oils to drain into while the liquid is very hot and thus less viscous. A piping connection should be made into the lower chamber sized to fit the hose end on your sump sucker. If holes are made in the bottom plate, the number of holes will be determined with experimentation. They should be sufficient to provide the air draw of the sump sucker and should be located to encourage the best flow out of the lower chamber when the liquid is sucked out.



The same thing can be done with large scrap dumpsters. A Vacuum Truck would be needed to suck out all of the fluids from the large sump pipe.

Coolant should be of the synthetic type and should be recycled on site. Small package recycling units are available from several manufacturers.



A few manufacturers will modify existing hoppers or sell new hoppers that have a filtering

Industrial Stormwater Best Management Practices

screen and filter material separating the scrap from the liquid chamber.



Two commercially available bins with built in screening.

As the scrap bins are moved outside, pause at the outside door where someone should use a sump sucker to draw the liquid/fines out of the lower chamber for either proper disposal or recycling of the coolant.

Efficiency/Impact: Virtually all liquid and metal fines from this activity are prevented from entering the storm water drainage by implementation of this BMP provided the outside scrap dumpster/bin is covered when scrap from inside bins are not being discharged in to it. This point source should no longer be a significant contributor of pollutants to the storm water discharge.

BMP 2 Weld Fume Control

Activity: Metal cutting with gas burners, oxygen/acetylene torches, and welding of metal with stick, wire, or gas welders.

Typical Pollutants: Oily air emissions, metal particles; gaseous metal; and vaporized flux.



Typical Problem: The fume from the metal cutting/welding operation is exhausted to the outside where it comes in contact with rain and precipitates out into the storm water. Indoor air quality is also of concern.

BMP: Welding creates an oily soot type smoke. The amount of smoke produced from the welding process can be estimated using the table below.

Fume Ratio:

MIG (Wire Feed)	0.005-0.01	lb. of smoke/lb. of rod
TIG	0.004	lb. of smoke/lb. of rod
Oxy-acetylene torch	0.004	lb. of smoke/lb. of rod
Stick	0.015	lb. of smoke/lb. of rod
Flux core	0.02	lb. of smoke/lb. of rod

This fume has products that can be very small, submicron in size.

Industrial Stormwater Best Management Practices



There are several methods to control this fume. Centralized cartridge filtration systems like that shown on the left and portable HEPA filtration systems similar to that shown on the right are a couple of control methods in use today which appear to be phasing out electrostatic precipitator systems. Air extraction units with mist or charcoal filters can also be used.

Efficiency/Impact: Implementation of one of these BMPs will mostly eliminate this source of pollutants, not only to storm water but also to air, and significantly improve indoor air quality. As an added benefit, if the air inside of a building is heated, it may be possible to recycle the air and provide a significant energy cost savings in the winter months. This point source should no longer be a significant contributor to the storm water discharge concerns.

BMP 3 Drum & Container Containment

Activity: Oil (& other fluids) dispensing and outside storage

Typical Pollutants: Oil, hydraulic fluid, antifreeze, paint, solvent, cleaners, petroleum hydrocarbons, toluene, ethylene glycol, etc.



Typical Problem: Drums, pails, and small containers of liquids are stored outside in non-bermed, un-contained areas, which through expansion and contraction of the container, can damage the container, or the container bungs causing leaks, or filling/dispensing op-

Industrial Stormwater Best Management Practices

erations can discharge pollutants to the ground in the vicinity. Rain and snow contact this material and transport it off site or into the ground water.

Dispensing oil, antifreeze, and other potentially hazardous liquids may result in spills and leaks around the dispensing area. This leaked liquid can be tracked to other locations, or can seep through cracks and floor joints into the soil and groundwater beneath the floor. Rain and snow melt may transport these pollutants off site.

BMP: Portable metal storage buildings with built-in containment reduces this risk and better protects the liquid containers from damage and possible contamination. Environmental controls, i.e. heating and air conditioning, and fire protection are usually available in these pre-constructed units if needed.



If drums must be kept outside consider using cone shaped drum covers to keep water off the top of the drums

Industrial Stormwater Best Management Practices



Containment pallets made from steel or plastic will contain the liquid

When dispensing into secondary containers, the containment should drain into a drum or other container. Hoses on dispensing stations should not be able to extend beyond the containment area. For dispensing area containment, the volume of the containment area should be equal to the tank being dispensed from. If possible dispensing areas should be under roof or some other protection from stormwater. If a roof is not provided to keep out rain and snow, then the volume of the enclosure should be 110% of the volume of the largest bulk tank inside of the enclosure

Efficiency/Impact: Implementation of these BMPs will reduce the risk of exposure to stormwater of the contaminants associated with the delivery, dispensing, and storage of the materials in bulk tanks. Some risk of contamination will still exist from the material handling activities associated with moving containers of these liquids to and from the pallets or storage buildings or dispensing.

BMP 4 Tank Containment

Activity: Storage of liquids in bulk containers or tanks.



Typical Pollutants: Oils, diesel, gasoline (petroleum hydrocarbons); antifreeze (ethylene glycol); and solvents (toluene, mineral oil)

Typical Problem: Leakage or spillage occurs around tanks from filling, dispensing, and deterioration of pipe connections or failure of secondary containment

Industrial Stormwater Best Management Practices

BMP: Bulk storage tanks should have secondary containment in the form of a curbed enclosure with a liner to prevent migration of the liquids through the enclosure walls and floor. The liner can be in the form of a compatible flexible epoxy or a liner membrane compatible with the fluids being contained. If a roof is not provided to keep out rain and snow, then the volume of the enclosure should be 110% of the volume of the largest bulk tank inside of the enclosure. Fill locations should have drip trays that drain into a drum or other container. Dispensing areas should have their own containment. When dispensing into secondary containers, the containment should drain into a drum or other container. Hoses on dispensing stations should not be able to extend beyond the containment area. For dispensing area containment, the volume of the containment area should be equal to the tank being dispensed from. Dispensing areas should be under roof or some other protection from storm water. Caution should be used to ensure that incompatible materials are not contained within the same enclosure.

Double-walled, aboveground storage tanks maybe used instead of single walled storage tanks with containment structures. Filling and dispensing areas associated with double-walled tanks should have containment and protection from storm water.



Efficiency/Impact: Implementation of this BMP will reduce the risk of exposure to storm water of the contaminants associated with the delivery, dispensing, and storage of the materials in bulk tanks.

BMP 5 Metal Roof & Siding Coating, Gutter and Downspout Treatment

Activity: Runoff from buildings with corrugated galvanized sheet metal roofs and/or siding and gutter and downspouts

Typical Pollutants: Zinc & Iron

Typical Problem: As the sheet metal ages zinc from the galvanized coating is released to storm water runoff. If the loose of zinc continues for too long then, iron will also show up in the storm water discharge and eventually the roof or siding will have to be replaced rather than be repaired.

BMP: Avoid using galvanized sheeting on new construction. Clean and paint the exposed galvanized sheet with good enamel paint. Be sure to contain and collect any liquids used in cleaning for proper disposal. Instigate a regular inspection and maintenance program concerning the building painting.

Industrial Stormwater Best Management Practices



Downspout Treatment



Painted Siding and Roof

Efficiency/Impact: With proper maintenance of the painted surface the zinc and iron in runoff can be decreased from this source to the non-detect level. Periodic recharging of or replacement of the filter media will significantly reduce the zinc and iron levels in the downspout runoff (see page 23 for some of the possible pollutant reductions obtainable).

BMP 6 Biological Based Parts Cleaners

Activity: Cleaning of parts and equipment in parts cleaners containing mineral spirits/oil or petroleum products.

Typical Pollutants: Petroleum hydrocarbons

Typical Problem: The use of petroleum based cleaners leads to the requirement for either storage of the spent cleaner or recycling companies periodically removing old cleaner solution/sludge and adding new solution. This results in spent cleaner storage on site and/or frequent handling of both the clean and contaminated cleaner. This increases the risk of spills and leakage getting into storm water. The spent cleaning solution/sludge must be treated as a hazardous waste and be properly handled and disposed.

BMP: Large parts and frames are generally cleaned in a shot blast machine. Smaller parts should be cleaned in an aqueous based solution (caustic or other) or in a biological solution. These units typically are heated and may involve agitation. Parts cleaners other than these typically have a sludge residue or the solution has to be replaced periodically. The sludge or removed solution is usually considered a hazardous waste somewhere in its cycle. The sludge from an aqueous based or biological parts washer is not typically hazardous and solutions are only added, never removed.

Industrial Stormwater Best Management Practices



There are now many manufacturers and suppliers of Biological Parts Washers.

Efficiency/Impact: Use of water based or biological parts cleaning solutions could potentially result in no hazardous waste generation, improved health for employees, and overall cost savings in material, labor, and waste disposal. Generally, cleaning with these solutions takes employee involvement in the acceptance of the use of the material and usually takes a little bit longer to perform the cleaning operation.

BMP 7 Lined Grease Containers

Activity: Vehicle maintenance, equipment maintenance, and construction involving the addition of grease to joints, couplings, bearings, etc.

Typical Pollutants: Grease (Petroleum Hydrocarbons with heavy metal additives)

Typical Problem: Grease containers when emptied still contain fair amounts of grease residue in them. Should water mix with this grease, potential adverse impact to the environment in the form of oil/water spillage may occur.

BMP: Some suppliers provide returnable containers (bulk) that, when sealed after use, minimize the potential adverse impact. Another environment friendly option is a container that is lined. After emptying, the liners can be removed and more of the grease squeezed out. The liners can then be placed in a drum for accumulation and properly disposed.



Efficiency/Impact: An increase in the amount of grease available at very little increase in labor cost will result from implementation of this BMP. If the lined containers are used, properly accumulated and disposed of after use or bulk returnable containers are used, very little risk of environmental contamination through storm water dis-

Industrial Stormwater Best Management Practices

charges will be present from this source.

BMP 8 Vehicle, Pavement and Building Washing

Activity: Pressure washing or steam cleaning of equipment, outdoor surfaces and/or vehicles. Under the 1200-Z Industrial Stormwater Permit authorized non-stormwater discharges include: Pavement washing where no detergents or hot water are used, no spills or leaks of toxic or hazardous materials have occurred (unless all spill material has been removed), and surfaces are swept prior to washing. In addition, vehicle washing without use of detergent or hot water is authorized depending upon the volume of weekly washing and discharge point. Additional controls and/or DEQ permits will be needed if using heated water, acids, bases, metal brighteners or conduct engine washing.

Typical Pollutants: Degreasers, organics, heavy metals, oil and grease and pollutants from soap, such as, phosphate and nitrogen

Typical Problem: When equipment and/or vehicles are washed outside, contaminants in the wash-water and the overspray mix with the stormwater runoff.

BMP: Ideally wash areas should be located on well-constructed and maintained, impervious surfaces with drains piped to the sanitary sewer. The wash area should extend at least 4 feet in every direction from the perimeter of the vehicle or equipment being washed. When sanitary sewer is not available there are several different approaches that can be taken depending on the size of the site and the resources available, (although permits may be required) such as:

- discharging the storm water to a properly sized grassy swale or constructed wetland,
- discharging the washwater and storm water to a collection sump for later disposal,



- discharging the storm water through an oil/water separator,
- provide a package recirculation/treatment system for washing
- relocating the washing operations to a commercial washing facility,
- contract with a mobile washer to wash the vehicles and ensure that they capture and remove the liquid and solids and properly dispose of them, and/or
- perform the washing activities off site at a commercial vehicle wash facility.

Industrial Stormwater Best Management Practices

- The use of organic solvents or non-biodegradable chemicals, soaps and detergents is prohibited.

Selection of the cleaning detergent is critical if oil/water separation unit is used. Ensure that the detergents used do not emulsify oils as this would allow the oils and grease to flow through the oil/water separator instead of being separated from the effluent. The detergent must be a low sudsing, phosphate-free, biodegradable type. Design the cleaning area with walls to keep the dirty overspray from leaving the wash area.

Commercial Alternatives:

- Hire a commercial mobile washer. These units are capable and must collect all water and solvents, therefore, are less restricted on use of acids or brighteners, engine cleaning or high pressure washing.
- Relocating the washing operations to a commercial washing facility.

Additional Source Controls:

1. All wash water runoff should be drained away from a shop area or chemical storage facility.
2. Cleaning operations should be modified to minimize paint residues (chips), heavy metals, or any other potentially hazardous materials that detach from surfaces. Modifications such as, change of cleaning agent or reduction in water pressure. Detached particles should not enter storm sewers or surface waters but rather collected for proper disposal.
3. The use of acids and/or solvents as cleaning agents for building exteriors and pavement areas is not allowed. Dry or semi-dry methods may be used to clean these surfaces (i.e., sand or other particle blasting, grind-off and vacuum technology, and ice blast technology). If blasting is used as an alternative, all solids should be swept or vacuumed and disposed of properly.
4. Facilities that conduct engine washing, acid/caustic/metal brightener washing, or steam/heated water washing shall conduct all operations on an impermeable surface. This wash water must be collected and treated prior to discharge and a Wash Water Permit is required.

Sanitary Sewer Discharge

1. Prior to disposal of wash water to sanitary sewer, minimum effluent limits must be met as required by the local Sewer Authority. It is the facility's responsibility to meet all discharge conditions before using the sanitary sewer. There are no DEQ permitting requirements if all wash water is authorized and routed into the sanitary sewer.
2. If pretreatment units are necessary they should be operated and maintained in accordance with manufacturer specifications and as required by the local Sewer Authority.

Disposal alternatives to ensure contaminated water does not enter surface waters are as follow:

1. Wash water may be collected in a sump, grit trap, or containment structure to be pumped or si-

Industrial Stormwater Best Management Practices

phoned to a vegetated area so that complete percolation into the ground occurs. An impermeable fabric liner may be needed for the lagoons or constructed wetlands to protect groundwater. All criteria set forth in OAR 340-40 must be met for groundwater quality protection. Treatment options include, but are not limited to:

- grit trap for suspended solids removal
- oil/water separator removes floating oil
- ph adjust unit will neutralize acids and caustics
- advance treatment alternatives

➤ The treatment system must be, at all times, properly operated and maintained. Records of maintenance activities should be maintained on-site for DEQ inspection.

2. Disposal of wash water should occur on ground surfaces with vegetated cover and may not cause any erosion. Depending on the amount of vehicles washed in a week, a permit may be required.

3. If facility is close to surface waters the wash water may be disposed to a dry grassy swale, a minimum of 250 feet in length before the waterbody. Complete percolation in the swale should occur with no direct discharge to the surface water. Discharge into a grassy swale for treatment should not occur within 24 hours after a rainfall event or if water remains ponded in the swale. A distance of 250 feet was based on a hydraulic conductivity of 0.2 gal/ft/day, volume per day of 150 gallons, and a swale with a width of 3 feet.

Efficiency/Impact: The use of a recycling system will not only reduce or eliminate the contaminant discharge to stormwater or sanitary sewer but it will greatly reduce the amount of water used in the process. The use of a bioswale with an oil/water separator will likewise virtually eliminate the total suspended solids, oil and grease, and heavy metals discharged provided both are properly sized. A portable collection system will provide the collection of the contaminants provided the collection system is large enough to capture significant amounts of the overspray.

BMP 9 Oil/Water Separators

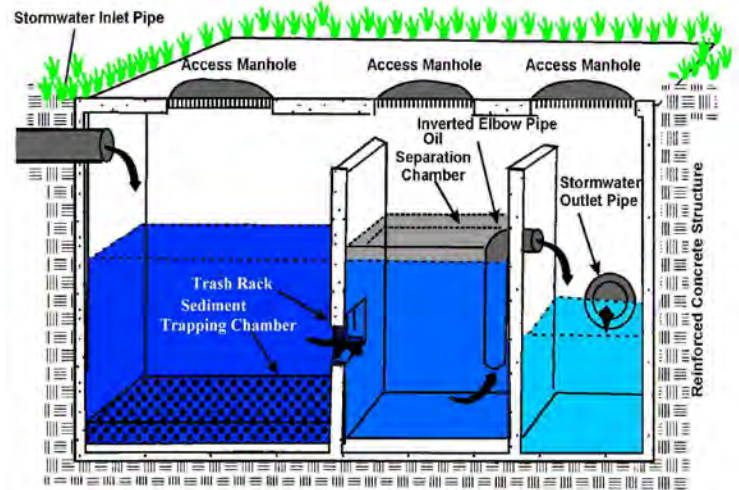
Activity: Any site that has steel, equipment or vehicles stored outside and has a potential for oily storm water discharges.

Typical Pollutants: Oil and grease, PAH, and suspended solids

Typical Problem: Structural steel and plate arrives on the site from the supplier coated with oil to inhibit corrosion. As storm water comes in contact with the steel the oil disperses and runs off. Equipment stored outside has grease and oil on it that washes off when contacted by storm water. Vehicles not only have the normal oil and grease associated with them but they also have road film which contains oil.

Industrial Stormwater Best Management Practices

BMP: Installation of a properly sized oil/water separator can reduce the amount of both Total Suspended Solids and Oil and Grease in the storm water run-off. Several types of oil/water separators are available (Gravity, Coalescing, Centrifugal, Carbon Absorption, Ultrafiltration, etc.). Gravity Oil/Water Separators are generally the most economical provided emulsifying chemicals have not been used upstream of the separator, dirt is not a major contaminant, and high shear centrifugal pumps are not used to pump the water to the separator.



There are three basic types of oil/water separators, spill control (SC), API (longer retaining time), and coalescing plate (CPS) recommended for use in all pipe drainage systems conveying runoff from paved areas, subject to vehicular use or storage of chemicals, prior to discharge from the project site or into an open drainage feature. All three types have the following basic application/selection criteria:

- Urban residential runoff usually low flows
- Suitable for smaller sites, draining 5 or less acres
- Land uses associated with include: industrial, transportation, log storage, airports, fleet yard, railroad, gas station, vehicle/equipment dealers and repair, construction and petroleum storage.
- SC can be effective at retaining small spills but does not remove dispersed oil droplets because they have a short residence time. SC type should be required when the site stores petroleum based products and spills are likely.

API used where there is a relatively high likelihood of dispersed oil contamination. API/CPS should be used in areas with high traffic volumes (2,500 vehicles per day), at sites that are used for petroleum storage/transfer, scrap and wrecking yards, or at sites where heavy equipment is stored and/or maintained. Oil/water separators cannot deal well with heavy sediment loads and should be used in conjunction with detention, biofiltration, or water quality treatment system to protect groundwater. CPS consist of a bundle of plates made of fiberglass or polypropylene installed in a concrete vault. The plates improve the removal of oil and fine suspended sediments and assist in concentrating the pollutants for removal. CPS requires frequent inspection and maintenance to operate as designed. A mechanism should exist for the system to be bypassed, so the system can be taken off line for maintenance. Oil and sediment removed from devices may qualify as hazardous waste and should be tested prior to disposal. Oil separators should be sized for a local six-month reoccurring 24-hour design storm. Larger storms should be diverted from the separators.

Efficiency/Impact: The use of gravity oil/water separators in the storm water outflow can greatly reduce the free oil droplets larger than 0.015cm (150 microns). Ultrafiltration can virtually eliminate oil in the storm water outflow. Fouling of membranes may be

Industrial Stormwater Best Management Practices

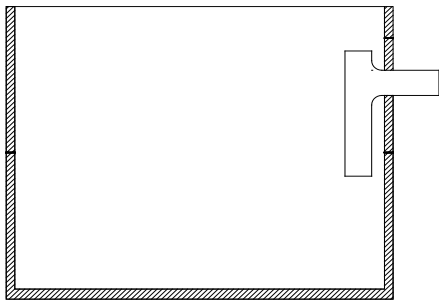
come a concern with Ultrafiltration although some newer vibrating membranes show great promise for keeping the membranes clear during backflushing.

BMP 10 Oil/Water Separators for Air Compressors

Activity: The use of compressed air.

Typical Pollutants: Oil

Typical Problem: Compressed air systems typically absorb or condense moisture from the ambient air. Fine oil is released to the compressed air in the compression cycle. The condensed water is either manually drained out of the compressor, filters, and/or the air receiver tank or is automatically drained by a timed valve system. This condensate may be discharged to the ground or to a location that can leak or be spilled into the outside environment. Storm water then flushes this oil to the storm water outfall.



BMP: Install an oil/water separator especially made for compressors and receiver tanks or manufacture a simple separator similar to the one shown on the following page and siphon off the oil. Discharge the remaining water to the sanitary sewer if it is available on-site.

Efficiency/Impact: Oil from this source can be greatly reduced or eliminated and loading to the storm water conveyances will be reduced.

BMP 11 Oil and Sediment Trap Catch Basins

Activity: Storm water runoff from commercial or industrial sites to standard catch basins or drains.

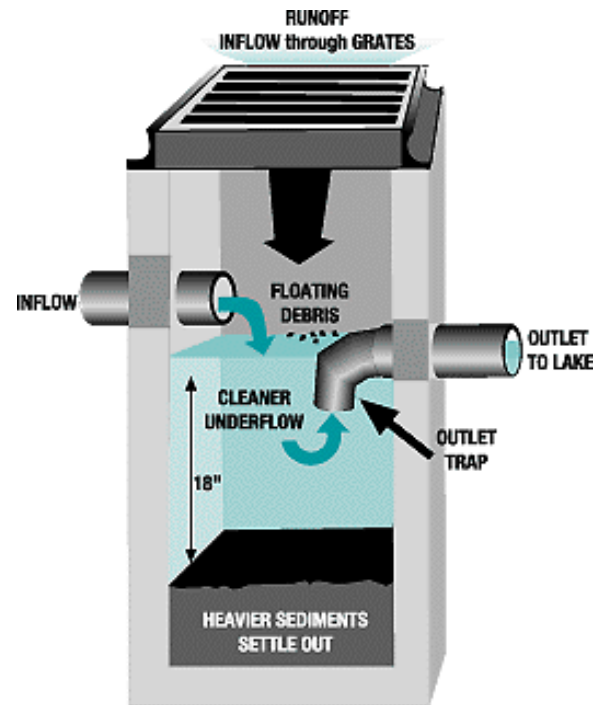
Typical Pollutants: Oil, PAH, and sediment

Typical Problem: On sites that use standard catch basins or drains there is no retention of any oils or sediments. This could result in excessive discharges to storm water of these pollutants.

Industrial Stormwater Best Management Practices

BMP: Retrofitting drains to standard sediment and oil trap (Lynch style) catch basins properly designed for the flow-through rate and when properly maintained can reduce oil and grease levels in the storm water discharge significantly.

Efficiency/Impact: Proper sizing and maintenance can reduce the discharge concentrations of oil and grease to below 10mg/l and suspended solids including heavy metals by from 10% to 42% depending on the influent flow rate and the accumulated sediment level already in the lower sump with the lower efficiency corresponding to the higher flow rates. It is extremely important to remove the accumulated sediments and oil in the catch basin when the sediment retention capacity (depth below the bottom of the outfall pipe) is reduced by 50 % but to a depth of not less than 18 inches to the outfall pipe.



Note: An additional issue on some industrial sites is the lack of a single or common sampling point which may require that sampling be accomplished from the catch basin(s). The catch basin is typically the worst place to sample in that it is where the pollutants are concentrated and retained and it is not really representative of the pollutant concentrations leaving the site. Sometimes an insert bag may be used in the catch basin as a BMP to remove sediments. Moving this bag to the side typically re-suspends TSS that was clinging to the bag thus increasing the TSS in the samples collected. Consider using a pipe Tee instead of an inverted elbow or flat steel invert/cleanout in the catch basin outfall. If the pipe and tee are four inches or more in diameter, it is possible to dip the sample bottle in the clean side of the catch basin and if the tee were extended up through the grate and a removable cap was placed upon it, the insert bag would not have to be disturbed nor would the grate have to be removed in order to sample. Another option for sampling is to excavate to the outfall piping on the discharge side of the catch basin and replace a section of the 45 degree angled drain pipe with a sampling sump with access to a sealed cover at ground level. The depth to the angled outfall pipe would probably be around 18 inches or less in most cases.

Industrial Stormwater Best Management Practices

BMP 12 Containers for Dust Collectors

Activity: Arc furnace or mechanical removal operations (grinding, sanding, shot blasting, etc.) that create dust which is collected in baghouses.

Typical Pollutants: Metal fines, suspended solids in storm water

Typical Problem: Mechanical removal operations involving the removal of metal, paint, wood, and other materials generate dust that is collected in bag filter houses. Arc furnaces will generate a metallic fume that condenses out as a dust on the way to the baghouse. The baghouses must discharge the dust collected to a dumpster, drum, or bin. If the connection between the baghouse and the collection container is not airtight then, dust leaks out into the environment. Storm water will contact this dust and convey it off-site, typically causing a TSS discharge problem.



BMP: If a drum is being used for collection of the dust, manufacture from a removable drum top a flange or sleeve that a flexible boot can be clamped to and attach the sleeve to both the discharge point on the baghouse and to the drum sleeve. Use quick release clamps to attach the removable drum top to the drum. If a dumpster or other large container is used to collect the dust, manufacture a solid reinforced cover for the container using rubber sealing strips and

Industrial Stormwater Best Management Practices

clamps or bolts to hold the cover in place. The cover should have a sleeve or flange that attaches to a flexible boot which is attached to the discharge point on the baghouse. It may be necessary to also include a vent line from the dust receiving container back into the dust collector in order to relieve the air pressure resulting from the dust dropping down in to the collection container.

Spillage that occurs from connecting and disconnecting to the flexible boot should be immediately cleaned up using a vacuum. A fixed vacuum duct may be plumbed into the inlet of the dust collector with a valve so that the spillage can be reintroduced into the dust collector. Also, frequent vacuum sweeping of the area around the dust collector should be performed.

Efficiency/Impact: Through the use and proper maintenance of the container covers most of the dust can be contained significantly reducing the amount of dust that could leak out to the environment. This would, in turn, greatly reduce the impact from this source of suspended solids and metals to the storm water discharge.

BMP 13 Ozone Generators for Cooling Towers

Activity: The use of cooling towers with the associated water treatment chemicals and blowdown discharges.

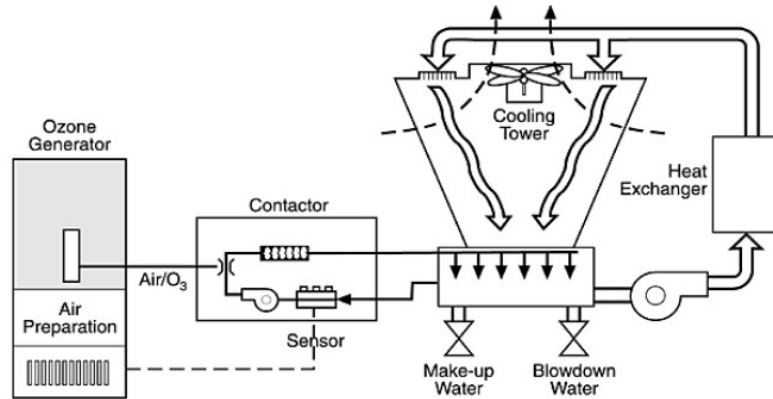
Typical Pollutants: Biocides, algacides, fungicides, and corrosion inhibitors (BOD, COD); suspended solids; zinc; and copper



Typical Problem: Chemicals such as Biocides, Algacides, and Corrosion Inhibitors are added to cooling towers to prevent biological growth and to reduce scaling and corrosion. Periodically cooling tower water must be blown down in order to remove sediment and particulate buildup in the cooling tower sump. This water should be discharged to sanitary sewer but may not be in areas where a sanitary sewer is not available. Even when the water is discharged to a sanitary sewer an upset can occur in which the cooling tower sump water is discharged to outside areas and comes in contact with storm water. This water can contain elevated levels of copper, zinc, and chemicals with high BOD₅ and COD.

BMP: Use ozone instead of chemicals to control biological growth and scaling. Ozone is a powerful oxidizing agent. It has one and one-half times the oxidizing potential of chlorine. A properly operated and controlled ozone treatment system will not allow microorganisms that secrete the glue-like substance called mucilage to survive and will break down existing mucilage. Microbiological induced corrosion (MIC) can be controlled through the use of ozone. The pH of the water when using ozone is around 8 in comparison to levels typically below 7 when using chemical treatment. Cooling tower sumps can be vacuumed out using a swimming pool type vacuum. With little or no biological growth, the absence of chemical additives, and the absence of scaling sediment, particulate accumulation can be restricted to airborne particulates for the most part which should reduce the frequency for the need to remove sediments and particulates by blowing down the sump. Use of a swimming pool vacuum cleaner could eliminate almost all blowdown.

Industrial Stormwater Best Management Practices

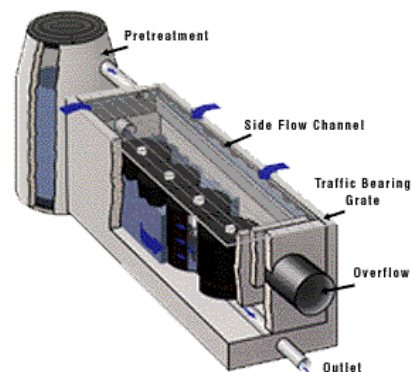
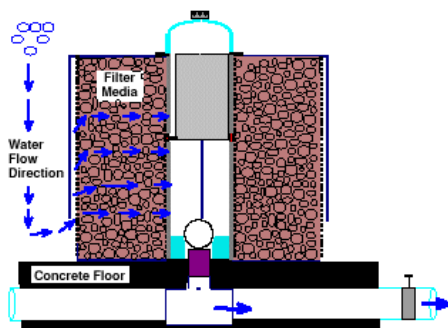


An alternative to introducing ozone is the use of ultraviolet light disinfection to control microbial growth in cooling tower water. In this case the cooling tower is recirculated through the UV unit which kills organisms attempting to grow in the water. Blowdown will still have to occur but will probably be required at a reduced frequency over that necessary when chemicals are used. The computer chip industry has used this method for their ultrapure water processes for years and the machinery coolant recycling equipment industry has also been using UV treatment units to eliminated biological growth in their coolant recycling equipment.

Efficiency/Impact: By replacing chemical additives with ozone or UV treatment and using a swimming pool vacuum cleaner for sediment removal, potential pollutants from this source to the storm water conveyances can be reduced or eliminated.

BMP 14 Cartridge Filtration

Activity: Operations with exposed copper and/or galvanized piping, galvanized siding and/or roofing materials, cathodic protection coatings of copper such as may be found on boats, or other exposed copper, brass, and/or zinc coated materials that are exposed to storm water may have significant levels of these metals present in their storm water discharge. Operations involving heavy vehicle traffic may also have metals in their storm water discharge such as copper from brake shoes and clutches or zinc from tire wear.



Vault type filters

Industrial Stormwater Best Management Practices

Typical Pollutants: Copper, zinc, PAH, and Total Suspended Solids

Typical Problem: Dust from tires (1% Zinc wear rate = 90mg/km/tire) and clutch/brake mechanisms, deterioration from galvanized building materials or corrosion and/or oxidation of copper piping and fixtures cause discharges of particulate and dissolved chemical forms of copper and zinc to the environment when contacted by storm water. Copper based cathodic protection on boats and other equipment generates chemical and particulate forms of copper that becomes combined with storm water.

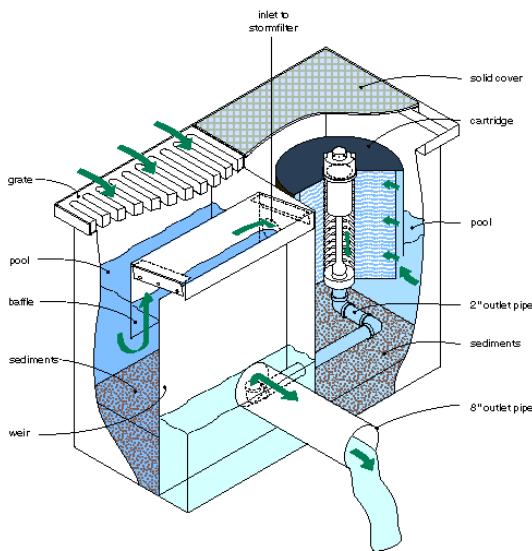
BMP: The installation of properly sized compost filtration units can remove significant amounts of both chemical and particulate forms of some heavy metals, including copper and zinc, and reduce TSS levels in the storm water discharge. Colloidal particulate levels from clay soils should also be reduced effectively.

Effectiveness/Impact: Evaluation of existing sites over a three-year period show that the mean reductions of pollutants in storm water for the following were achieved:

For Compost Media

TDS	22.4%	Turbidity	91.8%
COD	70.4%	Total Phosphorus	44.9%
Lead	44.9%	Zinc	83.2%
Copper	65.3%	Oil & Grease	80.9%

In general, reductions for Heavy Metals can be expected to be in the range of 65 to 95% and for Oil & Grease up to 85% for a properly designed and sized system.



Catch Basin type filter



Roof Downspout type filter

Industrial Stormwater Best Management Practices

BMP 15 Sweeping

Activity: Operations that have exposed copper and/or galvanized piping, galvanized siding and/or roofing materials, or other exposed copper, brass, and/or zinc coated materials exposed to storm water can have significant levels of these metals present in the storm water discharge. Operations involving heavy vehicle traffic also produce elevated metal levels in storm water from vehicle brake shoes or clutches (copper) and tire particles (1% zinc wear rate = 90mg/km/tire).

Typical Pollutants: Total Suspended Solids, PAH, Copper, Zinc.

Typical Problem: Dust from tires and clutch or brake mechanisms, deterioration from galvanized building materials, or corrosion and/or oxidation of copper piping and fixtures cause discharges of particulate and dissolved chemical forms of copper and zinc to the environment when contacted by storm water. Copper based cathodic protection on boats and other equipment also generate dissolved chemical and particulate forms of copper that can become combined with storm water.



BMP: Sweeping of paved roads, parking lots, and storage areas with a type of vacuum sweeper that incorporates HEPA filtration or other high efficiency method of filtration of the exhaust air from the sweeper to trap the very fine metallic particles found in road or parking lot dust can reduce these discharges to storm water.



Ensure that good control measures are implemented when dumping the contents of the sweeper and practice proper disposal methods for the emptied contents to ensure that there is no adverse environmental impact after spending so much effort in the initial clean-up.

Industrial Stormwater Best Management Practices

Efficiency/Impact: This type of Sweeper is capable of collecting and containing up to 99.6% of particles as small as 2.5 microns in size. The elimination of particulates in storm water is related to the frequency of sweeping as is shown comparisons of various types of sweepers in the following graph.

There are sweeper certifications, PM-10 and AQMD, which both are high efficiency sweepers that can contain small particle sizes. Some models, as shown below, contain hoppers which can be emptied directly into a dumpster or dump and debris as it is picked up from the floor and passed through a polyester filter. When the hopper is full, it can be emptied directly into a dumpster or dump truck, minimizing the chance of particulate matter being re-released into the air. Information from the manufacturer, reports that the sweepers will retain particles 10 microns, or 0.001 mm, or larger. The smaller size of the model and four-wheel steering makes it easy to maneuver in small spaces that traditional sweepers would not fit.

BMP 16 Battery Storage



Activity: The outdoor replacement or storage of lead/acid or nickel/cadmium batteries and the long time storage of vehicles or battery powered equipment outside.

Typical Pollutants: Soluble metals such as lead, nickel, or cadmium, Sulfuric acid

Typical Problem: When batteries are replaced, the used batteries are generally stored around a site until enough have been collected to make it feasible to either have them picked up or shipped out to a battery recycler. These batteries are usually stored on the shop floor or outside without containment and with no thought of exposure to storm water. Sometimes electric lift trucks, pallet jacks, welders, portable powered pumps, etc. are stored outside with the batteries used for starting or for operation left in place and poorly protected from storm water contact. Lead sulfate usually present on lead/acid batteries or in the spillage of the lead/acid or nickel-cadmium/acid solution can create soil contamination and a storm water run-off problem.

Industrial Stormwater Best Management Practices

BMP: Batteries should be stored in a contained area protected from the weather. Containment pallets can be used to collect any acid spillage. The pallets should be placed inside of buildings to keep storm water from coming into contact with the batteries.



Efficiency/Impact: Containment, protection from the weather, and frequent shipment to the recycler can minimize or eliminate the adverse storm water impact from this potential source of contamination.

BMP 17 Wrecked Vehicle Storage & Scrap Metal Recycling



Activity: Wrecked or Damaged Vehicle Storage or Scrap Metal Recycling

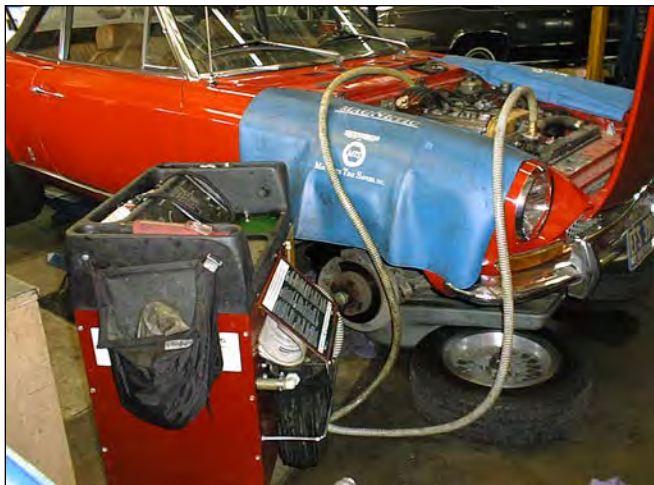
Typical Pollutants: Antifreeze (ethylene glycol), gasoline, oil, grease, brake fluid, diesel

Industrial Stormwater Best Management Practices



Typical Problem: Depending on the damage to the vehicle, fluids may leak due to the damage incurred and/or the damage may expose oily components of the vehicle that would normally be protected from the weather. Storm water will contact these contaminants and infiltrate the ground, contaminating the soil and groundwater at the site and combining with storm water runoff, depending on the rainfall and soil conditions, to waters of the State.

BMP: Provide containment of wrecked vehicles on impervious surfaces. If wrecked vehicles are stored on impervious surfaces, the drainage from those surfaces should pass through an oil/water separator prior to discharging to a storm water drainage system or to a storm water sewer. Insure that all fluids are completely drained from wrecked vehicles. If possible, provide a roofed storage area to prevent storm water contact with wrecked or damaged vehicles.



Fluid Vacuum Extraction System



Fluid Vacuum Drill System

Remove engine oil, transmission fluid, rear-end oil, antifreeze, Freon, and any other fluids before storing the vehicles on the site.

Industrial Stormwater Best Management Practices



Fluid Gravity Drain System

Efficiency/Impact: Storage of all vehicles under a roof with a storm water divergence berm should, by eliminating storm water contact and allowing collection of potential contaminants, eliminate storm water concerns. Providing an impervious surface for the vehicles should eliminate the concern for groundwater contamination. Draining of the vehicle fluids would minimize but not eliminate the contaminant(s) concern.

BMP 18 Paint Stripping

Activity: Stripping coatings (paint, plastic, etc.) from metal and wood surfaces outdoors.

Typical Pollutants: Hazardous stripping chemicals, lead from old lead based paints, zinc chromate from old paint preparations, metal particulate, low pH, and increased suspended solids

Typical Problem: Stripping of wood and metal parts is usually accomplished with the use of chemicals that have health and environmental hazards. High pressure water blasting can cause increased runoff and can, in the case of blasting wood, damage the surface. Sand blasting creates a large amount of solids to dispose, i.e. the sand plus the paint removed which may be considered hazardous waste.



BMP: Consider using dry ice or baking soda abrasion type removal of old surface coatings instead of chemical or sand blasting. The dry ice system removes the surface

Industrial Stormwater Best Management Practices

coating and leaves only the material removed on the ground, which can be vacuumed or swept up. Using baking soda as the blasting agent leaves the material removed plus baking soda which is not typically harmful and can be fairly easily separated from the paint removed with it by using reclamation equipment or through dissolving the baking soda in water and separating the paint by sedimentation and then evaporating the water. Use a removable ground cover before blasting to ease the cleanup efforts at job completion.



Another consideration is the use of a temporary or portable structure to contain and isolate the work and debris from the stripping from contact with storm water runoff such as the temporary structure on the left used to protect a boat during hull stripping.

Efficiency/Impact: By placing a removable ground cover such as a plastic tarp down prior to conducting the work and using one of the blasting methods mentioned or building a temporary structure, virtually all of the removed material can easily be cleaned up with minimal volumes of material involved. Disposal will be less costly when less volume of combined materials are involved over the conventional sand blasting methods. The overall impact to the environment and especially to storm water discharges will be minimized or eliminated.

BMP 19 Equipment Covers

Activity: Storage of used or new equipment outside exposed to rain and snow fall.

Typical Pollutants: Metals, TSS, Oil & Grease



Typical Problem: During the removal and installation of production or facilities equipment, the equipment is typically stored outside exposed to the elements for short durations in the case of new equipment being installed or for longer duration for equipment removed from service. This may allow rainwater or snow melt to wash oil and grease along with metal solids into the stormwater runoff.

Industrial Stormwater Best Management Practices

BMP: Obtain tarps or plastic sheeting and wood bracing or pallets in the case of used equipment to keep the equipment above the surface water runoff and to eliminate the exposure of the equipment to rainfall and snowfall. The tarps or sheeting must be securely anchored to minimize the maintenance activities that may be needed to keep the protection in place.

Efficiency/Impact: Except for the times that the equipment is being placed in the buildings or unloaded/loaded on trucks for shipping this source of contaminants should be able to be eliminated.

BMP 20 Brake Shoe Replacement

Activity: Vehicle repair/brake shoe replacement including materials handling vehicles.

Typical Pollutants: Asbestos, copper, total suspended solids



Typical Problem: Dust in the brake shoe/wheel housing is typically disturbed and can be released into the environment when brake shoes are replaced. This dust will migrate from inside buildings to outside areas creating an asbestos and/or increased copper discharge when contacted by storm water.

BMP: Use the Low Pressure/Wet Cleaning Method described below for dust removal in brake shoe housings. Some older brake shoes may still be present which contain asbestos. Some new brake shoes on mobile equipment still contain asbestos. Brake shoes contain copper compounds in addition to other materials. The dust in the brake shoe housing can, because of its micron and sub-micron size, escape the shop area and contaminate the site to a level that, when contacted by storm water, may exceed the copper discharge benchmark. If a vacuum is used, ensure that it is of a type that has a HEPA filtration system that can retain the micron sized particles.

Low Pressure/Wet Cleaning Method

- A drip pan shall be placed under the brake assembly, positioned to avoid splashes and spills.
- The reservoir shall contain water containing an organic solvent or wetting agent. The flow of liquid shall be controlled such that the brake assembly is gently flooded to prevent the asbestos-containing brake dust from becoming airborne.
- The aqueous solution shall be allowed to flow between the brake drum and brake support before the drum is removed.
- After removing the brake drum, the wheel hub and back of the brake assembly shall be thoroughly wetted to suppress dust.
- The brake support plate, brake shoes and brake components used to attach the brake shoes shall be thoroughly washed before removing the old shoes.

Industrial Stormwater Best Management Practices

- In systems using filters, the filters, when full, shall be first wetted with a fine mist of water, then removed and placed immediately in an impermeable container, properly labeled and disposed.
- Any spills of asbestos-containing aqueous solution or any asbestos-containing waste material shall be cleaned up immediately and properly disposed.
- The use of dry brushing during low pressure/wet cleaning operations is prohibited.

Efficiency/Impact: Use of the wet method for removing the dust in the wheel/brake housing or the use of a HEPA vacuum will significantly reduce or eliminate this practice as a source for copper or asbestos in storm water. It will also significantly reduce the potential health hazard associated with asbestos exposure to employees.

BMP 21 Employee Environmental Training

Activity: Employee environmental education and training.

Typical Pollutants: All



Typical Problem: Many employees are not aware of the potential adverse impact the company's business may have on the environment or how they personally can affect those impacts. They may not have even thought about environmental impacts and cannot recognize bad practices. Some may not know whom to inform of upsets or potential problems.

BMP: Provide periodic training that describes the potential adverse environmental impacts of the business and methods for preventing those impacts. The training should:

- Describe how the company is being environmentally responsible.
- Encourage employees to bring forth suggestions for improving the environmental performance of the business.
- Describe how and to whom the employee should report potential environmentally related concerns.
- Inform the employee of what to do.
- Provide incentives to employees to offer ideas for improvement.

Record attendance of the training. Show graphics in the presentation such as pictures of the various parts of the site under discussion during the presentation. Schedule regular inspections of the site looking for possible conditions or operations that could produce potential adverse environmental impacts. Use a team approach to this inspection, as it is too easy, even for professionals, to acquire tunnel vision during the inspection. During the site inspections, write up every questionable item or practice for later thought or resolution. To resolve or dismiss a suggestion or

Industrial Stormwater Best Management Practices

question during the inspection may distract from the process of the inspection or discourage employees from providing their input. Do not associate biodegradable with environmentally safe. Verify that the company is not moving wastes from one media to another, i.e. water to air, storm water to groundwater, etc.

Before the training takes place, analyze the potential problem areas of the site and the potential for how the site's manufacturing process can adversely impact the environment. Develop the training program presentation around these areas. Ask the question "what message am I trying to present?" and thoroughly provide the information necessary to answer the question. How and to whom should it be reported? Involve employees in the presentation through discussion items. Don't over look providing this training to temporary employees.

Efficiency/Impact: By making employees aware of the potential adverse impacts of the business and encouraging employees to offer ideas and suggestions, employers will see, not only a decrease in pollutants in their storm water discharge but, potentially in air, hazardous waste, and other media.

BMP 22 Housekeeping



Activity: Any site that stores material outside.

Typical Pollutants: Total suspended solids from erosion, oil and grease, BOD₅, heavy metals.

Typical Problem: Poor housekeeping inside and outside on a site provide a possible indicator of the degree of the site's compliance with environmental, health and safety regulations. In addition, poor outside housekeeping tends to discharge paper, cardboard, wood, pallet and box strapping, and other wastes to the storm water conveyance system. These wastes can plug the storm water conveyances, and divert storm water flows causing increased erosion and localized flooding.

Industrial Stormwater Best Management Practices

BMP: Good housekeeping includes:

- Orderly storage of bags, drums, and piles of materials and chemicals; prompt cleanup of spilled liquids;
- Frequent sweeping, vacuuming, or other cleanup methods for accumulated dry chemicals and materials can cut down on possible storm water contamination;
- Proper disposal of toxic and hazardous wastes, and
- Removal of accumulated scrap and spare parts.

Good housekeeping doesn't just happen. It occurs when it is well planned, scheduled, and when upper management demonstrates its importance by participating in regular inspections. Set aside time in the work schedule for cleanup activities.

- Schedule personnel to be responsible for the cleanup and rotate every employee through the schedule.
- Periodic inspections and regular site cleanup can prevent problems from occurring. The frequency of outside inspections should be increased during the October through May rainy period.
- Encourage employees to pick up trash when it is seen and to report when more intensive clean up is needed.

Every site that is environmentally responsible has good housekeeping activities. Most sites with environmental problems do not have good housekeeping activities.

Efficiency/Impact: The implementation of a formal housekeeping program with education and encouragement of employees can reduce or eliminate pollution by bringing the importance of how materials are stored and how trash can affect the storm water discharges to their attention along with the importance that management places on the issue. A regular maintenance schedule for storm water conveyances minimizes erosion and visually verifies the condition of the storm water discharges. Several typical pollutants in storm water can readily be identified by visual observance.

Industrial Stormwater Best Management Practices

BMP 23 Lawn Care



Activity: Facilities having lawns or vegetated areas.

Typical Pollutants: Fertilizers, pesticides, herbicides, fungicides, phosphorus, nitrogen, zinc, copper, and pH.

Typical Problem: Lawn care entails the application of fertilizers, herbicides, pesticides, and water in order to achieve a rich vibrant lawn. Weeds are quite often controlled through the application of chemicals. Over fertilizing and the over-application of pesticides and herbicides can contaminate storm water. Too much irrigation can wash these chemicals off the site into storm water conveyances, streams, rivers, and lakes. The nutrients, phosphorus, nitrogen, and pH can be detrimental to slow moving water bodies by encouraging algae growth. Herbicides and pesticides can adversely impact human health, fish and other wildlife. All of these pollutants can significantly affect the beneficial uses of water bodies.

BMP: If a landscape contractor is hired to take care of the lawn and other vegetated areas of the site, ensure that they do their part to protect the environment by applying the appropriate amount of chemicals. Encourage them to investigate more environmentally friendly alternatives to the use of chemicals such as a thin layer of compost on top of the lawn in the fall.

A few simple precautions can minimize adverse environmental impacts from lawn care. No matter what chemicals are used, over-watering can move the chemicals in to the storm water conveyance system. Use rain measuring equipment to automatically prevent automatic lawn sprinklers from turning on. In the Northwest, watering to a depth of six inches a couple of times a week is sufficient for a lush green growth. Always water in the morning, between 6 a.m. and noon, or in the evening around sundown so that the water has time to infiltrate before it evaporates

Fertilization:

For lawn fertilization, 1,000 square feet of lawn requires 0.5 pound of nitrogen per month of active growth (~8 months in Portland area ~ 4 pounds). A good ratio for fertilizer is 3 parts nitrogen

Industrial Stormwater Best Management Practices

to 1 part phosphorus to 2 parts potassium to 1 part sulfur (3:1:2:1). Use a slow release fertilizer such as one containing water insoluble nitrogen (WIN). After determining the amount of fertilizer to use per year based upon the growing season, apply the fertilizer in four equal applications of approximately one pound per 1,000 square feet each application, i.e. 1/4 in early spring, 1/4 in late spring, 1/4 in late summer, and 1/4 in the fall.

Have your site's soil tested to determine if other materials such as iron (for low pH soil < 6.8), boron, chlorine, copper, manganese, molybdenum, nickel, and zinc should be added for a healthy lawn. If soil testing indicates that one or more of the additives above is needed, contact your county Extension Agent, a lawn and garden center, or a master gardener for advice on how much of the additives to apply for optimum growing conditions.

Fertilizer over-use, over watering, and watering at the wrong time of the day set up a good environment for many grass diseases and for invasion by weeds that are very competitive with the grasses in the lawn.

Pest Management:

Pest management can be conducted in an environmentally friendly manner through:

- **Knowledge**
 1. knowing the variety of grass in your lawn;
 2. knowing its growth characteristics; and

- **Identification**
 1. identifying the weeds present;
 2. identifying the grass disease present; and/or
 3. identifying the insect pests present
 - a). Note where the pest is located on the lawn
 - b). Draw a picture of the pest or collect a sample
 - i. Research in books for a match of the pest found to a photograph;
 - ii. Contact local County Extension office for assistance and advice; or
 - iii. Take sample to local home and garden center for identification.

Weed removal is best accomplished by hand-pulling.

Maintain a buffer strip next to waterways. Do not apply fertilizer or pesticides to this strip. It is used to absorb excess fertilizer from the care of the rest of the lawn. It will also retain excess nutrients and sediments.

Healthy Lawn

Step 1: Lawn conversion Convert lawn areas into groundcover, trees, shrubs, or meadow plantings. For a low input approach, replace the grass underneath mature trees with groundcover. For an even lower input approach, examine your lawn for potential conversion areas and plant groundcovers, trees, shrubs, or perennials in all areas where grass is hard to grow. For the lowest input approach, use turf only where

Industrial Stormwater Best Management Practices

it is the best plant to fulfill a particular function, such as providing children's sports area.

Step 2: Soil building

Provide a strong foundation for the lawn. For a low input lawn, get a soil test to determine the soil's pH and fertility. You may not need to add any lime or fertilizer to your lawn. For a lower input lawn, test for soil compaction. Can you sink a screwdriver into the ground without pounding or is the soil compacted? If the soil is compacted, aerate with a hand corer or mechanical aerator. For the lowest input lawn, examine the soil's texture- neither extremely sandy soils nor extremely heavy clay soils make for good lawns. Next count earthworms - if none can be found in a square foot of soil, there's a problem. A healthy soil community has over 10 per square foot. With this basic understanding of soil acidity, fertility, compaction, texture, and earth-worms, one can build soil that supports dense, healthy turf.

Step 3: Grass selection

Choose the type of grass that will be easiest to grow. For a low input lawn, select hardy grass species adapted to your region's climate. For a lower input lawn, select named grass varieties to meet your specific needs. For the lowest input lawn, try the new low input slow growing or dwarf grass mixes.

Step 4: Mowing and thatch management

Mow to the right height at the right time and recycle clippings. For a low input lawn, leave clippings on the lawn to provide nutrients and moisture. For a lower input lawn, set mowing height as high as possible. For the lowest input lawn, adjust mowing height and frequency during the growing season and monitor thatch levels.

Step 5: Minimal fertilization

Give the lawn what it needs but don't overfeed. For a low input lawn, recycle clippings and (in the right season) apply commercial fertilizer at half the recommended rate; avoid weed and feed formulations and don't fertilize if rain is imminent. For a lower input lawn, fertilize as above but use encapsulated nitrogen or an organic product instead and fertilize only if soil tests show it's needed. For the lowest input lawn, substitute home generated compost for commercial organic or encapsulated products.

Step 6: Weed control and tolerance

Establish a realistic tolerance level for weeds and use less toxic control methods to maintain it. For a low input lawn use least toxic weed control methods such as: cultivation, solarization, flaming, mowing, or herbicidal soap. For a lower input lawn, grow strong healthy grass and it will crowd out weeds. For the lowest input lawn, broaden your definition of "lawn" to include weeds that perform desirable functions.

Step 7: Integrated pest

Establish a realistic tolerance level for pests and use least toxic con-

Industrial Stormwater Best Management Practices

management

control methods to maintain it. For a low input lawn, use least toxic control methods such as removing or trapping pests, introducing biological control agents, or apply least toxic chemical controls such as insecticidal soaps. For a lower input lawn, grow strong, healthy grass that can resist attack. For the lowest input lawn, use cultural controls to prevent infestation, protect natural predators, and add beneficial soil microbes.

Step 8: Sensible irrigation

Practice water conserving landscaping techniques.

For a low input lawn, water infrequently, in the early morning, but soak the lawn well. For a lower input lawn, water only when the lawn definitely needs it, and calibrate sprinklers. For the lowest input lawn, accept that the grass may not be green year round.

Efficiency/Impact: Proper maintenance of lawns and vegetative strips can be pleasing to the eye and provide environmental benefits such as reduced pollution to streams, rivers, and lakes, cooler runoff, reduce sediments in the runoff, and in some cases reduce other pollutants from the site. The degree that this BMP will be effective is directly proportional to the degree of involvement in the care of the lawn or the degree of caution exercised in selecting a lawn care contractor and the degree that the watering system is in tune with the lawn and the weather.

BMP 24 Dumpster Covering



Activity: Storage of general rubbish or food rubbish outside in dumpsters.

Typical Pollutants: Suspended solids, nutrients, bacteria, dioxin, chemicals

Typical Problem: Waste materials are typically removed from inside the site buildings to a collection container (dumpster) outside of the buildings. If these dumpsters have an open top or the top is left open at times when materials are not being dumped into them, storm water makes contact and will mix with the wastes and leak out to the storm water discharge conveyances for the site.

Industrial Stormwater Best Management Practices



BMP: There are two effective methods for addressing this concern. At the end of a building, extend the roof over the area where the dumpsters will be placed to keep storm water out. Slope the floor that the dumpsters are sitting on to a drain where the contaminated storm water/dumpster drainage can be collected and discharged to a sanitary sewer, if necessary.

The other method is to ensure that covers are on all of the dumpsters and that the covers are lowered when wastes are not being discharged into them. The second method has the most risk in that this method relies on employees always performing the proper procedure and many different situations can arise that may interrupt the procedure and prevent it from occurring. No matter which method is used, ensure that no storm water catch basin is located close by.

Efficiency/Impact: Either method for protecting wastes from storm water exposure will minimize or eliminate storm water pollution from this source. The method that relies on the least effort from employees is usually the most reliable.

Industrial Stormwater Best Management Practices

BMP 25 Semi-Trucks and Trailers



Activity: Trucking firms or other operations in which semi trailers are parked on site and dollies are used to attach to the trailers to move the trailers around the site or operations in which semi tractors are used on site.

Typical Pollutants: Oil and grease

Typical Problem: Fifth wheel hitching mechanisms used to attach semi-tractors or Yard Goats to semi-trailers have a thick coating of grease on them to minimize the friction encountered and to ease the attachment process during connection of tractors or Yard Goats to the trailers. When the Yard Goats or semi-tractors are parked and not attached to trailers the grease on the fifth wheel is exposed to storm water. This allows the storm water run-off to pick up the oil and grease.



BMP: Manufacture or purchase a quick install cover to slip over the hitch. A simple lightweight inexpensive cylindrical slip-on cover could be made out of fiberglass. Ensure that all operators of the equipment are instructed to place the cover over the hitches when they are not being used. Changing from the lubricated type fifth wheel hitch to a Teflon non-lubricated type is a better approach but, if rental or transit trailers are in use frequently this may not be a viable option due to the requirement that both the trailer and the tractor fifth wheel slider plates need to be coated with the Teflon.

Efficiency/Impact: While there will always be some exposure especially at the times the covers are removed for making connections and moving of the trailers, this method should minimize the adverse impact that the practice has on the storm water run-off.

Industrial Stormwater Best Management Practices

BMP 26 Fueling and Liquid Loading/Unloading Operations

Activity: Fueling operations performed by employees on-site or through restricted access systems such as Cardlock sites in various locals across the State.

Typical Pollutants: Gasoline and diesel fuels (Petroleum Hydrocarbon)



Typical Problem: Fueling nozzles can stick in the open or on position when fueling vehicles. Loading/unloading hoses can leak or become disconnected. Employees some times are not instructed in the correct methods for spill clean-up. Frequently, spill clean-up materials are not available at the dispensing pumps Or the loading areas. Fueling stations may not have roofed areas or properly sloped or contained areas for collecting spilled fuel. All of these situations and conditions can result in fuel or other liquids contacting storm water and entering the site runoff.



Cover



Berm

BMP: The fueling area should be designed and operated to minimize contact between spilled fuel, leaked fluids, and storm water. This can be accomplished through roofing the dispensing/loading/unloading area and providing an impervious berm to keep the surface runoff outside the liquid dispensing/loading/unloading areas.

- Use a damp cloth on the pumps and a damp mop on the pavement for area clean up.
- Clean up spills immediately:
 - Spread absorbent material and sweep it up with a broom.
 - Perform a hazardous waste determination on the absorbed material.

Industrial Stormwater Best Management Practices

- Dispose of the absorbed material properly.
- Ensure that the overflow nozzle protection is in working order.
- Do not try to top off tanks. Stop filling when the dispensing nozzle shuts off the first time.
- Remove any nozzle locking mechanism which allows the fuel to stay on with the operator absent. The operator should be present at all times to ensure that overfilling and spillage does not occur.
- Cover fueling areas and berm/slope the pavement under the roof to a drain system that is connected to a holding tank or contains the spillage at the surface for easy clean up.
- Provide an easily accessible and well-marked emergency shutoff for pumps with plainly written instructions on how to operate the shutoff.
- Never hose down the fueling area.
- Don't drain spills to the sanitary or the storm water sewers.
- Ensure that the fueling area has an undamaged continuous paved or otherwise impervious surface.
- Ensure that spill cleanup materials are readily available.
- For areas where multiple customers or operators from multiple companies have access, provide highly visible, simple instructions on how to clean up spills and report the incidence.
- Provide well placed, understandable instructions on the proper procedures to follow in the event of an emergency, including reporting information.

Efficiency/Impact: Implementation of this BMP can virtually eliminate this potential source of storm water contamination provided site inspection is frequently performed.

BMP 27 Parking Lots and Yards



Activity: Using gravel areas that do not have a geotextile underlay for vehicle storage, parking or other industrial usage.

Typical Pollutants: Total Suspended Solids, (TSS) turbidity, metals, oil, and other pollutants which attach to soil particles.

Industrial Stormwater Best Management Practices

Typical Problem: Vehicle wheels push the gravel into the underlying soil and pumps the fine soils up through the gravel.



BMP: Remove some of the gravel, place geotextile fabric, and reapply clean gravel on top. This will allow water to migrate through but provide a barrier to gravel soil movement.



Efficiency/Impact: Use of geotextiles to separate soil and rock in roadbeds and in parking lots greatly reduces the amount of soil available to migrate off site in the stormwater runoff. There is a much less expensive method than either asphalt or concrete paving to reduce the sediment and turbidity in the stormwater runoff. The use of these fabrics will normally reduce the level of soil in the runoff to below permitted levels

BMP 28 Stormwater Diversion - Speed Bumps and Speed Humps

Activity: Diverting runoff from sensitive areas or diverting it to an area where it can be treated or controlled

Typical Pollutants: Fertilizers, fuel, alcohol, granular products, just about any type of chemical, TSS, and etc.

Typical Problem: Either stormwater runs into an area that you do not want it to go and becomes contaminated or a product migrates into the stormwater runoff.

Industrial Stormwater Best Management Practices

BMP: Install an asphalt or a concrete or a temporary removable berm to either retain the product or divert the stormwater. In areas where the berm (width and height are approximately the same) would cause problems due to its height and short width, extend the width and make it into a hump (width is typically six or more times the height). The hump would work well where tractor trailer or lift truck operations occur. Humps are presently used in some cities to cause vehicle to slow down without the ability to cause major damage to the vehicles when crossed at reasonable speeds.



Efficiency/Impact: Implementing this control will greatly reduce or illuminate the mixing of pollutants from the mixing and can greatly facilitate the treatment of the runoff by keeping the volume of the runoff that needs to be treated to a minimum.

BMP 29 Grassy Filter Strip and Planter

Activity: Sites with surface water runoff contamination that have implemented specific non-point source BMPs for pollution prevention but have been unable to reduce the pollutant discharges in their storm water runoff to levels below the benchmarks. Unused excess land may be necessary to implement these BMPs.

Typical Pollutants: Sediment (TSS), PAH, metals, BOD, phosphorus, and hydrocarbons (Oil & Grease)

Typical Problem: When the implementation of specific point source BMPs has not eliminated or reduced the contaminants in the storm water to the specific benchmarks, end of the pipe or final discharge BMPs may be necessary.



Industrial Stormwater Best Management Practices

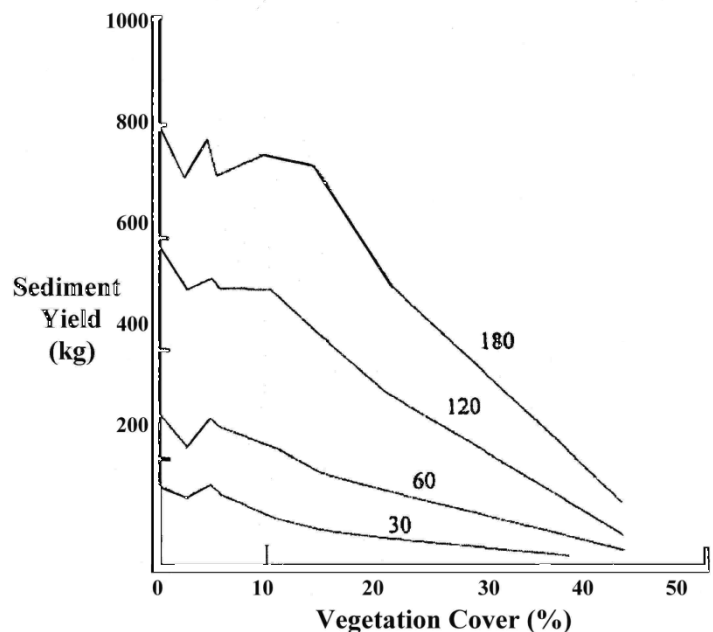
BMP: Install a grassy filter strip and ensure that the storm water passes through the strip in sheet flow. Vegetated filter (buffer) strips are best used on sites with sheet runoff, such as parking lots.

- Effective filter strip widths range from a minimum of 50 feet to a maximum of 200 feet.
- Best for smaller drainage basins, five acres or less.
- Not suitable on slopes or sites with shallow depth to bedrock .
- Best for sheet flow. Do not use on slopes over 10%.
- Good for conventional pollutants.
- Cannot be used to convey larger storms, or concentrated flow discharges as their effectiveness will be destroyed plus they could become sources of pollution through erosion.
- Best grasses are tall fescue, followed by western wheatgrass, annual or Italian Ryegrass, Kentucky Bluegrass.
- Rectangular and V shaped cross sections are the least desirable.
- Design to create a low velocity flow, bent grass is not as good a filter.
- Curbing for impervious areas draining to the filter strips should have a one-foot gap every five feet.



Efficiency/Impact: Properly sized and maintained vegetated filter strips can have a removal efficiency of up to 80 percent for suspended solids.

The graph on the right shows for different simulated rainfall events of a specific intensity and various durations of 30 to 180 minutes, the effect vegetation cover has on the retention and removal of sediment from a site with a 10 % slope.



Industrial Stormwater Best Management Practices

BMP 30 Catch Basin Insert Bag

Activity: Sites with surface water runoff contamination that have implemented specific non-point source BMPs for pollution prevention but have been unable to reduce the pollutant discharges in their storm water runoff to levels below the benchmarks. Unused excess land may be necessary to implement these BMPs.



Typical Pollutants: Sediment (TSS), PAH, metals, BOD, phosphorus, and hydrocarbons (Oil & Grease)

Typical Problem: When the implementation of specific point source BMPs has not eliminated or reduced the contaminants in the storm water to the specific benchmarks, end of the pipe or final discharge BMPs may be necessary.

BMP: Install a catch basin filter system (**normal flow**) without overflow slots in the filter media: a catch basin coupled with a sump and sediment traps (i.e. trapped or Lynch style catch basins). May also be used with an inlet device, prefiltering insert and screens (see other facilities and retrofit). The inserts consist of several filtering trays suspended from the inlet grate. Common filters are charcoal, wood fibers or fiberglass.

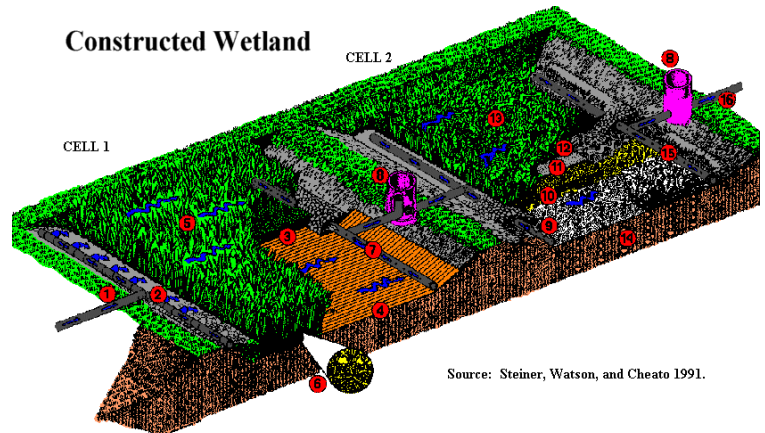
- Retains small particles, partially effective with high levels of particulate heavy metals, oil/grease, and TSS. Moderate reduction in TSS and turbidity. However, few pollutants are associated with these coarser solids.
- Disadvantage: When 60% full, the suspended solid deposition is in equilibrium with scour, and the capture efficiency is reduced to zero.
- Best in small basins and with treatment of highly turbid runoff prior to discharge to catch basin.
- Do not use on unstable or steep slopes.
- Usually used with vaults, tanks, sumps or inverted (hood) inlet. Inlet can be coupled with a filtration system (see retrofit).
- Maintenance is critical and must be at least semiannual. Require a maintenance schedule and plan for disposal of material removed by the catch basin.
- Insert maintenance is required quarterly and should be inspected more frequently during wet periods.
- Catch basins with a restrictor device (multiple orifice and weir/riser section) for controlling outflow provide minimal control for floatables and petroleum based products.
- Design the size of catch basin sump to handle the site runoff rate, TSS concentration in runoff and how often it will be cleaned out.
- To minimize groundwater pollution problems, be careful where infiltrating catch basins are used (residential areas) and pre-treat the infiltration water.
- **Using a Catch Basin Insert Filter Bag with a bypass or overflow is not recommended as they tend to bypass the inflow almost all of the time. Even during a relatively small rainfall event the types of catch basin insert bags with an overflow or bypass will tend to bypass on trapped (Lynch) type catch basins a significant amount of the runoff**

Industrial Stormwater Best Management Practices

thereby eliminating the benefits of using this BMP. Using an insert bag without an overflow or bypass may result in flow back up and cause temporary local flooding unless the bag has the largest surface area (filtering area) inside of the bag possible for the size of the catch basin in which it is used.

Efficiency/Impact: Catch Basin Filter System Efficiency: TSS up to 22%, and Turbidity up to 38%

BMP 31 Constructed Wetlands



See the **Biofilters** document at <http://www.deq.state.or.us/wq/stormwater/docs/nwr/biofilters.pdf> for further information on **Constructed Wetlands**.

Activity: Sites with surface water runoff contamination that have implemented specific non-point source BMPs for pollution prevention but have been unable to reduce the pollutant discharges in their storm water runoff to levels below the benchmarks. Unused excess land may be necessary to implement these BMPs.

Typical Pollutants: Sediment (TSS), PAH, metals, BOD, phosphorus, and hydrocarbons (Oil & Grease)

Typical Problem: When the implementation of specific point source BMPs has not eliminated or reduced the contaminants in the storm water to the specific benchmarks, end of the pipe or final discharge BMPs may be necessary.

BMP: Install a constructed wetland. Constructed wetlands are constructed by a combination of excavation and/or berming. The basic types of constructed wetlands are: shallow marsh, a 2 or 3 celled pond/marsh, extended-detention wetland and pocket wetland.

Storm water treatment facilities are not considered waters of the State; however, their discharge is regulated in the same way as any treatment system. Created wetlands built as mitigation for loss of wetlands under the Clean Water Act Section 404, are considered waters of the State. Created wetlands are protected as natural wetlands and cannot be used for conveyance or treatment of wastewater, unlike constructed wetlands.

- Extended-detention wetland and pocket wetlands are less effective in removal of some types

Industrial Stormwater Best Management Practices

of pollution than other types of wetlands.

- The constructed wetland should be lined when located over permeable soils for permanent pool maintenance. This is to prevent potential groundwater and soil contamination. Use a Bentonite clay (12" thick) or commercial heavy plastic pond liner (minimum 40 ml). Place a minimum of 18" thick compacted soil over the liner prior to seeding.
- The permanent pool depth should be between three to six feet in depth, plus one foot of dead storage for sediment. Six feet is the maximum depth or the pond will stratify in summer and create low oxygen conditions which result in the re-release of phosphorus and other pollutants. In addition, if the pond is deeper than six feet, it will likely pollute the groundwater.
- Suitable for larger sites up to 100 acres.
- Soils should be tested to determine suitability. Best when located in clay loams, silty clay loams, sandy clays, silty clays and clays.
- Cannot be used in areas with shallow depth to bedrock or unstable slopes.
- Good for removal of nutrients and conventional pollutants such as oil and grease and some heavy metals.
- Needs to have a shallow marsh system in association to deal with nutrients.
- Should be multi-celled, preferably three of equal sizes. The first cell should be three feet deep to trap coarse sediments and slow turbulence. They need to be designed as a flow through facility, and the pond bottom should be flat to facilitate sedimentation.
- Need to be designed with periodic maintenance in mind by using an overhead scooping device.
- Side slopes should be 2:1, not steeper than 3:1, and 10 to 20 feet in width. A length to width ratio of 5:1 is preferred, with a minimum ratio of 2:1 to enhance water quality benefits. The longer length allows more travel time and opportunity for infiltration, biofiltration and sedimentation.
- Pond berm embankments over six feet should be designed by a registered engineer. Berm tops should be 15 feet wide for maintenance access and should be fenced for public safety.
- Shape should be long, narrow, and irregular since these are less prone to short circuiting, are more effective, and maximize the treatment area.
- Baffles can be used to increase the flow path and water residence time.
- Should have an overflow system/emergency spillway to accommodate a 100 year, 24 hour flood and a gravity drain.
- Maintenance is of primary importance. The site must be responsibly selected. A maintenance plan needs to address removal of dead vegetation (that release nutrients) prior to the winter wet season, debris removal from trash racks, sediment monitoring in forbays and in basin are likely to contain significant amounts of heavy metals and organics (regular testing is advised).
- Access to the wet pond is to be restricted with a gate and posted signs.
- For mosquito control, either stock the pond with fish or allow it to be drained for short periods of time (do not kill the marsh vegetation).
- Constructed wetland is more complex, with more vegetation, and shallower with greater surface area, hydrologic factors (flow) play a larger part in siting.
- Selection of vegetation should be done by a wetland specialist.
- Oil/water separators can be used prior to the constructed wetland, depending upon the surrounding land uses.
- Relatively low maintenance costs.
- Fence off for safety (children), to protect plants/wildlife.

Industrial Stormwater Best Management Practices

- Disadvantages/constructed wetlands:
 - a.) Constructed wetlands have a larger land requirement for equivalent service compared to a wet pond.
 - b.) Relatively high construction costs.
 - c.) Delayed efficiency until plants are well established (1–2 seasons).
- Buffer width 25 to 50 feet.
- Limit water level fluctuations, as they kill plants.

Efficiency/Impact: Wet pond/wetland removal efficiencies:*

- a) Heavy metals = 40 to 80%;
- b) Total Phosphorus = 40 to 80%
- c) Total Nitrogen = 40 to 60%
- d) TSS = 70%
- e) Soluble reactive phosphorus 75%
- f) Nitrate = 65%
- g) Ammonia = -43
- h) COD = 2
- i) Total copper, lead and zinc = 80 to 95%

* Higher efficiencies are associated with use of O/G trap, larger pond/marsh area and volume. These efficiencies assume that the intensity of the storm water inflow does not exceed the capacity of the wetlands and that the pollutants are not in a concentrated form from a large spill or discharge.

BMP 32 Bioswales



See the Biofilters document at <http://www.deq.state.or.us/wq/stormwater/docs/nwr/biofilters.pdf> for further information on Bioswales.

Activity: Sites with surface water runoff contamination that have implemented specific non-point source BMPs for pollution prevention but have been unable to reduce the pollutant discharges in their storm water runoff to levels below the benchmarks. Unused excess land may be necessary to implement these BMPs.

Typical Pollutants: Sediment (TSS), PAH, metals, BOD, phosphorus, and hydrocarbons (Oil & Grease)

Industrial Stormwater Best Management Practices

Typical Problem: When the implementation of specific point source BMPs has not eliminated or reduced the contaminants in the storm water to the specific benchmarks, end of the pipe or final discharge BMPs may be necessary.

BMP: Install a grassy bioswale. Swales basically act as filters for runoff from frequent storms. The principle form of treatment is the settling out of pollutants and the use of vegetation to take up the dissolved fraction. For best results a swale should be designed to deal with the peak runoff for a two year, 24 hour storm event.

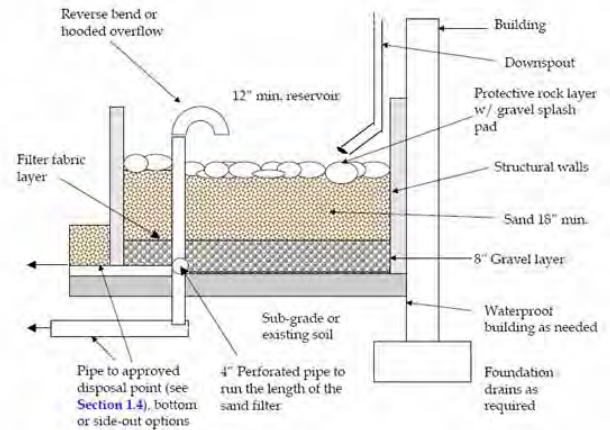
- Does well with first flush runoff, economically feasible, improves aesthetics and has minimal environmental impacts. Best in median strips and parking lot islands.
- The organic topsoil layer is good for degrading petroleum solvents, heavy metals, nutrients and hydrocarbons.
- Critical design elements: size of drainage area to be treated, location of bioretention areas, sizing guidelines, calculate water budget.
- Biofiltration is suitable for smaller sites 10 or less acres.
- Needs a minimum width of 20 feet.
- Must be graded to create sheet flow, not a concentrated stream. Sheet flow decreases the chance of producing gully erosion and distributes contaminants over a wider area. Level spreaders (i.e. slotted curbs) can be used to facilitate sheet flow.
- Can be placed anywhere with careful site design.
- Do not use on steep, unstable slopes or landslides.
- Can reduce peak flow rates.
- Best when used for treatment and conveyance of storm water after a settling pond.
- Good for nutrient removal and conventional pollutants such as suspended solids and some heavy metals.
- Best at 200 feet in length, in tight spaces obtain more length by using a curved path. Should have a maximum bottom width of 50 feet. One foot high check dams should be installed every 50 feet starting 20 feet downstream from the inflow point.
- Good when used at a storm water outfall, commercial development or roadside.

Efficiency/Impact: Bioswales can, when sized correctly and when incorporated with an upstream settling pond, provide similar pollutant removal efficiencies to those achieved by a biopond or constructed wetland.

Removal efficiencies:	a) TSS = 83 to 92%
	b) Lead = 67%
	c) Copper = 46%
	d) Total phosphorus = 29 to 80%
	e) Total zinc and aluminum = 63%
	g) Oil/grease/TPH = 75%
	h) Nitrate-N = 39 to 89%

Industrial Stormwater Best Management Practices

BMP 33 Sand Filters



Activity: Sites with surface water runoff contamination that have implemented specific non-point source BMPs for pollution prevention but have been unable to reduce the pollutant discharges in their storm water runoff to levels below the benchmarks.

Typical Pollutants: Total Phosphorus, Heavy Metals, Bacteria, Total Nitrogen

Typical Problem: When the implementation of specific point source BMPs has not eliminated or reduced the contaminants in the storm water to the specific benchmarks, end of the pipe or final discharge BMPs may be necessary.

BMP: Installation of a sand filter has shown to reduce some heavy metals.

Efficiency/Impact: Research has shown zinc to be reduced to as little as 8% of the original concentration. More research is needed to determine the effect a sand filter will have on other metals. The mechanism for the removal of the metals is not completely understood at this time. Due to the particle size, this method should have negligible effect on the dissolved metals.

Typical Pollutant Removal Efficiency

Pollutant	Percent Removal	Pollutant	Percent Removal
Biochemical Oxygen Demand (BOD)	70	Total Kjeldahl Nitrogen (TKN)	46
Total Suspended Solids (TSS)	70	Total Phosphorus (TP)	33 - 85
Total Organic Carbon (TOC)	48	Iron (Fe)	45
Total Nitrogen (TN)	21-47	Lead (Pb)	45
Zinc (Zn)	45	Bacteria	55

Industrial Stormwater Best Management Practices

BMP 34 Porous Pavers

Activity: Areas of a site in which uncontaminated runoff is occurring, the likelihood of chemical or fine particle spill is minimal, and the underlying soils have a capacity to infiltrate. This should also generally be an area of no or low weight vehicle traffic, i.e. sidewalks, passenger automobile parking or traffic areas.

Typical Pollutants: Oil & Grease, small quantities of biodegradable chemicals

Typical Problem: Fairly clean runoff is mixing with contaminated runoff such that the combined volume of runoff is expensive to treat or there is a desire to recharge the shallow subsurface aquifer rather than constructing additional drainage structures or systems.



BMP: Use pavers, porous concrete, and in some cases porous asphalt to provide drainage, surcharge of the shallow aquifer, and a reduction in the stormwater runoff.

Efficiency/Impact: Small amounts of petroleum contamination will be treated by the biota in the shallow soils beneath the porous material. If sediment is present refreshing the porosity can be challenging unless removable pavers are used. In the case of the use of porous asphalt it is unknown as to whether or not the asphalt can be renewed as it is doubtful that a sealcoat can be applied to extend the life of the material as can be done for standard parking lots or roads. If the porous material is properly designed and installed there is the ability to drain fairly large areas in western Oregon during the rainy season and thus reduce or eliminating storm water runoff. This BMP should not be used in areas that have a likelihood of spills or sediment loading.

BMP 35 Flocculation



Activity: Sites with surface water runoff contamination that have implemented specific non-point source BMPs for pollution prevention but have been unable to reduce the pollutant discharges in their storm water runoff to levels below the benchmarks. Unused excess land may be necessary to implement these BMPs.

Industrial Stormwater Best Management Practices

Typical Pollutants: Sediment (TSS), PAH, metals, BOD, phosphorus, and hydrocarbons (Oil & Grease)

Typical Problem: When implementation of specific point source BMPs have not managed or eliminated the contaminants in the storm water to the benchmarks or below or where potential point sources for the contaminants cannot be identified, end of the pipe or final discharge BMPs may be necessary.

BMP: Install a flocculation system using a flocculent such as Chitosan, Calgon Cat Flocc 2953, or a Polyaluminum Chloride such as Sumalchlor-50 or other.

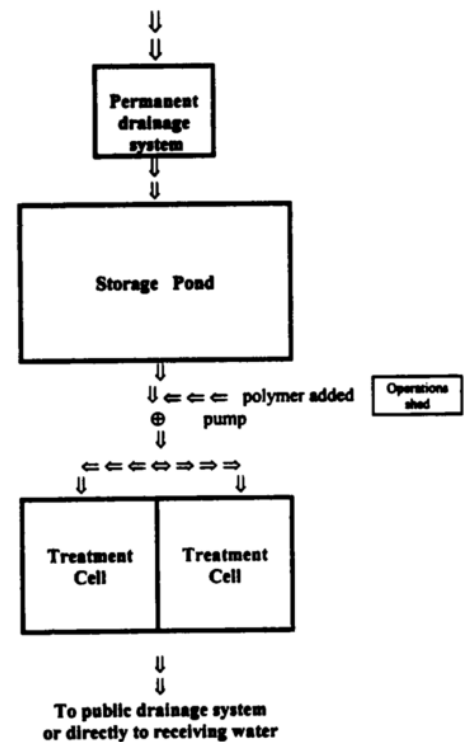
Fine particles suspended in water give it a milky appearance, usually measured as turbidity. Their small size, often much less than 0.001 mm in diameter, give them a very large surface area relative to their volume compared to Total Suspended Solids particles that are in the range of 0.0015 mm in size and larger. These fine particles typically carry a negative surface charge. Largely because of these two factors, small size and negative charge, these particles tend to stay in suspension for extended periods of time. Because of this, removal is not practical by settling alone. Polymers and inorganic chemicals speed the process of clarification. The added chemical destabilizes the suspension and causes the smaller particles to agglomerate. The process consists of three steps: coagulation, flocculation, and settling or clarification.

The conditions under which clarification is achieved can affect performance.

Currents can reduce settling efficiency. Currents can be produced by wind, by differences between the temperature of the incoming water and the water in the clarifier, and by flow conditions near the inlets and outlets. Calm water such as that which occurs during batch clarification provides a good environment for effective performance, as many of these factors become less important in comparison to flow-through clarification basins. One source of currents that is likely important in batch systems is movement of the water leaving the clarifier unit. Given that flocs are relatively small and light the exit velocity of the water must be as low as possible. Sediment on the bottom of the basin can be resuspended and removed by fairly modest velocities.

Coagulants and flocculant-aids:

Polymers are large organic molecules that are made up of subunits linked together in a chain-like structure. Polymers that carry groups with positive charges are called cationic. Cationic polymers can be used as primary coagulants to destabilize negatively-charged turbidity particles present in storm water. Inorganic chemicals such as aluminum or ferric sulfate and aluminum or ferric chloride can also be used, as these chemi-



Industrial Stormwater Best Management Practices

cals become positively charged when dispersed in water.

In practice, the only way to determine whether a polymer is effective for a specific application is to perform preliminary or on-site testing. Polymer effectiveness can degrade with time and also from other influences. Thus, manufacturers' recommendations for storage should be followed.

Application of coagulants and flocculant-aids at the appropriate concentration or dosage rate for optimum turbidity removal is important for management of chemical cost, as well as for effective performance. The optimum dose in a given application depends on several site-specific features. The turbidity of untreated water is a primary determinant. The surface charge of particles to be removed is also important, as previously noted. Environmental factors that can influence dosage rate are water temperature, pH, and the presence of constituents that consume or otherwise affect polymer effectiveness (for example, color, oils). Preparation of working solutions and thorough dispersal of polymers in water to be treated is also important to establish the appropriate dosage rate.

Design engineers wishing to review more detailed presentations on this subject are referred to the following textbooks:

- Fair, G., J. Geyer and D. Okun, *Water and Wastewater Engineering*, Wiley and Sons, NY, 1968.
- American Water Works Association, *Water Quality and Treatment*, McGraw-Hill, NY, 1990.
- Weber, W.J., *Physicochemical Processes for Water Quality Control*, Wiley and Sons, NY, 1972.

Comparisons

The above discussion indicates that the design and operation of a polymer system should take into consideration the factors that determine optimum, cost-effective performance. It may not be possible to fully incorporate all of the classic concepts into the design because of practical limitations at construction sites. Nonetheless it is important to recognize the following:

- The right polymer must be used at the right dosage. A dosage that is either too low or too high will not produce the lowest turbidity. There is an optimum dosage rate. This is a situation where the adage "more is always better" does not apply.
- The coagulant must be mixed rapidly into the water to ensure proper dispersion.
- A flocculation step is important to increase the rate of settling, to produce the lowest turbidity and to keep the dosage rate as low as possible.
- Too little energy input into the water during the flocculation stage results in flocs that are too small and/or insufficiently dense. Too much energy can rapidly destroy floc as it is formed.
- Since the volume of the basin is a determinant in the amount of energy per unit volume, a basin can be too big relative to the size of the energy input system.
- Care must be taken in the design of the withdrawal system to minimize outflow velocities.

Number and volume of treatment cells

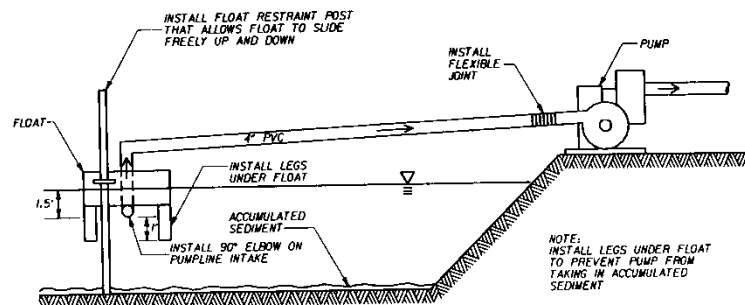
There are three reasons for having two rather than one treatment cell. First, if something goes wrong with the treatment of a particular batch, the contractor can continue treatment in the second cell. Oregon Department of Environmental Quality

Industrial Stormwater Best Management Practices

cond cell while dealing with the problem in the first cell. The second reason is the uncertainty over the time required to achieve satisfactory clarification. If one had confidence that satisfactory settling could be achieved consistently within 30 to 60 minutes, it might be reasonable to conclude that only one cell is needed since turnover could occur rapidly. The third reason is the time to empty the cell after treatment. It therefore seems appropriate to use two cells.

The second consideration is the volume of the individual treatment cell. There are two opposing considerations in sizing the treatment cells. There is a desire to have a large cell- so as to be able to treat a large volume of water each time a batch is processed. However, the larger the cell the longer the time required to empty the cell. It is also possible that the larger the cell the less effective the flocculation process, and therefore the settling. The simplest approach to sizing the treatment cell is to multiply the allowable discharge rate by the desired draw-down time. The desired draw-down time is about four hours.

A four-hour draw-down time allows one batch per cell per eight hour work period. A batch can be prepared in the morning including an hour or so of flocculation followed by about two hours of settling followed by discharge, although discharge could occur after hours. Or a batch can be prepared in the afternoon, followed by settling overnight, with discharge the following morning. The main point is that it appears to be most logical to size the cell to fit the desired drawdown time, constrained by the allowable release rate.



FLOATING PUMPLINE INTAKE (TYP.)

Configuration of the outlet device

The withdrawal device used for removing the liquid from the settling pond should be designed so that pulling settled sediments from the bottom of the treatment cell in the vicinity of the device does not occur. Whether this is a problem is not known but it should be evaluated. One approach is to place the discharge outlet near the area where treated water enters the cell. At this location there will be relatively little accumulation of solid because of the turbulence created by the incoming water.

A second approach is to use the float configuration as in the diagram shown above. The use of four rather than one inlet pipe reduces the inlet velocity. Reduced inlet velocity reduces the possibility that sediments will be picked up and discharged from the settling pond.

A third approach is to modify the float to include a square circular weir that the water enters before reaching the outlet pipe. A circular weir with, say, 10 feet of circumference would significantly reduce the overflow rates (velocity) over the weir. As an example, examine how exit ve-

Industrial Stormwater Best Management Practices

locities are kept as low as possible in water and wastewater clarifiers. These clarifiers include what is known as effluent launders. They are long troughs, placed at the outlet end the clarifier or around the outside circumference in the case of circular clarifiers, into which the water flows. Actually weirs, they reduce the exit velocity of the water leaving the clarification area of the clarifier.

The weir may provide at least one and possibly two benefits with the treatment of storm water. First, it may reduce the carry-out of floc that is still settling while the cell is being drawn down, could result in lower final effluent turbidities and/or allow a reduction in the settling time to achieve the same effluent turbidity. Secondly, the weir could reduce if not eliminate the tendency for the withdrawal pipe to suck-up previously settled sediment.

FLOCCULATION SYSTEMS SHOULD BE DESIGNED BY KNOWLEDGEABLE PERSONNEL. A CONSULTANT SHOULD BE CONTRACTED WITH TO DEVELOP AND IMPLEMENT A SYSTEM. OPERATING PERSONNEL NEED TO BE SPECIFICALLY TRAINED TO OPERATE THESE SYSTEMS.

Chitosan

A product made from shrimp and crab shells called Chitosan has started to be used in Oregon. This material comes in two forms, the semi liquid and a semisolid. Chitosan in the solid form is available in a sock that can be mounted inside of a pipe. This sock form would be released based upon the flow of water around it and does not require the injection and monitoring equipment that other flocculation systems require.



The picture on the left shows a Chitosan sock.

In the picture on the right a sample of turbid water is shown after the Chitosan solid has been lightly dipped and stirred in the sample and left for approximately 10 minutes. The flocculated sediment can be seen forming in the bottom of the jar.

Efficiency/Impact: Mean turbidity reductions can be achieved in the 95.5% to 99.4% range. Metals and other pollutants may be treated with removal efficiencies of 35 to 99 %.

BMP 36 Electrocoagulation

Activity: Sites with surface water runoff contamination that have implemented specific non-point source BMPs for pollution prevention but have been unable to reduce the pollutant dis-

Oregon Department of Environmental Quality

Industrial Stormwater Best Management Practices

charges in their storm water runoff to levels below the benchmarks.

Typical Pollutants: Sediment (TSS), PAH, metals, BOD, phosphorus, and turbidity

Typical Problem: When implementation of specific point source BMPs have not managed or eliminated the contaminants in the storm water to the benchmarks or below or where potential point sources for the contaminants cannot be identified, end of the pipe or final discharge treatment BMPs may be necessary.

BMP: Experiments with a process tentatively called ElectroFloc or Electrocoagulation indicates that it may be possible to use electricity to floc dissolved metals, TSS, turbidity, and other pollutants from storm water runoff. By charging aluminum plates with about 40 volts DC in a batch process, it has been shown to create an approximately equal number of charged particles in suspension. These dissimilar charged particles attract each other and due to aluminum ions present remain in contact with each other in as little as five minutes per liter. This works for TSS and turbidity in the lab and should work for dissolved metals as the metals usually are not really dissolved but submicron in size particles. Dissolved oxygen is increased in the water due to the splitting of the water molecule into hydrogen and oxygen in which the hydrogen leaves the water and the oxygen saturates the water volume. Some commercial package units are available.

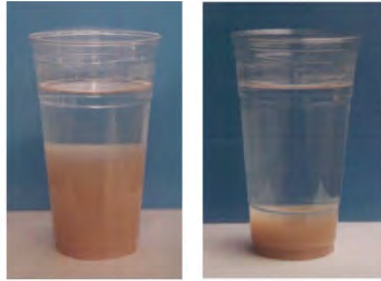


Lab Test Unit showing some floc forming on the surface



Industrial Package Unit

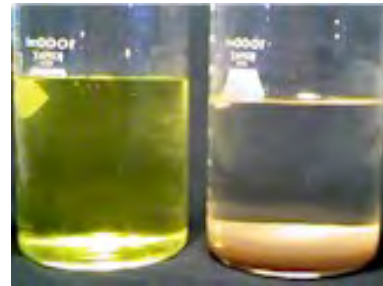
Industrial Stormwater Best Management Practices



Electro-pulse treatment after 2 minutes of settling time.

Electro-pulse treatment after 3 minute of settling time.

Turbidity from Clay Soils



Chromium

Efficiency/Impact:

Lab tests have repeatedly show that TSS and turbidity can be reduced by 98% and the dissolved oxygen content can be increased to around 16 mg/l. The following are various manufacturers' test removal results for the units that they provide:

Arsenic	37 %	Aluminum	75-99.7 %
Barium	94 %	BOD	53-89 %
Calcium	69-98 %	Cadmium	98-99.9 %
COD	65.4-86.2 %	Chromium, Hexavalent	99.9 %
Chromium, Total	97-99.9%	Copper	97-99.9 %
Cyanide	96.1 %	Fluoride	56 %
Iron	95-99 %	Lead	76-98 %
Magnesium	31-74 %	Nickel	90-99.7%
Nitrogen, Total	41.5 %	Oil & Grease	99.5 %
Phosphate	75-97 %	Phosphorus, Total	90.2 %
Radium (pCiL)	98 %	Selenium	44 %
Silicon	84-99 %	Strontium	49 %
Sulfate	33 %	TOC	96-98.6 %
TSS	45.5-99 %	Turbidity	77.8 %
Uranium	96 %	Vanadium	70 %
Zinc	96-99.9%		

References

(Individual manufacturers or suppliers are shown as examples of equipment discussed in this document only and are not specifically recommended by DEQ.)

1. Alfred Kärcher Inc. (1999). *The Kärcher ASA 600 Waste-Water Recycling System*. [On-line]. Available: <http://www.karcher.com>.
2. Botts, J., L. Allard & J. Wheeler. (1998). *Structural Best Management Practices for Storm Water Pollution Control at Industrial Facilities*.
3. Bowler, P. & J. Malek. (1997). *Wetland Restoration/Global Sustainability*. University of California - Irvine.
4. DeLancy, T.A. (1995). *Benefits to Downstream Flood Attenuation and Water Quality as a Result of Constructed Wetlands in Agricultural Landscapes*. American Farmland Trust; Journal of Soil and Water Conservation: <http://www.jswnonline.org/content/50/6/620.short>
5. Environmental Best Manufacturing Practices. (1999). *How to be green and stay in the black*. [On-line]. Available: <http://www.bmpcoe.org/library/books/navso%20p-3680/index.html>
6. FloTrend Systems, Inc. (1999). *About Flo Trend Systems, Inc. - Container Filters*. [On-line]. Available: <http://www.flotrend.com/>.
7. Foss Environmental (1998). [On-line]. Available: <http://www.fossenv.com>.
8. Gullywasher (1998). *Catch Basin Inserts* [On-line]. Available: <http://www.gullywasher.com>.
9. Jelen, S.L. & R.C. Sutherland. (1996). *Studies Show Sweeping Has Beneficial Impact on Storm water Quality*. American Public Works Association Reporter; <http://www.apwa.net/Resources/Reporter/>
10. Jelen, S.L., G. Minton & R.C. Sutherland. (1998). *High Efficiency Sweeping as an Alternative to the Use of Wet Vaults for Storm water Treatment, Advances in Modeling the Management of Storm water Impacts*. Vol. 5 & Vol. 6, ISBN 0-9697422-8-2. [On-line]. Available: <http://pacificwr.com/Publications/Chapter18-wetvaults.pdf>
11. Jurries, D. (1997). *Best Available Economical Environmental Practices*. Blackhawk Services.
12. KriStar. (1998). *Fossil Filter*. [On-line]. Available: <http://kristar.com>.
13. Landa Inc. (1999) *North America's largest manufacturer of pressure washers and water cleaning systems*. [On-line]. Available: <http://www.landa-inc.com>
14. Los Alamos National Laboratory Pollution Prevention Program Office. (1998). [On-line]. Available: <http://www.lanl.gov>.

Industrial Stormwater Best Management Practices

15. National Technology Transfer Center. (1999). [On-line]. Available: <http://iridium.nttc.edu>.
16. North Carolina Department of Environment and Natural Resources. (1999). *Division of Water Quality*. [On-line]. Available: <http://portal.ncdenr.org/web/wq/ws/su>
17. Ohio Environmental Protection Agency. (1993). *Extending the Life of Metal Working Fluids*, Ohio EPA Fact Sheet – Number 11. [On-line]. Available: <http://www.P2pays.org/ref/01/00072.htm>.
18. Oregon Association of Clean Water Agencies. (1998). *Municipal Storm water Toolbox for Maintenance Practices*.; <http://www.oracwa.org/pdf/or-municipal-stormwater-toolbox-for-maintenance%20practices.pdf>
19. Oregon Department of Environmental Quality. (1998). *Storm Water Management Guidelines*.
20. Pacific Northwest Pollution Prevention Research Center. (1998). [On-line]. Available: <http://www.pprc.org>
21. Parts Washers and Water Recycling Systems. (1998). [On-line]. Available: <http://www.hotsy.com>
22. Pollution Engineering. (1998). [On-line]. Available: <http://www.pollutioneng.com>.
23. Pollution Online. (1998). [On-line]. Available: <http://www.pollutiononline.com>.
24. Pollution Prevention Management Company. (1996). *Selected Pollution Prevention Techniques for Wastewater Agencies*.; 6327 SW Capitol Highway, Suite 101, Portland, (503)225-1050
25. Ruisinger, T.P. (1996). Ozonation in Cooling Water Systems. *Plant Engineering Magazine*. The Marley Cooling Tower Co.; <http://www.highbeam.com/doc/1G1-18669207.html>;
<http://www.plantengineering.com/magazine.html>
26. Resource Planning Associates/HoweConsult. (1999). *Polymer-Assisted Clarification of Storm water from Construction Sites: Experience in the City of Redmond, Washington*. [On Line] Available: <http://www.regulations.gov/#!documentDetail;D=EPA-HQ-OW-2008-0465-1497>
27. The Scotts Company. (1999). *Lawn care and gardening tips and products for the homeowner and do-it-yourself markets*. <http://www.scotts.com/>
28. The Schwarze EV-series Cleaners. (1999). [On-line]. Available: <http://www.schwarze.com/sweepers/ev>.
29. StormTreat Systems (1999). [On-line]. Available: <http://www.stormtreat.com>
30. Canister Filtration; Contech Engineered Solutions LLC. Available: <http://www.conteches.com/>
31. University of Idaho. (1999). *Best Management Practices for Small, Medium, and Large Lawns in the Pacific Northwest Water Quality Brochure*. [On-line]. Available: <http://www.uidaho.edu/wq/wqbr/wqbr23.html>.

Industrial Stormwater Best Management Practices

32. U.S. Environmental Protection Agency. (1998). *Sector Notebook Reports*. [On-line]. Available: <http://www.epa.gov/>
33. U.S. Environmental Protection Agency - Office of Water (EN-336). (1993). *Guidance Manual for Developing Best Management Practices (BMP)*. EPA 833-B-93-004. USEPA; <http://www.epa.gov/>
34. Stormwater Treatment Northwest. Vol. 6, No.2, July 2000; <http://www.stormwaterbook.com/newsletter.html>
35. Ben R. Urbonas, P. E., Chief, Master Planning Program, “*Sand Filter Design, Hydraulic Design of Sand Filters for Stormwater Quality*”, (1997), [On-line]. Available: http://www.udfcd.org/downloads/pdf/tech_papers/Sand-flt-paper.pdf
36. EPA, “*Storm Water Technology Fact Sheet – Sand Filters*”, EPA 832-F-99-007, September 1999, [On-line]. Available: http://water.epa.gov/scitech/wastetech/upload/2002_06_28_mtb_sandfltr.pdf
37. EPA, “*Storm Water Technology Fact Sheet – Water Quality Inlets*”, EPA 832-F-99-029, September 1999, [On-line]. Available: http://water.epa.gov/scitech/wastetech/upload/2007_05_29_mtb_wtrqlty.pdf
38. ChemFree Corporation, “SmartWasher”, [On-line]. Available: <http://www.chemfree.com>
39. Haz-Stor, “Hazardous Storage Buildings”, [On-line]. Available: <http://www.hazstor.com>
40. Hazmat Storage Containers, “Containment Pallets”, [On-line]. Available: <http://www.hazmatstorage.com>
41. Tennant Company, “Sweepers & Scrubbers”, [On-line]. Available: <http://www.tennantco.com>
42. Seeds and Lawns; Hobbs & Hopkins, 1712 SE Ankeny St., Portland, OR 97215, (503) 239-7518, [On-line]. Available: <http://www.protimelawnseed.com/>
43. EPA, “*Storm Water Technology Fact Sheet – Modular Treatment System*”, EPA 832-F-99-044, September 1999, [On-line]. Available: http://water.epa.gov/scitech/wastetech/upload/2002_06_28_mtb_modtreat.pdf
44. CJE Consultants and Contractors, Inc., P.O. Box 65, Turner, OR 97392, (503) 743-2291, “*Flocculation System Summary – West Linn Corporate Park*”, September 30, 1999, e-mail: cje@viser.net.
45. Advanced Environmental Solutions, Inc., “*Containment Pallets & Berms*”, [On-line]. Available: <http://www.advenvironmental.com>.
46. Watershed Protection Techniques, 1(5): 254-264; “*Toward a Low Input Lawn*”; Available: Stormwater Manager's Resource Center; <http://www.stormwatercenter.net>
47. Ecosystems and Water Quality Conference, March 18-21, 1996, U.S. EPA and the Northeastern Planning Commission, Chicago, IL., “*New Critical Source Area Controls in the SLAMM Storm-*

Industrial Stormwater Best Management Practices

water Quality Model”, Robert Pitt, Dept. of Civil Engineering, University of Alabama at Birmingham.

48. Chitosan, HaloSource, Inc.; 1725 220th Street SE Suite 103, Bothell, WA 98021; (425) 861-9499, 425-881-6464; <http://www.halosource.com/index.aspx>
50. Raising the Bar on Construction Storm Water Treatment, Stormwater Magazine, May/June 2004, <http://www.forester.net>
51. UltraTech International Inc., Portable Containment Berm, 800-353-1611, <http://www.spillcontainment.com>
52. Technical and Regulatory Guidance Document for Constructed Wetlands, December 2003, Interstate Technology Regulatory Council (ITRC), <http://www.itrcweb.org/>
53. Sentry Portable Welding Fume Extractor high efficiency HEPA filtration. Sentry Air Systems, Inc. (800) 799-4609, <http://www.sentryair.com>
54. Welding Fume Control; Hawthorne Systems, Inc. (419) 643-5861, <http://www.hawthornesystems.com/index.html>
55. Abanaki Oil Skimmers, Abanaki Corporation Oil Skimmer Division (800) 358-7546, <http://www.abanaki.com/petrox.html>
56. Hydro Engineering, Inc., Portable Wash Rack “*Closed Loop Wash Rack System*”, 800-247-8424, <http://www.hydroblaster.com>
57. Pavement deep cleaning scrubbing system; EnviroClean Seattle Inc. (206) 835-7000
58. Parking Lot Supply, Speed Bumps and Speed Humps, (888)776-2498, www.parkinglotsupply.com
59. EPA - Stormwater Best Management Practices (BMP) Performance Analysis, Tetra Tech, Inc, 2010, <http://www.epa.gov/region1/npdes/stormwater/assets/pdfs/BMP-Performance-Analysis-Report.pdf>
60. The Lawn Institute. [On-line]. Available: <http://www.lawninstitute.com>.
61. University of Idaho. (2003). *Best Management Practices for Small, Medium, and Large Lawns in the Pacific Northwest Water Quality Brochure*. [On-line]. Available: <http://www.uiweb.uidaho.edu/wq/wqbr/wqbr23.html>
62. Upper Susquehanna Coalition (USC) Wetland Program <http://www.u-s-c.org/html/wetlandprogram1.htm>
63. Washington Stormwater Center (1998). [On-line]. Available: <http://www.wastormwatercenter.org/>

Attachment G

Reclamation Plan

**RECLAMATION PLAN
FOR
WATTERS QUARRY
Columbia County, Oregon**

**Written for
MORSE BROS., INC.
32260 Old Highway 34
Tangent, Oregon
.May 11, 1995**

Prepared by



Environmental Science Associates, Inc. 1450 Flintridge Avenue Eugene, Oregon 97401 (503) 683-4997 FAX 683-4997

TABLE OF CONTENTS

1.0 PURPOSE	1
2.0 SITE LOCATION	1
3.0 SITE CONDITIONS	1
4.0 GEOLOGIC CONDITIONS	2
5.0 MINING OPERATIONS	2
6.0 RECLAMATION	3
7.0 REFERENCES	5
8.0 RESOURCES	5

APPENDICES

APPENDIX A:	Location Map, Topography Map, Air Photos
APPENDIX B:	Columbia County Reclamation Plan
APPENDIX C:	Reclamation Literature
APPENDIX D:	Oregon DEQ Recommended Best Management Practices for Storm Water Discharges.
APPENDIX E:	Professional Credentials

PLATES

PLATE 1:	Site Plan and Cross Section	in pocket
----------	-----------------------------	-----------

RECLAMATION PLAN FOR WATTERS QUARRY

Columbia County, Oregon

1.0 PURPOSE

The purpose of this reclamation plan is to provide a design for the Watters Quarry that meets or exceeds mining and reclamation requirements established by Columbia County. Goals set forth in this document are based on the 1990 Columbia County Surface Mining Ordinance. The completed Columbia County Reclamation Plan form is located in Appendix B. In addition, the following reclamation plan is intended to comply with existing rules and regulations from the following agencies: Oregon Department of Environmental Quality, Oregon Water Resources Department, and Oregon Occupational Health and Safety Department.

2.0 SITE LOCATION

Watters Quarry is located northwest of the city limits of St. Helens. Highway 30 lies about 600 east of the property and Pittsburg Road is about 1000 feet south. The property includes all or portions of three tax lots described as Tax Lot 300, Section 33, Township 5 North, Range 1 West, Tax Lot 400, Section 32, Township 5 North, Range 1 West and Tax Lot 1600, Section 33, Township 5 North, Range 1 West of Columbia County, Oregon. Total acreage in the three tax lots is 269.36 acres. The southern portions of tax lot 400 and 1600 are cut by a designated "Urban Growth Boundary" which excludes approximately 55 acres from a conditional use for mining purposes.

3.0 SITE CONDITIONS

The site consists of a partially tree covered, sloping tract of land lying on the west bank of the Columbia River. Topographically, the highest elevation, located along the west side of the property, is 400 feet (above Mean Sea Level) and the lowest is on the east side bordering Highway 30 at an elevation of 120 feet. The slope is about 14:1 with minor topographic irregularities caused by incised erosion drainages that flow eastward toward the river. A natural visual screen lies along the eastern side. The screen is a slope break formed by a steep, 50 foot high slope that rises from the flat river terrace where Highway 30 is located.

Mining began on the north side of the site prior to 1953 as evidenced by the aerial photograph (Appendix A). By the end of 1994 mining activity had affected approximately 35 acres, all located in the northeast corner of the tax lot 300. Currently, only the northeast corner has been disturbed with the remainder in a natural state; other areas are bare with exposed outcrops of basalt, others are partially covered with mixed species groundcover, low-growing brush and shrubs. The south and southwest areas host moderate stands of pine and fir.

Several dirt roads are present on the site, most notable is a dirt access road for the Watters residence that cuts diagonally across tax lot 300. Several other roads branch off the Watters residence road; one dead ends at the cemetery located on the north property boundary. Most of the roads access the northern and eastern portions of the property. The Watters residence access road will eventually be relocated as mining progresses southward.

4.0 GEOLOGIC CONDITIONS

The site lies within a geomorphic feature referred to by Swanson, et al, 1993, as the Portland Basin, a northwest-southwest trending sediment-filled structural depression. The basin is about 20 miles wide and 45 miles long and contains rocks that are late Miocene(?), Pliocene, and Pleistocene in age. Rocks underlying Watters Quarry are considered part of the Columbia River Basalt Group (CRBG) of middle Miocene age. Locally, the CRBG are mostly massive, thick flows comprised of dark grey to black, unaltered basalt. Exploration drilling at the site indicate a minimum basalt thickness of 300 feet (CES Report, 1992). Gray, et al, 1978 state that this unit produces some of the better grade rock material for construction purposes. Uses include embankments, topping, subbase, base, rip-rap, and concrete. The 1992 CES Report contains quantity and quality test results and drilling information for the site.

Soils present at the site consist of "rock outcrop - Xerumbrept complex, undulating, Class VII series Soil Conservation Service type. Rock outcrops are predominant south of the Watters residence access road. A thin veneer of soil develops southwest of the road and thickens toward the southwest corner of the property. Thicker soils in the southwestern portion support moderately forested areas.

5.0 MINING OPERATIONS

Current mining operations at the Watters Quarry are located in the northeast corner of the property. The rock crushing plant and support facilities are situated within the existing pit. Administrative buildings are located adjacent to Highway 30 near the quarry entrance.

Proposed mining operations include mining, crushing, screening and stockpiling aggregate at the site over a 30 year period. The proposed mining plan will result in the removal of an estimated 31,000,000 cubic yards of material of which 380,000 cubic yards will be topsoil and overburden assuming an average of 2 foot of overburden above the basalt. Total volume of basalt resource is estimated to be 30,620,000 cubic yards. Drill and blast mining methods will be employed to develop multiple benches. Processing will be dry.

Proposed mining plans show that the quarry will be mined from the northeast towards the southwest. All crushing operations will be contained within the existing quarry. Existing

vegetation will be preserved as a visual and sound buffer around the perimeter of the site. A moveable chain link fence with posted warning signs will be erected around mined areas of the quarry. In addition, existing topography will effectively screen the visual impacts of the mining operation and control noise that would affect adjacent properties. Soil and crushed rock berms will also be utilized as sound and visual screens. A 50 foot-high slope along much of the eastern side of the property will be preserved to screen for noise and sight.

As mining advances, overburden will be removed and stockpiled at various locations around the site but will not be located closer than 25 feet from property boundaries. Overburden berms intended for reclamation will be contoured to blend with local topography and will be protected from erosion by seeding with native grasses.

6.0 RECLAMATION

The goal of the reclamation plan is to create stable, usable land after mining ceases. The reclaimed area will appear natural with an undulating topography, and native vegetation that blends with the surrounding landforms and environment. Additional reclamation information is included in Appendix C.

The reclamation plan proposes reclaiming the mined area by creating a large lake surrounded by mixed vegetation. The lake and surrounding wooded area will create a mixed use for natural wildlife habitat and recreation.

Morse Brothers proposes using a "segmental reclamation strategy" (Norman and Lingley, 1992). Segmental reclamation involves reclamation following completion of mining in individual sectors of the mine. Instead of progressive reclamation where the reclamation activities can interfere with active mining, segmental reclamation is designed to efficiently remove the resource and begin reclamation only when mining activities are relocated to another area. The goal will be to establish a self-sustaining soil/plant ecosystem segmentally while not interrupting mining processes.

Reclamation will begin by stockpiling topsoil in strategic areas within the permit area. The soil will be quickly re-vegetated to preserve the soil structure and prevent erosion. As areas are mined, topsoil will be spread in thicknesses similar to original conditions. For optimum effectiveness, the soil will be spread no thinner than 8 inches over approximately 3 feet of subsoil. When necessary, erosion mats will be used until vegetation stabilizes the reclaimed areas.

After spreading and contouring, native vegetation will be replanted. Vegetation will include a variety of grasses, legumes and other native groundcovers mixed with shrubs and trees.

A 200 foot setback along property boundary lines will surround the mine permit area. In addition, a minimum of a 25 foot wide border of native vegetation will be left permanently around the mining permit area. The setback and native vegetation will serve as a protective buffer to screen noise generated from mining activities and to visually enclose the mining operation.

Final slopes will be a maximum of 2:1. In order to vary the topography, steeper slopes will be created locally. Horizontal surfaces will be gently sloped into the hill to hold soil and to prevent water erosion on cliff faces. Soil will be replaced, contoured and replanted using the segmental reclamation strategy. Soil movement, spreading and contouring will be planned for dry seasons; late spring through early fall. Planting will be done at advantageous times during increased rainfall to insure maximum plant survival and eliminate the need to irrigate.

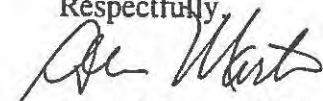
Reclamation will include drainage design to control erosion and maintain water quality flowing offsite. Water flowing across the site will be controlled in a system of drainages or ditches. Drainages will pass through vegetated areas designed to slow runoff and filter muddy water. During mining, drainages will flow into a series of settling ponds. Water flowing out of siltation ponds will be additionally filtered by flowing through french drains and drop structures constructed to control erosion and trap sediments. The final reclamation will leave a large lake as the focal point in the area. Established drainages will be directed into the lake and by the final stage, vegetation should be well established in the drainages to trap sediment and prevent erosion.

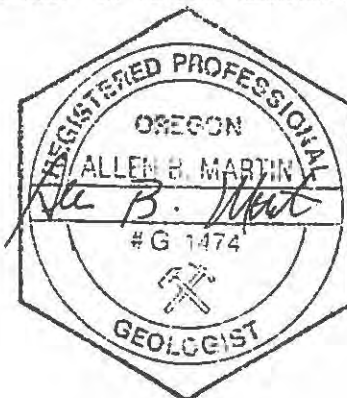
Overburden and waste rock remaining after mining ceases will also be incorporated into the reclamation plan. Creating a natural, varying topography will require thicker subsoil or overburden. In addition, large blocks can be employed in the landscape to establish natural topography breaks and used in the lake to create an irregular lake floor conducive to aquatic life.

As explained previously, reclamation will occur in segmental stages as mining advances. As an integral part of the reclamation plan, wildlife specialists, foresters, nurseries, and other environmental professionals will be consulted to assist with relevant reclamation projects.

Environmental Science Associates, Inc. appreciates the opportunity to assist Morse Bros., Inc. with the Watters Quarry Reclamation Plan. If further assistance is required, we would be pleased to offer our services.

Respectfully,


Allen Martin, RPG



7.0 REFERENCES

Oregon DEQ Document No. IW\WC11\WC11727.5: Recommended Best Management Practices for Storm Water Discharges, August, 1993.

Norman, David K., and Lingley, William S. Jr., 1992, Reclamation of Sand and Gravel Mines; Washington Geology, vol 20, no. 3.

Norman, David K, 1992, Reclamation of Quarries; Washington Geology, vol. 20, no. 4.

Swanson, R.D., et al, 1993, A Description of Hydrogeologic Units in the Portland Basin, Oregon and Washington, USGS Water-Resources Inv. Report 90-4196.

LaFranchi, Steve, 1992, St. Helens Conditional Use Application - Geologic Review, Cascade Earth Sciences, Ltd. Report.

8.0 RESOURCES

Genesis Turfs & Forages - (801) 745-4609

Grassland West Co.- (800) 582-2070

North American Green - (800) 878-5115

Balance Restoration Nursery - (503) 942-5530

Skagit Conservation District - (206) 428-4313

COLUMBIA COUNTY
LAND DEVELOPMENT SERVICES

Courthouse
St. Helens, Or 97501
(503) 397-1501

RECLAMATION PLAN FOR OPERATING PERMIT NUMBER CU 22-92 for tax lots 1600/400; tax lot 300 zoned SM.

A. Name, Address and telephone number of the Permittee:

MORSE BROS., INC. (503) 928-6491
32260 Old Highway 34
Tangent, Oregon 97389

B. Name, Address and telephone number of all landowners within the permit boundary:

J.H. & D., Inc.
Watters Concrete, Inc.
P.O. Box 405, St. Helens, OR. 97051

C. Name, address and telephone number of all mineral rights owners if different from the landowners listed in question B:

D. Legal description of permit boundary including Tax Lot Numbers, Sections, Township, Range Wm.

Tax Lot Number north portion of 400 Section 32 Township 5 North Range 1 West
Tax Lot Number north portion of 1600 Section 33 Township 5 North Range 1 West
Tax Lot Number 300 Section 33 Township 5 North Range 1 West

E. Zoning on Tax Lots listed in question D:

Tax Lot Number 400 and 1600, Zoned PF- 76
Tax Lot Number 300, Zoned SM

F. Number of acres in permit boundary: Total of approximately 204 acres of which 120 acres are in tax lots 400/1600 and 84 acres in tax lot 300.

G. Exempt ground claimed in permit boundary (ie: ground mined prior to 1972). Exempt ground claimed: 84 acres on tax lot 300.

H. Explanation of exemption claimed:

Mining was initiated before 1972 as evidenced by aerial photographs in Appendix.

I. Pre-Mined Conditions

1. Current land use: tax lots 400/1600 are unused and tax lot 300 is being mined.
2. Type and density of vegetation: Varies from bare rock outcrop to moderately timbered.
3. Depth of topsoil: The eastern portion of the permitted area is bare outcrop and the western areas have up to 60" of topsoil.
4. Depth of overburden or waste rock that will have to be removed: No overburden is present along the eastern margins and up to five feet of overburden may be removed from the westernmost.
5. Are there any drainages in the permit boundary? Yes No
6. Are there wetlands in the permit boundary? Yes No

J. Mine Plan

1. Mining Method to be employed: Drill and blast
 - a. Single Bench
 - b. Multiple Bench
 - c. Side Hill Cut
 - d. Pond Excavation
 - e. Placer Mine
 - f. Other
2. Will blasting be incorporated into the mining operation? Yes No
3. Distance to the nearest non-owned structure from the mining operation (ie: house, well, garage, etc.) Watters residence is approximately 400 feet from proposed mining area.
4. Are there any property lines within 500' of the mine area? Yes No
5. Type of vegetation and removal method: Conifers that have commercial value will be logged by property owner, ground cover will be cleared.
6. Topsoil salvage depth: Fertile topsoil, possibly up to 30" deep, will be stockpiled to be for used for reclamation.
7. Will overburden stockpile or spoil locations be created by the mining operation?
Yes No
If yes, what is the estimated volume (s)? 379,937 cubic yards.
Additional information may be required if spoil dump is located on steep slopes or large volumes of material.
8. Approximate min depth: 250 feet below surface.

9. Approximate depth to groundwater: Estimated from nearby well logs to be between 80 and 160 feet below surface.

10. Is there a well or wells on the property? Yes ___ No X

Please state the distance to the closest well to the mine area. Unable to determine the location based on incomplete well completion logs.

11. Will the mine site dewatering be required? A permit may be required from the Water Resources Department for the dewatering activity. Yes ___ No X

12. Will waste water be contained on-site in a pond or discharged off-site? A permit from the Department of Environmental Quality may be required for waste water control facilities.

Yes ___ No X

13. Please explain discharge for containment procedures for the mine site dewatering. See plan text, also DEQ Storm Water Permit #108484.

14. List types of equipment to be used for mining and processing.

a. Mining Equipment:

b. Type of Processing (check one)

___ 1. Wash water will be discharged off-site.

___ 2. Wash water will be contained in a closed system.
Source of water?

X 3. Dry processing.

___ 4. No on-site processing.

K. Post-Mining Land Use

What will be the planned subsequent beneficial use of the permit area? The planned subsequent beneficial use must be compatible with local zoning requirements. Examples include grazing, wildlife, wetlands, timber, etc. Land within the permit boundary is zoned PF-76, SM. Each area will comply with the unique zoning requirements.

L. Reclamation Timing

Columbia County Surface Mining Ordinance requires that reclamation be completed within three years following completion of mining.

1. Reclamation will begin 30 days after mining is completed.

2. Reclamation will be concurrent with mining: Yes X No

Please explain procedures for concurrent reclamation: As mining progresses, mining benches will be no steeper than the prescribed 1 1/2:1 slope requirements above water level. Areas where mining is completed will be covered with topsoil and seeded to introduce native vegetation and control erosion. If necessary, other erosion controls such as erosion mats, will be used on a temporary basis until a groundcover is established.

M. Surface Water Management

1. How will surface water runoff through the permit area be handled during mining? Surface water runoff will be collected in one or more settling ponds located within the permitted area. Treated water will be allowed to flow offsite through a channel system designed to control erosion and siltation.
2. What will be the minimum undisturbed setback of the operation from any stream or drainage? Streams or drainage are not present in the vicinity of the permitted area.
3. Describe methods employed to control erosion and sedimentation in the permit area. Be specific, i.e., seeding and mulching stockpiles on bare areas, contour ditching, waterbars, etc. Erosion related to soil stockpiles and bare ground will be controlled by seeding and mulching with effective groundcovers, or using erosion control mats. If existing vegetation can be preserved, it will be maintained to control erosion. Erosion related to sheetflow across bare ground will be controlled by creating drainage ditches lined with vegetation or structural controls designed to trap sediment, reduce stream energy, and allow for settling of turbid runoff.
4. Will settling ponds or dams be constructed? Yes X No
 - a. Please state size of the impoundment(s) and how they will be created. Will the pond be excavated or will berms be constructed? Size will vary depending on location and number(s) of ponds needed to capture runoff and control siltation. The ponds will be created as a result of mining excavation.
 - b. If a dam will be constructed, how high will it be? If a dam is higher than 10' or stores more than 9.2 acre feet of water, approval from the Water Resources Department is required. No dams needed at this time, only settling ponds.
 - c. If berms or a dam will be constructed, please describe construction details and attach a sketch showing construction methods. Not applicable.
 - d. How deep will the impoundment be? Settling pond 4' deep.
 - e. If the impoundments are to be removed upon completion of mining, how will the ponds be drained or filled? Drain through permanent settling ponds, discharged to the drainage channel offsite.

- f. Is (are) settling pond(s), wetlands, or a water impoundment to be left upon final reclamation?

Yes X No

N. Visual Screening

Visual Screening can be very effectively employed to hide sites from public notice.

1. Does natural landform or vegetative screen presently exist along the permit boundary?
Yes X No
2. If yes, how will the screen be maintained during mining? Visual screens will be maintained by designing mining development to preserve the prescribed width (twenty five (25) feet) of existing vegetation. In addition, introduced vegetation will be maintained with additional seeding, mulching, and plantings when necessary and irrigation if necessary.
3. How wide is the screen? Visual screens will be no less than twenty-five (25) feet wide.
4. Will a berm and/or vegetation be established to develop a visual screen for the operation?
Yes X No

If yes, please describe height, width, location of berm and type and density of vegetation. Berms will be placed where necessary as mining progresses. The screens will be designed to act effectively as visual or sound buffers to insulate mining activities.

O. Noise Screening

Topsoil or overburden berms can be very effectively employed in certain situations to dissipate crusher noise, Will noise berms be constructed for this operation?

Yes X No

If yes, show the berm location on the site map. Also, please describe height and width of the berm. Sound berms will be constructed from available soil and rock. Vegetation will also be incorporated to control sound generated by mining activity. Soil/rock berms and vegetation-covered berms will be incorporated when necessary to control any noise generated by the mining operation. Construction will be completed to the highest standards to accomplish the objective and will depend on the location.

P. Equipment and Structures Removed

Upon final reclamation, will all structures, equipment and refuse be removed from the site?

Yes X No If no, please explain.

Q. Map or Aerial Photo Requirements

A mine plan map is required. It can be an aerial photo, blue line copy of an aerial photo, an engineered drawing or a properly scaled hand drawing.

1. Map(s) requirements include, but are limited to:
 - a. Scale (1" = 100' to 600')
 - b. North shall be indicated.
 - c. List the appropriate legal description(s) and, if practical, the tax lot numbers.
 - d. The boundaries of area to be permitted and any setbacks for the excavation area.
 - e. The location of the plant, office and maintenance facilities.
 - f. The locations of all water courses, streams, rivers, springs, and wells.
 - g. The present mine areas and future mining blocks, if known.
 - h. The area(s) for topsoil and overburden storage.
 - i. The locations of all proposed access roads.
 - j. All property lines in the permit area and within 500' of the permit boundary.
 - k. The location of the mine, processing and stockpile areas plus visual and sound berms.
 - l. The date of map preparation and the name of the person preparing the map.
2. Pre-and Post-mining cross-sections of the land surface may also be required.

R. Reclamation Procedures

1. Land Shaping

- a. What will be the steepest above-water excavated slopes left after mining (1-1/2:1 is the general maximum)? 1 1/2:1 will be the maximum slope.
- b. What will be the steepest above-water fill slopes left after mining (2:1 is the general maximum)? 2:1 slopes will be the maximum slopes present after mining.
- c. Describe how adjacent property will be protected against steep banks, deep holes or other hazards during and after mining. Adjacent property will be protected against any hazards by maintaining safely engineered slopes and access will be restricted by installing chain link fence around extraction area.
- d. What is being done to ensure slope stability? After removal of overburden, slope engineering will regularly review mining faces to ensure slope stability to protect mine personnel and equipment and to preserve land on the perimeter of the mining operation.

Excavated slopes: Excavated faces will not be steeper than 1 1/2:1

Fill slopes: Slopes filled for reclamation will not be steeper than 2:1

2. Revegetation Techniques - Vegetative survival at least equal to the original ground cover will normally be considered acceptable. This may take three or more years to complete.

a. How and where will soils or subsoils be stored for reclamation? Fertile topsoil removed as mining advances will be stockpiled at accessible locations on the perimeter of quarry. Soil stockpiles will not be placed closer than twenty-five (25) feet from any boundary line.

b. What measures will be taken to reduce compaction, prevent water and wind erosion of the stockpiles? Stockpiles will be protected from compaction by placing them out of traffic areas. Groundcover or covering with protective matting will be used to prevent wind and water erosion.

c. Toxic materials at the site: How will toxic materials be handled if any? Toxic materials will not be handled at the site.

d. What will be the average depth of soil replaced on the area to be reclaimed? Reclaimed areas will be covered with topsoil varying in depth from bare ground to approximately 30" deep. Depth of topsoil will be designed to ensure that re-introduced vegetation can be supported. Varying topsoil thickness will simulate original appearance of the site before mining to create a more natural environment once vegetation is re-established.

e. Will additional material be utilized as a soil substitute to complete the revegetation? If necessary, biodegradable mats may be used to help establish vegetation in difficult areas.

f. Will any waste products, such as tailings, crusher rejects, etc., be generated during mining?

Yes X No

If yes, what will be done with them? Any waste products generated from rock material will be left onsite. The material will be contoured in such a way to simulate a natural landscape similar to conditions present before mining.

g. Describe seedbed preparation methods prior to planting. Fertile topsoil will be applied in thicknesses sufficient to support intended vegetation. If necessary, soil placed on slopes or benches may require temporary stabilization measures until vegetation becomes established.

h. List species to be seeded and/or methods planted by type and amount. Native perennial grasses and groundcovers will be used. Planting densities for individual species prescribed by the USDA Soil Conservation Service will be followed.

i. Describe planting method and the time of year for the planned planting. Planting for reclamation will be done as mining proceeds. Methods will be either by hand

or with machines. Timing will be based on optimum dates for the type of plants or trees chosen. typically the fall or spring when watering will not be necessary.

- j. List types and amounts of fertilizer, mulch and lime to be used to supplement the seeding. Fertilizer, mulch or lime will not be used.
3. State disposition of all stockpile sites upon final reclamation. If they are to be revegetated, explain procedures which will be employed to decompact the area prior to topsoiling and seeding. Stockpiles remaining after filling mined areas will be contoured to blend into the surrounding topography. If necessary, any compacted material will be ripped to a sufficient depth, graded and contoured prior to covering with topsoil and seeding.
4. If applicable, what provisions have been made for stream channel and bank stabilization and rehabilitation? (A division of State Lands' permit is generally required for stream relocation.) Not applicable.
5. What provisions will be made to control surface water runoff and erosion through the permit area upon completion of mining? Surface water runoff and erosion controls will be established during mining and will be left in place after completion of mining. Any additional areas prone to erosion will be seeded to re-establish groundcover. Areas susceptible to sheet flow will be protected by constructing natural-appearing channels stablized with vegetation or erosion-control structures.
6. Will dewatering be required to complete reclamation? Yes ___ No X
- Will backfilling a water filled excavation pit or pond be completed during reclamation? Yes ___ No X
- Will off-site materials be imported to complete the backfilling? Yes ___ No X
- If yes, how will quality of imported backfill be monitored to protect groundwater quality? Monitoring or testing may be required to ensure groundwater protection.

S. Other Permits if available

	Permit Number	Date Permit Issued
Division of State Lands	_____	_____
Dept. of Environmental Quality	<u>1200-A</u>	<u>10/25/94</u>
County Land Use Permit	<u>CU 22-92</u>	<u>7/17/92</u>
Water Rights	_____	_____
Other (identify)	_____	_____

NOTE: MAPS OR SKETCHES EXCEEDING 11" X 17" MUST BE PROVIDED IN SUFFICIENT NUMBER REQUIRED FOR DISTRIBUTION.

(Coordinate with Reclamationist or Mined Land Reclamation Office before submission)

T. Post-Mining Water Impoundments

1. Number of impoundments: Water impoundments will be left to restore a natural setting and create an environment conducive to sustaining native plant and animals. The number of impoundments necessary is estimated to be at least one and possibly three ponds.
2. Total surface area in acres: Ponds and wetlands acreage will be approximately ten to fifteen acres.
3. Average depth: Depth will be greater than eight (8) feet below low water mark to avoid stagnant water.
4. What will be the steepest in-water slopes left after mining? (Generally 3:1 in-water slopes are the steepest allowable.) Below-water slopes will be one of two scenarios: (1) A 3:1 slope to a depth of at least 6 feet below low water mark: or (2) safety benches at least 2 feet below low water and at least 5 feet wide may be substituted for slope requirement.
5. Will any shallow ponds, shorelines, or other areas conducive to wetland plant development be left after mining? Yes, shallow ponds will be incorporated into the reclamation plan which will include irregular shorelines bordered by wetland areas conducive to a variety of wildlife habitat.
6. What is the water source for the impoundment? Water captured from surface water runoff and any naturally-occurring springs or seasonal drainages.
7. How will stagnant water be prevented in water impoundment? Water depth will be at least eight (8) feet.
8. What will be done for wildlife and fish enhancement (islands, peninsulas, irregular shorelines, fish structures)? Overall, the objective of the reclamation plan is to simulate a natural setting conducive to attracting and sustaining wildlife and fish. To meet that goal, varied native vegetation, contoured topography, ponds, irregular shorelines, and wetland areas will be utilized to create a visually attractive package that blends with the undisturbed surroundings.

U. Landowners Consent

As surface or mineral rights Owner, I concur with the proposed subsequent use for any mining operation and with the operating and reclamation plan as submitted. I also agree

to provide access to the Columbia County Land Development Services or their contractor for reclamation of the mine site if it is declared abandoned by Columbia County.

I CONCUR (Surface Rights):

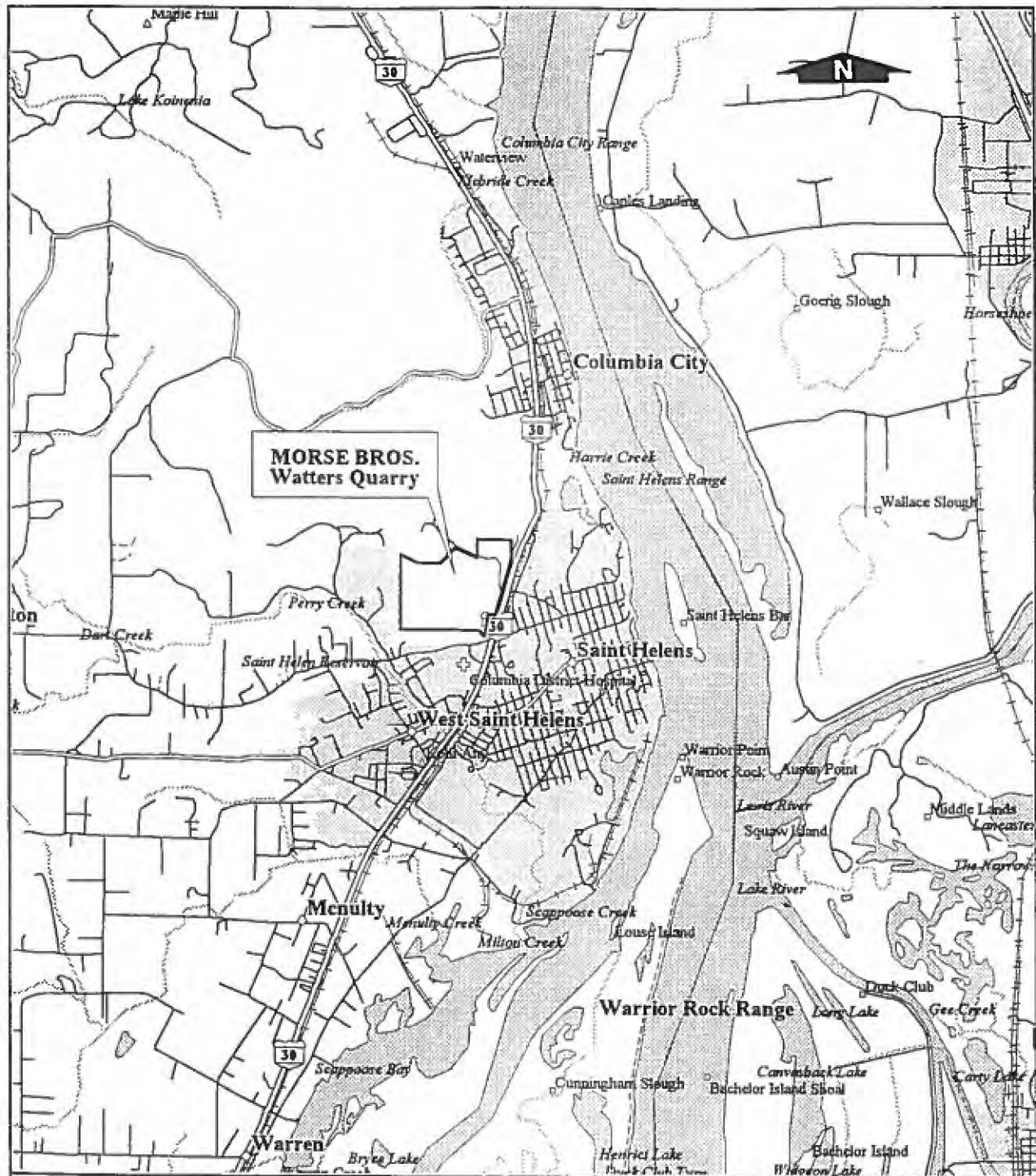
<u></u>	<u>Pres.</u>	<u>2-16-97</u>
Signature	Title	Date

I CONCUR (Mineral Rights):

<u> Lessee</u>	<u>Asset Mgr., Morse Bros.</u>	<u>7/25/95</u>
Signature	Title	Date

V. Applicant's Acceptance

<u></u>	<u>Asset Mgr., Morse Bros.</u>	<u>7/25/95</u>
Signature	Title	Date

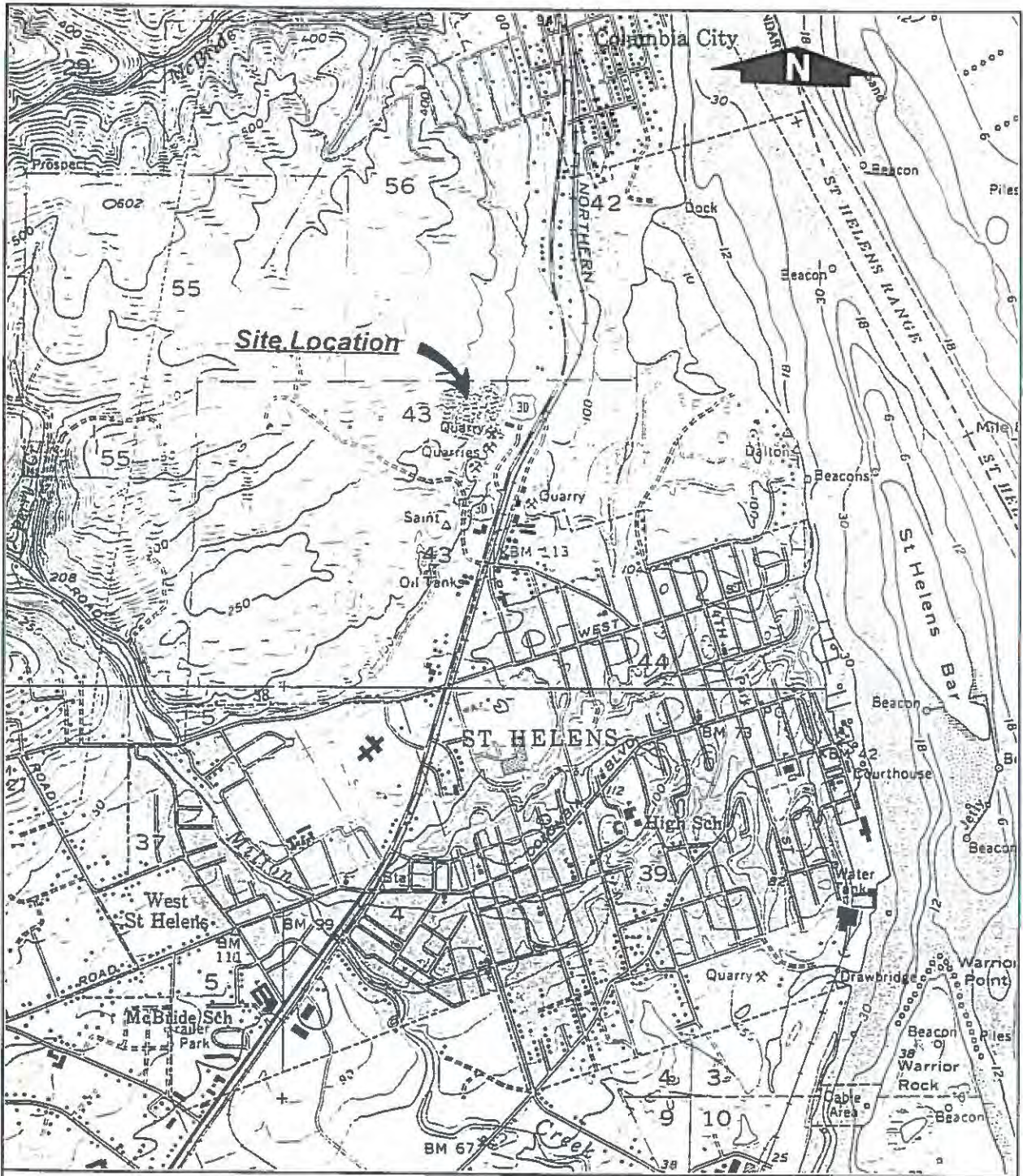


**MORSE BROS.
Watters Quarry
Columbia County, Oregon**

**SITE
LOCATION
MAP**

Scale: 1:62,500

Source: Source: DeLorme Mapping 1993



RECLAMATION PLAN
Watters Quarry
Columbia County, Oregon

TOPO
MAP

Scale: 1" = 2000'
 Contour Interval: 20 feet

Source: 7.5 USGS St. Helens 1976,
 photorevised 1986



Watters Quarry
Highway 30
St. Helens, Oregon

1994 AIR PHOTO

Scale: unknown

Source: Company Files
Reference: 9-5-94 750 C-MBSG-WQ-1

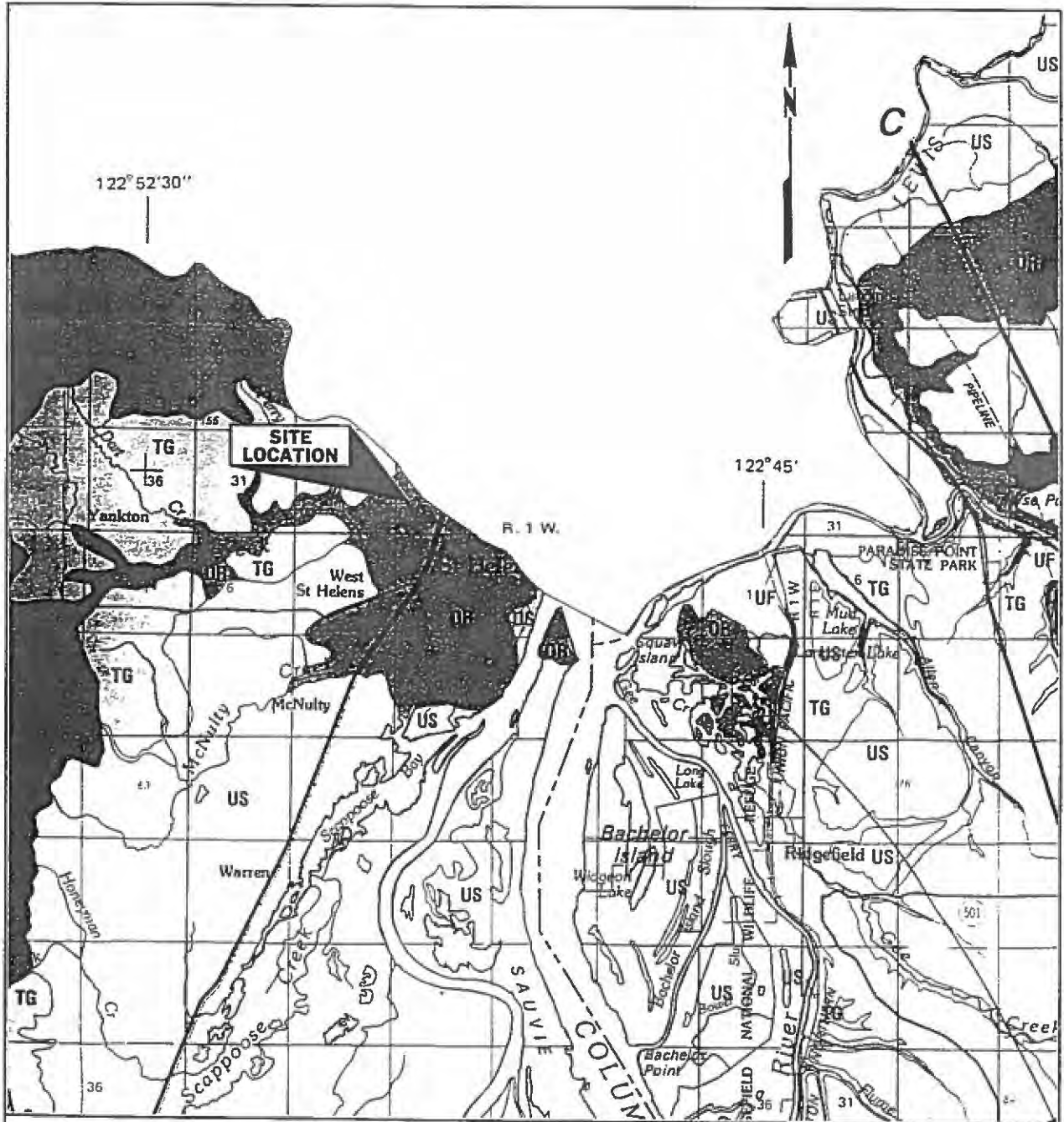


RECLAMATION PLAN
Watters Quarry
Columbia County, Oregon

1953 AIR PHOTO

Scale: unknown

Source: U of O Map Library
Reference: 9/9/1953 ASCS BAS 1M(65)



EXPLANATION

OR: Older Rocks consisting locally of Columbia River Basalt Group
 US: Unconsolidated Sedimentary Aquifer - alluvium and Pleistocene flood deposits

**RECLAMATION PLAN
 Watters Quarry
 Columbia County, Oregon**

GEOLOGY MAP

Approximate Scale: 1" = 13,200'

Source: USGS Water-Resources Inv. Report 90-4196
 Plate 1



WASHINGTON GEOLOGY

Washington Department of Natural Resources, Division of Geology and Earth Resources

Vol. 20, No. 4, December 1992



Some effects of the April 1992 earthquakes in northern California. The photo above shows one of the many homes in Ferndale, CA, knocked from its foundation. The photo on the left shows the distinct line between live (dark color) and dead (light color) seaweed in an area near Cape Mendocino that experienced a meter or more of uplift. The tide now reaches only to the top of the dark area. One or more of these earthquakes may have occurred along the Cascadia Subduction Zone, which is also present off the coast of Washington. See article, p. 10.

INDEX ISSUE (See p. 23)

In this issue: reclamation of quarries, p. 3; Effects of Eocene and modern earthquakes in northern California, p. 10; The role of the Washington Division of Geology and Earth Resources Library, p. 16; Progress report on the State Geologic Map, p. 19; New language relating to holding fees for unpatented claims, H.R. 5503, 1993 appropriations for the U.S. Department of the Interior, p. 21; Selected additions to the library of the Division of Geology and Earth Resources, p. 22.

Reclamation of Quarries

by David K. Norman

Quarried rock is consolidated material mined by blasting, ripping, or cutting. Rock types commonly quarried in Washington include basalt, andesite, granodiorite, limestone, dolomite, and, in the past, sandstone. When operations cease, unreclaimed working faces and engineered benches can be obtrusive, unsafe, liable to erode, and aesthetically unpleasant. However, reclaimed quarries can create spectacular landscapes and add to the variety of landforms in an area.

Washington's Surface Mining Act (Chapter 78.44 RCW), which is administered by the Department of Natural Resources, defines reclamation as "the reasonable protection of all surface resources subject to disruption from surface mining and rehabilitation of the surface resources affected by surface mining including the area under stockpiled materials. Although both the need for and the practicability of reclamation will control the type and degree of reclamation in any specific instance, the basic objective will be to *reestablish on a continuing basis the vegetative cover,*



Figure 1. A reclaimed quarry in mountainous terrain. Naturally hazardous conditions (cliffs) are present in the immediate area. Chutes, spurs, scree slopes, and soil on the slopes have created a natural appearance. Trees have grown on the slope where soil is located and complete the reclamation. The site will be used for forestry in the future. Note person (mid-slope) for scale. Photo by M. A. Shaaver.

soil stability, water conditions, and safety conditions appropriate to the intended subsequent use of the area. [emphasis added]. RCW 78.44 also states that "the slopes of quarry walls in rock or other consolidated materials shall have no prescribed angle of slope, but where a hazardous condition is created that is not indigenous to the immediate area, the quarry shall be either graded or backfilled to a slope of one foot horizontal to one foot vertical or other precautions must be taken to provide adequate safety" (RCW 78.44.090 (4)).

The goal of RCW 78.44 is that reclamation create stable, usable land at a mined site. The reclaimed quarry should appear natural, that is, slopes should be sinuous and right-angle corners should be rounded. The height and angle of some working quarry faces need not be reduced if there were tall cliffs in the area prior to mining (Fig. 1). Subsequent uses of a quarry will be constrained by its post-mining topography. For example, cliffs are appropriate if the subsequent use of the pit floor is forestry or grazing and it is in a mountainous area.

Several methods of reclamation can be used to convert a quarry into a stable site that blends with surrounding landforms at a minimum cost. This article introduces some of these methods. It is a companion to "Reclamation of sand and gravel mines" (Norman and Lingley, 1992), which discusses strategies for topsoil replacement, revegetation, and various subsequent uses that will be applicable in many quarries. As with sand and gravel pits, the strategy of choice for quarries is segmental reclamation. These similarities notwithstanding, the differences in approach to reclaiming sand and gravel pits and quarries are distinct enough to warrant this separate discussion.

RECLAMATION PLANS

Quarry operators should prepare and follow a detailed and effective operating and reclamation plan. This plan should be simple, practical, and easy to implement. The plan should also be flexible and take into account both market changes and the potential for unanticipated changes in geologic conditions that will affect reclamation. In addition, the plan should make provision for high-quality reclamation, even if mining to depletion does not occur. Managers and senior equipment operators must be familiar with the reclamation plan and the obligations to which the permit holder has committed.

A typical operation and reclamation plan might include

- A map showing existing topography, hydrology, and details on how the site will be mined and whether it will be left wet or dry
- Information about subsequent use of the land, appropriate for the location of the quarry
- An indication of the sequence of topsoil stripping, storing, and replacement on mined segments
- A map showing direction and sequence of excavation for prompt reclamation after mining on any segment and within the constraints of economically efficient mining

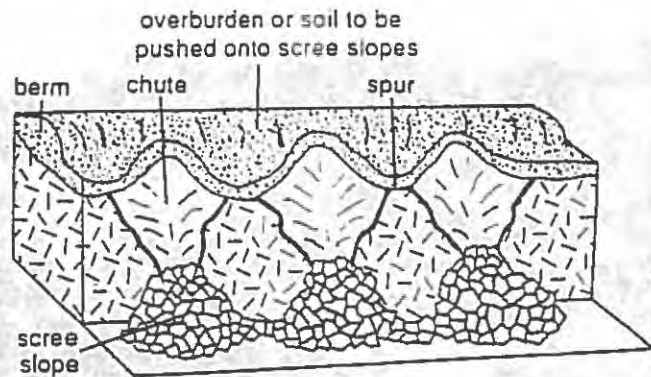
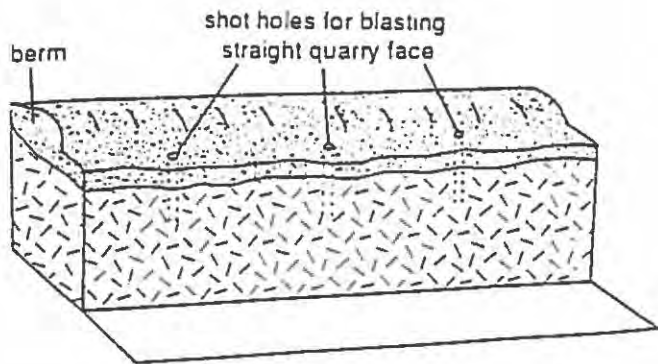


Figure 2. Selective blasting (top) can produce a natural appearance by eliminating right-angle corners, straight lines, and flat surfaces. The resulting scree slopes (bottom) provide a suitable medium for revegetation when soil is pushed onto them.

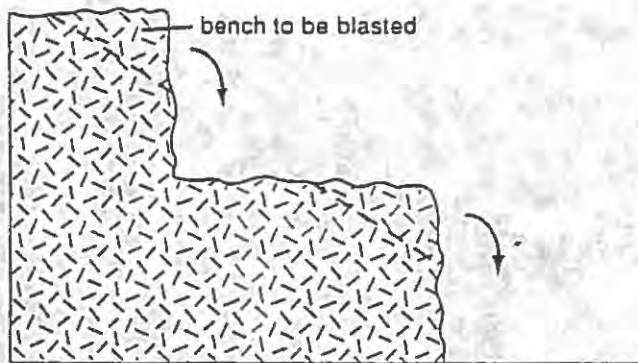


Figure 3. Blasting (top) can reduce or remove benches and create scree slopes (bottom) that can be further stabilized by plantings.

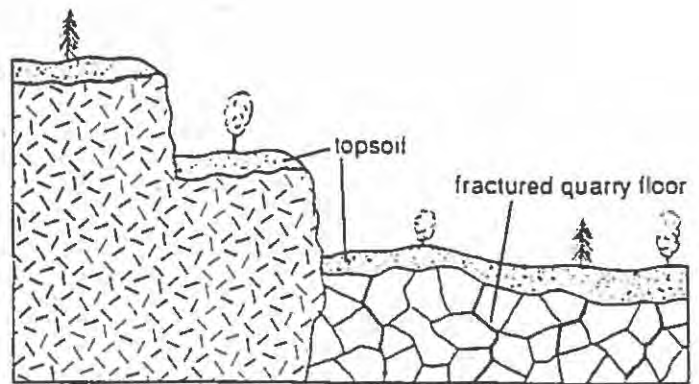


Figure 4. Topsoil placed on benches and on a fractured quarry floor will make the site look natural and prepare it for revegetation.

- Designation of overburden storage areas beyond the limit of mining but positioned for the shortest possible downhill transport during reclamation
- Location of waste rock piles and information on how they will be reclaimed and stabilized
- A map showing the final grades and shapes of quarry walls and floor, incorporating sinuous contours
- A description of surface-water drainage, water diversions, and any subsequent restoration of drainage that may be necessary
- Information about the location and construction of permanent drainage and water-control systems
- Specifications and planting schedules for ground-cover plants to minimize erosion and establish conditions that will increase survival rates of other vegetation and trees
- For areas where trees can be planted, planting specifications, and schedules to make use of the new humic layer generated by ground cover
- Other information pertaining to the conditions on the mining permit and required by statute.

Quarries have impermeable surfaces, such as their floors, a characteristic that can lead to rapid runoff rates. Water-control methods must ensure that erosion does not take place in the quarry or where the runoff leaves the site. Water and erosion control is an important aspect of the operation and reclamation of quarries and is discussed widely in the literature (Washington Department of Ecology, 1992; Banks and others, 1981; Amimoto, 1978; Foster, 1991; Goldman and others, 1986; Gray and Leiser, 1982). It will not be discussed in detail in this article.

RECLAMATION TECHNIQUES

Highwalls and Benches

Several methods of reclaiming quarry walls are effective in achieving stable slopes and land that can be used after the quarrying operation ceases. Shaping the tall rock faces and engineered benches created during production blasting can be particularly difficult. Selective blasting is one method of producing the desired natural appearance and stabilizing a site. If cliffs will be part of the final configuration of the reclaimed quarry, then chutes, spurs, scree slopes, and rough cliff faces can be created by blasting in strategically

placed holes. The result will be elimination of flat surfaces (Fig. 2) (Coppin and Bradshaw, 1982). Proper blasting of highwalls leaves rough surfaces that can provide habitat for birds such as cliff swallows. However, the remaining rough surface should be free of loose rock.

If highwalls are part of the reclaimed configuration, rounding the top edges of the quarry, creating a 10-foot-high by 15-foot-wide bench, or placing a berm at the top of the quarry (Fig. 2) will improve safety by slowing access and reducing the effective height of the final face.

Selective blasting can also be used to reclaim benches (Fig. 3) that may otherwise be obtrusive and not blend with natural surroundings. However, if blasting of benches is impractical or dangerous, the benches that remain should be about 40 feet wide to accommodate revegetation. The surface of these benches should slope toward the highwall to trap the moisture and fine particles that will enhance revegetation. At least 3 feet of topsoil should be placed on the inside part of the bench to serve as a stable rooting medium. Trees planted on these benches or elsewhere on a highwall will break up the line of the face and conceal rectilinear features (Figs. 1, 4).

Reclamation blasting (also referred to as blast casting) that reduces the entire highwall to a scree slope or an overburden slope is in essence a cut-and-fill method. However, this process can be used only if there is sufficient material remaining in a setback behind the quarry face to create the desired slope. Mining past these setbacks is not permitted by the Department.

Blasting to eliminate an entire highwall uses a pattern of progressively shallower holes—that is, if a highwall is 60 feet high and the desired slope is 3H:1V, the blast holes closest to the highwall face should be drilled 30 feet deep, or half the height of the highwall. The second, third, and fourth rows away from the face should be drilled to depths of 25, 20, and 15 feet, respectively (Fig. 5); the row of holes extends 90 feet back from the highwall. This method of creating slopes is usually more economical than backfilling (Thorne, 1991; Petrunyak, 1986). Blast casting may not work in overburden that has been moved because shot holes may not stay open in unconsolidated materials.

At some quarries, blasting to reduce the exposed highwall is not recommended because the resulting increased surface disturbance may cause unexpected slope failure on adjacent land. Therefore, the impact of blasting the highwall should be carefully considered when preparing the operating and reclamation plan (U.S. Bureau of Land Management, 1992).

Backfilling against a steep quarry wall using either material on the site or imported material is generally not

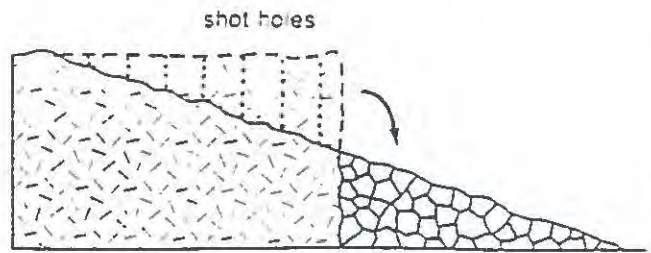


Figure 5. Shot holes drilled to progressively shallower depths provide a blast pattern that will reduce highwall height, create a 3H:1V slope, and prepare the quarry site for revegetation.

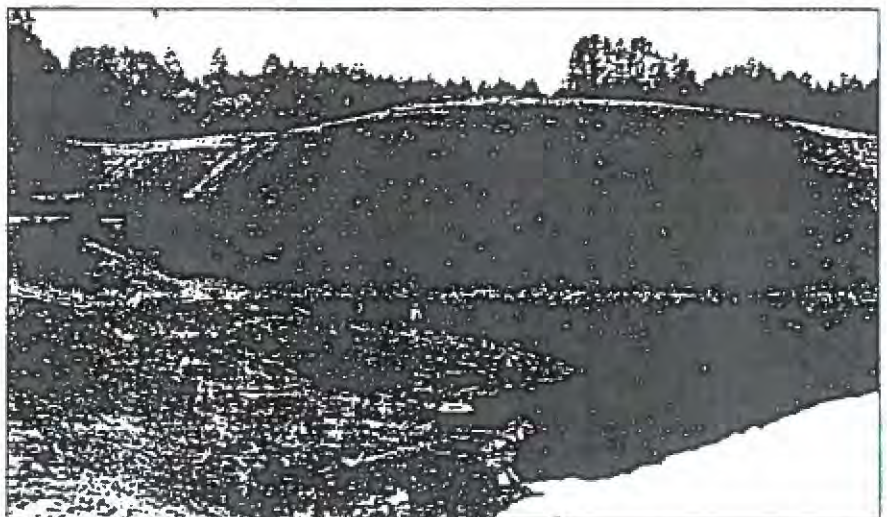
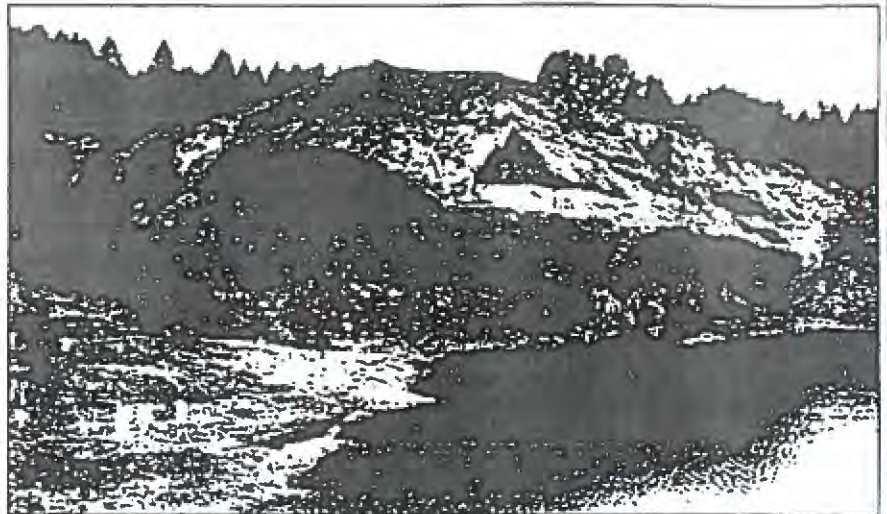


Figure 6. In the top photo, overburden is stacked on top of a highwall left by mining, ready to be bulldozed into position. The short push will reduce the cost of reclamation. In the bottom photo, moving of overburden into position for reclamation is nearly complete. Overburden has been pushed over the highwall with a bulldozer. Blast casting was attempted here to reduce costs; however, the shot holes could not be kept open because the overburden is unconsolidated. The final reclaimed slopes allow easy escape from the pond and will be revegetated. Lower photo by M. A. Shawver.

recommended for reclamation. Backfilling will be cost effective only if enough appropriate overburden material is perched above the quarry and can be readily moved into position (Fig. 6). Therefore, plans should ensure that ade-

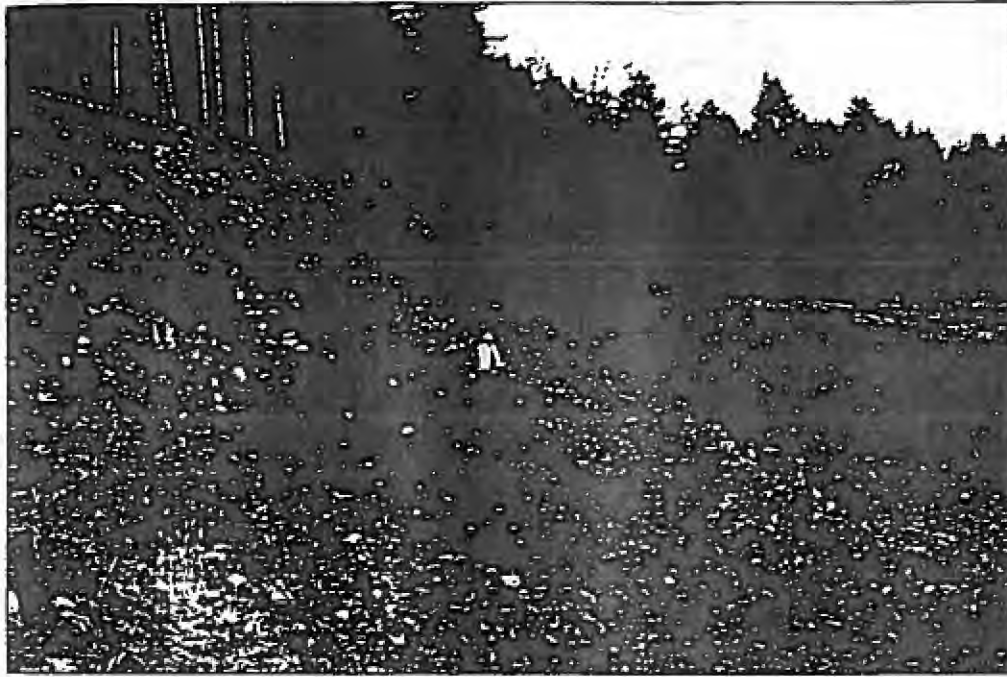


Figure 7. This slope was backfilled using material from the site. Additional material needed could not be taken from adjacent land because it was not part of the permit area. The expense of hauling in material made reclamation costs for this segment higher than the actual value of the rock mined. The belly scraper used to place material compacted the slope to make landsliding less likely. Alder trees, which are nitrogen-fixing plants that enhance soil fertility, will be used in revegetation to complete the reclamation of this segment.

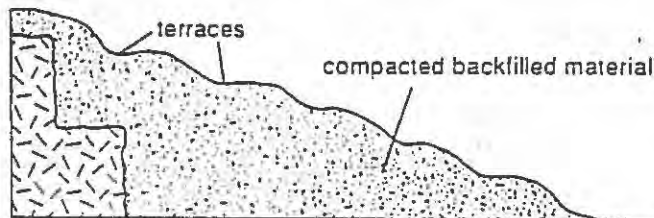


Figure 8. Quarry slopes that are backfilled should be compacted so that the final slope is stable; a 3H:1V slope (with terraces, if it is long) is generally a stable angle. Topsoil should be spread over the compacted slope to make revegetation possible.

quate amounts of material to accomplish reclamation are left in the setback area at the site. If a quarry has been mined to the permit boundary, however, backfilling may be the only way to accomplish reclamation. For a quarry located in a residential or populated area, backfilling is recommended only if no other alternatives exist for creating safe slopes (Fig. 7).

Regardless of the means of creating a slope, topsoil should be pushed onto the slope to promote revegetation.

Slopes

Stability is the first concern for slopes created by either blasting or backfilling during reclamation of the quarry. Once a material is blasted, it is no longer considered consolidated. If reclamation blasting is used to form a slope, a final angle of about 3H:1V is generally required for stability, topsoil application, and revegetation. If no revegetation is

necessary, such as on a scree slope of large boulders or where there is sufficient clay content in the backfill material for natural reseeding to be successful, then the slope may be as steep as 1.5H:1V.

Compaction of soil is necessary on many backfilled slopes to enhance stability and lessen the danger of saturating fill with water, which may cause it to liquify and fail. Temporary protection of the slope during the backfill operation may be necessary if backfilling occurs over a long period and planting of permanent vegetation must be delayed. Temporary methods that may be necessary to protect bare soils from rain or snowmelt runoff include seeding the slope with grasses or covering it with plastic sheeting, mulches, or matting.

Slopes backfilled for reclamation can be prone to erosion and gullying if they are smooth, flat, and long. As slope length and steepness increase, runoff velocity increases. This in turn increases the capability of water to detach and transport soil particles. With faster runoff, less infiltration and more erosion will occur. Careful location of drainage and water-control features will enhance slope stability and revegetation potential (Banks and others, 1981; Washington Department of Ecology, 1992).

Slopes longer than 75 feet should be shaped with rounded, natural-appearing terraces or benches to break the slope length and thereby reduce the velocity of water runoff (Fig. 8).

Pit Floors

For most subsequent uses, impermeable pit floors of solid rock should be blasted to fracture the rock (Fig. 4) so that water can drain slowly from the site. In addition, compacted ground and overburden on the floor should be ripped before placing topsoil to create seed beds for revegetation. Before deep ripping or tilling compacted mine wastes or soils, at least one backhoe pit should be dug on the site to determine how deep tilling must penetrate to reach below the compacted zone.

Rippers are mounted on heavy equipment and consist of a vertical shank or shanks that can crack or shatter compacted or hard areas to depths from 2 to 7 feet. Using rippers with longer-than-normal shanks and heavier points will decrease the need for equipment repairs and do a better job of ripping. A rule of thumb: ripper spacing should be less than or equal to the depth of ripping.

If topsoil is replaced using rubber wheeled equipment, ripping may be necessary to loosen this soil before planting either ground cover or trees. The drawback to ripping

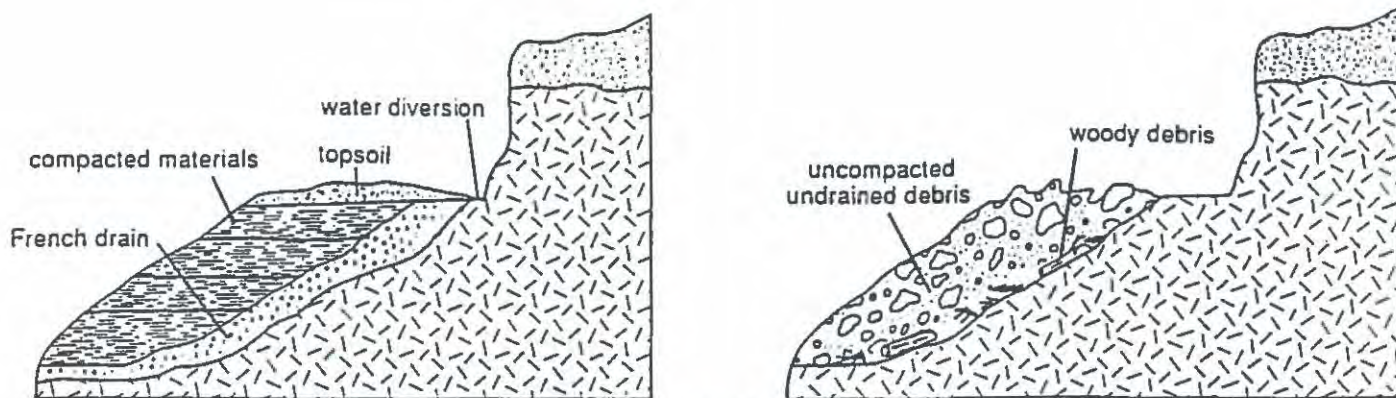


Figure 9. Before overburden waste is placed (left), vegetation should be cleared, and the drainage planned. French drains should be installed beneath the waste piles. Overburden should then be laid down in compacted layers. Water must be diverted away from the fill. Topsoil placed over the compacted fill will promote self-sustaining vegetation. Uncompact, improper fill (right) with no drainage that is placed over woody material can fail by landslides that may flow onto nearby lands and into water bodies.

slopes is that it can increase instability and erosion on slopes of 3H:1V or steeper. The quality of topsoil should not be degraded by mixing it with subsoils during the ripping process.

Mounds, hills, and boulder piles can be left on the quarry floor to vary the otherwise flat topography of the site. They should be covered with soil and seeded to control erosion and improve the appearance of the site, consistent with the subsequent land use.

Topsoil is placed on the surface as a last step before planting. In general, sloping the pit floor toward a highwall will prevent sheet runoff and retain soils and fine material on the site.

Overburden and Waste Piles

Many quarry operations have large amounts of overburden and create excessive amounts of waste rock. Some operators fail to make provision for storing this material in a stable area. Before the overburden is moved, vegetation should be cleared and drainage planned for the storage site. A properly compacted waste pile with drainage and water diversions is shown in Figure 9 (left). Topsoil should be placed over this compacted fill to promote self-sustaining vegetation. Undrained and uncompact fill (Fig. 9, right) dumped over vegetation and without drainage is prone to mass wasting and landslides.

Failure to remove overburden before mining will leave the overburden undercut and unstable. It may also result in landslides (Fig. 10).

REVEGETATION

Once the pit floor has been ripped and topsoil replaced on the floor and slopes, revegetation should begin as soon as possible during the next appropriate growing season. Well-planned planting or seeding can contribute to slope stability (Fig. 11). Topsoil replacement and revegetation should follow suggestions given in Norman and Lingley (1992).

For cliffs and highwalls that remain, rock-face texture will determine the potential for later plant growth. Broken and fissured rock faces that retain abundant fine material will eventually support plants. A solid rock face with nothing more than artificial ledges will have plants only on ledges that accumulate enough soil.

In general, most slopes of 3H:1V that have a soil cover can support self-sustaining vegetation. The choice of plants will be dictated by the slope material and climate. Selecting plants that do well on scree slopes or in coarse substrate helps assure successful revegetation.

Soils and fine sediments can be placed in pockets and holes at low spots on the quarry floor. These pockets retain moisture that will enhance the growth of trees planted there. Where coarse rock overlies rocky subsoil on slopes and floors and 2-year-old seedlings are to be planted, rocks should be arranged to make a hole that will hold approximately 5 gallons of high-quality soil. There must be a layer of appropriate subsoil at shallow depth into which roots can

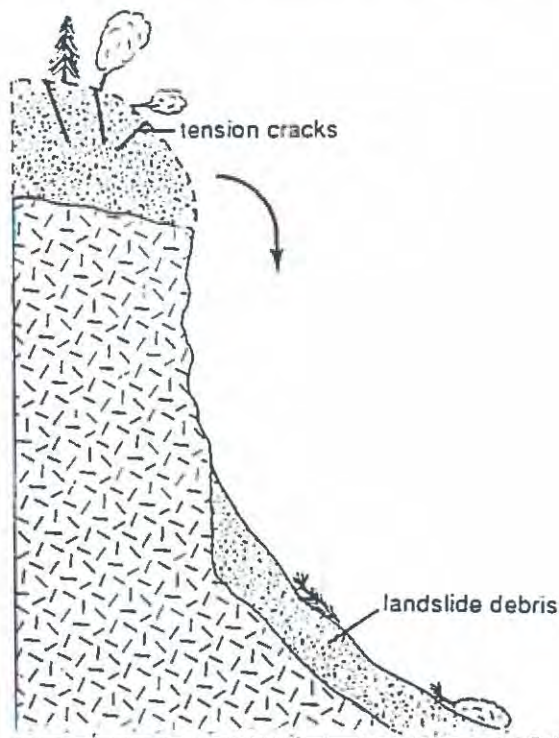


Figure 10. Mining without first removing overburden to a stable site can result in landslides that encroach on an adjacent landowner's property or nearby water resources.



Figure 11. An inspector evaluating the growth of 3-year-old Douglas fir and 4-year-old alder in a reclaimed segment of a quarry. Photo by M. A. Shawver.



Figure 12. Slopes in this eastern Washington basalt quarry were reduced by moving unused blasted rock and overburden from around the edges of the pit, which is approximately 150 feet by 400 feet. Revegetation has occurred only in areas where soil was present. Photo by Clint Bigger, Adams County Public Works Department.

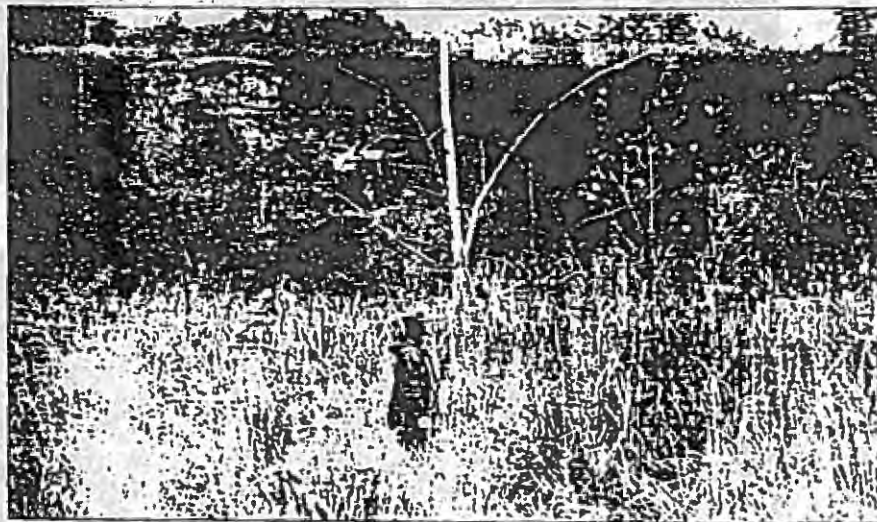


Figure 13. A wetland has formed on this reclaimed quarry floor. Wetland plant species include cattails and bulrushes; along the wetland margin are alder and cottonwood trees. The highway in the background is appropriate to this area because there were cliffs here before mining. Spurs and chutes have formed along the highway, creating a natural appearance.

grow. There should be no air pockets in the soil or materials below it.

Mounds of coarse material left on the pit floor or elsewhere in the quarry will drain quickly. Plants on such mounds will be susceptible to drought. Mature trees growing on mounds may topple in strong winds because of poorly developed root systems. Topsoil placement and choice of plants can avoid some of these problems.

It is more difficult to accomplish reclamation in eastern Washington because that part of the state has less precipitation, as well as lower nutrient availability, coarser grained soils, and higher and lower temperatures than western Washington. Wind erosion, a significant factor in eastern Washington, removes newly formed clay and silt from the soil. In general, conditions are harsher, and successful revegetation requires selection of proper plant species, appropriate timing of planting, adequate fertilization, and the presence of organic matter (Fig. 12).

WET QUARRIES

Quarried areas commonly include a seep or spring. These water sources can be included in the design and construction of a pond or wetland (Fig. 13). Many suggestions for reclamation of mined sites as wetlands and lakes discussed in Norman and Lingley (1992) can be applied to quarry reclamation. For example, quarries reclaimed as lakes (Fig. 14) will provide wildlife habitat. Islands for nesting sites can be made from rock processing waste. A variety of trees and shrubs should be provided for desired habitat diversity.

RCW 78.44 requires that there are places provided for people and animals to get out of deep water at a reclaimed site (RCW 78.44.090 (1b)). Scree slopes, benched steps, or gentle slopes along shorelines create shallow areas that offer easy escape from the water (Fig. 15).

SUMMARY

This article has discussed some ideas, techniques, and guidelines for reclaiming quarries. For a further discussion of reclamation strategies, critical elements of topsoil removal, storing, and replacing, and revegetation, see Norman and Lingley (1992).

REFERENCES CITED

- Amimoto, P. Y., 1978 (repr. 1981), Erosion and sediment control handbook: California Division of Mines and Geology. 197 p.
- Banks, P. T.; Nickel, R. B.; Blome, D. A., 1981, Reclamation and pollution control—Planning guide for small sand and gravel mines: U.S.

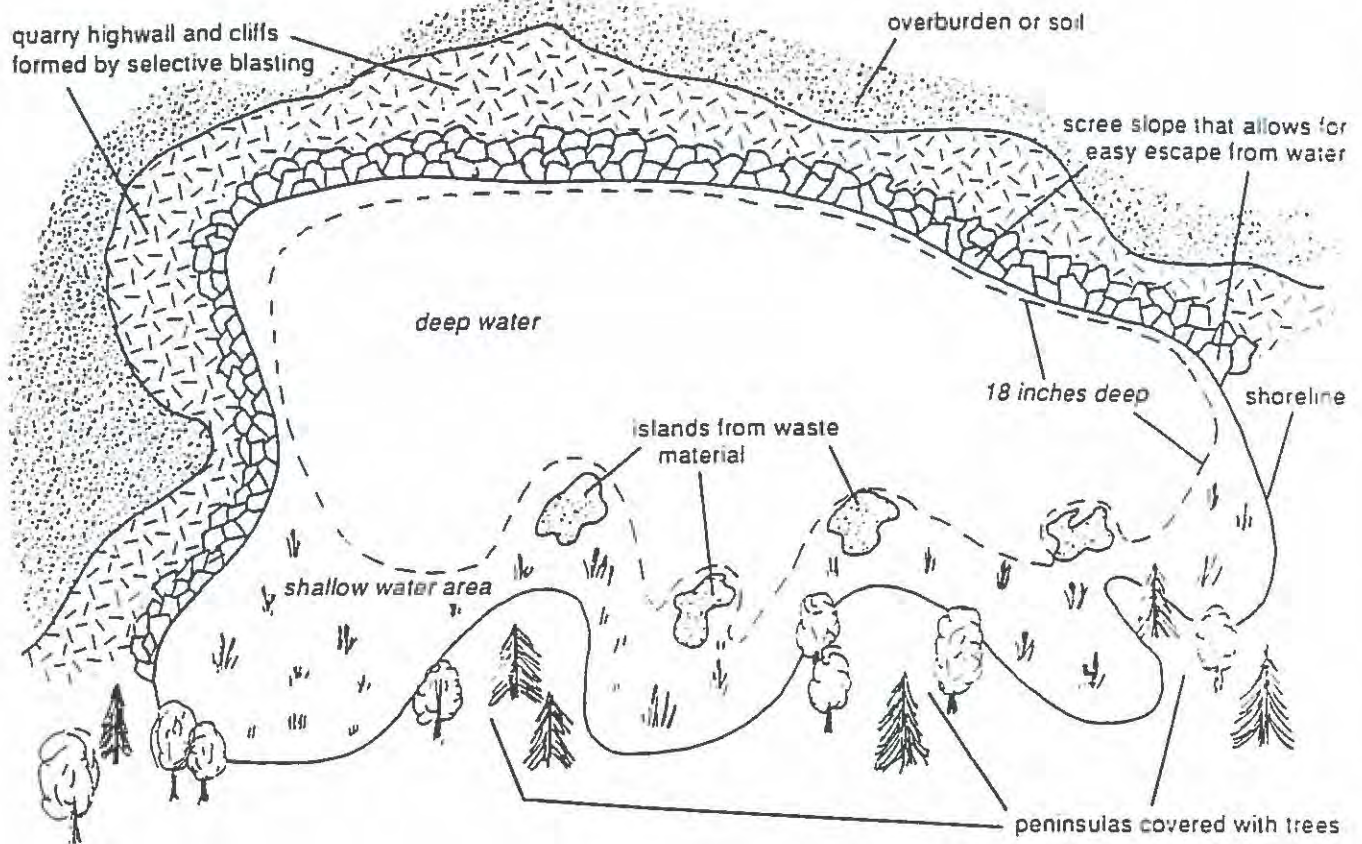


Figure 14. Sketch plan of a wet quarry after final reclamation showing shallow areas, island nesting sites, and a rounded natural appearance. Scree slopes and flat, shallow areas provide access or escape around the entire perimeter of the lake. No scale is implied.

Bureau of Mines Minerals Research Contract Report, 143 p.

Coppin, N. J.; Bradshaw, A. D., 1982, Quarry reclamation—The establishment of vegetation in quarries and open pit non-metal mines: Mining Journal Books (London, England), 112 p.

Foster, G. R., 1991, Advances in wind and water erosion prediction: *Journal of Soil and Water Conservation*, v. 46, no. 1, p. 27-29.

Goldman, S. J.; Jackson, Katharine; Bursztynsky, T. A., 1986, *Erosion and sediment control handbook*: McGraw-Hill Book Company, 1 v.

Gray, D. H.; Leiser, A. T., 1982, *Biotechnical slope protection and erosion control*: Van Nostrand Reinhold Company, 271 p.

Norman, D. K.; Lingley, W. S., Jr., 1992, Reclamation of sand and gravel mines: *Washington Geology*, v. 20, no. 3, p. 20-31.

Petrunyak, Jim, 1986, Blast casting reduces cost of removing quarry overburden: *Atlas Blasting News*, v. 12, no. 4, p.3.

Thorne, Vincent, 1991, Reclaiming Feldspar Quarry: *Atlas Blasting News*, v. 17, no. 1, p. 11.

U.S. Bureau of Land Management, 1992, *Solid minerals reclamation handbook*: U.S. Bureau of Land Management Manual Handbook H-3042-1, 1 v.

Washington Department of Ecology, 1992, *Stormwater management manual for the Puget Sound Basin*: Washington Department of Ecology Publication #90-73, 1 v. ■

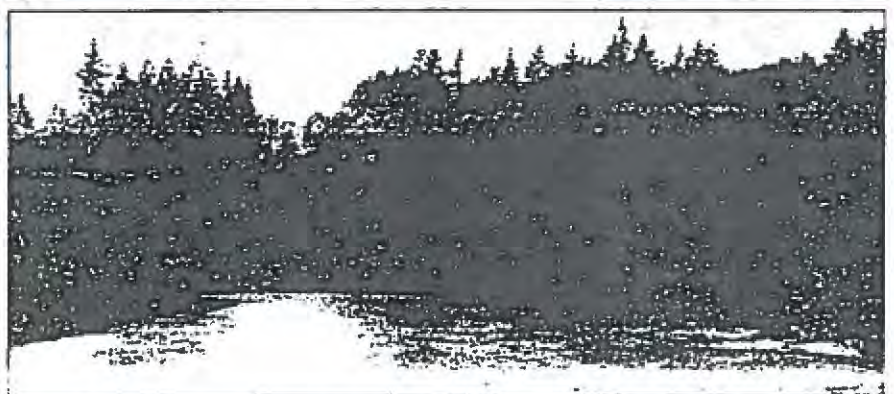
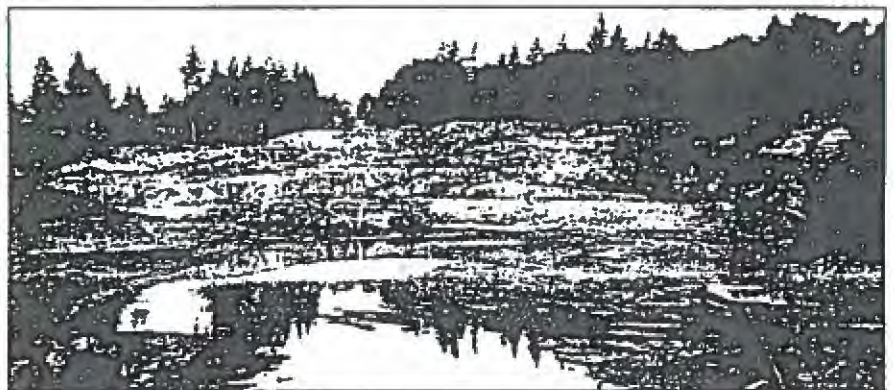


Figure 15. Top photo shows post-mining unreclaimed steep slopes. The bottom photo was taken a week later, after soil was pushed down to form slopes and flat areas for escape from the pond.

New Division Releases

Directory of Washington mining operations, 1992, Information Circular 87, by William S. Lingley, Jr., and Connie J. Manson. A 76-page report featuring indexes of Washington mining operations by operator, by county, and by commodity and a discussion of 1991 mineral production and mining activities, particularly sand and gravel, in Washington. \$2.30 + .20 (tax) = \$2.50.

Geologic map of southeastern Asotin County, Washington, Geologic Map 40, by Stephen P. Reidel, Peter R. Hooper, Gary D. Webster, and Victor E. Camp. This map comprises the Anatone, Weissenfels Ridge, Fields Spring, Black Butte, Captain John Rapids, and Limekiln Rapids 7½-minute quadrangles, plus a narrow strip at the north end of the Jim Creek Butte 7½-minute quadrangle in Washington. Includes a table of major element analyses of basalts from southeastern Asotin County. The text accompanies one oversize 1:48,000-scale geologic map, a cross section, and a correlation chart. 22 pages, 1 plate. \$.93 + .07 (tax) = \$1.00.

Call for Papers

Canadian Dam Safety Association
5th Annual Conference
St. John's, Newfoundland, Canada
September 19-23, 1993

Authors are invited to submit abstracts (up to 1,000 words) of papers relating to the theme of the conference, which is dam safety practices and procedures. Papers on such topics as regulation and legislation; standards, guidelines, and criteria; dam safety review; O & M; technical issues; and case histories are welcome. New ideas and concepts are especially encouraged. Deadline for abstracts: January 31, 1993. Contact: R. D. Barnes; Newfoundland and Labrador Hydro; P.O. Box 12400; St. John's, Newfoundland, A1B 4K7, Canada.
Tel: 709/737-1266; Fax: 709/737-1972.

Division Items Now Out of Print

Bulletin 50, Geology and mineral deposits of the north half of the Van Zandt quadrangle, Whatcom County, Washington; Bulletin 54, Geology and mineral resources of the Kelso-Cathlamet area, Cowlitz and Wahkiakum Counties, Washington; and Set 1, Mount St. Helens slides, are now out of print and no longer available for purchase.

Reprints Available

A limited number of reprints of *Seismicity of Washington and Oregon*, by R. S. Ludwin, C. S. Weaver, and R. S. Crosson, have been donated by the senior author for distribution to our readers. The report appeared in Slemmons, D. B.; Engdahl, E. R.; Zoback, M. D.; Blackwell, D. D., editors, 1991, *Neotectonics of North America: Geological Society of America DNAG Decade Map Volume 1*, p. 77-98. Free upon request, but please add \$1.00 for postage and handling.

Please add \$1.00 to each order for postage and handling.

Our mailing address is on p. 2 of this publication.

In order to serve you as promptly as possible, we would appreciate having your Zip Code and the four-digit extension for your address with your correspondence.

Clarification of USGS Spokane Addresses

The USGS Geologic and National Mapping Divisions have moved to:

W. 904 Riverside Ave., Rm. 117
Spokane, WA 99201

The Water Resources Division remains at:

694 U.S. Courthouse
W. 920 Riverside Ave.
Spokane, WA 99201



WASHINGTON STATE DEPARTMENT OF
Natural Resources

Division of Geology and Earth Resources
P.O. Box 47007
Olympia, WA 98504-7007

BULK RATE
U.S. POSTAGE PAID
Washington State
Department of Printing

Reclamation of Sand and Gravel Mines

by David K. Norman and William S. Lingley, Jr.

INTRODUCTION

The Surface Mining Act (Chapter 78.44 RCW) sets forth minimum allowable standards for mine reclamation in Washington. However, miners are often at a loss for guidance when it comes to restoration. There is little published information and even less scientific research on methods of achieving effective gravel-pit reclamation. This article is intended to introduce sand and gravel miners to various reclamation options.

Reclamation objectives are similar for most gravel mines. Short-term goals are maintaining air and water quality and reducing aesthetic impacts during mining; these can be accomplished chiefly by minimizing the disturbed area. The main long-term objectives are to return gravel pits to a stable, usable condition and to produce an area that blends with its surroundings.

These objectives are accomplished by sculpting the mined surface and establishing a pioneer vegetative community that will ultimately produce a new multi-layer soil and a self-sustaining ecosystem. This objective can be realized if the miner adopts a stewardship approach, like that of a farmer planting crops for harvest. There are many ways to accomplish these goals, and each site presents opportunities for creative responses to the regulations. And there are many good examples of reclamation in Washington mines.

RECLAMATION STRATEGIES

RCW 78.44.080 identifies subsequent use as a criterion for guiding the reclamation scheme. For example, restoring sinusoidal, natural-appearing topography is necessary for mines in scenic areas. When planning mines in deposits that overlie aquifers, the subsequent use cannot preclude restoration of dense vegetation or impermeable top seals that will protect the aquifer. Reclamation literature, however, makes numerous references to subsequent uses that are uncommon in a competitive market, such as golf courses.

Three strategies are generally used in surface-mine reclamation:

- (1) Progressive or continuous reclamation, in which minerals are removed and overburden is immediately replaced; this is the method used in strip mining minerals such as coal
- (2) Reclamation after all resources have been depleted from the entire mine
- (3) Segmental reclamation, or reclamation following depletion of minerals in a sector of the mine.

The legislature recognized segmental reclamation as the strategy of choice for most Washington sand and gravel mines and adopted it in 1970 as part of the Surface Mining Act.

Sand and gravel miners rightly point out that progressively reclaiming land that overlies known mineral resources can be wasteful. Progressive reclamation is perceived by the public as the preferred technique. However, soils that overlie most sand and gravel deposits are thin and render this technique impracticable or impossible for those operations that must blend different sand and gravel sizes from various parts

of the mine site in order to achieve product specifications. Untimely interim reclamation results in: (1) disturbing more land per unit of mineral produced and (2) diminished final reclamation quality because more soil is moved more often. On the other hand, postponing reclamation until all resources are depleted does nothing to mitigate short-term environmental impacts on air and water and nuisances to neighboring residences.

Advantages of segmental reclamation over reclamation after completion of all operations are: (1) it generally costs less because less material is moved and (2) it establishes final slope angles and shapes in the process of excavation rather than as a separate operation. Segmental reclamation uses equipment while it is on site. It also reduces loss of clay and silt, which are critical for retaining moisture and nutrients essential for vegetation. Segmental reclamation enhances the potential for establishing a self-sustaining soil/plant ecosystem. Restoration of chemical, physical, and biological processes is less expensive when reclamation is started as soon as possible and spread over the life of the mine.

Segmental reclamation works best in homogenous deposits where mining proceeds in increments. A typical segment might comprise 600 linear feet of working face and 6 acres. Segments will be larger in heterogeneous deposits (for example, fluvial deposits), where blending minerals from many places in the mine is required. Prior to mining, topsoil in the first segment is strategically stockpiled to minimize handling. When the sand and gravel have been removed from the first segment and the slopes have been reshaped according to the reclamation plan, topsoil from the first and second segments is spread on the first segment's surface. Prompt planting with grasses, legumes, and nitrogen-fixing trees will quickly produce a cover that reduces erosion, retains moisture, and reduces the heat on the slope surface. Revegetation of the floor of the first segment does not occur until the area is no longer needed for mineral processing or maneuvering trucks. Immediately prior to planting, the pit floor is plowed or ripped because most plants cannot grow in soils that have been over-compacted by heavy machinery.

RECLAMATION PLANS

An operating and reclamation plan can be thought of as both a financial planning document and a contract that defines the topography and vegetation of the site after reclamation is complete. This plan describes the strategy to achieve acceptable reclamation at the lowest possible cost by establishing an economic limit of gravel production for each site. It also identifies and addresses mitigation of potential environmental impacts, such as gullying of impermeable clays or sands, for which the operator is liable; establishes a segmental sequence of mining and reclamation that will avoid unnecessary earth moving; and identifies appropriate equipment.

A good operating and reclamation plan should be simple, practical, and easy to implement. The plan should be flexible and take into account the potential for unanticipated changes in the geology and market that will affect reclamation. The plan should make provisions for quality reclamation even if

mining to depletion never occurs. Managers and senior equipment operators must be familiar with the reclamation obligations to which the permit holder has committed.

A typical plan might include:

- A description of the ground-water hydrology and details of how the site will be mined (that is, wet or dry)
- Existing topography
- Subsequent use of the land, appropriate for the location of the mine
- Sequence of topsoil stripping, storing, and replacement on mined segments
- Designation of overburden storage areas beyond the limit of mining but positioned for the shortest possible downhill transport during reclamation
- Direction and sequence of excavation that will result in reclamation as soon as possible after completing mining on any segment and within the constraints of economically efficient mining
- Location of waste rock piles and how they will be reclaimed and stabilized
- Final grades and shapes of the pit walls and floor to incorporate sinuous contours and effective drainage
- Permanent drainage and water-control systems
- Schedule of planting to assure plant survival
- Specifications for ground-cover plants to minimize erosion and establish conditions that will increase the survival rates of trees
- Tree-planting specifications and schedules to make use of conditions established by a healthy ground cover.
- Locations of trees to stabilize the site and generate a new humic layer
- Other information pertaining to the permit and required by statute.

Figure 1 shows maps and cross sections from a typical operating and reclamation plan for a sand and gravel mine. The mine will be excavated initially as a dry site, but mining to greater depths will eventually penetrate the water table and result in a permanent lake and associated wetlands. The operational portion of the plan is used to identify excavation areas, processing facilities, roads, utilities, stockpiles, water-control systems, visual screens, berms, and areas to be left undisturbed. Maps and cross sections display information such as slope angle and shape, revegetation plans, and final drainage. In Figure 1a, special attention has been given to moving topsoil and overburden. Narrative explanations (not included in Fig. 1) normally accompany the maps and cross sections to provide additional details of the operating and reclamation plan.

GENERAL GUIDELINES

Sand and gravel pits in western Washington are fairly easy to reclaim because the moist climate increases production of the clay component in soil and provides abundant precipitation for pioneer plants. Mined areas in eastern Washington are more difficult to reclaim because that region is drier and temperatures are more extreme. In addition, many soils contain fewer nutrients and are coarser. Wind in eastern Washington readily removes clay and silt from exposed soil. Therefore successful revegetation in the eastern part of the state is more dependent on proper plant selection, appropriate timing of planting, adequate fertilization, presence of organic matter, and, commonly, irrigation.

SITE PREPARATION

Removal of Vegetation

In a well-planned operation, vegetation is removed sequentially from areas to be mined. Vegetation is preserved where necessary to screen the site and to limit turbid water discharge from areas that will be disturbed.

Vegetation that is tilled into the replaced soil can increase humus. Woody material can be chipped and used as mulch or to add organic matter to the soil. Some of the trees and shrubs that have been cleared prior to mining can be set below the water table to form artificial "reefs" to provide habitat in new lakes or wetlands or placed in brush piles above ground to provide cover for wildlife.

Burying woody debris is allowed only if permitted by the county health district. In general, burial of any compressible material, even if allowed by the health district, should only be done in areas that will not be used for construction. As the debris rots, the pile compacts, and buildings placed on these piles may be damaged as the ground settles.

Bushes and small trees, together with some surrounding soil, can be scooped up and then transplanted to mined-out segments by using backhoes or front-end loaders. This technique is a cost-effective means of establishing a natural appearance in reclaimed segments, introducing seed trees, and providing screening from neighbors. These plants are already adapted to the area. Moving both soil and plant protects minute rootlets and micro-organisms that are important to plant propagation. Additionally, this soil may contain seeds or shoots of other vegetation; this facilitates spreading the flora across nearby areas.

Removing, Storing, and Replacing Topsoil and Subsoils

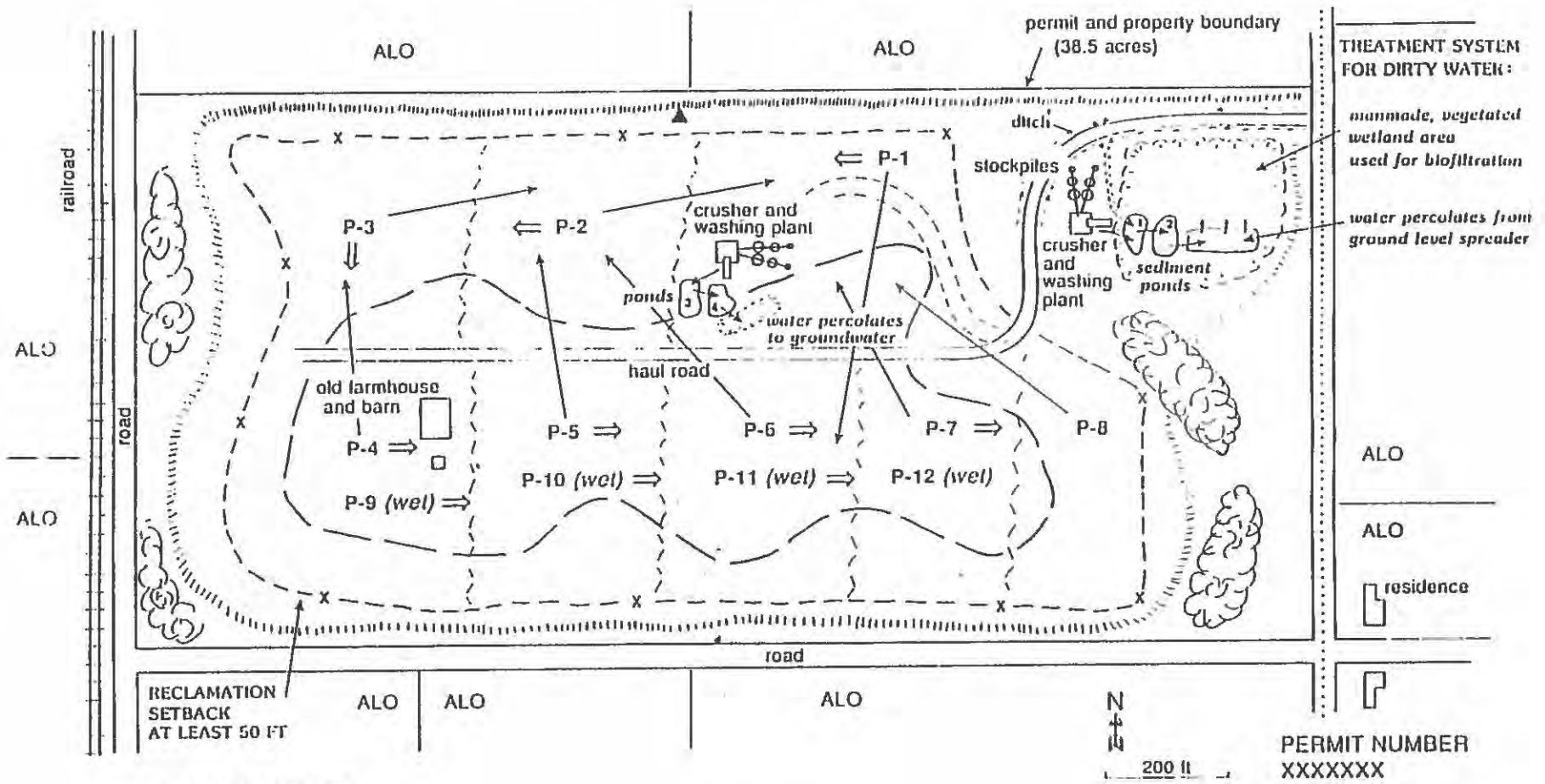
Topsoil can be identified by its dark color and humic content. It also has high water-retention capacity. Subsoils commonly contain fewer nutrients, but abundant clay in subsoils can adsorb moisture and nutrients. Furthermore, subsoils may act as a top seal that protects underlying aquifers.

Because topsoil is essential to successful reclamation, it should not be sold as a by-product of sand and gravel mining unless specific authority has been granted in the permit documents. Where there is insufficient topsoil for reclamation, clay-rich subsoils can be combined with wood waste to manufacture a topsoil substitute.

As mining proceeds, topsoil, subsoil, and other overburden not used immediately in reclamation should be stripped and stockpiled separately and revegetated to avoid erosion. Loss of fungi, rootlets, and micro-organisms in topsoil results from both moving and storing topsoil. Topsoil stored longer than 5 years is severely degraded. Soil structure is damaged if the soil is moved when too wet, and soil porosity is reduced by compaction. It is best to plan to move the soil only once, which also keeps operating costs low.

Topsoil should be replaced on slopes as soon as possible after restoration of topography. The less equipment moving over soils, the better: use of heavy earth-moving equipment, rubber-wheeled vehicles, and narrow tracks should be avoided during re-application so that soils are not compacted.

A common problem in re-applying topsoil and subsoil is spreading them too thickly initially so that little is left for remaining areas. A combination of not less than 8 inches of topsoil and 3 feet of subsoil is optimal. If topsoil is not

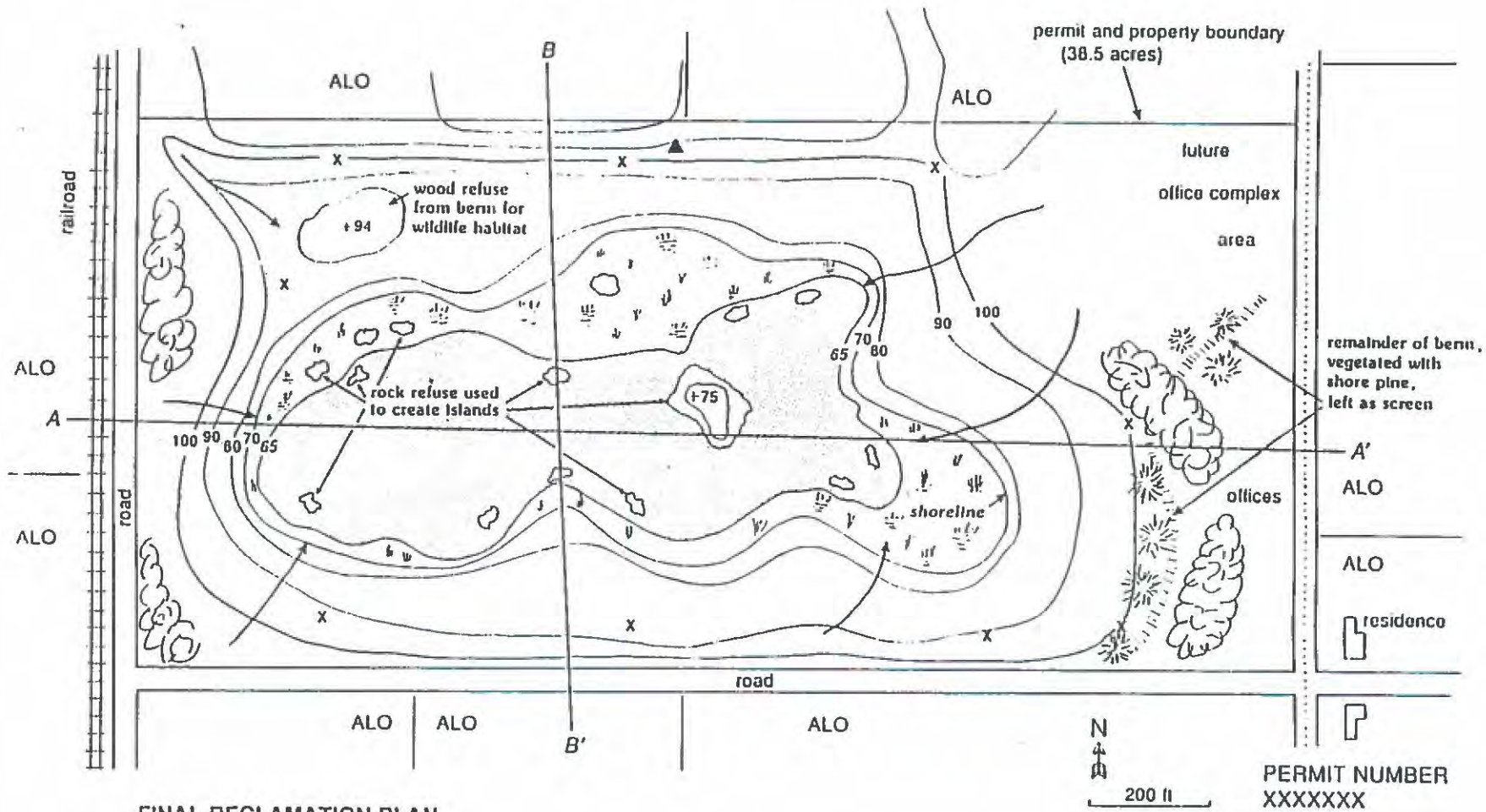


PHASES OF MINING

EXPLANATION

- - - - - edge of excavation
- · - · - edge of water in excavation
- ||||| berm - 20 ft high - planted with grasses, legumes, and shore pine to screen operation (berm removed only after mining is complete on entire project)
- ▲ permanent concrete monument for reference point
- original screening trees preserved
- gas pipeline
- ALO adjacent landowner
- ← indicates direction of topsoil and overburden stripping and replacement for reclamation
- P-3 ⇒ indicates phase and direction of mining
- x stakes at excavation limit (steel pipe 1.5 in. diameter, 4 ft above grade)

Figure 1a. Map for an operating and reclamation plan that shows the sequence of segments to be mined (counterclockwise from the northeast in this instance), as well as details of soil placement, screening, and drainage. This site is mined first as a dry site, but as mining proceeds into the southern segments, the water table is penetrated. The site will accommodate a small office complex and wildlife habitat when it has been reclaimed.



FINAL RECLAMATION PLAN

EXPLANATION

- X stakes at excavation limit (steel pipe 1.5 in. diameter, 4 ft above grade)
- gas pipeline
- ALO adjacent landowner
- ▲ permanent concrete monument for reference point
- (circle with tree) original upland trees preserved
- 80 final contours
- runoff from reclaimed area flows into lake
- shallow areas replanted with wetland species water

Figure 1b. Contour map of the site shown in Figure 1a as it will appear after reclamation. Cross sections A-A' and B-B' are shown in Figure 1c.

CROSS SECTIONS OF FINAL RECLAMATION PLAN

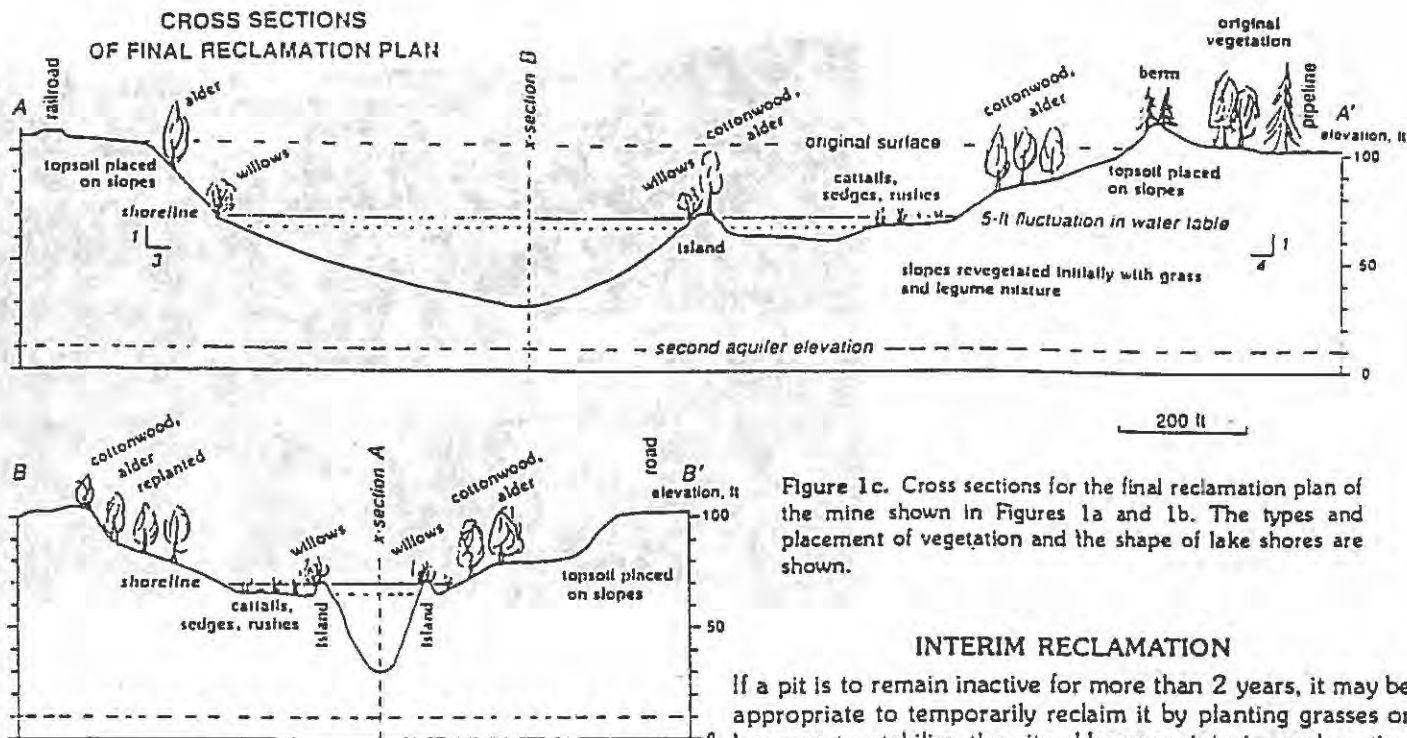


Figure 1c. Cross sections for the final reclamation plan of the mine shown in Figures 1a and 1b. The types and placement of vegetation and the shape of lake shores are shown.

plentiful, its application should be restricted to low areas or excavated depressions that will conserve soil, retain moisture, and catch wind-blown pioneer seeds. These are also ideal sites for planting trees.

BUFFERS, SETBACKS, AND SCREENS

Buffer zones and reclamation setbacks are necessary at many mines because they provide visual, noise, and discharge screening. Although generally less effective than buffer zones, which rely on distance for their effectiveness, narrower buffers for screening can be created with vegetation, walls, fences, or berms.

Natural buffer areas should remain undisturbed during the life of the mine. Keeping equipment and stockpiled materials out of buffer areas will help to preserve them; flagging, fences, or monuments will alert operators to areas to be avoided in mining or reclamation. If vegetation is present on slopes that might be unstable if bare, those plants should be protected. Activity near trees and shrubs should be kept outside the area below the longest branches (or drip line).

If the cut-and-fill method is to be used to restore slopes, a setback from the property boundary that will assure sufficient material for reclamation is almost always necessary. For example, on a vertical mined face, if a 3 feet horizontal to 1 foot vertical (3H:1V, 33%, or 18 degree) final slope is required, a setback 1.5 times the depth of excavation will be necessary to provide material—that is, a 40-foot-high slope will require a 60-foot setback to provide the necessary volume of material to create the desired slope when mining is completed. On gentler slopes, less material will need to be moved to achieve the reclaimed slope.

Setbacks from streams are essential and should be at least 200 feet wide. No part of that width should be on the 100-year floodplain unless a shoreline permit has been issued.

INTERIM RECLAMATION

If a pit is to remain inactive for more than 2 years, it may be appropriate to temporarily reclaim it by planting grasses or legumes to stabilize the site. However, interim reclamation that involves earthmoving should not be performed where topsoil necessary for final reclamation is in short supply. About 15 percent of this soil is lost each time it is moved. Blocking roads and building fences can help protect inactive mines by reducing access and unauthorized activities such as garbage dumping and off-road recreation.

SHAPING THE RECLAIMED PIT

A key element in restoring topography is creating slopes that blend with the surrounding landforms. The goal is to establish rough slopes that are curved in plan and section (Fig. 2). Rectilinear slopes are inappropriate for reclamation because they are prone to sheet erosion and gully erosion and because they look unnatural. Sinuous slopes can be formed either by mining to the prescribed angles or by using the cut-and-fill method. New drainages should be established, and contours must tie smoothly with contiguous offsite topography.

Rough, rounded topography cannot be achieved without bringing bulldozer operators into the final reclamation planning process because uninformed operators normally create the traditional straight-planar topography (by "grading").

The terrain at a reclaimed site should consist entirely of stable slopes. A rule of thumb is that slopes are unstable if pioneer plants cannot establish themselves naturally or if the slopes ravel. In general, sand and gravel are stable and can sustain vegetation at slopes of 3H:1V. To vary the topography, a few locally steeper areas (1.5H:1V) may be created. However, these areas will be difficult to revegetate and will be unstable unless the substrate has a high enough clay content to retain moisture or is covered with topsoil.

Bare or steep slopes greatly increase the potential for erosion. Long steep slopes produce more and faster runoff and allow less infiltration than short, gentle slopes.

Some guidelines for slope reclamation are:

- Steep slopes (such as 3H:1V) should be kept shorter than 75 feet by curved terracing and berming.

- Tracked equipment should be run up and down a slope, rather than across, to increase slope roughness, which in turn will intercept more runoff and reduce its velocity, trap seeds, and speed revegetation. (Older bulldozers are generally unable to back up sand and gravel slopes steeper than 3H:1V.)
- Reclaimed working faces should be revegetated immediately following creation of the slope to minimize erosion.
- If the site is to be dry after mining, then pit floors should be graded to a slope of 2 to 5 percent to promote drainage.
- Mounds and hills can be left on the flatter areas of pit floors to vary the topography.

Surface-water Drainage

Planning drainage for the site is critical. During operations, water should be passed through vegetated areas or sediment retention systems to slow runoff and filter or settle muddy water. Following mining, dry retention ponds are good sources of clay for other parts of the mine. Clay slurries from these ponds have been pumped onto barren gravel slopes at the Steilacoom mine to provide a clay-rich substrate for plants.

During mining, water should be diverted around slopes to prevent both erosion and mixing turbid with clear water. Diverted water should tie into the natural drainage. Dikes, ditches, or a combination of these structures divert runoff from the working face. For short slopes, placing a diversion at the slope top works well. For longer slopes, diversions can be placed at intervals to effectively reduce slope length.

Manmade drainages should be sinuous, have a low gradient, and be protected by riprap or vegetation or both. They should be designed to control the 100-year 24-hour precipitation event indicated on the maps in Miller and others (1973). If ponds are to be left, then drainage can be directed to the ponds. Outlets from ponds must be identified and carefully protected from erosion, which could cause catastrophic breaching of the pond. Guidelines for shaping reclaimed sites that extend below the water table are presented under "Subsequent Land Uses".

Approval from the Department of Fisheries or the Department of Wildlife is required prior to diverting streams. See Norman (1992) for a discussion of the jurisdictions and responsibilities of other agencies.

REVEGETATION OF THE SITE

In the past, many operators relied solely on natural revegetation. However, aggressive revegetation quickly improves the appearance of a site, stabilizes the soil, reduces erosion, and eliminates turbid offsite water discharge. It can also result in reduction of the State security bond for reclamation. Revegetation early in the reclamation process ensures that plants are thriving when the mine is closed.



Figure 2. Moving earth and shaping the mined surface are important steps in reclamation. Shown is the Central Pre-Mix Yardley pit, where the central part of the pit is being shaped with gentle contours, canals, and islands. Subsequent uses of this pit are a heavy industrial area (concrete products) and a lake and wetland area for wildlife. (Photo by Mark Murphy, Central Pre-Mix)

Mined sites generally present harsh conditions that hamper re-establishing vegetation. Nevertheless, much can be done in the planning stages to increase the chances for successful seeding and planting. Selection of the right seeds and plants for the site, good seedbed preparation, timing of planting, and conscientious maintenance are important.

A useful publication for selecting plants is *The Washington Interagency Guide for Conservation and Forage Plantings* (Washington State University Cooperative Extension, 1983; available at minimal cost). Local nurseries may be able to provide appropriate plants and seeds. A directory of Pacific Northwest native plant suppliers can be obtained from Hortus Northwest (503/266-7968) in Canby, OR, the Department of Natural Resources, or the local phone book. (See also Shank, 1990.) The Soil Conservation Service and county extension agents may also be sources of information.

Revegetation with grass and legumes should occur during the first appropriate season after slope shaping and replacement of topsoil. In this way, erosion by wind and water is minimized and the possibility of landslides or other slope failures is diminished. However, vegetation cannot be expected to control erosion or prevent soil slippage on unstable slopes. The 1.5H:1V slopes allowed under the surface mining statute (RCW 78.44.090) have failed by landslide even where covered by dense growths of Scotch broom.

Earthwork, usually completed during the summer, should be followed by aggressive revegetation in the fall. First plantings should be ground cover consisting of a mixture of grasses and legumes that are quick to establish. Successful revegetation is often dependent on the weather. Spring revegetation is usually successful only if the spring and summer are cool and wet. Fall revegetation is normally successful if the soil is wet and warm. Ground cover should be supplemented with pioneer trees and shrubs. Late winter is often the best time to

plant shrubs and trees. Miners should be prepared to irrigate young plants; however, long-term irrigation is neither cost effective nor ecologically sound.

Whenever possible, native species should be used for replanting. These plants are adapted to local conditions, and survival rates are high. Native species are less likely to require irrigation, which is a large maintenance burden. Scotch broom and gorse are widespread pioneer plants that fix nitrogen, but these are not native and are considered undesirable noxious weeds. If they are already established at a mine site, it is appropriate to leave them until the site is stabilized. (Unfortunately, many weeds currently targeted by weed control agencies are superior for reclamation purposes.) Clearing small areas and planting trees, if conditions permit, begins the process of eliminating Scotch broom or gorse while maintaining site stability and minimizing erosion.

A trial-and-error approach to revegetation relying on natural precipitation and hardier natural pioneer species (such as alder) is generally less expensive, uses less labor, and is more effective than waiting until mining is complete to plant the entire site with commercial plants. Segmental mining results in fairly small areas on which to begin this process. Test plots can be used to determine which species will be successful. Areas in which plants fail to establish can be reseeded with more appropriate vegetation.

It is tempting, particularly with trees, to plant only climax species (for example, Douglas fir) even if the ground is not fully prepared. However, natural communities develop slowly through a succession from pioneer species to climax, each phase preparing the ground for the next. Mimicking this progression during reclamation is impractical, but planning a phased succession for both ground cover and trees will establish a good climax mix.

Grassland development can start with either a quick pioneer soil builder under a developing woodland or a climax flora for grazing. Similarly, many pioneer trees will act as a quick-growing nursery for evergreens and other trees that mature slowly and do not grow well in fresh ground or open areas. Nitrogen-fixing species (herbaceous legumes such as clover and lupine, and trees such as black locust, Russian olive, and alder) play a crucial role in the soil building and development stages (Fig. 3). (See Table 1).

Generally, establishing widespread healthy vegetation takes several seasons. Follow-up evaluations may be necessary to monitor progress and to determine why plants did not thrive. If vegetation is evenly but sparsely distributed over the entire area, minimal reseeding and fertilization is needed. However, if vegetative cover is inadequate to prevent rill erosion, the eroded areas should be regraded, reseeded, and fertilized in accordance with the soil test results. If large areas



Figure 3. Nitrogen-fixing species such as red alder, clover, and Scotch broom are useful in reclamation because soils in many mined areas are deficient in nitrogen. [Scotch broom should gradually be eliminated from the site.] Initial attempts to revegetate this area with grasses and Douglas fir were unsuccessful. A stand of red alder just beyond the area of this photo was left to act as a seed source for the young trees, shown here with mine operator Milt Emerick. The nitrogen added to the soil by these plants improves the soil for later plantings.

remain bare after 1 year, the choice of plants and fertilizer should be re-evaluated and the process restarted.

Tree and Shrub Planting

In addition to their slope stability, sediment control, and visual screening values, trees and shrubs reduce the rectilinear appearance of most sand and gravel mines. They also provide natural beauty and wildlife benefits; for these uses they are more effective when planted in clumps or groups. Suitable species are listed in Table 1.

Some guidelines to help assure successful planting are:

- Trees and shrubs do best if planted in topsoil.
- If no topsoil is available, trees or shrubs can be established in subsoil amended with generous amounts of organic matter.
- When planting trees and shrubs, make sure roots are not twisted, exposed, or placed on boulders and that there are no large air pockets in the soil.
- Mulches of straw, leaves, grasses, or wood chips should be piled around the base of trees and shrubs.
- Competing vegetation, if significant, should be removed from the area where trees or shrubs are to be placed.
- High-quality stock should be used. Normally, 1- or 2-year-old deciduous seedlings and 3- or 4-year-old conifer transplants are adequate.
- Planting should be done while trees and shrubs are dormant, generally from early November to late March.
- Stock should be properly handled, including being kept cool and moist and planted as soon as possible.

A cost-efficient method of establishing trees is to plant willow, poplar, evergreen, or alder shoots that can be taken from ditches along many roads. Branches cut from willows will take root in wet sites, especially if the ends of the cuttings are coated with rooting hormones.

Table 1. Some recommended trees for reclamation in western and eastern Washington (adapted from Coppin and Bradshaw, 1982); P, pioneer species; Cl, climax species; N, fixes nitrogen; D, dry sites; M, moist sites; W, wet sites; Fl, tolerates flooding

Western Washington			Eastern Washington		
Species	Role	Soil conditions	Species	Role	Soil conditions
Red alder	P,N	D,M,W	Russian olive	P,N	D
Shore pine	P,Cl	D,Fl	Black Locust	P,N	D,M
Ponderosa pine	P,Cl	D	Poplar	P	W,Fl
Douglas fir	P,Cl	D,M	Lodgepole pine	P,Cl	D,Fl
Poplar	P	W,Fl	Ponderosa pine	P,Cl	D
Big leaf Maple	P,C	M	Juniper	P,Cl	D
Willow (shrub)	P	M,W,Fl	Serviceberry (shrub)	P	W,M
Tree lupine (shrub)	P,N	M,W	Sagebrush	P	D
			Bitter brush	P	D
			Willow (shrub)	P	M,W,Fl
			Tree lupine (shrub)	P,N	M,W

Western Washington

Fertilizer is usually necessary to re-establish vegetation for parts or all of some mined sites and can be tailored to each site's characteristics and soil. Amounts and composition can be determined through a soil analysis, which can be done by the County Extension or local soil testing labs. Fertilizer should be worked into the top 4 inches of soil. Time-release fertilizer is best; otherwise, re-fertilization may be necessary. Adding organic amendments (such as manure) may require permission from health authorities. Less nitrogen will be required if nitrogen-fixing species are planted. Normally, a balanced fertilizer (16-16-16 or 10-20-20) should be used, but fertilizers can be designed to more effectively correct specific soil deficiencies.

For upland sites in western Washington, good soils can be established with the following amendment application rates:

Nitrogen	50 lb per acre
Phosphoric acid	50 lb per acre
Potassium	50 lb per acre
Lime (for acid soils (pH<7))	-1,700 lb per acre

Grass and legume seeding requirements also vary from site to site, depending on slope orientation, soil type, and precipitation, among other factors. Planting should be done between April 1 and June 30 and from September 15 through October 31. If planting is done in July and August, irrigation will be required. Plantings between November 1 and March 31 need immediate mulching to provide a protective cover from the weather.

Table 2. General seed mixes and rates of application per acre for western Washington; these mixes should be adjusted to meet specific needs

For dry upland sites:		For wetlands or wet sites:	
Sicklekeel lupine (N-fix)	30 lb	Red top	20 lb
Creeping red fescue	30 lb	Birdsfoot trefoil	20 lb
Perennial rye	15 lb	Creeping red fescue	20 lb
Orchard grass	25 lb	Total	60 lb
Colonial bent grass	5 lb		
White clover	5 lb		
Cereal rye	5 lb		
Total	115 lb		

Seed mixes offer better chances of successful revegetation because a variety of species is included. Some successful mixes and application rate per acre are given in Table 2.

It is not critical to have the exact seed mix listed in Table 2 as long as the components are present. Many seed stores have prepared mixes that approximate those in Table 2 and may be cheaper than custom mixes. Seed mixes and fertilizer cost about \$100 to \$125 per acre, but price will vary with quantity of seed and fertilizer. Using nitrogen-fixing species will assure that the site becomes self-sustaining sooner and will require fewer fertilizer treatments.

Seeds should be covered with topsoil or mulch no deeper than a half inch. Regardless of how burial is accomplished, seed should be covered to assure germination and survival.

Wetland Seed Mixtures and Plants

Establishing functional self-sustaining marshes, lakes, or bogs can take years, but they contribute significantly to an area's ecological health. Consulting a biologist with expertise in wetlands will aid significantly in creating successful new wetlands. As a general guide, apply the wetland seed mixture in Table 2 at a rate of 60 lb/acre and, in addition, plant tubers for cattail, bulrush, and slough sedge, and willow cuttings. Invasive plants such as reed canarygrass or purple loosestrife should not be used (Washington Department of Ecology, 1991). Water should be no deeper than 3 feet and in much of the site should be less than 18 inches deep. (See Wetlands and Lakes below). Nitrate fertilizers should not be used.

Eastern Washington

All the basic principles for planting and fertilization discussed above apply to eastern Washington. In this part of the state, planting so that vegetation covers every square foot of ground is impractical. The climate and, in some places, lack of topsoil mean that special care is needed to establish vegetation on mined sites. Segmental reclamation offers an opportunity to test various mixes and amendments.

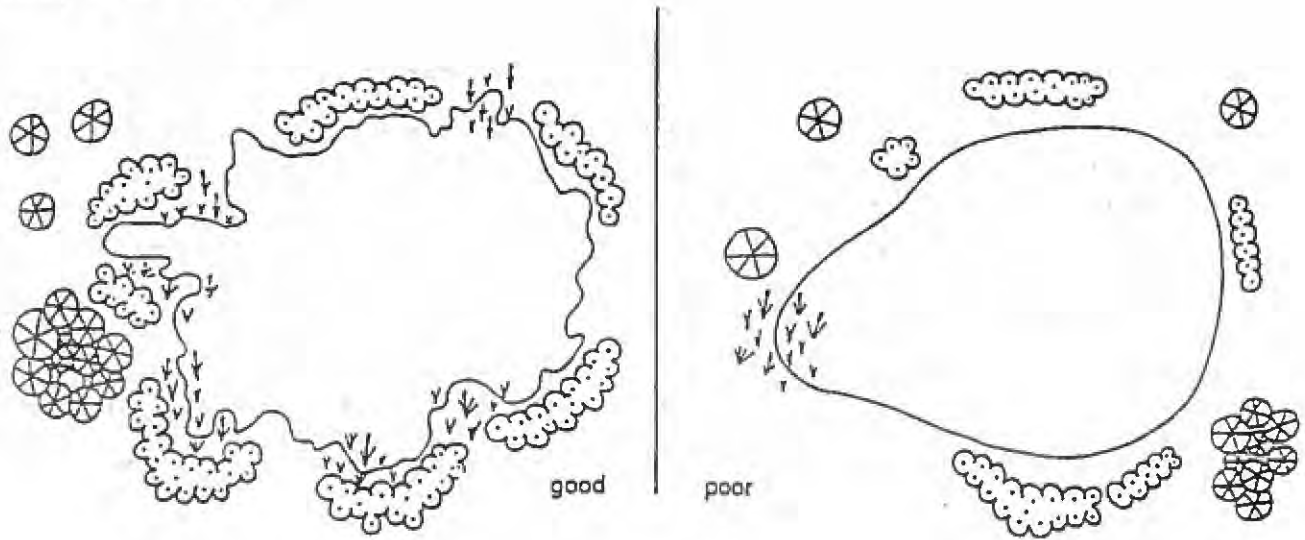
Especially in this part of the state, topsoil from each mine segment should be carefully preserved for reclamation. Once topsoil has been distributed and the seedbed prepared, planting one of the mixes for eastern Washington listed in Table 3 will start the revegetation process. Lupine and clover are recommended because they fix nitrogen and are adapted to a wide range of conditions. However, the characteristics of each site should be evaluated to assure selection of an appropriate seed and plant mix. Generally, vegetation on areas adjacent to the mine indicates what will survive. Shrubs and trees should be selected to complete vegetation of the site (Table 1).

SUBSEQUENT LAND USES

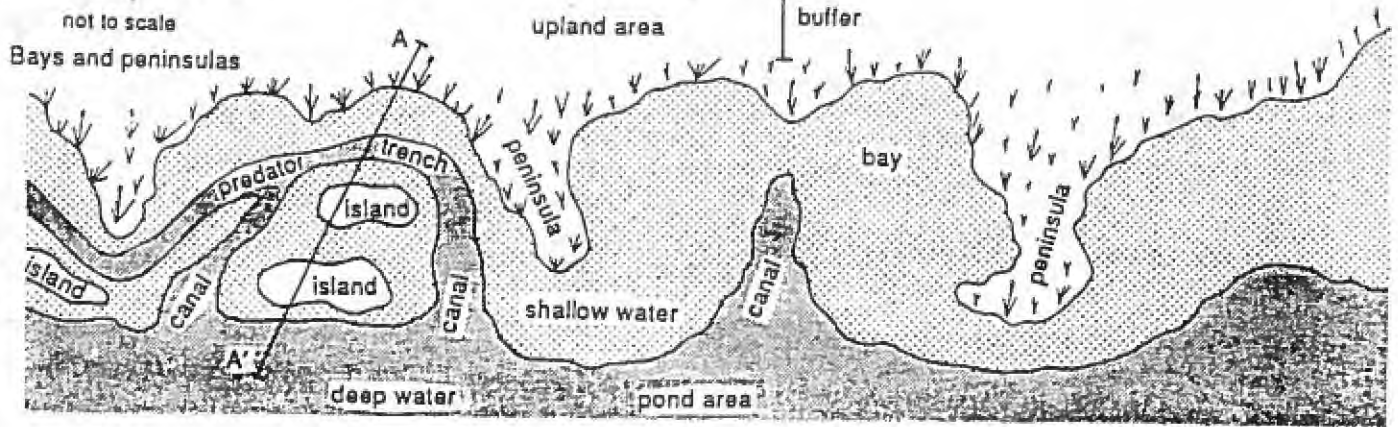
Wetlands and Lakes

Sand and gravel pits in which the pit floor is seasonally or permanently below the water table provide excellent opportunities to create wetlands, lakes, and habitat for wildlife and fish. Productive lakes and wetlands have irregular shorelines and areas of shallow water (Fig. 4; Michalski and others,

Shoreline Irregularity



Typical Plan View



Cross Section

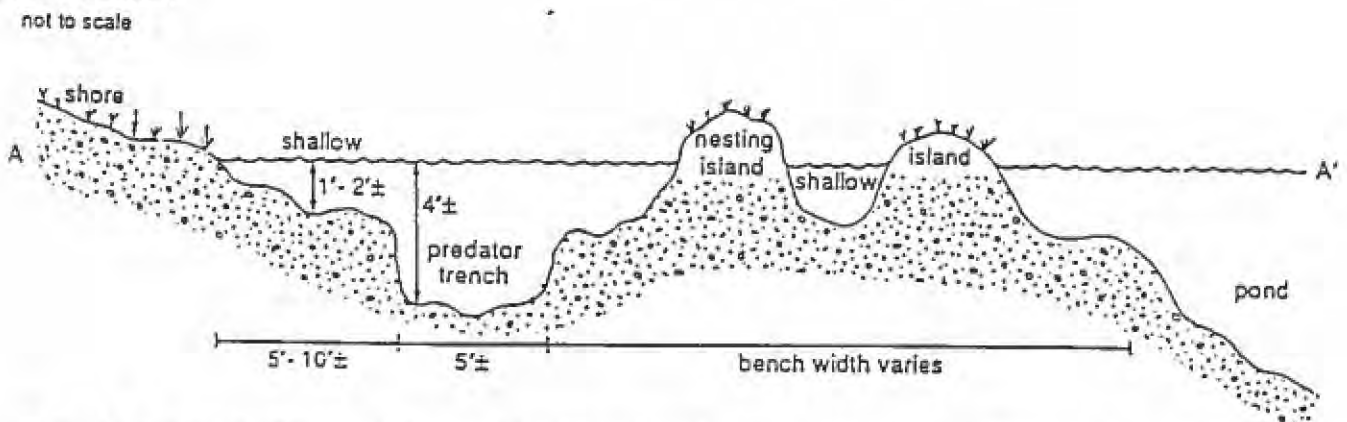


Figure 4. Shoreline Irregularity—Shorelines of ponds in reclaimed mines that will be used as wildlife habitat should be irregular and planted for cover. The shape of the pond on the left is preferred to that of the pond on the right.

Plan view and cross section—Plan and cross section of a well-designed irregular wetland or pond shoreline. Note large areas of shallow water. Steep slopes along parts of the shore will discourage the growth of cattails and emergent plants and provide clear access to the pond. Nesting sites are provided. The trench discourages predators, but the shallow water offers sites for food and cover plantings. Islands can be constructed from fill, unmined material, or sediments saved from digging the trench.

1987; Herricks, 1982). In a typical sand and gravel mine, deep areas from which all the commercial material has been recovered will make up the majority of a lake, but shallow areas must be provided around the margins of the excavation to avoid creating a sterile wetland.

Some recommendations for creating lakes and wetlands that will provide desirable habitat for wildlife and fish are:

- Early use of the lake to dispose of sediment from retention ponds will provide a substrate for aquatic plants.
- Areas where the water is more than 10 feet deep, as well as benches and shoals rimmed by water less than 2 feet deep, should be provided. Ideally, 25 percent of the lake should be shallow and the nearshore lakebed nearly flat, 25 percent 2 to 6 feet deep, and the remainder more than 10 feet deep. Shallow areas may not be desirable or possible in all parts of a lake. However, from a wetland perspective, the more shallow areas, the better.
- Large, unusable material such as boulders can be placed in deep water as cover for fish and a hard substrate for insects, snails, and other invertebrates. Some tree and stump debris from clearing the site can also be placed in lakes. Submerged crowns of trees and brush piles anchored along steep banks provide excellent cover.
- At least half the lake shoreline should be constructed as shown in Figure 4. Shallow shorelines should slope not more than 5H:1V.
- Nesting islands should be more than 3 feet in diameter. Irregular shapes are preferable. More small islands are better than a few large ones. Mine waste or material from canals and predator trenches can be used to construct islands.
- Wherever possible 8 inches of topsoil should be placed on banks, islands, and shallow areas, especially where vegetation is desired.
- Areas of undisturbed, native vegetation along the shoreline (riparian zones) are important to wildlife and fish.

Table 3. Seed mixes and application rates per acre for eastern Washington

Mix 1:		Mix 2:	
Lupine	5 lb	Pubescent wheatgrass	
Indian ricegrass	5 lb	(sod-former)	12 lb
Desert wheatgrass	5 lb	Sheep Fescue (bunchgrass)	6 lb
Thickspike wheatgrass	5 lb	Alfalfa (ladak) or	
Sand dropseed	2 lb	yellow sweetclover	4 lb
Big bluegrass	1 lb	Total	22 lb
Sheep fescue	1 lb		
Total	24 lb		
Mix 3:		Mix 4:	
Sherman big bluegrass		Crested wheatgrass	
(bunchgrass)	8 lb	(bunchgrass)	8 lb
Sheep fescue (bunchgrass)	6 lb	Canby bluegrass	
Alfalfa (ladak) or		(bunchgrass)	6 lb
yellow sweetclover	4 lb	Alfalfa (ladak) or	
Total	18 lb	yellow sweetclover	4 lb
		Total	18 lb
Mix 5 (south and west slopes):		Mix 6 (north and east slopes):	
Crested wheatgrass		Beardless wheatgrass	12 lb
(bunchgrass)	15 lb	Orchard grass	8 lb
Smooth brome	10 lb	Total	20 lb
Cereal rye	15 lb		
Total	40 lb		

Buffers should be at least 100 feet wide along creeks. Buffers need not surround a lake, but the more extensive and continuous the buffer, the better.

- Planting areas along the wetland with native riparian trees and shrubs (poplar, red alder, willow, shore pine, big-leaf maple, western red cedar, western hemlock, Oregon ash) and grasses that provide nesting cover can accelerate restoration of habitat (Washington Department of Ecology, 1990).
- If access for boating, swimming, or fishing is planned, some segments of the shore should slope steeply to limit growth of emergent plants and to facilitate access to the water. Recreational access should be as far from waterfowl nesting habitat as possible.

Mines that are located along rivers and in flood plains must be reclaimed as lakes and wetlands. Erosion and attempts to control the river with dikes or revetments are the main problems associated with these mining operations. When a river changes its course catastrophically, whether as a natural or induced process, the alteration is known as avulsion. If a mine is located on the inside of a meander, the river is likely to avulse when it enters the mine during a flood. The Yakima River moved 1,800 feet laterally during one night when it entered a mine. (See Dunne and Leopold, 1978.) Avulsion can cause severe erosion and property loss. On the other hand, building dikes to prevent avulsion can deflect the river's erosive force to a new location, and dikes can diminish the quality of the subaqueous habitat.

Successful reclamation of mines in these settings depends on site selection and understanding river dynamics, considering both rates of course alteration and erosion as well as the capacity to transport sand and gravel (Collins and Dunne, 1990). Floodplains where rivers have wide meander paths need buffer zones designed to protect against river avulsion and to provide long-term stability for the reclaimed mine.

Upland Wildlife Habitat

If an upland site is to be reclaimed as wildlife habitat, biological diversity is the goal. Appropriate plants should be provided for food and cover for all seasons. Basic vegetative components are:

- Conifers, hardwoods, grasses, and legumes that provide protective seasonal shelter, summer nesting cover, and some food (leaves, seeds, or nuts), and
- Plants that provide nectar or other food for insects.

Structural components listed in Michalski and others (1987) are:

- Nest boxes and nest platforms, dead trees, fallen trees, and other perches or roosts for birds,
- Brush and rock piles for cover and denning for mammals and reptiles,
- Cut banks and irregular pit-floor topography,
- Water, and
- Some open space with only grasses and legumes.

Wildlife management strategies and restricting access to the area will also contribute to successful habitat restoration.

Segmental reclamation facilitates plant communities developing in a range of ecological succession stages. A combination of natural reseeding and intentional planting is the most effective means of establishing diverse and prosperous vegetation for wildlife.



Figure 5. This reclaimed segment of a sand and gravel pit has been replanted for forestry. Mine operator Milt Emerick stands next to a 4-year-old Douglas fir. Before the trees were planted, the pit floor was ripped, and wood chips and bark waste were tilled in to build soil. A grass/legume mix was planted the first year, and in the second, 2-year-old Douglas fir nursery stock was planted.

Trees are the key to useful wildlife habitat. Upland trees most valuable for wildlife are those that bear nuts or berries. However, most reclaimed sites cannot support these types of trees immediately. Conifer plantings should be restricted to small patches because these function principally as wind-breaks and shelter but have little food value. Red alders improve the soil by fixing nitrogen and are good for reclamation west of the Cascades. East of the Cascades, Russian olive and black locust are generally good choices; they also fix nitrogen, but will not survive in dry sites.

Forest Production

Reclamation as forest land can result in revenue and lower taxes for the private landowner. Assistance for reclamation for forestry is available from the DNR regional offices. (See Norman, 1992.) For example, the forestry incentives program allows for a federal cost-sharing of up to \$10,000.

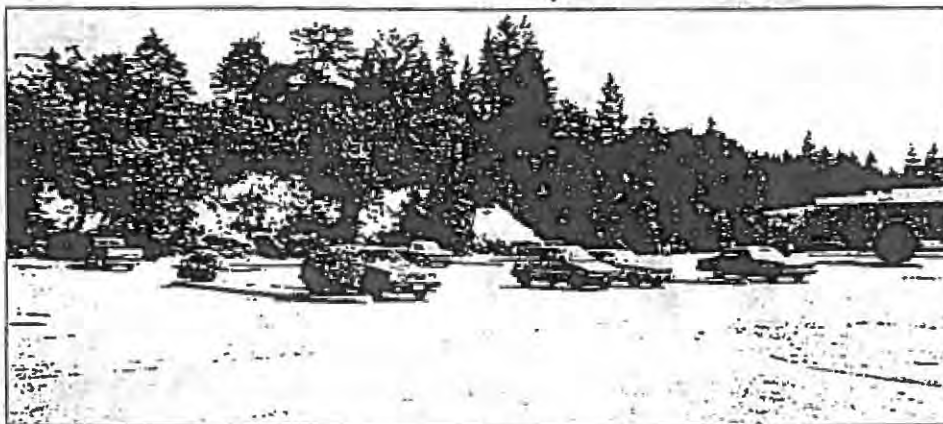


Figure 6. Reclamation of sand and gravel pits for industrial or commercial uses such as shopping centers generally requires less effort than for other subsequent uses because the pit floor is flat and paved. The named slope at this site has been revegetated with both trees and grasses, and the toe of the slope is held by large rocks. Stormwater drainage is directed to deeper parts of the former pit.

Eligible reclamation includes the normal forest practices necessary to establish seedlings, site preparation for natural regeneration, and control of competing vegetation. Most mined properties have the potential for forest production (Fig. 5). However, sites that should not be considered for forestry have some or all of the following characteristics: area less than 10 acres, slopes steeper than 3H:1V, soil depths less than 20 inches over bedrock, or a high permanent water table (unless poplar trees are to be planted in a wet site).

Residential, Industrial or Commercial Uses

Minimum reclamation is required for these uses. Slopes should be stabilized, shaped, drained, and revegetated with a grass/legume mixture (Figs. 6 and 7). Some topsoil replacement may be necessary. The

pit floor must be graded for proper drainage.

Agricultural Uses

Full recovery of mined land to be used for crops takes many years. Reclamation for agriculture requires thorough planning and preparation; essential tasks are initial separation of the A, B, and C soil horizons and restoring topsoil or subsoil that has had minimum degradation. Restored topsoil should be at least 8 inches thick and the subsoil at least 3 feet thick. Loss and damage of topsoil through burial, stockpiling, or moving can be minimized by segmental reclamation. Topsoil should not be stored for prolonged periods.

Proper drainage can be achieved by shaping slopes to eliminate sheet wash. Poor drainage is likely to cause excessively wet soil, which is not desirable for most crops.

Ripping and tilling a pit floor will loosen the surface for planting and is essential for restoring soil porosity and structure. Removing cobbles and large gravel may be necessary before planting some sites.

The first 5 years of reclamation should be dedicated to growing grass/legume mixes in which legumes are the main constituent. During this time, no grazing or harvesting should occur; instead, crops should be tilled into the soil (Mackintosh and Mozuraitis, 1982). Legumes, preferably alfalfa, which is deep rooting, reduce compaction, fix nitrogen, and return organic matter to the soil. (Lupine should not be planted because some species are poisonous to livestock.)

Crops on slopes that range from 6H:1V to 10H:1V are easy to harvest. However, gentle final slopes usually mean that wider setbacks or shallower pits will be required during mining. It

may be preferable to reclaim the north- and east-facing pit margins at the steepest reasonable slope, thus maximizing the area of flat pit floor (Fig. 8). Increased production on flat floors may offset lost production on northern and eastern exposures.

Landfills and Garbage Dumps

Backfilling a sand and gravel mine with household garbage, construction debris, or wood debris is allowed only with written approval of the local health agency. Because sand and gravel deposits are porous and permeable, contaminants travel quickly to ground water, streams, and lakes. Rain supplies oxygen that promotes the growth of methanogenic bacteria. The Department of Natural Resources strongly discourages the use of sand and gravel mines as landfills.



Figure 7. In urban areas, reclaimed sand and gravel pits can accommodate apartment complexes. Slopes at this location have been revegetated with grasses, legumes, and Douglas fir. (Photo by Dave Pierce, Department of Natural Resources, South Puget Sound Region).

REFERENCES CITED

- Collins, B. D.; Dunne, Thomas, 1990, Fluvial geomorphology and river-gravel mining—A guide for planners, case studies included: California Division of Mines and Geology Special Publication 98, 29 p. [Includes some Washington case studies; methods of measuring transport and the effects of gravel extraction are discussed.]
- Coppin, N. J.; Bradshaw, A. D., 1982, Quarry reclamation—The establishment of vegetation in quarries and open pit non-metal mines: Mining Journal Books [London, England], 112 p.
- Dunne, Thomas; Leopold, L. B., 1978, Water in environmental planning: W. H. Freeman and Company, 818 p.
- Dunne, Thomas; Dietrich, W. E.; Humphrey, N. F.; Tubbs, D. W., 1981, Geologic and geomorphic implications for gravel supply. In Proceedings from the conference on salmon-spawning gravel—A renewable resource in the Pacific Northwest?: Washington Water Research Center Report, p. 75-100.
- Herricks, E. E., 1982, Development of aquatic habitat potential of gravel pits. In Svedarsky, W. D.; Crawford, R. D., editors, Wildlife values of gravel pits—Symposium proceedings: University of Minnesota Agricultural Experiment Station Miscellaneous Publication 17-1982, p. 196-207.
- Mackintosh, E. E.; Mozuraitis, E. J., 1982, Agriculture and the aggregate industry—Rehabilitation of extracted sand and gravel lands to an agricultural after-use: Ontario Ministry of Natural Resources Industrial Mineral Background Paper 3, 39 p.
- Michalski, M. F. P.; Gregory, D. R.; Usher, A. J., 1987, Rehabilitation of pits and quarries for fish and wildlife: Ontario Ministry of Natural Resources, Land Management Branch, 59 p.
- Miller, J. E.; Frederick, R. H.; Tracey, R. J., 1973, Precipitation-frequency atlas of the western United States—Vol. IX—Washington: U.S. Department of Commerce National Oceanic and Atmospheric Administration Atlas 2, 43 p.
- Norman, D. K., 1992, Surface mining in Washington—Some regulatory responsibilities of various federal, state, and local government agencies, 1992: Washington Division of Geology and Earth Resources Open File Report 02-5, 22 p.
- Shank, Dale, editor, 1990, Hortus Northwest—A Pacific Northwest native plant directory and journal: Hortus Northwest, no. 2, 50 p.
- Washington Department of Ecology, 1991, Stormwater management manual for the Puget Sound Basin: Washington Department of Ecology Publication #90-73, 1 v.
- Washington State University Cooperative Extension, 1983, Washington interagency guide for conservation and forage planting: Washington State University Cooperative Extension MISC.0058, 70 p.
- *Van Kekerix, Lorraine; Kay, B. L., 1986, Revegetation of disturbed land in California—An element of mined land reclamation: California Division of Mines and Geology Open-File Report S6-14, 105 p. ■



Figure 8. Segment of a mine reclaimed for agriculture is shown with a cut slope at the right edge. Active mining continues (top of photo). The productive agricultural area is the flat pit floor, which has been planted in raspberries. Steep areas in the raspberries are caused by poor drainage. The steep (3H:1V) banks maximize productive agricultural land and are planted with a grass/legume mix. (Photo by Jeff Griffin, Whatcom County Planning Department.)

STATE OF OREGON
DEPARTMENT OF ENVIRONMENTAL QUALITY

Recommended Best Management Practices for Storm Water Discharges

Guidance for Eliminating or Reducing
Pollutants in Storm Water Discharges
Associated With Industrial Activity



August 1993
Document No. IW\WC11\WC11727.5

TABLE OF CONTENTS

1.0	INTRODUCTION.....	1
2.0	STORM WATER BEST MANAGEMENT PRACTICES BY ACTIVITY.....	2
2.1	Outside Storage of Raw Materials, Intermediate Products, By-Products, or Finished Products.....	3
2.2	Outside Container Storage & Waste Disposal.....	5
2.3	Loading and Unloading Materials.....	8
2.4	Emergency Spill Response and Cleanup Plans.....	10
2.5	Above-Ground Tank Storage.....	12
2.6	Outside Manufacturing Activity.....	14
2.7	Fueling Stations.....	15
2.8	Vehicle and Equipment Washing.....	17
2.9	Vehicle and Equipment Maintenance.....	18
2.10	Sandblasting and Painting Operations.....	20
2.11	Inspection and Monitoring Activities	22
2.11.1	Equipment and Process Areas.....	22
2.11.2	Storm Water Facilities.....	22
2.12	Dust Control.....	23
2.12.1	Land Disturbance & Demolition Activities.....	23
2.12.2	Material Handling Activities.....	23
2.13	Erosion and Sediment Control.....	24
2.13.1	Erosion Control Practices.....	24
2.13.2	Sediment Control Practices.....	30
3.0	BEST MANAGEMENT PRACTICES BY NPDES PERMIT TYPE.....	33
3.1	#1200-A.....	34
3.2	#1200-D.....	36

3.0	BEST MANAGEMENT PRACTICES BY NPDES PERMIT TYPE <i>continued</i>	
3.3	#1200-F.....	37
3.4	#1200-G	38
3.5	#1200-H	39
3.6	#1200-L	41
3.7	#1200-M.....	43
3.8	#1200-P.....	45
3.9	#1200-R	47
3.10	#1200-S.....	49
3.11	#1200-T.....	51
3.12	#1200-W.....	53
4.0	ADDITIONAL RESOURCES.....	55
4.1	Document List	55
4.2	DEQ Contacts	56
4.3	Other Agencies.....	57

LIST OF FIGURES AND TABLES

2-1A	Outside Storage Details.....	4
2-2A	Container Storage.....	7
2-3A	Loading and Unloading Liquid Materials.....	9
2-5A	Tank Storage System.....	13
2-7A	Covered Fuel Island.....	16
2-13A	Effect of Vegetation on Storm Water Runoff.....	25
2-13B	Orientation of Netting and Matting.....	27
2-13C	Level Spreader.....	28
2-13D	Rock Outlet Protection.....	29
2-13E	Filter Fabric Silt Fence.....	31
2-13F	Stabilized Construction Entrance.....	32
4-1A	Table of DEQ Locations.....	57

2.4 EMERGENCY SPILL RESPONSE AND CLEANUP PLANS

Every facility should maintain an appropriate Emergency Spill Response and Cleanup Plan for all material handling activities on the site. Areas where spilled materials can impact storm water runoff and their associated drainage points should be clearly identified. Methods to prevent spills along with cleanup and notification procedures should be identified in the plan and made available to appropriate personnel. The required cleanup equipment must be on site or readily available. An employee trained in spill containment and cleanup should be present during loading and unloading of materials.

In addition, owners of certain non-transportation related facilities must prepare a Spill Prevention Control and Countermeasure Plan. These facilities include those involved in storing, processing, or refining oil and oil products which have above-ground storage capacity in excess of 1,320 gallons or a single container in excess of 660 gallons, or have underground storage capacity in excess of 42,000 gallons, or due to location could reasonably expect spilled oil to reach waters of the United States or adjoining shorelines. Please see 40 Code of Federal Regulations (CFR) Part 112 or call EPA at 1-800-424-4EPA for more information about this requirement.

The NPDES storm water discharge permits also requires that spill prevention and response procedures for any significant material present at the site be described in the facility's storm water pollution control plan. In addition Oregon Administrative Rule (OAR) 340-108, *Oil and Hazardous Material Spills and Releases*, further specifies spill reporting requirements, cleanup standards and liability that attaches to an actual or threatened spill or release involving oil or hazardous material.

The DEQ, EPA and U.S. Coast Guard all require that spill contingency plans be prepared for oil transferring and storage facilities according to the specific requirements set forth in their rules. DEQ rules may be found in OAR 340-47, *Regulations Pertaining to Oil Spills Into Public Waters*. The EPA requirements may be found in 40 CFR Part 112. In response to the Oil Pollution Act of 1990, EPA recently proposed amendments to 40 CFR Part 112 which may be found in Federal Register Volume 58, No. 30, February 17, 1993. The U.S. Coast Guard's interim rules may be found in Federal Register Volume 58, No. 23, February 5, 1993. Although the requirements from each agency are somewhat similar there are differences in planning volumes for worst case spills, initial response times, and recovery standards. For more information please contact the Department of Environmental Quality.

The following guidelines are recommended in preparing a Spill Prevention Control and Countermeasure Plan and are also useful when preparing the section of the storm water pollution control plan that addresses spills:

1. Describe the facility, provide the owner's name and address, describe the nature of the activities at the facility, and indicate the general types of chemicals used on the site.
2. Provide a site plan showing the location of chemical storage areas, the location of storm drains, the direction of the slope of the site toward the drains, and the location and description of any structures or devices on the site, such as control valves or lined sumps, to prevent spills from leaving the site.
3. Provide notification procedures that will be used in the event of a spill for contacting key personnel and local and state government agencies.

4. Provide detailed instructions regarding cleanup procedures, including how to handle fires and explosions should they occur.
5. List the designated person with overall spill response cleanup responsibility.
6. Describe the training program that will be implemented for key personnel. All employees at the facility should have basic knowledge of spill control procedures.
7. Provide a summary of the spill cleanup plan that will be posted at appropriate points throughout the work place. The summary should identify the spill cleanup coordinators, the location of cleanup kits, and phone numbers of regulatory agencies to be contacted in the event of a spill.
8. If a spill occurs, cleanup should begin immediately. No emulsifier or dispersant shall be used. If the spill could reach sanitary or storm sewers or surface waters, local and state government officials should be notified immediately.
9. Provide information about the cleanup kit(s) located at the site. The contents of the kit should be appropriate for the type and quantities of chemicals stored at the facility. The kit may contain the following: lined drums, absorbent pads, and granular or powdered materials for neutralizing acids or alkaline liquids. The kits should be located in a manner that allows easy access and use by employees, and drills should be practiced to ensure quick and effective response.

2.9 VEHICLE AND EQUIPMENT MAINTENANCE

Since many industrial facilities maintain vehicles and equipment, storm water can easily become contaminated with solvents, oil, grease, waste automotive fluids, acids, and caustic wastes. These substances are harmful to aquatic life, and measures should be implemented to prevent storm water contamination.

The following practices are recommended:

1. Clean vehicle and equipment parts without using solvents. This will save on disposal costs since many solvents must be disposed of as hazardous wastes. Parts can be scraped with a wire brush or placed in a bake oven for cleaning. If solvents are used, designate a centralized cleaning station to keep solvents and residues in one location. Use drip pans, drain boards, and drying racks to direct drips and spills into a fluid holding tank for reuse.
2. Use nontoxic or less toxic solvents and cleaners. Examples include using non-caustic detergents for parts cleaning and using detergent-based or water-based cleaning systems instead of organic solvent degreasers.

Replace chlorinated organic solvents, such as 1,1,1-trichloroethane or methylene chloride, with non-chlorinated solvents such as kerosene or mineral spirits. If the list of active ingredients on the solvent container includes the term "chlor," then the solvent is chlorinated.

Use cleaners that can be recycled if possible. The supplier of the cleaners and solvents along with trade journals for the industry can provide information regarding waste minimization for these activities.

3. Do not use running water from a hose to clean the work areas because the contaminated water could enter the storm drainage system and ultimately surface water bodies. Rags or spill pads can be used for cleaning small spills and a damp mop can be used for general cleaning. Contact the local public works department before discharging the mop water into the sanitary sewer. Sorbent materials including kitty litter, sawdust, spill pads and spill booms may be used for containing large spills. Dispose of clean up materials appropriately.
4. Place a drip pan underneath vehicles and equipment when performing maintenance such as removing parts, unscrewing filters, or unclipping hoses. Promptly transfer the used fluids to the proper waste or recycling drums. Open containers, including full drip pans, should not be left lying around on the site.
5. Do not pour used or leftover cleaning solutions, solvents, and automotive fluids into storm drain inlets or ditches, floor drains, sinks, or into the sanitary sewer due to the toxicity of the substances. Floor drains, even those under cover, are frequently connected to the storm drainage system. Floor drains which are connected to storm sewer should be plugged or, with the permission of the local sanitary authority, routed to sanitary sewer. Post signs at these potential discharge points to educate employees so that the wastes are not disposed of improperly.

Contact the distributor of leftover materials to see if unused portions can be returned. In the future purchase only the material needed, do not stockpile. Contact the DEQ Hazardous Solid

Waste Division at (503)229-5913 for information about disposal and recycling options.

6. Place used oil filters in funnels over the waste oil recycling or disposal collection tank to drain excess oil. Crush and recycle used oil filters if possible.
7. When vehicles are driven to the site for repair, examine them for discharge of leaks. Place drip pans under the vehicles to collect fluids for recycling or proper disposal. Designate a central area on the site for draining and replacing motor oil, coolant, and other fluids. This area should be easily cleaned of spills and leaks. Further, storm water runoff from this area should not be allowed to drain into the storm drainage system, and the local public works department should be contacted prior to discharging the runoff into the sanitary sewer.
8. If damaged equipment or wrecked vehicles arrive on the site, drain and collect all engine and transmission fluids. If the equipment or vehicles were drained prior to arrival at the site, place drip pans under them immediately to contain leakage since oils and other fluids may drip for several days. Dispose or recycle all fluids appropriately.

(Note: Air conditioning systems must be emptied by certified technicians. For more information about freon recovery regulations, please contact the EPA at 1-800-296-1996.)

9. Build a shed or roof over areas used for parking equipment or vehicles that need repair or are retained for parts supply.
10. Store all cracked batteries in a non-leaking secondary container to retain acid leaks.
11. Consider recycling used materials such as degreasers, oil or oil filters, antifreeze, cleaning solutions, automotive batteries, and hydraulic fluid. Separate wastes to reduce treatment costs and make recycling efforts easier. For example, keep chlorinated solvents separate from non-chlorinated solvents, separate hazardous and non-hazardous wastes, and do not mix used oil and solvents. Discuss waste separation techniques with the waste hauler or recycling company for the site.
12. Discuss pollution prevention measures with employees and seek their suggestions on waste reduction. Consider incentives for employees, such as a reward program, to promote pollution prevention.
13. Maintain an Emergency Spill Response and Cleanup Plan (see Section 2.4).

2.13 EROSION AND SEDIMENT CONTROL

This section is intended for those industrial facilities which may have areas of landscaping or exposed soils that are subject to the erosive action of wind or water. It is not intended to be used as guidance for large scale construction projects.

Erosion is the process by which soil particles are loosened and displaced by the action of water or wind on the soil surface. The loosened particles are called sediment, and the deposition of this material in streams is called sedimentation. Sedimentation and turbidity associated with sediment laden flows degrade water quality. Turbidity in water interferes with photosynthesis and sediment silts in fish spawning beds and clogs the gill passages of fish.

Over time, erosion control is more effective than sediment control in preventing water quality problems. Erosion control is less subject to failure due to high flows, requires less maintenance, and is also less costly. In some cases a combination of erosion control and sediment control may be required. The following best management practices can be used for areas on industrial sites with exposed soil due to steep slopes, soil stockpiles, heavy equipment traffic, or minor construction projects. Regular inspection and prompt maintenance are critical to the success of all the practices in this section. The selection of an appropriate measure will depend on the degree of slope on the site, sensitivity of the area to the intended use, stream or wetland features in the area, and type of soil encountered.

Please note that construction activities, including clearing, grading and excavation, which disturb five (5) or more acres require NPDES general storm water permits. The five acre limit is currently being reviewed by EPA and may be lowered. Please contact the DEQ for further information. See Section 4.1 and Table 4-1A.

2.13.1 Erosion Control Practices

The following are recommended erosion control practices:

- A. *The preservation of existing vegetation on the site.* Preserving the existing vegetation is frequently the best preventative measure for erosion. Because native or existing vegetation is already established, it is usually a better cover species than introduced species. Where possible, establish "do not disturb" zones on your site. See Figure 2-13A.
- B. *The implementation of vegetative and soil protection practices for soils that are already exposed.* These practices reduce erosion potential in several ways. They shield the soil from the direct impact of rainfall or runoff, increase soil porosity and water storage capacity of the soil, reduce the energy of the runoff, and physically hold the soil in place with the root system of the vegetation. Vegetative erosion controls include:
 - The establishment of *vegetative cover*, either as a permanent cover or as a temporary measure prior to permanently stabilizing the area. Vegetative buffers or complete coverage can provide a significant reduction of erosion potential. This can be accomplished by seeding, seeding and mulching, seeding and matting, or sodding. Maintenance may be required to successfully vegetate an area. This practice is not suited for areas which carry heavy traffic.

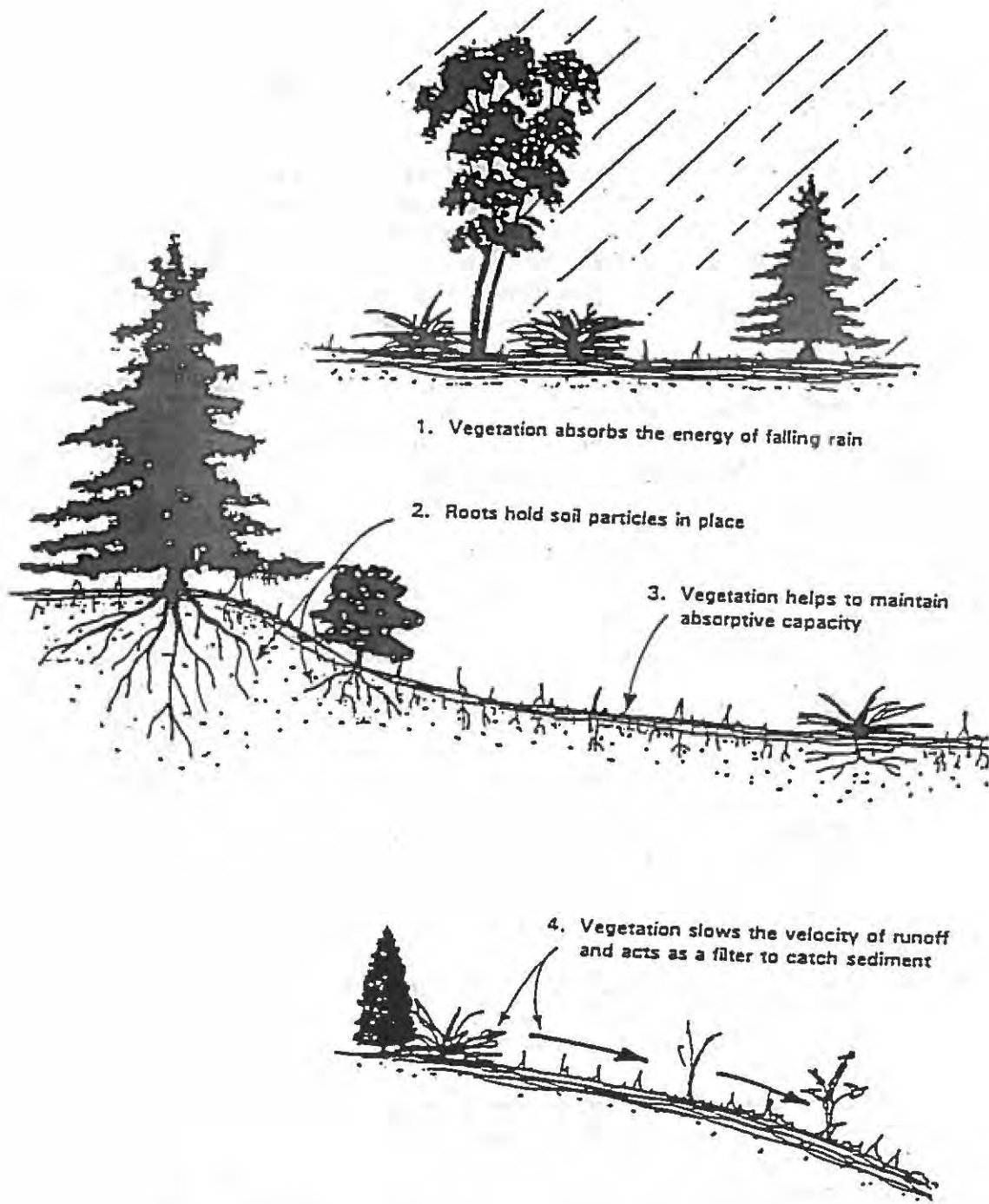


Figure 2-13A: Effect of Vegetation on Storm Water Runoff
(From Washington Department of Ecology, WA, Stormwater Management Manual for the Puget Sound Basin, February 1992.)

2.13.1 Erosion Control Practices *continued*

B. *The implementation of vegetative and soil protection practices for soils that are already exposed. (continued)*

- The use of *mulching or erosion control mats or netting* to physically protect exposed soils. This is a short term measure designed to provide immediate protection until a more permanent stabilization measure can be implemented. Heavy traffic areas are not well suited to this type of protection. This option requires close attention to installation procedures, and may be expensive in large scale applications. It can be very effective, however, if an appropriate medium is selected for a given site. *See Figure 2-13B.*

C. *The installation of structural controls to reduce the energy of the water flowing across soils, or to divert flows from exposed areas.* Reducing the energy of runoff streams is beneficial in that slower flows do not act as strongly in eroding the soils, and they do not carry as much sediment from the site. These controls are not generally successful as stand alone measures, but may enhance the effectiveness of other erosion reduction measures. Structural erosion control measures include the following:

- The use of *level spreaders or interceptor dikes and swales* for long, exposed slopes or at the tops of shorter slopes. The velocity of the runoff can be reduced, and flows diverted from exposed areas by utilizing this type of structural control. Proper installation and use of outlet protection are critical to the success of this type of control. Choice of measure and spacing depend on the degree and length of the slope being addressed. *See Figure 2-13C.*
- The use of *pipe slope drains* to remove excess water or divert runoff from slopes or saturated soil areas, reducing the potential for erosion. The inlets and outlets should be properly designed for adequate stabilization. The outlet area is particularly important, as the higher velocity water at the end of pipe can be an extremely erosive force. Outlet design and correct installation are the keys to the success of this type of control.
- The installation of *outlet protection* at all pipe, ditch or channel discharge points to help prevent scouring in the receiving stream or discharge area. Proper installation of stone, riprap, aprons or detention basins will allow the energy of the discharge to dissipate without eroding the surrounding soils. *See Figure 2-13D.*
- The use of *check dams* to reduce scouring and gulying in small channels. Dams can be built from stone, logs, etc., and can be temporary measures or permanent installations. Dams should be spaced so that the top of the downstream dam is at the same elevation as the toe of the upstream dam. It is important that the center section of the dam be lower than edges. If the edges are lower or at the same elevation as the center the chance for washouts at the ends increases dramatically.

These structures also tend to act as sediment control structures, so it is important that they be inspected and maintained regularly to insure adequate performance. Excessive sediment build-ups must be removed in order for the dam to be most effective.

2.13.1 Erosion Control Practices *continued*

C. *The installation of structural controls to reduce the energy of the water flowing across soils, or to divert flows from exposed areas. (continued)*

- *Stream bank stabilization* to control erosion from the areas along streams where vegetative practices are not feasible. Riprap, gabions, reinforced concrete structures such as bulkheads or retaining walls, or other measures should be designed by a licensed professional engineer to insure adequacy and effectiveness.
- *Paving or graveling of roadways and driveways* to help reduce soil disturbance.

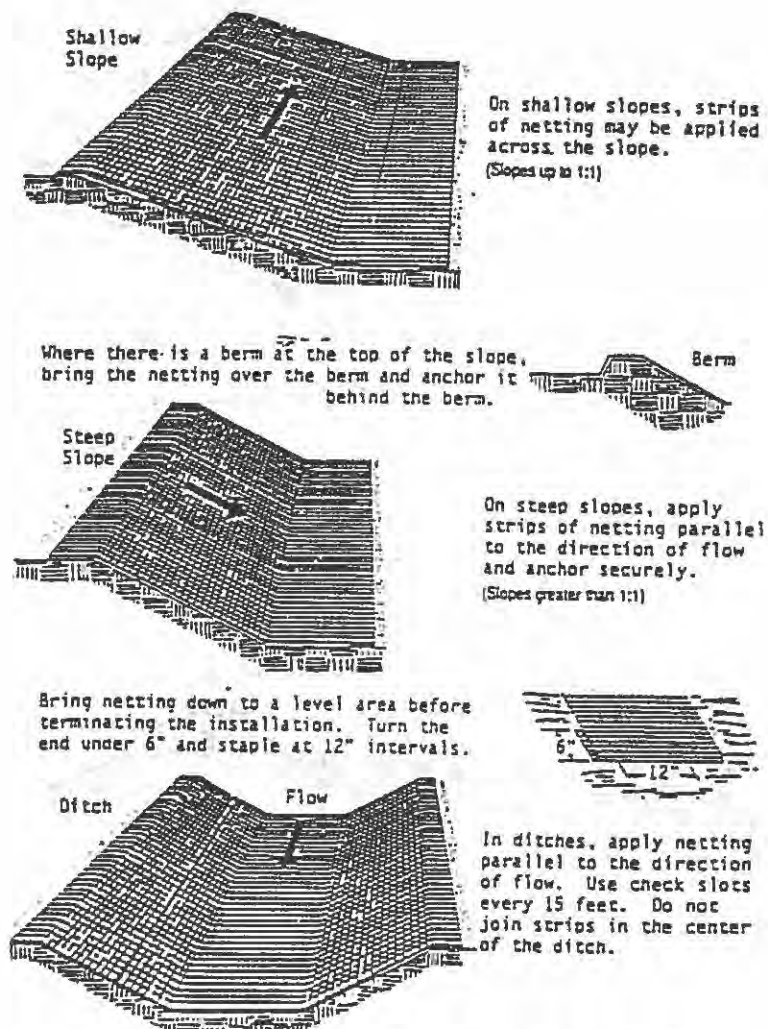


Figure 2-13B: Orientation of Netting and Matting
(From Washington Department of Ecology, WA, Stormwater Management Manual for the Puget Sound Basin, February 1992.)

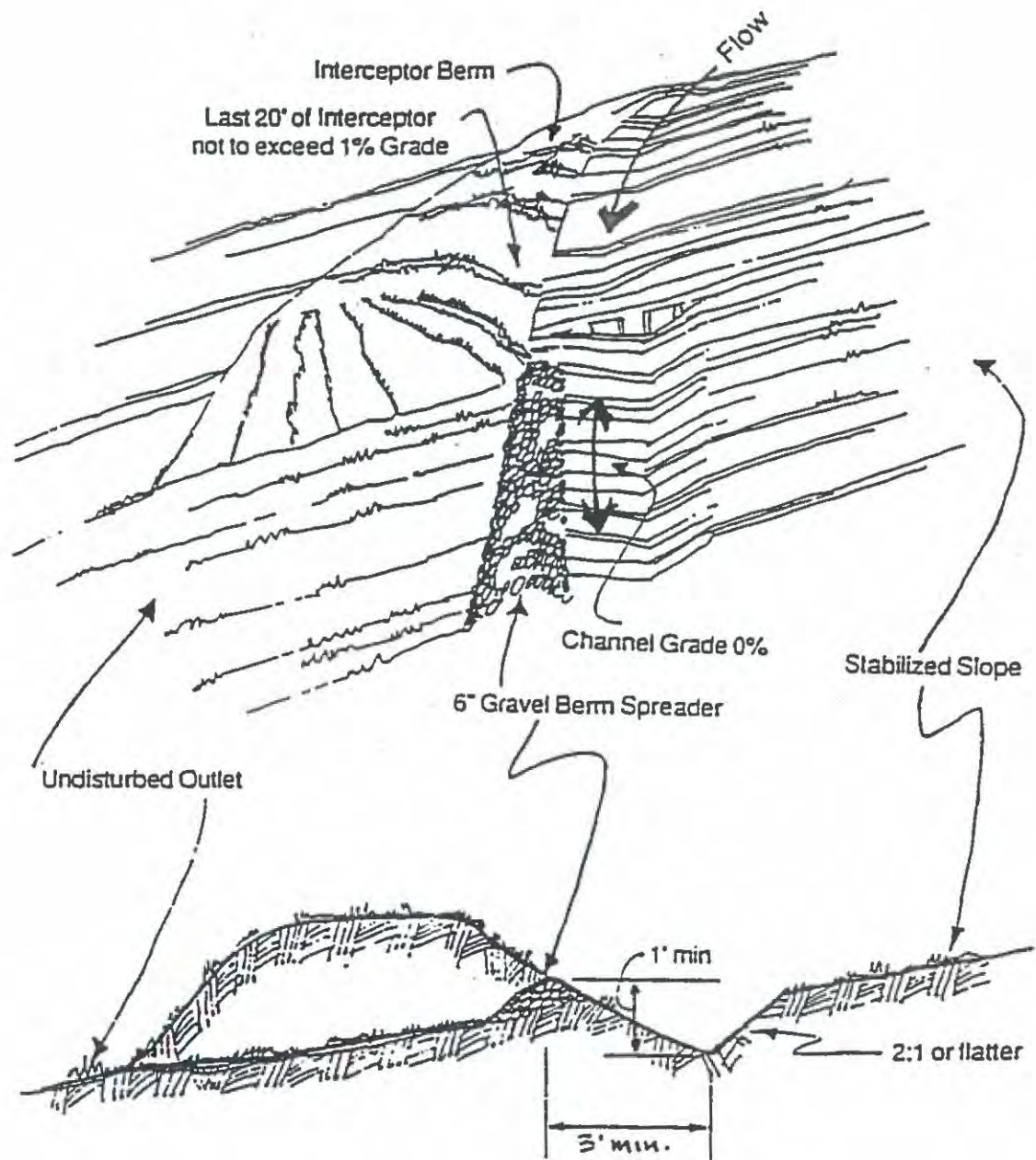


Figure 2-13C: Level Spreader
 (From Washington Department of Ecology, WA, Stormwater Management Manual for the Puget Sound Basin, February 1992.)

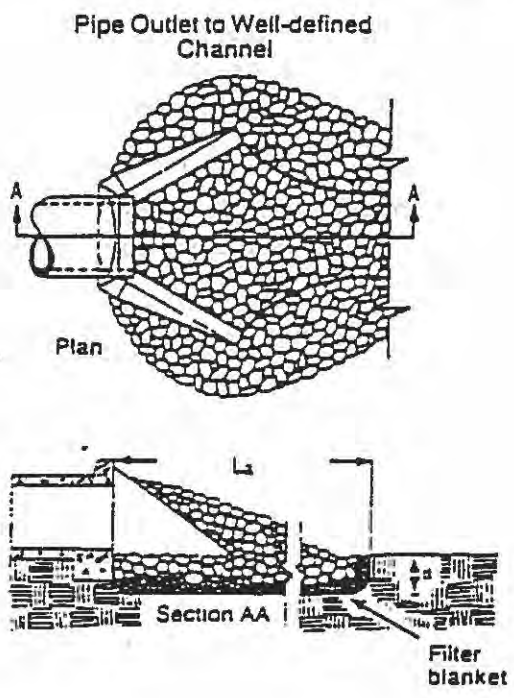
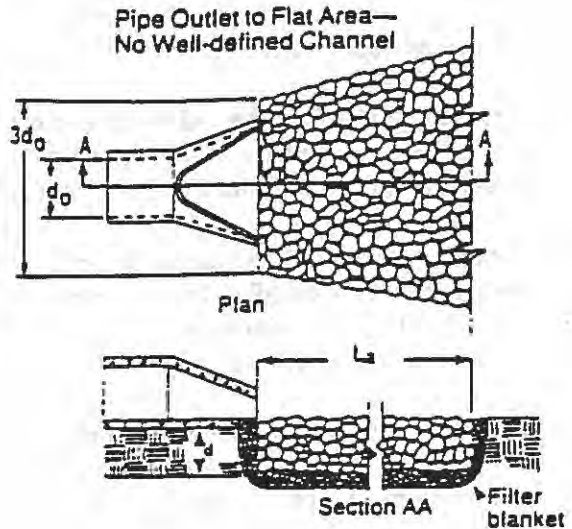


Figure 2-13D: Rock Outlet Protection
 (Modified from U.S. Environmental Protection Agency, Storm Water Management for Industrial Activities, September 1992)

2.13.2 Sediment Control Practices

The following are recommended sediment control practices:

- A. *The use of vegetation to retard the velocity of sediment laden flows.* Using vegetated swales or vegetated buffer strips to intercept runoff helps reduce the energy of the stream, allowing sediment to settle out and be captured by the vegetation.
- B. *The installation of structural controls to trap sediment, reduce stream energy, and allow for settling of turbid waters.* Structural controls include measures designed to physically trap sediment or allow sediment to settle out of runoff. Specific measures include the following.
 - *Filter fabric silt fences* are effective short term controls for trapping sediment and filtering sediment laden flows. A properly installed fence can be a good way to provide some protection on short notice. Prompt maintenance and repair can extend the life span of fences until erosion control measures have been established. *See Figure 2-13E.*
 - *Detention basins or settling basins* can be used in conjunction with outlet protection, ditching and other measures to provide a way to slow down the velocity of a stream and allow the sediments to settle out of turbid flows. An appropriately designed outlet that filters the basin effluent is a very effective way to enhance the performance of such controls.
 - *Check dams*, mentioned in the erosion control section, can be used to reduce channel velocities and capture sediment as it settles out. These must be designed and built with care to insure that the structure will enhance the erosion and sediment control and not create additional problems.
 - *Constructing paved or rocked roads or entrances* can reduce the amount of mud and sediment that is tracked onto areas where the material could be washed into the storm drainage system. *See Figure 2-13F.*

Additional information or installation details can be found in a variety of documents, some of which may be found in Section 4.0.

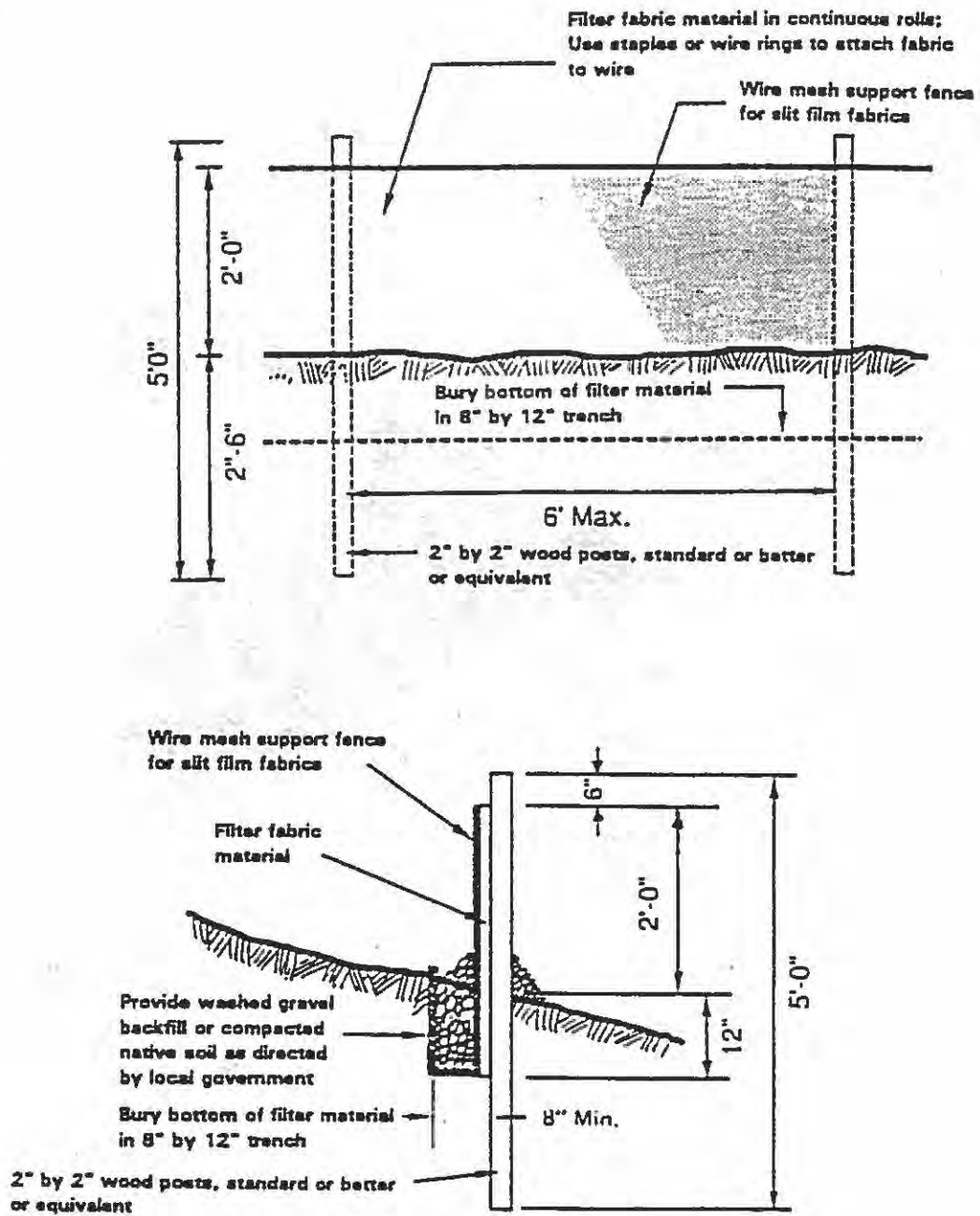


Figure 2-13E: Filter Fabric Silt Fence
 (From Washington Department of Ecology, WA, Stormwater Management Manual for the Puget Sound Basin, February 1992.)

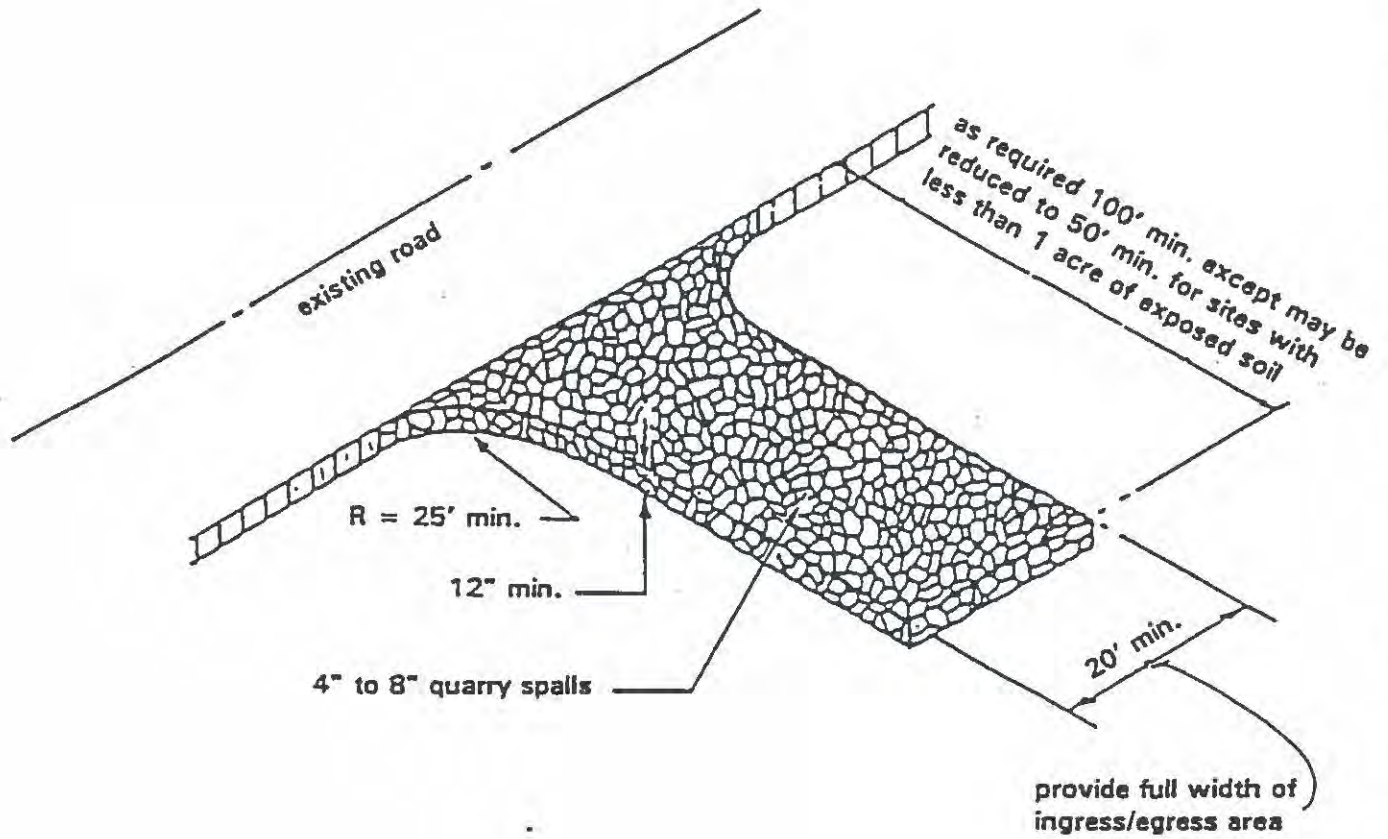
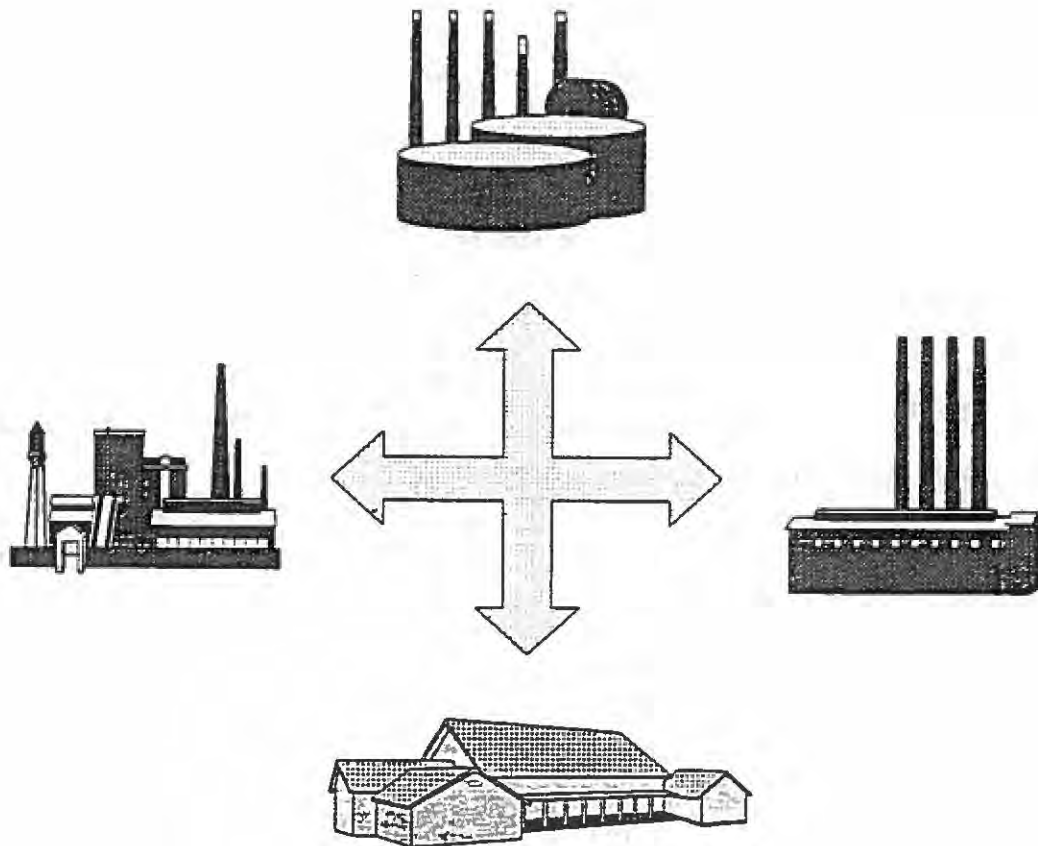


Figure 2-13F: Stabilized Construction Entrance
 (From Washington Department of Ecology, WA, Stormwater Management Manual for the Puget Sound Basin, February 1992.)

3.0 BEST MANAGEMENT PRACTICES BY NPDES PERMIT TYPE

The following sections correspond to the different National Pollutant Discharge Elimination System (NPDES) General Storm Water Discharge Permits issued to different industries in Oregon. Each section contains a short description of the types of facilities covered by the permit, the potential sources of storm water contamination, and also refers to previous chapters for the recommended best management practices for preventing the pollution of storm water.

Facilities in similar industries may participate in very different activities. These sections are only intended to be used as a general reference point to begin storm water pollution control planning. Additional best management practices, discussed in Section 2.0, may be necessary if other activities taking place at the site are not included in the permit categories below.



3.1 GENERAL NPDES PERMIT #1200-A

Industrial facilities covered under this permit include sand, gravel and other nonmetallic mineral quarrying and mining operations. These sites are generally described by Standard Industrial Classification (SIC) code Major Group 14, *Mining and Quarrying of Nonmetallic Minerals, Except Fuels*. Also covered by this permit are related activities at the site such as asphalt mix batch plants (SIC 2951), ready-mix concrete plants (SIC 3273), and vehicle maintenance facilities.

3.1.1 1200-A Potential Sources of Storm Water Contamination

Mineral mining operations often involve large surface areas, including the mine, the process facility locations, and access roads. Storm water can easily become contaminated after contact with these areas on the site, and the runoff may contain various minerals, silt, sand, clay, organic matter, fuels, oil and grease, and other suspended solids. Since raw materials are stockpiled for both ready mix concrete plants and asphalt mix batch plants, storm water runoff can easily become polluted on these sites. The spillage of mix water and the cleaning of the mixer truck chute at the ready mix concrete plant can also contaminate runoff. In summary, storm water at these sites can become contaminated by contact with the following:

1. excavated minerals placed in stockpiles;
2. bare land that surrounds quarries and process facilities due to the use of heavy machinery that destroys vegetation;
3. the transportation of minerals in open vehicles;
4. spills or leaks of fuels and oils from equipment and trucks on the site; and
5. wash waters from equipment cleaning on the work area, including truck wash-out.

Dewatering at a quarry site is not a storm water discharge and is not covered under the #1200-A. Dewatering activities must be covered under separate permit if the dewatering discharges are turbid.

3.1.2 1200-A Recommended Best Management Practices

- *See Section 2.1: Outside Storage of Raw Materials, Intermediate Products, By-Products, or Finished Products*

Note:

Since mining operations cover large areas, covering stockpiles of excavated stone with roofed structures or tarps is both costly and impractical as a best management practice. The following should also be considered:

- A. Divert storm water runoff from outdoor storage areas. For example, construct grassed ditches around the perimeter of the storage area to collect the runoff, with further treatment (if needed) in a detention pond to remove pollutants prior to discharge to surface waters. The methods for collection and treatment of the runoff will depend on the particular pollutants detected through monitoring.

3.1.2 1200-A Recommended Best Management Practices *continued*

B. Segregate the operations or processes that will produce the most significant source of pollutants on the site. Once this determination has been made, it may be possible to divert storm water runoff from these areas to prevent contamination.

C. Place covers over vehicles transporting materials either for processing or from the site. For example, trucks used to haul minerals from the mine to the processing area should have covered beds to prevent storm water contact with the minerals. Covering would also apply to train cars and other transportation options.

- *See Section 2.8: Vehicle and Equipment Washing*
- *See Section 2.9: Vehicle and Equipment Maintenance*
- *See Section 2.17: Fueling Stations*
- *See Section 2.11: Inspection and Maintenance of Storm Drainage Facilities*
- *See Section 2.13: Erosion and Sediment Control*

3.2 GENERAL NPDES PERMIT #1200-D

Industrial activities covered under this permit include textile and apparel manufacturing, printing, and warehousing facilities. Textile and apparel manufacturing facilities are described by Standard Industrial Classification (SIC) Code Major Group 22, *Textile Mill Products*, and SIC Code Major Group 23, *Apparel and Other Finished Products Made From Fabrics and Similar Materials*. Printing activities are covered by SIC Major Group 27, *Printing, Publishing, and Allied Industries*, and warehousing facilities are covered by SIC Major Group 42, *Motor Freight Transportation and Warehousing*.

3.2.1 1200-D Potential Sources of Storm Water Contamination

Under the permitting program, industrial facilities within this classification are required to obtain a storm water discharge permit if storm water runoff is exposed to raw materials, material handling equipment or activities, intermediate products, final products, waste materials, by-products, or industrial machinery. Storm water discharges can become contaminated by contact with:

1. outside storage or spillage of raw materials, chemicals, and wastes produced from the various processes;
2. vehicle or equipment washing activities;
3. fueling and vehicle maintenance areas;
4. shipping and receiving areas; and
5. material handling activities and equipment.

3.2.2 1200-D Recommended Best Management Practices

- *See Section 2.1: Outside Storage of Raw Materials, Intermediate Products, By-Products, or Finished Products*
- *See Section 2.2: Outside Container Storage and Waste Disposal*
- *See Section 2.3: Loading and Unloading Materials*
- *See Section 2.4: Emergency Spill Response and Cleanup Plans*
- *See Section 2.8: Vehicle and Equipment Washing*
- *See Section 2.9: Vehicle and Equipment Maintenance*
- *See Section 2.10: Fueling Stations*
- *See Section 2.11: Inspection and Monitoring Activities*

3.3 GENERAL NPDES PERMIT #1200-F

Industrial facilities covered under this permit include food processing establishments, such as meat products; dairy products; canned, frozen, and preserved fruits, vegetables, and food specialties; grain mill products; bakery products; sugar and confectionery products; fats and oils; beverages; and miscellaneous food preparations. These types of facilities are assigned Standard Industrial Classification (SIC) Major Group 20, *Food and Kindred Products*.

3.3.1 1200-F Potential Sources of Storm Water Contamination

Under the permitting program, industrial facilities within this classification are required to obtain a storm water discharge permit if storm water runoff is exposed to raw materials, material handling equipment or activities, intermediate products, final products, waste materials, by-products, or industrial machinery.

The following activities serve as examples of ways in which storm water discharges can become contaminated by contact with:

1. animals, including their feeding areas and waste discharges;
2. chemicals or preservatives, if stored outdoors;
3. the transportation of raw or intermediate materials or products to or from the site;
4. raw vegetables and fruits; and
5. vehicle or equipment washing activities, such as cleaning dairy tanks or trucks.

3.3.3 1200-F Recommended Best Management Practices

- *See Section 2.1: Outside Storage of Raw Materials, Intermediate Products, By-Products, or Finished Products*
- *See Section 2.2: Outside Container Storage and Waste Disposal*
- *See Section 2.3: Loading and Unloading Materials*
- *See Section 2.4: Emergency Spill Response and Cleanup Plans*
- *See Section 2.5: Above-Ground Tank Storage*
- *See Section 2.7: Fueling Stations*
- *See Section 2.8: Vehicle and Equipment Washing*
- *See Section 2.9: Vehicle and Equipment Maintenance*
- *See Section 2.11: Inspection and Maintenance of Storm Drainage Facilities*

3.4 GENERAL NPDES PERMIT #1200-G

Industrial facilities covered under this permit include landfills and open dumps, as well as associated activities ongoing at these sites such as leachate treatment and disposal facilities, waste container staging areas, soil stockpiling areas, and vehicle maintenance facilities.

3.4.1 1200-G Potential Sources of Storm Water Contamination

Storm water can become contaminated by contact with the following:

1. exposed materials and parts that may be covered with oil, grease, chemicals, metals, bacteria or other pollutants;
2. materials that have been spilled or have leaked, such as oil, grease, gasoline, antifreeze, etc.
3. eroded soil exposed due to the activity of heavy machinery on the site, and burying and covering waste materials;
4. waste stockpiles;
5. waste materials as they are transported to and from the site;
6. process wastewaters resulting from cleaning of parts or waste materials; and
7. wash waters resulting from cleaning vehicles, storage containers, etc.

3.4.2 1200-G Recommended Best Management Practices

See Section 2.2: Outside Container Storage and Waste Disposal

See Section 2.3: Loading and Unloading Materials

See Section 2.4: Emergency Spill Response and Cleanup Plans

See Section 2.5: Above-Ground Tank Storage

See Section 2.7: Fueling Stations

See Section 2.8: Vehicle and Equipment Washing

See Section 2.9: Vehicle and Equipment Maintenance

See Section 2.11: Inspection and Monitoring Activities

See Section 2.12: Dust Control

See Section 2.13: Erosion and Sediment Control

3.5 GENERAL NPDES PERMIT #1200-H

Industrial activities covered under this permit include chemical manufacturing, petroleum refining, rubber manufacturing, leather tanning, stone, clay, glass, and concrete products, the primary metals industry, and steam electric power generation, including coal and hogged fuel handling sites.

The manufacturing of chemicals and related products is described by Standard Industrial Classification (SIC) Code Major Group 28. SIC Code Major Group 29 includes the petroleum refining industry, along with related activities. SIC Code Major Group 30 includes rubber and miscellaneous plastics products. Leather and leather products are covered in SIC Code Major Group 31. The production of stone, clay, glass, and concrete products are included in SIC Code Major Group 32. The primary metals industry is classified in SIC Code Major Group 33. Steam electric power generation is covered in SIC Code Major Group 49. Asphalt batch plants (SIC 2951) and concrete batch plants (SIC 3273) are covered under the 1200-A permit.

3.5.1 1200-H Potential Sources of Storm Water Contamination

Industries covered under the General Storm Water Permit #1200-H generally consist of large manufacturing areas with most of the activities taking place under cover. However, storm water can become contaminated in various ways by contact with the following:

1. raw materials, spilled and leaking significant materials, intermediate products, or by-products either found or produced on the plant site;
2. raw or intermediate products being transported to or from the site;
3. material handling areas;
4. treatment areas for process wastewaters;
5. refuse areas; and
6. shipping and receiving areas.

3.5.2 1200-H Recommended Best Management Practices

- *See Section 2.1: Outside Storage of Raw Materials, Intermediate Products, By-Products, or Finished Products*
- *See Section 2.2: Outside Container Storage and Waste Disposal*
- *See Section 2.3: Loading and Unloading Materials*
- *See Section 2.4: Emergency Spill Response and Cleanup Plans*
- *See Section 2.5: Above-Ground Tank Storage*
- *See Section 2.6: Outside Manufacturing Activity*

3.5.2 1200-H Recommended Best Management Practices continued

- *See Section 2.7: Fueling Stations*
- *See Section 2.8: Vehicle and Equipment Washing*
- *See Section 2.9: Vehicle and Equipment Maintenance*
- *See Section 2.10: Sandblasting and Painting Operations*
- *See Section 2.11: Inspection and Monitoring Activities*
- *See Section 2.13: Erosion and Sediment Control*

3.6 GENERAL NPDES PERMIT #1200-L

Industrial facilities covered under this permit are involved in light industrial activities and include metal fabrication, manufacturing of different types of equipment, and ship and boat building and repair.

The manufacturing of fabricated metals (except machinery and transportation equipment) is covered in SIC Code Major Group 34. SIC Code Major Group 35 includes the manufacture of industrial and commercial machinery and equipment and computers. The manufacturing of electronic and electrical equipment (except computer equipment) for the generation, storage, transmission, and utilization of electrical energy is covered in SIC Code 36. SIC Code Major Group 37 includes the manufacture of transportation equipment for carrying passengers and cargo by land, air, and water. The manufacture of measuring, analyzing, and controlling instruments, photographic, medical, and optical equipment, and watches and clocks is covered in SIC Code Major Group 38. Miscellaneous manufacturing industries are covered in SIC Code 39.

3.6.1 1200-L Potential Sources of Storm Water Contamination

Industries covered under the General Storm Water Permit #1200-L generally consist of large manufacturing areas with most of the activities taking place under cover. However, storm water can become contaminated by contact with the following:

1. raw materials, spilled and leaking significant materials, intermediate products, or by-products either stored or produced on the plant site;
2. the transportation of raw or intermediate products to or from the site;
3. material handling areas;
4. treatment areas for process wastewaters;
5. refuse areas; and
6. shipping and receiving areas.

3.6.2 1200-L Recommended Best Management Practices

- *See Section 2.1: Outside Storage of Raw Materials, Intermediate Products, By-Products, or Finished Products*
- *See Section 2.2: Outside Container Storage and Waste Disposal*
- *See Section 2.3: Loading and Unloading Materials*
- *See Section 2.4: Emergency Spill Response and Cleanup Plans*
- *See Section 2.5: Above-Ground Tank Storage*

3.6.2 1200-L Recommended Best Management Practices

- *See Section 2.6: Outside Manufacturing Activity*
- *See Section 2.7: Fueling Stations*
- *See Section 2.8: Vehicle and Equipment Washing*
- *See Section 2.9: Vehicle and Equipment Maintenance*
- *See Section 2.11: Inspection and Monitoring Activities*

3.7 GENERAL NPDES PERMIT #1200-M

Industrial facilities covered under this permit include mineral extraction facilities, including metal mining, coal mining, and oil and gas extraction activities.

Metal mining is covered by Standard Industrial Classification (SIC) Major Group 10. The coal mining industry is included in SIC Code 12. While coal mines currently operate in 26 states, no coal mining activities occur in Oregon. Oil and gas extraction activities are covered in SIC Code 13.

3.7.1 1200-M Potential Sources of Storm Water Contamination

According to the Federal storm water regulations, the activities designated by SIC Codes 10 through 14 are required to obtain permits if storm water discharges from the site have become contaminated by contact with any overburden, raw material, intermediate products, finished products, byproducts, or waste products located on the site of the operations. As the regulations indicate, storm water can be contaminated by contact with the following:

1. excavated raw materials or wastes placed in stockpiles;
2. process treatment systems, such as settling or tailings ponds;
3. exposed soil susceptible to erosion that surrounds the mine and process facilities due to the use of heavy machinery that destroys vegetation, or as found on haul roads;
4. the transportation of substances in open vehicles, including railcars;
5. the discharge of oils and solvents from processing equipment on the site; and
6. wash waters from equipment cleaning in the work area.

3.7.2 1200-M Recommended Best Management Practices

- *See Section 2.1: Outside Storage of Raw Materials, Intermediate Products, By-Products, or Finished Products*

Note:

Since mining operations cover large areas, covering stockpiles of excavated stone with roofed structures or tarps is both costly and impractical as a best management practices. The following should also be considered:

- A. Divert storm water runoff from outdoor storage areas. For example, construct grassed ditches around the perimeter of the storage area to collect the runoff, with further treatment (if needed) in a detention pond to remove pollutants prior to discharge to surface waters. The methods for collection and treatment of the runoff will depend on the particular pollutants detected through monitoring.

3.7.2 1200-M Recommended Best Management Practices *continued*

- *See Section 2.1: Outside Storage of Raw Materials, Intermediate Products, By-Products, or Finished Products (continued)*
 - B. Segregate the operations or processes that will produce the most significant source of pollutants on the site. Once this determination has been made, it may be possible to divert storm water runoff from these areas to prevent contamination.
 - C. Place covers over vehicles transporting materials either for processing or from the site. For example, trucks used to haul minerals from the mine to the processing area should have covered beds to prevent storm water contact with the minerals. Covering would also apply to rail cars, or other transportation options.
- *See Section 2.4: Emergency Spill Response and Cleanup Plans*
- *See Section 2.7: Fueling Stations*
- *See Section 2.8: Vehicle and Equipment Washing*
- *See Section 2.9: Vehicle and Equipment Maintenance*
- *See Section 2.11: Inspection and Maintenance of Storm Drainage Facilities*
- *See Section 2.13: Erosion and Sedimentation Control*

3.8 GENERAL NPDES PERMIT #1200-P

The pulp and paper industry, as designated in Standard Industrial Classification (SIC) Code 26, *Paper and Allied Products*, is covered under this permit, along with related activities that may be ongoing at the site, such as woodwaste landfills, chip and hogged fuel storage, truck and equipment repair, power generation, and bulk petroleum storage.

3.8.1 1200-P Potential Sources of Storm Water Contamination

Industries covered under the 1200-P generally consist of large manufacturing sites with areas for wood storage, processing, treatment, and waste disposal. Storm water at these sites can become contaminated by contact with the following:

1. raw materials, spilled or leaking significant materials, intermediate products, or by-products either found or produced on the plant site;
2. the transportation of raw materials or intermediate products to or from the site;
3. dusts and wood fines from storage and processing areas;
4. material handling areas;
5. treatment areas for process wastewaters and sludge disposal;
6. refuse areas;
7. repair activities, including painting and sandblasting;
8. bare land susceptible to erosion that may surround raw material storage areas; and
9. shipping and receiving areas.

3.8.2 1200-P Recommended Best Management Practices

- *See Section 2.1: Outside Storage of Raw Materials, Intermediate Products, By-Products, or Finished Products*
- *See Section 2.2: Outside Container Storage and Waste Disposal*
- *See Section 2.3: Loading and Unloading Materials*
- *See Section 2.4: Emergency Spill Response and Cleanup Plans*
- *See Section 2.5: Above-Ground Tank Storage*
- *See Section 2.6: Outside Manufacturing Activity*
- *See Section 2.7: Fueling Stations*

3.8.2 1200-P Recommended Best Management Practices *continued*

- *See Section 2.8: Vehicle and Equipment Washing*
- *See Section 2.9: Vehicle and Equipment Maintenance*
- *See Section 2.10: Sandblasting and Painting Operations*
- *See Section 2.11: Inspection and Monitoring Activities*
- *See Section 2.12: Dust Control*
- *See Section 2.13: Erosion Control*

3.9 GENERAL NPDES PERMIT #1200-R

This permit covers metal scrapyards, battery reclaimers, automobile wrecking yards, and salvage yards classified under Standard Industrial Classification (SIC) Code 5015, *Motor Vehicle Parts, Used*, and SIC Code 5093, *Scrap and Waste Materials*. Hazardous waste treatment, storage, and/or disposal facilities are also covered by this permit.

3.9.1 1200-R Potential Sources of Storm Water Contamination

The facilities covered under the 1200-R usually occupy large areas of land. Generally the activities ongoing at these sites, such as the separation of vehicle parts and the stockpiling of waste (scrap) materials are outdoor activities. Storm water runoff can become contaminated by contact with:

1. exposed automobile parts that may be covered with oil or grease;
2. spills of oil, grease, gasoline, antifreeze, brake fluids, or various chemicals and metals that may be found at the waste site;
3. waters from cleaning activities;
4. repair activities, including painting and sandblasting;
5. eroded soil exposed due to the activity of heavy machinery on the site;
6. waste stockpiles;
7. waste materials as they are transported to and from the site; and
8. process wastewaters from treatment activities.

3.9.2 1200-R Recommended Best Management Practices

- *See Section 2.1: Outside Storage of Raw Materials, Intermediate Products, By-Products, or Finished Products*
- *See Section 2.2: Outside Container Storage and Waste Disposal*
- *See Section 2.3: Loading and Unloading Materials*
- *See Section 2.4: Emergency Spill Response and Cleanup Plans*
- *See Section 2.5: Above-Ground Tank Storage*
- *See Section 2.6: Outside Manufacturing Activity*
- *See Section 2.7: Fueling Stations*
- *See Section 2.8: Vehicle and Equipment Washing*

3.9.2 1200-R Recommended Best Management Practices *continued*

- *See Section 2.10: Sandblasting and Painting Operations*
- *See Section 2.9: Vehicle and Equipment Maintenance*
- *See Section 2.11: Inspection and Monitoring Activities*
- *See Section 2.12: Dust Control*
- *See Section 2.13: Erosion Control*

3.10 GENERAL NPDES PERMIT #1200-S

This permit covers wastewater treatment facilities with a design flow of one million gallons per day (mgd) treating domestic sewage or sludge, treatment plants required to have an approved pretreatment program, and wastewater treatment devices or systems used in the storage, treatment, recycling, and reclamation of municipal or domestic sewage with a design flow of one mgd. Also included are lands dedicated to the disposal of sewage sludge that are located within the confines of such facilities.

3.10.1 1200-S Potential Sources of Storm Water Contamination

Domestic wastewater treatment plants usually cover large areas and consist of various treatment units and processes that may or may not be covered, storage tanks, control buildings, paved surfaces, and grassed areas. The local public works department may also locate additional facilities for vehicle maintenance on the plant site.

Storm water runoff reaching the treatment plant site can become contaminated in various ways. The primary cause of storm water contamination will probably result from contact with the following:

1. spills of materials including domestic waste, such as raw sewage, sludge, and septage; chemicals such as alum and chlorine, used in treatment processes; and industrial wastes that may have a high content in metals, acids, or other toxic substances;
2. oil and grease drippings and spilled fuel from vehicle maintenance areas;
3. leaks from containers, gaskets, and pipes; and
4. wash waters from cleaning activities.

3.10.2 1200-S Recommended Best Management Practices

- *See Section 2.1: Outside Container Storage and Waste Disposal*
- *See Section 2.3: Loading and Unloading Materials*
- *See Section 2.4: Emergency Spill Response and Cleanup Plans*
- *See Section 2.5: Above-Ground Tank Storage*
- *See Section 2.7: Fueling Stations*
- *See Section 2.8: Vehicle and Equipment Washing*
- *See Section 2.8: Vehicle and Equipment Maintenance*
- *See Section 2.11: Inspection and Monitoring Activities*

3.10.2 1200-S Recommended Best Management Practices *continued*

- *Treatment of Contaminated Storm Water*

Regarding the treatment of storm water runoff from the sewage treatment plant site, it is the Department's policy that only storm water runoff exposed to areas such as the sludge truck loadout or the grit removal containers should be routed back into the plant headworks for treatment. Prior to re-routing storm water, contact the DEQ inspector assigned to the facility to approve the change.

Connections from drainage sub-basins on the plant site into the plant headworks would be appropriate for areas where runoff is regularly contaminated or exposed to spills or overflows. Storm water runoff not contaminated in this manner should not be routed into the treatment plant. Other means of treating the contaminated runoff should be considered.

3.11 GENERAL NPDES PERMIT #1200-T

Transportation and bulk petroleum facilities having on-site vehicle maintenance shops that perform vehicle maintenance (rehabilitation, mechanical repairs, painting, fueling, and lubrication), equipment cleaning operations, or deicing operations are covered in this general permit.

These activities are classified in Standard Industrial Classification (SIC) Major Group Codes 40, *Railroad Transportation*; 41, *Local and Interurban Passenger Transport*; 42, *Trucking and Warehousing* (except 4221-25, warehousing facilities covered in the 1200-D permit); 43, *U.S. Postal Service*; 44, *Water Transportation*; 45, *Transportation by Air*; and 5171, *Petroleum Bulk Stations & Terminals*.

3.11.1 1200-T Potential Sources of Storm Water Contamination

As noted in the federal regulations (40 CFR Title 122.26), vehicle maintenance shops, equipment cleaning operations, and airport deicing operations are considered to be industrial activities related to transportation that may contaminate storm water runoff and necessitate coverage under the General Storm Water Permitting Program.

With these ongoing activities, storm water can become contaminated in various ways, including by contact with the following:

1. spilled fuel or oil and grease drippings from fueling trucks left on paved surfaces;
2. raw materials, such as stockpiles of coal, ores, limestone, sand, and gravel, that may be stored on docks or railroad yards prior to loading;
3. wash waters from cleaning activities for vehicles, vessels, containers, tanks and pipelines used in loading, or imported automobiles;
4. spilled liquids from transfer operations;
5. outdoor maintenance activities; and
6. dust and fines from dry cleaning of trucks, box cars, and cargo areas.

3.11.2 1200-T Recommended Best Management Practices

- *See Section 2.1: Outside Storage of Raw Materials, Intermediate Products, By-Products, or Finished Products*
- *See Section 2.2: Outside Container Storage and Waste Disposal*
- *See Section 2.3: Loading and Unloading Materials*
- *See Section 2.4: Emergency Spill Response and Cleanup Plans*
- *See Section 2.5: Above-Ground Tank Storage*

3.11.2 1200-T Recommended Best Management Practices continued

- *See Section 2.6: Outside Manufacturing Activity*
- *See Section 2.7: Fueling Stations*
- *See Section 2.8: Vehicle and Equipment Washing*
- *See Section 2.9: Vehicle and Equipment Maintenance*
- *See Section 2.10: Sandblasting and Painting Operations*
- *See Section 2.11: Inspection and Monitoring Activities*

3.12 GENERAL NPDES PERMIT #1200-W

This permit covers wood products manufacturing and related activities defined in Standard Industrial Classification (SIC) Codes 24, *Lumber and Wood Products (except Furniture)*, and 25, *Furniture and Fixtures*. This includes sawmills, planer mills, millwork, and production of veneer, plywood, particle board, and hardboard, along with the dry kilns, log decks, woodwaste landfills, chip and hogged fuel storage, truck and equipment repair, power generation, and other associated activities ongoing at the site. In addition, manufacturing activities are covered by the permit, including the manufacture of household, office, public building, and restaurant furniture, and office and store fixtures.

Excluded from coverage under this permit are wood preserving facilities as defined in SIC Code 2491. Facilities with this code are required to apply for individual NPDES permit for storm water discharges. Harvesting or reforestation activities are also excluded from the 1200-W. See 40 CFR 122.27 for the list of silvicultural activities exempt from NPDES permit.

3.12.1 1200-W Potential Sources of Storm Water Contamination

Industries covered under the 1200-W generally consist of large manufacturing sites with areas for wood storage, processing, treatment of wastes, and waste disposal. Storm water can become contaminated by contact with the following:

1. raw materials; spilled or leaking significant materials; by-products either used or produced on the plant site such as log decks, fractionalized wood piles, bark piles, and sawdust; dip vats for staining compounds; or adhesives;
2. the transportation of raw materials or intermediate products to or from the site;
3. sawdust and wood fines from storage and processing areas;
4. material handling areas;
5. treatment areas for process wastewaters;
6. refuse areas (waste piles);
7. bare land susceptible to erosion, including unpaved roads or areas used for material storage; and
8. shipping and receiving areas where stains, glues, bleaches, or dyes may be unloaded on the site.

3.12.2 1200-W Recommended Best Management Practices

- *See Section 2.1: Outside Storage of Raw Materials, Intermediate Products, By-Products, or Finished Products*
- *See Section 2.2: Outside Container Storage and Waste Disposal*
- *See Section 2.3: Loading and Unloading Materials*

3.12.2 1200-W Recommended Best Management Practices *continued*

- *See Section 2.4: Emergency Spill Response and Cleanup Plans*
- *See Section 2.5: Above-Ground Tank Storage*
- *See Section 2.6: Outside Manufacturing Activity*
- *See Section 2.7: Fueling Stations*
- *See Section 2.8: Vehicle and Equipment Washing*
- *See Section 2.9: Vehicle and Equipment Maintenance*
- *See Section 2.11: Inspection and Monitoring Activities*
- *See Section 2.12: Dust Control*
- *See Section 2.13: Erosion Control*

4.0 ADDITIONAL RESOURCES

4.1 DOCUMENT LIST

- Code of Federal Regulations (CFR), Title 40-Protection of Environment, Parts 122, 123, 124, and Title 33, Parts 153, 154, and 155.
* Sections of rule available from National Storm Water Hotline (703) 821-4823.
- Draft Surface Mining Reclamation Guide, Washington State Department of Natural Resources, WA, July 1992.
- Erosion Control Plans Technical Guidance Handbook, City of Portland, OR, January 1991
* Available from City of Portland (503) 796-7303.
- Erosion Control Plans Technical Guidance Handbook, Unified Sewerage Agency, OR, January 1991.
* Available from USA (503) 648-8621.
- Erosion/Sedimentation Control Plan Technical Guidance Handbook, Clackamas County, OR, August 1991.
* Available from Clackamas County (503) 655-8521.
- Stormwater Program Guidance Manual for the Puget Sound Basin, Volumes 1 & 2, Publication #92-32 and #92-33, Washington Department of Ecology, WA, July 1992.
* Available for fee from WA DOE (206) 438-7528.
- Stormwater Management Manual for the Puget Sound Basin (The Technical Manual), Publication #91-75, Washington Department of Ecology, WA, February 1992.
* Available for fee from WA DOE (206) 438-7528.
- Storm Water Management for Industrial Activities, U.S. Environmental Protection Agency (EPA), April 1992.
* Available for fee from Education Resource Information Center/Clearinghouse (614) 292-6717, order #447N. Summary available from National Storm Water Hotline (703) 821-4823.
- Storm Water Management for Construction Activities, U.S. Environmental Protection Agency (EPA), April 1992.
* Available for fee from Education Resource Information Center/Clearinghouse (614) 292-6717, order #482N. Summary available from National Storm Water Hotline (703) 821-4823.
- Water Quality Best Management Practices Manual for Commercial and Industrial Businesses, City of Seattle, WA, June 1989.

STEVEN E. LA FRANCHI

Experience

Summary:

Mr. LaFranchi is president of Environmental Science Associates, Inc. He has 15 years experience as a geologist, hydrogeologist, and environmental scientist. Recent experience consists of environmental site assessments and audits, executive summary reports detailing environmental liability of acquisitions, underground storage tank removal, decommissioning and remediation, corrective action plans, subsurface contaminant characterization, regulatory assistance, groundwater monitoring, designing groundwater monitoring wells, hazardous material RFI's, design and implementation of storm water pollution control plans, spill prevention plans, and storm water testing.

Previous work includes minerals exploration and mine production. He has managed exploration projects and completed permitting and reclamation plans for both mine and exploration projects. His background includes the design and installation of heap leach pads, and familiarity with recovery technology for gold.

Education:

M.S., Geology, University of Idaho, 1992
B.A., Geology, Chico State University, 1981

Registrations: Registered Geologist in Oregon, California, and Idaho

Licenses:

Oregon Licensed Underground Storage Tank Service Provider Soil Matrix Cleanup #11133
Oregon Licensed Underground Storage Tank Site Supervisor #2347
Oregon Licensed/Bonded Groundwater Monitoring Well Constructor #10227

Recent Project

Experience: Environmental Site Assessments for Real Estate Transactions

Performed numerous Level I and Level II Environmental Assessments including the following in Oregon: Eugene (6 sites), Creswell (1 site), Salem (3 sites), Salem (1 site), Lyons (1 site), Gates (1 site), Prineville (1 site), Albany (4 sites), Corvallis (1 site), Monroe (1 site), Grants Pass (1 site), Harrisburg (2 sites), Sutherlin (1 site), Mapleton (1 site). The environmental assessments were conducted at industrial sites, wood products facilities, sand/aggregate facilities, asphalt plants, and on commercial real estate properties. Clients confidential.

Underground Petroleum Storage Tank(s) (UST's)

Club Wholesale: Eugene, Oregon

Soil matrix cleanup of waste oil UST. Sampling and reporting as detailed in OAR 340-122-205 to 340-122-360 and OAR 340-150-001 to 340-150-150.

E.E. Wilson Refuge: Corvallis, Oregon

Delineation and sampling of contaminated UST site. Sampled and reporting conducted in accordance with OAR 340-122-205 to 340-122-360 and OAR 340-150-001 to 340-150-150.

4J School District: Eugene, Oregon

Removal and decommissioning of four (4) UST's located at Facilities Management, Willard Elementary, Coburg Elementary, and Howard Elementary Schools. Completed necessary sampling and reporting requirements to satisfy Oregon Department of Environmental Quality guidelines as defined in ORS 340-122-205 to 340-122-360, and OAR 340-150-001 to 340-150-150.

Ponderosa Subaru: Albany, Oregon

Removal and decommissioning of two (2) UST's. Conducted sampling and reporting as specified in Oregon Department of Environmental Quality regulations.

Murphy Company: Myrtle Point, Oregon

Removal and decommissioning of four (4) UST's. Completed necessary sampling and reporting. Site required plan and permit addendum for onsite soil remediation. Sampled and reporting conducted in accordance with OAR 340-122-205 to 340-122-360 and OAR 340-150-001 to 340-150-150.

Casey Industrial: Albany, Oregon

Completed removal, decommissioning, sampling and report for one (1) UST. Sampled and reporting conducted in accordance with OAR 340-122-205 to 340-122-360 and OAR 340-150-001 to 340-150-150.

Possum Auto Body: Albany, Oregon

Completed removal, decommissioning, sampling and report for one (1) UST. Sampled and reporting conducted in accordance with OAR 340-122-205 to 340-122-360 and OAR 340-150-001 to 340-150-150.

Sunnybrook Dairy: Corvallis, Oregon

Completed removal, decommissioning, and sampling for two (2) UST's. Offsite soil treatment of contaminated and permit addendum required for project. Installed four groundwater monitoring wells for site characterization and corrective action plan. Sampled and reporting conducted in accordance with OAR 340-122-205 to 340-122-360 and OAR 340-150-001 to 340-150-150.

Hart's Shell: Newport, Oregon

Spill response report and site characterization.

Murphy Company: Springfield, Oregon

Completed removal and decommissioning of three (3) UST's. Completed sampling and reporting of soil cleanup and onsite permit addendum for aeration of contaminated soil. Sampled and reporting conducted in accordance with OAR 340-122-205 to 340-122-360 and OAR 340-150-001 to 340-150-150.

Monroe Brick and Tile Company: Monroe, Oregon

Supervised removal and decommissioning of three (3) UST's. Completed soil sampling, matrix report, and onsite permit addendum for treatment of contaminated soil. Sampled and reporting conducted in accordance with OAR 340-122-205 to 340-122-360 and OAR 340-150-001 to 340-150-150.

Murphy Company: Sutherlin, Oregon

Completed removal and decommissioning of two (2) UST's. Completed sampling and reporting. Sampled and reporting conducted in accordance with OAR 340-122-205 to 340-122-360 and OAR 340-150-001 to 340-150-150.

Larry Rader: Albany, Oregon

Completed removal and decommissioning of three (3) UST's. Completed sampling and reporting. Sampled and reporting conducted in accordance with OAR 340-122-205 to 340-122-360 and OAR 340-150-001 to 340-150-150.

Springfield Forest Products: Springfield, Oregon

Completed removal and decommissioning of two (2) UST's. Completed sampling and reporting. Sampling and reporting conducted in accordance with OAR 340-122-205 to 340-122-360 and OAR 340-150-001 to 340-150-150.

Murphy Company: Florence, Oregon

Completed removal and decommissioning of one (1) UST. Completed sampling and reporting. Sampling and reporting conducted in accordance with OAR 340-122-205 to 340-122-360 and OAR 340-150-001 to 340-150-150.

Hazardous Waste and Materials Management

Northwest Industries: Albany, Oregon

Environmental geologist assisting with investigation of chlorinated solvent contamination. Development and submittal of RFI Workplan and Addendum to DEQ. Design and installation of test borings and groundwater monitoring wells. Sampling and analysis of surface soils, subsurface soils, and groundwater. Submittal of monthly progress reports to DEQ.

Hazardous Waste and Materials Management

Gonyea and Associates: Eugene, Oregon

Completed remediation of petroleum contaminated soil to facilitate real estate transfer.

Hart's Shell: Newport, Oregon

Completed spill response report for maintenance garage effluent. Characterized contaminants and proposed methodology for further investigation.

Murphy Company: Springfield, Oregon

Performed environmental review and testing for client in response to a Preliminary Assessment conducted by the EPA.

Stevens Equipment: Salem, Oregon

Assisted owner in complying with Oregon DEQ notice of noncompliance for hazardous materials storage.

Solid Waste Projects

Mals Landfill: El Centro, California

Development and sampling of groundwater for SWAT report and quarterly monitoring. Wrote executive summary report assessing the environmental liability of the landfill prior to acquisition.

Palmdale Landfill: Palmdale, California

Prepared executive summary report for use in determining environmental liability for potential acquisition.

Short Mountain Landfill: Eugene, Oregon

Conducted well development, purging, and quarterly sampling.

Groundwater Monitoring Projects

City of Carlton: Carlton, Oregon

Quarterly groundwater monitoring and reporting for sewage treatment lagoon site.

Morse Brothers: Wheatland Expansion

Groundwater modeling and analysis of impacts related to expansion of existing sand and gravel pit. Provided expert testimony at Marion County planning commission hearing.

Elements of groundwater analysis, modeling, and installation and monitoring of groundwater wells were an integral part of many of the referenced UST work sited in this resume.

Storm Water Investigation and Permitting

DOW Corning: Springfield, Oregon

NPDES sampling for storm water permitting.

Springfield Forest Products: Sweet Home, Myrtle Point, Eugene, Lebanon, Oregon

Design and implementation of storm water pollution control plan (SWPCP) and spill prevention control and countermeasures (SPCC). Sampling storm events as required by NPDES permit.

Storm Water Investigation and Permitting

Murphy Company: Swisshome Truck Shop, Oregon

Design and implementation of storm water pollution control plan (SWPCP). Sampling storm events as required by NPDES permit.

Murphy Plywood Company: Sutherlin Mill, Oregon

Design and implementation of storm water pollution control plan (SWPCP). Sampling storm events as required by NPDES permit.

C.C. Miesel: McMinnville, Oregon

Design and implementation of storm water pollution control plans for seven sites (SWPCP). Sampling storm events as required by NPDES permit.

Morse Brothers: Coffee Lake Quarry, Oregon

Design and implementation of storm water pollution control plan (SWPCP). Sampling storm events as required by NPDES permit.

Recent Training: OSHA 29 CFR Hazardous Waste Site Operations 8 hour refresher - 2/10/94, HAZMAT Solutions, Inc.
Environmental Health and Safety Law - 9/24/93, Institute for Applied Management and Law, Inc.

Memberships: National Groundwater Association

ALLEN B. MARTIN

Experience

Summary:

Mr. Martin is a consulting geologist with over 12 years experience in exploration and environmental geology. Recent experience consists of environmental site assessments and audits, executive summary reports detailing environmental liability of acquisitions, underground storage tank removal, decommissioning and remediation, supervision of monitor well installation and sampling, regulatory assistance, design and implementation of storm water pollution control plans, and storm water testing.

Previous work related to minerals exploration with experience managing all phases of exploration projects from land acquisition, through project design and budgeting, to supervision. Responsible for successfully marketing several mining joint ventures in Northeast Washington. Ongoing consulting on exploration projects with mining industry related to epithermal and metamorphic gold occurrences.

Education:

M.S., Geology, University of Idaho
B.S., Geology, Boise State University

Registrations: Oregon Registered Professional Geologist # 1474

Licenses: Oregon Underground Storage Tank Soil Matrix Cleanup Supervisor License #13290

Recent Project

Experience: Environmental Site Assessments for Real Estate Transactions

Performed Level I and Level II Environmental Assessments including the following in Oregon: Eugene (5 sites), Creswell (1 site), Lyons (1 site), Gates (1 site), Albany (1 sites), Harrisburg (2 sites), Stayton (1 site), Portland (1 site). The environmental assessments were conducted at industrial sites, wood products facilities, sand/aggravate facilities, asphalt plants, and on commercial real estate properties. Clients confidential.

Underground Petroleum Storage Tank(s) (UST's)

Larry Rader: Albany, Oregon

Assisted with removal and decommissioning of three (3) UST's. Sampling and reporting conducted in accordance with OAR 340-122-205 to 340-122-360 and OAR 340-150-001 to 340-150-150.

Stone Forest Industries: Springfield, Oregon

Supervised the removal and decommissioning of two (2) UST's. Sampling and reporting conducted in accordance with OAR 340-122-205 to 340-122-360 and OAR 340-150-001 to 340-150-150.

Fastop Grocery: Springfield, Oregon

Supervised the removal and decommissioning of two (2) UST's. Sampling and reporting conducted in accordance with OAR 340-122-205 to 340-122-360 and OAR 340-150-001 to 340-150-150.

Tantara of Oregon: Harrisburg, Oregon

Supervised the decommissioning of one (1) UST. Sampling and reporting conducted in accordance with OAR 340-122-205 to 340-122-360 and OAR 340-150-001 to 340-150-150.

Hazardous Waste and Materials Management

Gonvea and Associates: Eugene, Oregon

Completed remediation of petroleum contaminated soil to facilitate real estate transfer.

Stayton Rock Products: Stayton, Oregon

Supervised field investigation and installation of monitoring wells related to subsurface petroleum contamination.

Johannsen Cleaners: Lebanon, Oregon

Drafted Expanded Preliminary Assessment (XPA) Scope of Work Plan, supervised field work installation of three monitoring wells and wrote XPA Summary Report for ongoing investigation related to PCE contamination in soil and groundwater.

Storm Water Investigation and Permitting

Murphy Company: Swisshome Truck Shop, Oregon

Design and implementation of storm water pollution control plan (SWPCP). Sampling storm events as required by NPDES permit.

Murphy Plywood Company: Sutherlin Mill, Oregon

Design and implementation of storm water pollution control plan (SWPCP). Sampling storm events as required by NPDES permit.

C.C. Miesel: McMinnville, Oregon

Design and implementation of storm water pollution control plans for seven quarries (SWPCP). Sampling storm events as required by NPDES permit.

Morse Brothers: Coffee Lake Quarry, Oregon

Design and implementation of storm water pollution control plan (SWPCP). Sampling storm events as required by NPDES permit.

Hay & Clark: McMinnville, Oregon

Design and implementation of storm water pollution control plans for two quarries (SWPCP).

Mining Reclamation Plans

Morse Bros, Inc.: Designed mining reclamation plan for aggregate quarry in Columbia County, Oregon.

Title V Air Permits

Murphy Plywood Company: Completed regulatory requirements for Title V air permit for plywood manufacturing facility.

Recent Training: OSHA 29 CFR Hazardous Waste Site Operations 40 hour Course - 1/4/93, HAZCON, Inc.
Oregon Environmental Law Course - 10/22/93, Federal Publications, Inc.
OSHA 29 CFR Hazardous Waste Site Operations 8 hour refresher - 2/10/94, Hazmat Solutions, Inc.

Memberships: Northwest Mining Association
Society for Mining, Metallurgy, and Exploration, Inc.

Attachment H

Alternatives Analysis



April 2024
Watters Quarry Phase II Project



Purpose and Need and Project-Specific Criteria and Alternatives Analysis

Prepared for Knife River Corporation—Northwest

*Privileged and Confidential
Attorney Work Product
Prepared at Request of Counsel*

April 2024
Watters Quarry Phase II Project

Purpose and Need and Project-Specific Criteria and Alternatives Analysis

Prepared for
Knife River Corporation—Northwest
32260 Old Highway 34
Tangent, Oregon 97389

Prepared by
Anchor QEA
6720 S Macadam Avenue, Suite 300
Portland, Oregon 97219

TABLE OF CONTENTS

1	Introduction	1
2	Purpose and Need	4
2.1	Project Purpose.....	4
2.2	Project Public Need.....	4
2.2.1	Infrastructure Investment.....	7
2.2.2	Projections for Increased Aggregate Demand.....	9
2.2.3	Limited Aggregate Supplies.....	10
2.2.4	Aggregate Cost Considerations.....	10
2.2.5	The Project Meets the Identified Public Needs	11
3	Off-Site Alternatives Analysis	13
3.1	Off-Site Screening Criteria.....	13
3.1.1	Phase 1 Screening.....	13
3.1.2	Phase 2 Screening.....	27
3.1.3	Alternatives Evaluation.....	29
4	Site Selection Alternatives Summary	53
5	Identification of the Practicable Alternative.....	55
6	On-Site Alternatives Analysis.....	57
6.1	Alternative 1—No Direct Impact Alternative.....	57
6.2	Alternative 2—Preserve Wetlands A, B, C, F, G, U, Z, DD, EE, FF, OO, PP, TT, and 1-A and Ephemeral Streams B, C, D, and 1-A and Perennial Stream 1-A and Implement Compensatory Mitigation Plan.....	58
6.3	Alternative 3—Preserve Wetlands L through U, Z, AA, OO, PP, QQ, RR, SS, and XX, and Intermittent Streams B, C, and D.....	60
6.4	Alternative 4—Maximize Potential Aggregate Yield	61
7	References	63

TABLES

Table 1	Practicability Criteria	2
Table 2	ODOT Basalt Rock Quality Tests.....	6
Table 3	Phase 1 Screening Criteria.....	18
Table 4	Phase 2 Screening	30
Table 5	ODOT Region 1 Aggregate Source Product Compliance for Watters Quarry Phase II.....	33
Table 6	ODOT Region 1 Rock Core Samples Product Compliance for Watters Quarry Phase II	33
Table 7	ODOT Region 1 Aggregate Source Product Compliance for Brightwood Quarry.....	39
Table 8	ODOT Region 1 Aggregate Source Product Compliance for Angell Quarry.....	44
Table 9	ODOT Region 1 Aggregate Source Product Compliance for Farmington Quarry.....	48

FIGURES

Figure 1	Annual Aggregate Production in Portland Metro Service Area in Oregon.....	5
----------	---	---

APPENDIX

Appendix A	Alternatives Analysis Figures
Appendix B	Geology and Resource Summary Report

ABBREVIATIONS

µm	micrometer
ACP	asphaltic concrete pavement
Applicant	Knife River Corporation—Northwest
ASCE	American Society for Civil Engineers
BMP	best management practice
BPA	Bonneville Power Administration
CCZO	Columbia County Zoning Ordinance
CFR	Code of Federal Regulations
CFU	Commercial Forest Use
CO ₂ e	carbon dioxide equivalents
CRBG	Columbia River Basalt Group
Department	Oregon Department of State Lands
DEQ	Oregon Department of Environmental Quality
DNR	Washington State Department of Natural Resources
DOGAMI	Oregon Department of Geology and Mineral Industries
DSL	Oregon Department of State Lands
EFC	Exclusive Forest and Conservation
EFU	Exclusive Farm Use
FD-20	Future Development 20-acre District
GHG	greenhouse gas
Guidelines	Guidelines for Specification of Disposal Sites for Dredged or Fill Material
INST	Institutional District
IPaC	Information for Planning and Consultation
JPA	Joint Permit Application
LEDPA	Least Environmentally Damaging Practicable Alternative
MUA20	Multiple Use Agriculture
NEPA	National Environmental Policy Act
NPDES	National Pollutant Discharge Elimination System
NRCS	National Resources Conservation Service
NWI	National Wetland Inventory
OAR	Oregon Administrative Rules
OD	over-dry
ODOT	Oregon Department of Transportation
OHP	Oregon Highway Plan
ORS	Oregon Revised Statutes
P20	Passing No. 20 Sieve

PF-80	Primary Forest
PGE	Portland General Electric
RR	Rural Residential
SHPO	Oregon State Historic Preservation Office
SSD	Saturated-Surface Dry
TBR	Timber District
USACE	U.S. Army Corps of Engineers
USFWS	U.S. Fish and Wildlife Service
WOTUS	Waters of the United States

1 Introduction

In accordance with the requirements contained within the National Environmental Policy Act¹ (NEPA), the Clean Water Act Section 404(b)(1) Guidelines² (Guidelines), and Oregon's Removal-Fill Law (Oregon Revised Statutes [ORS] 196.795-990), Knife River Corporation—Northwest (Applicant) has prepared this Purpose and Need statement and Alternatives Analysis to support its Joint Permit Application (JPA) for the proposed Project. This alternatives analysis analyzes site alternatives that avoid and minimize adverse environmental effects while still achieving the purpose and need of the Project.

The NEPA requires the U.S. Army Corps of Engineers (USACE) to evaluate reasonable alternatives that would accomplish the underlying purpose and need for a proposed project. In addition to the NEPA, Section 404 of the Clean Water Act establishes a program to regulate the discharge of dredged or fill material into jurisdictional Waters of the United States (WOTUS), including certain wetlands. USACE, as the Section 404 permitting authority, must review actions that propose to impact WOTUS to determine if the action can be permitted based on a public interest review and the Guidelines. The Guidelines define the criteria to evaluate a proposed action to determine if issuance of a permit is warranted. Section 230.10 of the Guidelines provide that a permit may not be issued unless:

1. No practicable alternative to the proposed discharge exists;
2. The discharge will not violate other Federal or State laws;
3. The discharge will not cause or contribute to significant degradation; and
4. Potential adverse impacts of the discharge are minimized.

The Guidelines require applicants to demonstrate that the proposed action represents the Least Environmentally Damaging Practicable Alternative (LEDPA) that meets the purpose and need and overall goals of the project. Identification of the LEDPA is achieved by performing an alternatives analysis that evaluates the direct, secondary/indirect, and cumulative impacts to WOTUS resulting from each alternative considered. The Guidelines consider an alternative to be practicable “if it is available and capable of being done after taking into consideration cost, existing technology, and logistics in light of overall project purposes.”³ Practicability criteria for alternative evaluation are listed in Table 1. Project alternatives that are not practicable and do not meet the Project purpose and need are eliminated.

¹ 33 Code of Federal Regulations (CFR) 325, Appendix B. NEPA Implementation Procedures for the Regulatory Program.

² 40 CFR 230. Guidelines for Specification of Disposal Sites for Dredged or Fill Material.

³ 40 CFR § 230.10(a)(2).

**Table 1
Practicability Criteria**

Criteria	Definition	Basis for Criterion
Project Purpose	Meets goals and purpose of the proposed Project.	Implementation of the alternative must meet the overall goals and purpose and need of the proposed Project.
Availability	A site must be available to meet the overall project purpose and need.	Alternative sites available for purchase, lease, or license even if not actively listed for sale or lease, with the ability to allow mining within 2 years.
Logistics	Covers specific designs of a viable project and factors related to the siting, planning, and implementation of the proposed Project.	Must not require significant technical effort to overcome site conditions or extraordinary administrative or engineering controls that exceed the bounds of industry standards in terms of minimum/maximum or pass/fail.
Existing Technologies	Any current proven technology capable of implementing the proposed Project.	The alternatives examined should consider the limitations of existing technology yet incorporate the most efficient/least-impacting construction methods currently available.
Cost	Total amount of materials, supplies, equipment, and contractors. Includes direct and overhead expenses.	Cost is analyzed in the context of the overall cost of the Project compared to similar types of Projects and whether it is unreasonably expensive or exorbitant. Project cost is directly related to the economic cost to the public.

Oregon’s Removal-Fill Law, ORS 196.795–.990, requires applicants whose projects remove material from or discharge fill to wetlands or waterways to obtain a permit from the Oregon Department of State Lands (DSL or the Department). This permit is broadly referred to as a “Removal-Fill Permit.” The state typically has jurisdiction over a broader category of wetlands and waterways than does USACE. As used herein, the terms “State waters” and “State wetlands” means those waters or wetlands that are under state jurisdiction (State waters or wetlands). An alternatives analysis is also required under Oregon Administrative Rules (OAR) 141-085-0565(5) for compliance with Removal-Fill permits, which states:

The Department will issue a permit only upon the Department's determination that a fill or removal project is consistent with the protection, conservation and best use of the water resources of this state and would not unreasonably interfere with the preservation of the use of the waters of this state for navigation, fishing and public recreation. The Department will analyze a proposed Project using the criteria set forth in the determinations and considerations in [OAR 141-085-0565(3)–(4)].

Given the functional similarities between the alternatives analysis used by USACE and DSL, it is the Applicant’s intent that this alternatives analysis addresses both agencies’ requirements in support of this JPA.

This alternatives analysis is based on the scope of federal jurisdiction over WOTUS as defined by the Clean Water Rule issued on May 27, 2015. However, since that time, the definition of WOTUS has been revised based on the Supreme Court’s decision in *Sackett v. Environmental Protection Agency*, resulting in the “Revised Definition of ‘Waters of the United States;’ Conforming” rule, which was published in the Federal Register and became effective on September 8, 2023. Under the revised rule, the definition of WOTUS has been narrowed. As a result, the Applicant requested a new Approved Jurisdictional Determination from USACE on November 10, 2023, to determine the number of federal jurisdictional wetland and water areas impacted by the Project. On March 29, 2024, USACE completed the Approved Jurisdictional Determination review of the project site and issued the determination that the aquatic resources and wetlands in the review area are not WOTUS, and the proposed activity would not occur in WOTUS; therefore, a Department of Army permit is not required for the proposed work as described in this JPA.

2 Purpose and Need

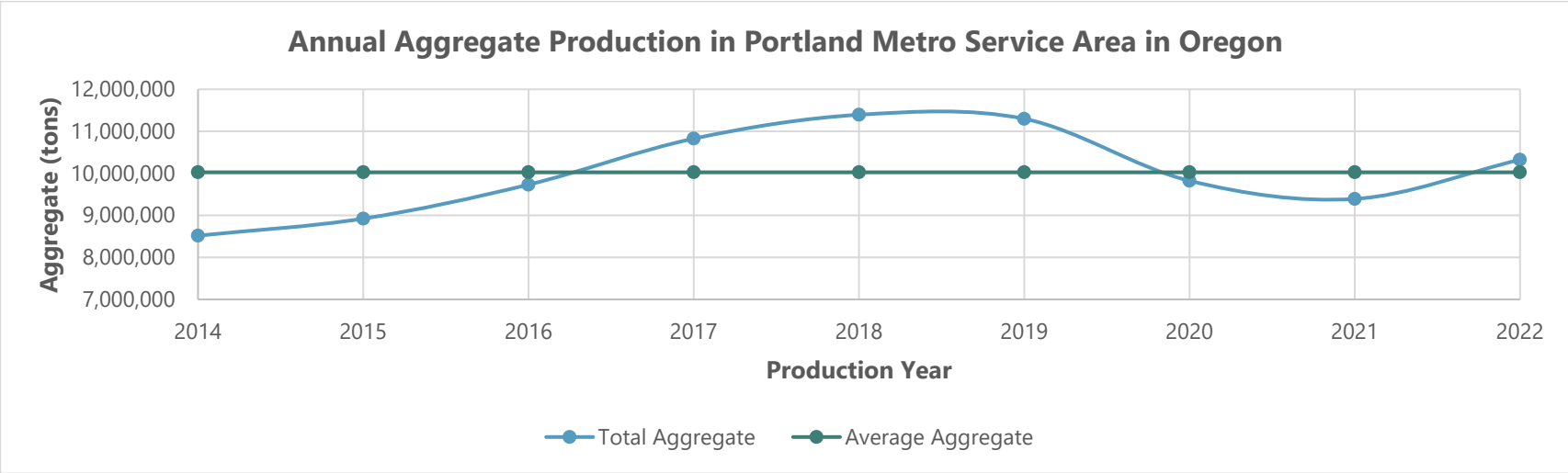
2.1 Project Purpose

The purpose of the Project is to replace the existing high-quality aggregate source at Watters Quarry with cost-competitive, high-quality, specification-grade basalt aggregate within 2 years to continue to meet existing demands and to meet increased future regional infrastructure and development requirement demands within the Portland Metropolitan Service Area consisting of Clackamas, Columbia, Hood River, Multnomah, and Washington, counties in Oregon and Clark and Cowlitz counties in Washington (Figure 10 of this JPA). The existing Watters Quarry (Phase I) provides high-quality, specification-grade basalt aggregate to meet the public needs of infrastructure projects. However, the supply of aggregate at that quarry will be exhausted within 2 years. The proposed Watters Quarry Phase II contains the same high-quality basalt as Phase I. High-quality, specification-grade crushed aggregate includes basalt suitable for use on projects that require high-grade aggregate such as substation, light rail, and heavy rail projects. Not all quarries have basalt of this quality and many are unable to meet the demand for projects requiring this type of aggregate. Watters Quarry Phase II also includes aggregate suitable for asphalt production and for standard base rock use, meeting general basalt aggregate needs.

2.2 Project Public Need

The public need driving the proposed Project is the existing demand for high-quality aggregate coupled with the increased demand related to expected population growth in the region and the future infrastructure construction, repair, and replacement needed to support that growth. Best estimates suggest the Portland Metropolitan Service Area has an annual and increasing demand for an average of 10 million tons of aggregate per year based on the 2014 to 2022 reported production amounts to Oregon Department of Geology and Mineral Industries (DOGAMI) by permittees for five Oregon counties in the Portland Metropolitan Service Area (Figure 1; DOGAMI 2024a). Reported production amounts are considered a surrogate for estimating aggregate consumption and demand. Estimating demand in the Portland Metropolitan Service Area is also based on the projected needs for aggregate to support population growth and infrastructure improvements as further described in the following sections. Additionally, many existing sources are likely nearing exhaustion because aggregate is a finite resource that is constantly being depleted as evidenced by the number of active and pending DOGAMI permit applications (DOGAMI 2024b). There will be a need to develop new aggregate sources to both make up for those lost sources and to serve the existing and future increasing demand. This means there is a public need for an annual net addition of aggregate to the market. This need is discussed in greater detail later in this section.

Figure 1



Many of the current and future infrastructure projects require specification-grade aggregate. Oregon Department of Transportation (ODOT) and other infrastructure providers use rock quality tests to determine compliance with soundness and durability specifications, such as degradation rate, abrasion, lightweight pieces, and organics and plasticity indices. Tests vary depending on the specifications for the specific aggregate product. Passing ODOT tests, such as base rock, asphalt aggregate, ballast, and so on, qualifies the on-site aggregate resource for specific construction specifications and usage capabilities. Specific basalt rock quality tests used by ODOT, railroad companies, and electrical utility companies for product compliance are summarized in Table 2.

**Table 2
ODOT Basalt Rock Quality Tests**

Test	Description
Specific Gravity (Relative Density)	An indirect measure of the strength or quality of a material. The lower the value, the weaker the aggregate. For ODOT riprap protection, a higher quality material has a specific gravity value of 2.5 or more for protecting slopes and basins (ODOT 2021a).
Absorption	A measure of the porosity and weather resistance of the internal structure of the aggregate. The higher the number, the less resistant to freeze-thaw cycles, and the lower the strength, impact resistance, and hardness. For ODOT riprap protection, a higher quality material has an adsorption value of 6% or less for protecting slopes and basins (ODOT 2021a). For railroad companies, a higher quality material has an adsorption value of 1% or less, which is difficult to find in Oregon aggregate.
Soundness (Weatherability)	Tests for presence of microcracks in the aggregate. The higher the number, the less sound (i.e., more easily weathered) the material. For railroad companies, a higher quality material has a soundness value of 5% or less, which is less than half of what is usually required in ODOT specifications (less than 12%; ODOT 2021a).
Abrasion	Determines the hardness or abrasion resistance of the aggregate from breaking down due to impact loading. The higher the number, the less resistant the material. For ODOT ACP construction, a higher quality material has an abrasion value of 30% or less (ODOT 2021a).
Oregon Degradation	Determines the degradability of the aggregates by using two parameters: passing #20 (850 µm) sieve and settlement height. The higher the numbers, the more degradation is occurring and the less resistant the material. For ODOT ACP construction, a higher quality material has a degradation value of 30% or less and a settlement height of 3 inches or less (ODOT 2021a).
Sand Equivalent	A measure of clay in the materials. The lower the number, the greater the fines in the aggregate. For ODOT ACP construction, a higher quality material has a sand equivalent value of 45 min or less (ODOT 2021a).
Resistivity ¹	Determines the conductivity of the aggregate (conductivity is the inverse of resistivity). This is the single most critical factor in electrical grounding design, which requires material with low conductivity. This test also predicts the corrosive potential of the aggregate, which requires dense aggregates with very little clays present in the passing #200 sieve (75 µm).

Test	Description
Dimethyl Sulfoxide Loss ¹	An accelerated chemical weathering test. Based on the mineralogy of the aggregates, the test determines if chemicals can break the material down. The higher the number, the more reactive the aggregate is to the chemical. A higher quality material has a Dimethyl Sulfoxide value of 12% or less.
Packing Density ¹	The lower the number, the less dense the compacted material. This indirectly requires higher specific gravity aggregates and a gradation to minimize voids.

Note:

1. Test specific to electrical utility companies.

Aggregate derived from the rock formation at the Phase I mining site and proposed Project site (Phase II) meets (ODOT) quality specifications for many products, including base rock, shoulder rock, course concrete aggregate, asphalt aggregate, and ballast rock. At current aggregate extraction rates, the existing mining area at Watters Quarry (Phase I) has enough mineable rock left for about 2 more years of operation. Knife River currently supplies approximately 500,000 tons of high-quality basalt aggregate into the Portland Metropolitan Market from the Phase I mining area on an annual basis. The loss of this multiproduct source of high-quality aggregate, will therefore, have an immediate negative impact on supplies in the Portland Metropolitan Market.

2.2.1 Infrastructure Investment

National, state, and regional economies rely on a vast physical infrastructure network made up of roads, bridges, light rail, freight rail, airports, and electrical grids. Nationally and within the Portland Metropolitan Area, many of the infrastructure systems currently in place were constructed decades ago, with the lack of improvements to these aging systems negatively impacting economic performance (Council on Foreign Relations 2021). As an example, within the United States, 1 out of 5 miles of highways and major roads and 45,000 bridges are in poor condition (White House 2021).

Recognizing the public need to rebuild our nation’s crumbling infrastructure, in 2021, the federal government passed the Infrastructure Investment and Jobs Act, P.L. 117-58 (2021; Bipartisan Infrastructure Law), which provides \$1.2 trillion in infrastructure funding over 5 years. This bill includes \$110 billion for roads, bridges, and major infrastructure projects and \$39 billion for transit and rail projects (White House 2021). This funding will be distributed to states to develop new infrastructure and improve aging infrastructure. As of May 2023, \$2.6 billion in Bipartisan Infrastructure Law funding has been allocated to Oregon with over 265 specific projects identified for funding (White House 2023). In Oregon, there are 395 bridges and over 1,287 miles of highway in poor condition. The Bipartisan Infrastructure Law funding will be used to rebuild those roads, and it includes the single largest dedicated bridge investment for significant bridges and other bridges since the construction of the interstate highway system (USDOT 2022). Based on formula funding

alone, Oregon is expected to receive approximately \$3.7 billion over 5 years in federal funding for highways and bridges.

Oregon's own infrastructure assets, many of which were built 50 to 100 years ago, face significant capacity challenges as the state's population continues to grow. The American Society of Civil Engineers (ASCE) prepared the Report Card for Oregon's Infrastructure in 2019 and issued an overall grade of "C-" for Oregon's infrastructure systems (ASCE 2019). Specifically, ASCE (2019) graded Oregon's roads, rail, and energy systems as a C or worse. A "C" grade means the following: "The infrastructure in the system or network is in fair to good condition; it shows general signs of deterioration and requires attention. Some elements exhibit significant deficiencies in conditions and functionality, with increasing vulnerability to risk."

Programmed and anticipated infrastructure improvements in the Portland Metropolitan Market Area will require large quantities of high-quality crushed aggregate. High-quality crushed aggregate is essential for the construction of roads, railroads, bridges, substations, buildings, and airports, as well as private residential, commercial, and industrial developments. Additionally, general grade aggregate is required for nearly all construction projects as a primary component of concrete and asphalt paving material and as structural fill. The aggregate at Watters Quarry would fulfill both of these needs.

The ODOT 2024-2027 Statewide Transportation Improvements Program includes a budget of approximately \$3.3 billion in federal, state, and local resources in preserving and improving Oregon's transportation infrastructure (ODOT 2023). Upcoming ODOT improvement projects that will require large quantities of specification-grade crushed aggregate for construction include the I-5 Rose Quarter Improvement Project, the Interstate 205 Corridor Widening Project, and the Oregon Route 217 Corridor Widening Project. Local improvements are also necessary to provide seismic resiliency for existing infrastructure systems that are currently at risk of damage or destruction during potential earthquakes caused by the Cascadia-Subduction Zone or other crustal faults (e.g., Portland Hills Fault). A substantial amount of specification-grade crushed aggregate material will also be needed for the I-5 Interstate Bridge Replacement Project when it enters the construction phase.

TriMet has also made annual commitments to significant physical infrastructure investments in its annual budgeting process, all of which will require large quantities of specification-grade crushed aggregate. TriMet's fiscal 2023 budget allocated \$96.5 million for light rail projects (TriMet 2023a). Its fiscal 2024 budget also heavily invests in an intensive capital project period, allotting \$328.3 million into capital improvements (TriMet 2023b). Its proposed fiscal 2025 budget continues this investment, proposing \$201 million for capital improvements (TriMet 2024). TriMet's 2025 fiscal year begins on July 1, 2024, and runs through June 30, 2025. Current TriMet infrastructure improvement projects include extension of the MAX (light rail) Red Line west to serve 10 more stations in Beaverton and Hillsboro and improve schedule reliability for the entire MAX system, as well as improvements to the

Hollywood Transit Center and expansion of the SE Park Avenue Park-and-Ride Garage (TriMet 2023c). TriMet is also continuing to pursue funding for the Southwest Corridor Project, which will extend light rail service 11 miles from downtown Portland to Tigard (TriMet 2023d). All of these projects are located within Knife River's Portland Metropolitan Service Area and will require large quantities of high-quality crushed aggregate. Other planned infrastructure projects TriMet is partnered with that need sizeable aggregate include the 82nd Avenue Bus Rapid Transit Project (Metro 2023a) and the Tualatin Valley Highway Bus Rapid Transit Project (Metro 2023b).

Portland General Electric (PGE) infrastructure improvement projects will also create significant demand for specification-grade crushed aggregate material. An example of one such upcoming project is the Tonquin Project, which involves upgrading power lines and adding a new substation in the southern portion of PGE's service area (PGE 2023). This, and similar projects designed to build a more reliable and resilient power grid, will continue to create ongoing demand for high-quality aggregate material for the foreseeable future.

2.2.2 Projections for Increased Aggregate Demand

The public need for new infrastructure and improvements to existing systems is driven in part by population growth. According to demographic forecasts provided by Oregon Metro for the period between 2010 and 2060, the population of the Portland Metropolitan Area is expected to grow to 3,534,400 people by 2060 (Metro 2016). In order to support this expected growth, new and improved public infrastructure, and private residential, commercial, and industrial development will be needed. This infrastructure cannot be constructed without adequate sources of high-quality aggregate. Put simply, reliable sources of aggregate material are crucial for the region's anticipated growth.

The most recent comprehensive applied research project on aggregates for Oregon was completed by DOGAMI in 1995 and summarized in a report entitled *Economic Analysis of Construction Aggregate Markets and the Results of Long-Term Forecasting Model for Oregon* (Whelan 1995). The main objective of the research was to produce a long-range forecast of aggregate consumption for every county in Oregon over a 50-year period (2001 to 2050). According to the 1995 report, the forecast of annual aggregate consumption for Clackamas, Columbia, Hood River, Multnomah, and Washington counties combined is over 19 million tons per year. Between these five Oregon counties, aggregate consumption is predicted to grow between 0.38% and 0.72% per year over the 2001 to 2050 research period (Whelan 1995). Furthermore, over the period from 2011 to 2050, forecasts predict that for Clackamas, Multnomah, and Washington counties, consumption will average of 17.9 million tons per year, which equals 34% of Oregon's total consumption (Whelan 1995).

This trend is evidenced by the amount of annual aggregate production in the Portland Metropolitan Area (including Clackamas, Columbia, Hood River, Multnomah, and Washington counties) based on the DOGAMI recent aggregate production records (Figure 1). From 2014 to 2022, that demand

averaged 10,026,014 tons per year (DOGAMI 2024a). Significantly, by 2019, aggregate production in these counties increased by more than 2.78 million tons, which represents a 33% increase from 2014 to 2019 (DOGAMI 2024a). However, not all producers of aggregate are required to report to DOGAMI; therefore, these production estimates are likely underestimated. Furthermore, these estimates do not include production amounts in Clark and Cowlitz counties in Washington so the total aggregate consumption and demand in the Portland Metropolitan Service Area is likely much higher.

The anticipated new industrial, commercial, residential, and public development in the Portland Metropolitan Area, coupled with the need to repair and rebuild existing facilities, indicates a continued long-term demand for high-quality aggregate.

2.2.3 Limited Aggregate Supplies

The demand for high-quality aggregate material in the Portland Metropolitan Service Area will increase with population growth and programmed and anticipated infrastructure improvements. Despite increased production of aggregate material in the Portland Metropolitan Area market in recent years, there is still a shortage of high-quality aggregate based on the current and future demands. Virgin aggregate supplies are limited by geology and competing land uses. Moreover, many of the sources currently supplying present-day demand are rapidly being depleted based on recent production amounts (Figure 1). This Project is needed to help resolve both the present and future shortage.

A 2018 study was completed of Clark County, Washington, which showed permitted aggregate reserves are estimated to be exhausted by 2039 (GeoDesign 2021). The 2018 study concluded that Clark County was facing challenges with its construction aggregate resources due to a limited and rapidly decreasing supply of permitted reserves combined with high demand for aggregate in the rapidly growing county. According to the 2018 study, aggregate consumption for Clark County in 2021 was estimated at over 1.9 million cubic yards. Aggregate reserve studies for other counties have not been identified or completed; however, known high-quality basalt deposits that are accessible and commercially viable are limited in the Portland Metropolitan Service Area.

2.2.4 Aggregate Cost Considerations

A shortage of high-quality aggregate available to meet increasing demand would result in higher costs of the aggregate, and by direct extension, the public and private projects that use aggregate. To keep those economic costs to the public down, it is important to develop known high-quality aggregate sources that are relatively inexpensive to mine and transport to market. One significant factor that contributes to the cost of mining is the amount of nonusable overburden that must be removed and managed to reach the usable rock. On the transportation side, in order to keep economic costs to the public down, mining operations must be sited close to an existing

transportation network suitable for aggregate transport, such as state highways, railways, or marine transport facilities (i.e., navigable channels). Because the cost of aggregate transport is passed onto the taxpayers and consumers for public and private projects, proximity to an efficient and existing transportation network is essential for aggregate to be provided at a cost-competitive rate.

2.2.5 The Project Meets the Identified Public Needs

Pursuant to the Guidelines, the Applicant has identified the Watters Quarry Phase II site as the LEDPA that will allow the Applicant to fulfill the Project's purpose of developing a dependable, high-quality, crushed aggregate resource to continue to provide high-quality, multiproduct, cost-competitive aggregate materials to the Portland Metropolitan Market to meet the public need. The rock formation at the Watters Quarry Phase II site constitutes an extremely high-quality aggregate resource capable of passing multiple ODOT rock quality specifications for various products. The Columbia River Basalt Group (CRBG), which underlies the Phase II site, is regionally considered to be one of the best geologic units for development of aggregate resources. However, CRBG rock quality can vary due to the rate of cooling of individual basalt flows during emplacement, the spacing and orientation of fracture and joint formation patterns, interflow sedimentary deposits in the basalt, and the degree of rock mineral alteration and post-emplacement weathering. The basalt observed at the Phase II site is more uniform and less weathered than most CRBG sources in the region. The basalt resource at the Phase II site is of very high-quality and an excellent source of multiple crushed aggregate products (NV5 2022). A summary report of the geology and resource quality at Watters Quarry is provided in Appendix B.

The high-quality basalt from the Watters Quarry Phase II site would meet the essential public needs for infrastructure investment, helping make the supply of aggregate meet demand, and keeping aggregate costs to the public down. The Phase II site would provide the needed high-quality basalt for ODOT, PGE, TriMet, freight rail projects, and electrical utility company projects. Recent projects that have used the high-quality basalt from Watters Quarry Phase I include the PGE Harborton Substation and TriMet MAX Red Line Project. Watters Quarry Phase I rock is also supplied to substation work for Evergreen, Bess Battery Storage, PGE Reedville, Bonneville Power Administration (BPA) Carlton, PGE St. Mary, PGE Orenco, and PGE Helvetia projects. In addition to the high-quality basalt, Watters Quarry Phase II would provide a large quantity of base rock to public and private development projects.

To continue supporting these and future projects, Knife River estimates the continued demand of approximately 500,000 tons or more of high-quality basalt aggregate in the Portland Metro market on an annual basis. The Phase II site is estimated to have more than 15 million cubic yards (more than 33 million tons) of marketable high-quality basalt, which would make the Project one of the largest high-quality aggregate reserves available to the Portland Metropolitan Area (NV5 2022).

Critically, among the existing quarries, the Phase II site is the only aggregate reserve available with this high-quality basalt.

The Watters Quarry Phase II site meets the identified need to keep aggregate costs to the public down because of the presence of large quantities of high-quality Columbia River basalt; proximity to road, rail, and marine transport; and the lack of thick overburden that is found mantling the resource at other local quarry locations (Evarts 2002, 2004; Wells et al. 2020). Given that the Watters Quarry Phase II site is adjacent to Watters Quarry Phase I, details about the site are documented and well understood (NV5 2022).

The Watters Quarry Phase II site is strategically located along Highway 30 (a major trucking route to the Portland Metropolitan Market) and freight rail lines. It is also close (approximately 3 miles) to Knife River's Waterview Barge Site (located at 63180 Columbia River Highway, Deer Island, Oregon 97051), which provides marine transport to Knife River's Sundial facility in Troutdale, Oregon. The Sundial facility operations include asphalt and ready-mix concrete production and aggregate material distribution.

Based on these considerations, this Project would serve the purpose and meet the needs of the Portland Metropolitan Area for years to come.

The Applicant also analyzed potential alternative sites and designs for their ability to meet the purpose and need. This analysis is presented in the following sections. Exhibits supporting this analysis are provided in Figures 1 through 14 in Appendix A.

3 Off-Site Alternatives Analysis

The Applicant evaluated other potential mining sites within Columbia County, Washington County, Multnomah County, Clackamas County, and Hood River County in Oregon, and Clark County and Cowlitz County in Washington.

3.1 Off-Site Screening Criteria

3.1.1 Phase 1 Screening

Phase 1 screening was performed to identify potentially practicable alternatives to evaluate further in Phase 2 screening. Alternatives that did not meet the five Phase 1 Screening Criteria were dismissed from further evaluation. The screening criteria incorporate the Guidelines and have been analyzed for alternatives that are potentially practicable after considering availability, economic cost to the public, existing technology, and logistics in light of overall Project purposes. The Applicant used the following Phase 1 criteria to identify practicable alternatives that were then advanced for evaluation under the Phase 2 Screening Criteria:

1. **Have the ability to supply high-quality aggregate rock to the Portland Metropolitan Service Area.** The geographic extent of the Portland Metropolitan Service Area was determined by the Applicant's existing service area and ability to provide high-quality aggregate resources to the Portland Metropolitan Area as depicted in Figure 10 of this JPA. All potential alternative sites meeting these criteria and located within Columbia County, Washington County, Multnomah County, Clackamas County, and Hood River County in Oregon, and Clark County and Cowlitz County in Washington that can serve a significant portion of the Portland Metropolitan Service Area were included in this analysis. This criterion also includes the ability to provide a long-term local and steady source of high-quality crushed aggregate to the Portland Metropolitan Market. Sites with the ability to serve only a limited portion of the Portland Metropolitan Area were eliminated from this analysis, primarily because these sites are geographically distant from the identified service area and unable to serve projects throughout the identified service area. That is, the farther aggregate is hauled from a quarry, the greater transportation, cost, and greenhouse gas (GHG) impacts are. Therefore, the mine site must generally be within the service area to fulfill the purpose and need.
2. **Have a commercially profitable, decades long and steady quantity of high-quality crushed aggregate resource that meets infrastructure project needs and related aggregate quality specifications.** An alternative site must be able to supply sufficient quantities of high-quality crushed aggregate within 2 years to continue to meet existing and to meet increased future regional infrastructure and development requirement demands within the Portland Metropolitan Service Area. This specification-grade basalt aggregate must meet the requirements for railroad ballast and asphalt pavement crushed rock needed for substations and

light rail projects and other long-term projects identified in the purpose and need. Use of multiple sites with less than a decade of mine life would be impracticable due to added costs of mobilization, movement of operations, cumulative impacts, and multiple permitting timelines, which would make the sites nonprofitable. Also, an alternative site must have the ability to produce high-quality crushed aggregate that meets ODOT quality specifications for the following products: course concrete aggregate, asphalt aggregate, and base rock. A crushed aggregate resource means rock with fracture surfaces on all sides. Crushing round rock from a gravel resource (as opposed to a basalt resource) produces rock fragments with partially rounded sides and decreases the rock's ability to interlock during application. As a result, alternatives processing a gravel resource do not meet this criterion. Sites were identified as possessing high-quality crushed aggregate based on geologic mapping and local expert knowledge.

The Applicant is targeting sites capable of providing at least 15 million cubic yards or 33 million tons of high-quality crushed rock over the life of a quarry to keep mining and public costs down. This target was developed based on population growth projections and the need for new and updated infrastructure to support future population growth and seismic resiliency needs.

3. **Ability to allow mining within two years.** For the purposes of this alternatives evaluation, sites that would not allow for mining within 2 years are considered to be impracticable for quarry development because they would not meet the purpose and need of the project. Mining permits in Oregon are issued by the DOGAMI, and reclamation permits in Washington are issued by the Washington State Department of Natural Resources (DNR). In Washington, sites must have a DNR reclamation permit to conduct mining activity. Sites with existing mining permits are zoned and designated to allow surface mining and processing. Sites that would require a new conditional use permit are also not being considered within this analysis, as the process for achieving conditional use approval from local jurisdictions is complex and contingent on the satisfaction of land use standards and local comprehensive plan policies, as well as consistency with the standards of the unpermitted site's zoning district. Achieving local land use approval entails added costs and additional time that would make an unpermitted alternative impracticable to meet the purpose and need of the Project.
4. **Have designated land use zoning that allows mining and processing.** The Applicant is not considering alternatives that would need to go through local land use approval processes, such as a zone change, as these non-Project actions often take several years to complete prior to the Applicant even being able to begin the permitting process for a site-specific development project. This would not meet the purpose and need of having permits to begin mining within 2 years. Therefore, the overall costs, logistical challenges, and added time involved would make an alternative inadequate to meet the purpose and need of the project.
5. **Be reasonably available to the Applicant.** The Applicant does not consider a site owned by a competitor to be a practicable alternative unless a site is available for sale or long-term lease

and is not currently mined. Any sites currently being mined are included in the current supply, which needs to be increased to meet the existing and future needs of the public for high-quality aggregate. Sites owned by public entities are not available to the Applicant.

The Applicant identified all potentially practicable alternatives by evaluating the DOGAMI database of permitted mines in Columbia, Washington, Multnomah, Clackamas, and Hood River County in Oregon, and the DNR database of permitted mines in Cowlitz and Clark County Washington. A total of 110 alternatives were considered in Phase 1. These alternatives are shown in Appendix A, Figure 1. Table 3 summarizes the Phase 1 screening results for each of these alternatives. The alternatives presented in Table 3 were taken directly from the DOGAMI and DNR databases and include some sites that are not actively being mined or are depleted of resources. Notes on the availability of aggregate resources at these sites are provided in Table 3. An alternative must meet all five screening criteria to be carried forward to Phase 2.

As shown in Table 3, a total of 82 out of 110 alternative sites met the criterion for their ability to serve part of the Portland Metropolitan Service Area (Figure 10 of this JPA; Criterion 1). Of these sites, 42 met Criterion 2 for having sufficient quantities of high-quality crushed aggregate that meets specifications established by ODOT and Criterion 3 for having an existing mining permit. Of these 42 sites, 40 met Criterion 4 for having designated land use zoning that allows mining and processing within 2 years. Four of the 40 remaining alternatives were also reasonably available to the Applicant and not being mined (i.e., not in the current supply pool; Criterion 5). These four alternatives meet all five of the screening criteria and were carried into the Phase 2 screening process (Section 3.1.2).

These alternatives consist of the following:

1. Alternative 9: Watters Quarry
2. Alternative 34: Brightwood Quarry
3. Alternative 53: Angell Quarry
4. Alternative 57: Farmington Quarry

Smaller properties and parcels were excluded from the evaluation due to the extensive transactional challenges inherent to purchasing multiple small parcels that may have variable ownership interests in order to create a contiguous site large enough to support a profitable mining operation. In addition to transactional challenges, small parcels alone are rarely viable because of the large minimum-acreage requirements that local zoning ordinances impose on sites designated, or to be designated, for surface mining. Small parcels also lack the resource quantity necessary to develop a long-term steady supply of high-quality aggregate in accordance with the Project's purpose and need. It is not viable to develop multiple mines on smaller parcels to achieve the purpose and need of this Project because of the intensity of site-specific and cumulative impacts that developing multiple mines would entail, in addition to the logistical and cost challenges inherent to establishing and operating multiple small mining operations.

The Applicant is not considering greenfield sites because these locations are not zoned for resource extraction and the extensive studies required to rezone a greenfield site alone can take 5 to 10 years or more and therefore does not meet the timeline in the purpose and need. To further expand on why these sites take too long to meet the purpose and need, the following explanation is provided.

To pursue a greenfield site, a market study must first be conducted to estimate how the existing market is currently being served by other existing sites and determine the needed quantity of reserves at the greenfield site. Other factors that would have to be evaluated include the maximum travel distance to bring material to market, the existing geology units and resource type, as well as any land use zoning that may affect potential mining operations. Each process and associated timeline to pursue a greenfield site are as follows:

1. Secure an option to lease the site with the landowner, which can take 6 months to reach an agreement, pending the outcome of the following processes.
2. Conduct Environmental Phase I and II evaluations, if necessary. These evaluations can take 2 to 6 months, depending on whether a Phase II subsurface investigation is needed.
3. Drill property to confirm resource and quality, which can take 6 to 8 months depending on the driller's schedule.
4. Test materials to confirm quality. This can take 2 months depending on laboratory availability.
5. Conduct land use studies, including traffic, noise, wetland, archaeology, and groundwater; prepare mining and reclamation plan, conduct floodplain review, soils survey, and biological study. These studies can take 2 years to complete.
6. Submit land use application to the local agency. This can take 6 months for review prior to submitting for public comment.
7. Allow for public hearing and accept public comments for the proposal. The public participation process takes at least 2 months.
8. Respond to public comments, which can take 2 months.
9. Finalize Land Use Decision with possible conditions. It can take 2 months to receive a decision.
10. The project then could begin but would take more than 4.5 years to develop into a fully functional mine.
11. Overall, it would take 6 to 7 years or longer to pursue a greenfield site, assuming the application is accepted and not deemed incomplete.

The cost, logistical challenges, and time required to obtain all necessary local, state, and federal entitlements eliminate the greenfield sites as practicable to meet the Project's purpose and need. Additionally, changing a land use from a greenfield to mining is often met with resistance by adjacent landowners who have purchased their property assuming that land use would not change. For this reason, these timelines are often extended per public request and decisions could be

appealed, extending the timeline even more. Lawsuits and regulatory challenges brought by interested citizens and special interest groups could further delay permitting by years.

Furthermore, the Applicant has extensive knowledge and expertise operating within the Portland Metropolitan Service Area and has conducted a review of the Service Area for any potentially viable greenfield sites that meet the Project's purpose and need. During this review, the Applicant has been unable to identify any greenfield sites where high-quality aggregate resources have been identified, much less any large resource-bearing sites that are designated a Significant Aggregate Resource under Oregon Statewide Planning Goal 5 *and* that possess the appropriate zoning and entitlements to make surface mining viable within the purpose and need timeline. In the absence of any identified greenfield sites that can meet the Project's purpose and need, and considering the cost, logistics, and time necessary to complete extensive studies and acquire all necessary local, state, and federal permits and associated land entitlements, greenfield sites would not meet the purpose and need and therefore, are not evaluated in this alternatives analysis.

**Table 3
Phase 1 Screening Criteria**

Site Owner; Site Name	1. Have the ability to supply local rock to the Portland Metropolitan Service Area	2. Have a commercially viable decades long and steady quantity of high-quality crushed aggregate resource	3. Have an existing permit for mining	4. Have designated land use zoning that allows mining and processing	5. Be readily available (within 2 years) to the Applicant	Carried to Phase 2?
Clackamas County, Oregon						
1. Cadman Materials Inc.; Canby Pit	✓		✓	✓		No
2. Cadman Materials Inc.; Canby Reserve Expansion	✓		✓	✓		No
3. Canby Sand & Gravel Company; Canby Sand & Gravel	✓		✓	✓		No
4. Colvin Sand, Inc.; Colvin Sand	✓		✓	✓		No
5. Eagle Creek Rock Products LLC; Eagle Creek Gravel	✓		✓	✓		No
6. Estacada Rock Products, Inc.; Estacada Rock	✓		✓	✓		No
7. Gary A. Wilmes; Wilmes Rock Products	✓		✓	✓		No
8. Internat'l Union of Operating Engineers Local 701; Molalla Sand & Gravel	✓		✓	✓		No
9. Knife River Corp. NW - Tangent; Watters Quarry & Mill	✓	✓	✓	✓	✓	Yes
10. Jonas Land LLC; Anderson Quarry				✓		No
11. Judy Yeo; Marks Quarry			✓	✓		No

Site Owner; Site Name	1. Have the ability to supply local rock to the Portland Metropolitan Service Area	2. Have a commercially viable decades long and steady quantity of high-quality crushed aggregate resource	3. Have an existing permit for mining	4. Have designated land use zoning that allows mining and processing	5. Be readily available (within 2 years) to the Applicant	Carried to Phase 2?
12. L. Roy Bonner; Damascus Sand & Gravel	✓		✓	✓		No
13. Lonnie & Patricia Endicott; Mira Monte	✓		✓	✓		No
14. Lowell E. Patton; Carver Stone	✓		✓			No
15. Lowell E. Patton; Stone Tong			✓	✓		No
16. Northwest Aggregates Co.; Wilmes Sand & Gravel	✓		✓	✓		No
17. Northwest Sand & Gravel, Inc.; Northwest Sand & Gravel ¹				✓		No
18. ODOT Portland - Jeff Jones; Brightwood Quarry			✓	✓		No
19. ODOT Portland - Jeff Jones; Tamarack Quarry	✓	✓	✓	✓		No
20. Portland General Electric Company - Lindsay Smith; River Mill Dam Gravel Pit				✓		No
21. Tonquin Holdings, LLC; Tonquin Quarry (fka Poole Quarry Property)	✓					No
Columbia County, Oregon						
22. Columbia County Public Works; Apiary Pit	✓	✓	✓	✓		No

Site Owner; Site Name	1. Have the ability to supply local rock to the Portland Metropolitan Service Area	2. Have a commercially viable decades long and steady quantity of high-quality crushed aggregate resource	3. Have an existing permit for mining	4. Have designated land use zoning that allows mining and processing	5. Be readily available (within 2 years) to the Applicant	Carried to Phase 2?
23. Columbia County Road Department; Ross Quarry	✓	✓	✓	✓		No
24. Columbia Rock Company LLC; Goble Pit	✓	✓	✓	✓		No
25. Eagle Star Rock Products LLC; Hankey Road ²	✓	✓	✓	✓		No
26. Ed Bergman; Bergman Pit	✓	✓	✓	✓		No
27. Kerr Contractors, Inc.; Goble Quarry	✓	✓	✓	✓		No
28. Kerr Contractors, Inc.; Neer City Pit	✓	✓	✓	✓		No
29. Knife River Corp. NW - Tangent; Deer Island Site	✓		✓	✓		No
30. Knife River Corp. NW - Tangent; Hoffman Site	✓		✓	✓		No
31. Knife River Corp. NW - Tangent; Oak Ranch Quarry 1			✓	✓		No
32. Knife River Corp. NW - Tangent; Oak Ranch Quarry 2			✓	✓		No
33. Knife River Corp. NW - Tangent; Reichhold Site	✓		✓	✓		No
34. Jim Turin & Sons Inc.; Brightwood Quarry	✓	✓	✓	✓	✓	Yes
35. Kynsi Construction Inc.; Graham Pit	✓	✓	✓	✓		No

Site Owner; Site Name	1. Have the ability to supply local rock to the Portland Metropolitan Service Area	2. Have a commercially viable decades long and steady quantity of high-quality crushed aggregate resource	3. Have an existing permit for mining	4. Have designated land use zoning that allows mining and processing	5. Be readily available (within 2 years) to the Applicant	Carried to Phase 2?
36. Northwest Aggregates Co. - Robert Hostettler; Bates-Roth	✓		✓	✓		No
37. Northwest Aggregates Co. - Robert Hostettler; Bible College Property	✓		✓	✓		No
38. Northwest Aggregates Co. - Robert Hostettler; Fort James	✓		✓	✓		No
39. Northwest Aggregates Co. - Robert Hostettler; Pit C	✓		✓	✓		No
40. Northwest Aggregates Co. - Robert Hostettler; Pit D	✓		✓	✓		No
41. Northwest Aggregates Co. - Robert Hostettler; Pit F	✓		✓	✓		No
42. Northwest Aggregates Co. - Robert Hostettler; Santosh Pit A & B	✓		✓	✓		No
43. ODOT Salem; Oak Ranch Creek Quarry			✓	✓		No
44. Steven D. Gerttula; Mayger Quarry	✓	✓	✓	✓		No
45. Tide Creek Rock Company - John Allen Peterson; Tide Creek Rock	✓	✓	✓	✓		No
Hood River County, Oregon						
46. Farmers Irrigation District; Kingsley Reservoir Expansion Borrow Area				✓		No
47. Hood River County Road Department; Dee Pit	✓	✓	✓	✓		No

Site Owner; Site Name	1. Have the ability to supply local rock to the Portland Metropolitan Service Area	2. Have a commercially viable decades long and steady quantity of high-quality crushed aggregate resource	3. Have an existing permit for mining	4. Have designated land use zoning that allows mining and processing	5. Be readily available (within 2 years) to the Applicant	Carried to Phase 2?
48. Hood River County Road Department; Old Dalles Pit	✓	✓	✓	✓		No
49. Hood River Sand, Gravel & Ready Mix, Inc.; Cascade Locks Pit				✓		No
50. Hood River Sand, Gravel & Ready Mix, Inc.; Hood River Rock Pit	✓	✓	✓			No
51. J. Arlie Bryant, Inc.; Dukes Valley Quarry	✓	✓	✓	✓		No
52. Port of Cascade Locks; Industrial Park			✓	✓		No
Multnomah County, Oregon						
53. Knife River Corp. NW - Tangent; Angell Quarry	✓	✓	✓	✓	✓	Yes
54. LJ Smith Logging - Leroy W. Smith; Howard Canyon Pit				✓		No
55. Mutual Materials Co.; Columbia Plant				✓		No
56. ODOT Portland - Jeff Jones; Krueger Quarry		✓	✓	✓		No
Washington County, Oregon						
57. Baker Rock Crushing Co.; Farmington Quarry ³	✓	✓	✓	✓	✓	Yes
58. C.C. Meisel Co., Inc.; Town Quarry ¹			✓			No
59. David A. Peterson; Peterson Rock Pit	✓	✓	✓	✓		No

Site Owner; Site Name	1. Have the ability to supply local rock to the Portland Metropolitan Service Area	2. Have a commercially viable decades long and steady quantity of high-quality crushed aggregate resource	3. Have an existing permit for mining	4. Have designated land use zoning that allows mining and processing	5. Be readily available (within 2 years) to the Applicant	Carried to Phase 2?
60. Farmington Mobile Crushing LLC; Parkin Quarry	✓	✓	✓	✓		No
61. Gary Pendergrass; Lite Rock	✓	✓	✓	✓		No
62. James A. Smejkal; Bailey Quarry				✓		No
63. Kerr Contractors, Inc.; Compton-Stiller Quarry	✓	✓	✓	✓		No
64. Knife River Corp. NW - Tangent; Coffee Lake Quarry ⁴		✓	✓	✓	✓	No
65. Knife River Corp. NW - Tangent; Tonquin Quarry ¹			✓			No
66. Mead Family Trust - Stephen Mead; Mead Pit			✓	✓		No
67. Northfork Excavating Inc.; Tonquin Road Pit ¹			✓	✓		No
68. ODOT Salem; Luck Quarry	✓	✓	✓	✓		No
69. ODOT Salem; Strassel Quarry (Detroit)	✓	✓	✓	✓		No
70. Port of Tillamook Bay; Cochran Mill Site	✓	✓	✓	✓		No
71. Six Corners Land Investments, Oregon, Ltd.	✓	✓	✓	✓		No
72. Tigard Sand & Gravel LLC - Roger Metcalf; Tonquin Quarry	✓	✓	✓	✓		No

Site Owner; Site Name	1. Have the ability to supply local rock to the Portland Metropolitan Service Area	2. Have a commercially viable decades long and steady quantity of high-quality crushed aggregate resource	3. Have an existing permit for mining	4. Have designated land use zoning that allows mining and processing	5. Be readily available (within 2 years) to the Applicant	Carried to Phase 2?
73. Undesignated Land, Inc. - Peter Adams; Aloha Quarry ¹				✓		No
74. Westside Rock-Hayden Quarry, LLC; Hayden Quarry	✓	✓	✓	✓		No
75. Willow Creek LLC; Gaston Quarry	✓	✓	✓	✓		No
Clark County, Washington						
76. Cadman Materials Inc; Lewisville Pit (CEMEX)	✓		✓	✓		No
77. Canyon Creek Partners LLC; Washougal River Pit	✓		✓	✓		No
78. Clark County Public Works; Finn Hill	✓		✓	✓		No
79. Clark County Public Works; Maple Pit Quarry G-9	✓		✓	✓		No
80. Clark County Public Works; Whatley Pit G-43	✓		✓	✓		No
81. CTC Section 30 LLC; English Pit	✓		✓	✓		No
82. DNR SW PRO 532; Spotted Deer/Randall Kirk	✓		✓	✓		No
83. Fazio Bros Sand Co Inc; Fazio Pit	✓		✓	✓		No
84. HP Inc; SE 1st St Facility			✓	✓		No
85. J L Storedahl & Sons Inc; Daybreak	✓		✓	✓		No

Site Owner; Site Name	1. Have the ability to supply local rock to the Portland Metropolitan Service Area	2. Have a commercially viable decades long and steady quantity of high-quality crushed aggregate resource	3. Have an existing permit for mining	4. Have designated land use zoning that allows mining and processing	5. Be readily available (within 2 years) to the Applicant	Carried to Phase 2?
86. J L Storedahl & Sons Inc; Woodland Pit			✓	✓		No
87. J L Storedahl & Sons Inc; Yacolt Mt. Quarry	✓	✓	✓	✓		No
88. Keystone Contracting Inc; Circle	✓		✓	✓		No
89. Pacific Realty Associates; Reebbs/Parr			✓	✓		No
90. Pebble Creek Farms LTD; Twin Peaks			✓	✓		No
91. Tower Rock Products Inc; Tebo	✓		✓			No
92. Tower Rock Products Inc; Livingston Mt. Quarry		✓	✓	✓		No
93. Tower Rock Products Inc; Livingston	✓	✓	✓	✓		No
94. Waldow Family Ent Inc; Courtney Rock Quarry	✓	✓	✓	✓		No
95. ZP#5, LLC; Washougal	✓		✓	✓		No
Cowlitz County, Washington						
96. 3 B'S Land & Gravel LLC; Mt Solo	✓	✓	✓	✓		No
97. Derosier Trucking Inc; Coweeman	✓	✓	✓	✓		No
98. Derosier Trucking Inc; Fiorito	✓		✓	✓		No
99. Derosier Trucking Inc; Pleasant Hill	✓		✓	✓		No
100. High Level LLC; Kelso Quarry	✓	✓	✓	✓		No
101. J L Storedahl & Sons Inc; Anchor Point	✓		✓	✓		No

Site Owner; Site Name	1. Have the ability to supply local rock to the Portland Metropolitan Service Area	2. Have a commercially viable decades long and steady quantity of high-quality crushed aggregate resource	3. Have an existing permit for mining	4. Have designated land use zoning that allows mining and processing	5. Be readily available (within 2 years) to the Applicant	Carried to Phase 2?
102. J L Storedahl & Sons Inc; Carrols Pit		✓	✓	✓		No
103. J L Storedahl & Sons Inc; Coal Creek	✓	✓	✓	✓		No
104. Keystone Contracting Inc; Gobel	✓	✓	✓			No
105. Lloyd & Netta Groat; Kalama Quarry	✓	✓	✓	✓		No
106. Nutter Corporation; DD Marquardt	✓		✓	✓		No
107. Poly Rec Development Inc; Hakkinen Pit	✓	✓	✓	✓		No
108. Port of Kalama; S Port Industrial	✓		✓	✓		No
109. Westside Quarry Inc; Westside Quarry	✓	✓	✓	✓		No
110. Weyerhaeuser Company; Alder Bluff Quarry	✓	✓	✓	✓		No

Notes:

Blank cells indicate that a considered alternative did not meet a screening criterion.

1. These alternatives have no remaining aggregate resources available.

2. This alternative includes Jillson Pit from the DOGAMI database. Jillson Pit is part of the Hankey Road mine, and for purposes of this analysis, they are considered one alternative.

3. This alternative includes Koehler Quarry from the DOGAMI database. Koehler Quarry is part of Farmington Quarry, and for purposes of this analysis, they are considered one alternative.

4. The Coffee Lake Quarry contains less than 5 years of resources available for mining; therefore, this alternative is not being carried forward into the Phase 2 Screening Criteria due to its low inventory.

3.1.2 Phase 2 Screening

The Applicant used the following criteria to further screen each of the four potentially practicable alternative Project sites that passed through the Phase 1 screening process:

- 1. Have direct access to existing multiple modes of transportation.** A viable alternative must have direct access to multiple modes of transportation so that the Applicant may efficiently transport aggregate to the Portland Metropolitan Service Area with minimal impact on the regional transportation system and GHG emissions. Public and private construction projects are increasingly focused on minimizing GHG emissions related to the transportation of mined rock that generates GHG emissions. In many settings, transportation occurs exclusively by truck, which results in a greater number of individual loads traveling over public roads. By contrast, where a mine site is located in close proximity to a railroad or barge facility, the transportation-related GHG emissions can be reduced significantly by moving much greater volumes of mined rock in a single trip. By using efficient transportation systems and siting mining operations close to market, it is possible to also reduce degradation of the physical infrastructure used to transport material, primarily by reducing the amount of truck trips and miles traveled on local roadways. This in turn, reduces the GHG emissions associated with replacing that existing infrastructure. The Applicant estimates transporting 350,000 tons of aggregate by barge or rail each year; therefore, per-trip and per-year estimates were evaluated in a GHG emissions analysis for each Phase 2 alternative (Bridgewater Group 2022). The U.S. Environmental Protection Agency provides GHG emission factors for various fuel combustion sources and for multiple GHG pollutants with corresponding global warming potentials. For diesel mobile combustion, carbon dioxide equivalents (CO_{2e}) were calculated by multiplying emission factors and the global warming potentials obtained from the U.S. Environmental Protection Agency in order to calculate CO_{2e} emissions for each Phase 2 alternative (Bridgewater Group 2022).
- 2. Have a maximum average overburden depth of 20 feet.** An alternative must have a maximum average overburden depth of 20 feet or less. Public and private construction projects are also increasingly focused on minimizing GHG emissions related to construction materials. For example, in January 2022, the City of Portland's Low Carbon Concrete Initiative's requirements went into effect (City of Portland 2019). The initiative requires the City of Portland to reduce the carbon footprint of concrete used on City projects. The mining activity that generates the most GHG emissions is the removal and management of overburden. Therefore, sites with a relatively shallow overburden depth generate lower GHG emissions than those where significant volumes of overburden must be removed and either managed on site or transported off site. Unmarketable soil and weathered rock that overlie the resource, referred to as "overburden," must be removed in order to access the underlying marketable aggregate material, but it often must also be stored on site for use in site reclamation (NV5 2022). Significant time and resources are devoted to managing the overburden that is a byproduct of the mining process

and nonmarketable aggregate. Equipment is required to handle overburden, including bulldozers, loaders, and haul trucks, which use diesel as a fuel source. Furthermore, sloped sites cause difficulty for overburden management, which can prevent access to the underlying resource. Typically, overburden must be less than 20 feet deep for a mining operation to economically manage moving and storing the material. The estimated cost to remove and manage overburden is approximately \$3.50 per cubic yard. Management of overburden in excess of 20 feet becomes cost-prohibitive due the additional material that must be removed and managed during mining operations.

Additionally, overburden management is a major factor in GHG emissions. The equipment required to remove and manage overburden uses diesel fuel, which emits carbon dioxide, methane, and nitrous oxide, all of which are considered GHGs (Bridgewater Group 2022). The benefits of selecting a resource with shallow overburden are reflected in minimization of environmental impacts (e.g., stockpile management and erosion potential, GHG emissions from additional excavation), limitations on logistical challenges, and the need to acquire additional equipment for extensive overburden management, and by extension, the overall cost-effectiveness of the Project.

3. **Be located away from conflicting land uses.** A viable alternative must be able to minimize land use conflicts and operate within all defined mining setbacks as established by the zoning ordinances of the local land use authority.
4. **Minimize potential adverse social and economic impacts on adjacent communities.** An alternative must have minimal noise and dust impacts on nearby communities. Alternatives must also have a minimal impact on the local transportation network.
5. **Minimize potential adverse environmental impacts.** This criterion includes minimizing disturbance to sensitive species and habitats including forestlands; protected, rare, and sensitive wildlife and plant species; and wetlands and other water resources. It also includes minimizing GHG emissions from site preparation and transportation of aggregate materials and minimizing impacts from noise and dust.
6. **Minimize potential adverse impacts on cultural resources.** This criterion includes minimizing disturbance to any prehistoric or historic remains or indicators of past human activities, including artifacts, sites, structures, landscapes, and objects of importance to a culture or community for scientific, traditional, religious, or other reasons.

The Phase 2 screening process for the remaining four alternatives is presented in the following sections.

3.1.3 Alternatives Evaluation

Of the 115 alternative sites analyzed under Phase I, only four alternative sites met all five of the Phase 1 Screening Criteria and were carried into the Phase 2 screening process (Appendix A, Figure 1). These alternatives consist of the following:

1. Phase 1 Alternative 9: Watters Quarry
2. Phase 1 Alternative 34: Brightwood Quarry
3. Phase 1 Alternative 53: Angell Quarry
4. Phase 1 Alternative 57: Farmington Quarry

These alternatives were evaluated using the Phase 2 Screening Criteria in the following sections and summarized in Table 4.

Table 4
Phase 2 Screening

Site Owner; Site Name	1. Have direct access to existing multiple modes of transportation	2. Have a maximum average overburden depth of 20 feet	3. Be located away from conflicting land uses	4. Minimize potential adverse social and economic impacts on adjacent communities	5. Minimize potential adverse environmental impacts	6. Minimize potential adverse impacts on cultural resources
Columbia County, Oregon						
(1) Knife River Corp. NW - Tangent; Watters Quarry & Mill	✓	✓	✓	✓	✓	✓
Clackamas County, Oregon						
(2) Jim Turin & Sons Inc.; Brightwood Quarry		✓	✓	✓		✓
Multnomah County, Oregon						
(3) Knife River Corp. NW - Tangent; Angell Quarry	✓		✓	✓		✓
Washington County, Oregon						
(4) Baker Rock Crushing Co.; Farmington Quarry ¹		✓				

Notes:

Blank cells indicate that a considered alternative did not meet a screening criterion.

1. This alternative includes Koehler Quarry from the DOGAMI database. Koehler Quarry is part of Farmington Quarry, and for purposes of this analysis, they are considered one alternative.

3.1.3.1 Watters Quarry Phase II

Watters Quarry Phase II (Alternative 9 in Table 3) represents the LEDPA for the purposes of this alternatives analysis as outlined in the following text. Watters Quarry Phase II is located adjacent to and southwest of the Applicant's Watters Quarry Phase I mining site, just north of St. Helens in Columbia County, Oregon (Figure 1 of this JPA). Watters Quarry Phase II includes portions of tax lots 51W32DD00100, 51W330000300, 51W320001600, and 51W330000400 (Figure 3 of this JPA). A portion of tax lot 51W32DD00100 was included in the originally approved mining area and is now within the St. Helens Urban Growth Boundary. Tax lot 51W330000300 is zoned as Surface Mining, and tax lots 51W32DD00100, 51W320001600, and 51W330000400 are zoned as Primary Forest (PF-80; Appendix A, Figure 2). Columbia County's PF-80 zoning classification allows for the mining and processing of aggregate and mineral resources as a conditional use subject to Planning Commission review and approval. Columbia County Zoning Ordinance (CCZO) 505.2. The Applicant holds a Columbia County Conditional Use Permit (Attachment B to this JPA), a DOGAMI operating permit (Permit ID No. 05-0018; Attachment C to this JPA) and an Oregon Department of Environmental Quality (DEQ) 1200-A Stormwater Permit (Permit No. 108484) for Watters Quarry Phase II.

The Watters Quarry Phase II Project site would allow Knife River to continue to provide a long-term, local, and steady continuous supply of high-quality basalt aggregate from the site to maintain market demand and serve growing market demand. This Project will also benefit the local and regional community by providing mining, construction, and service-related jobs. The Phase II Project site has already been identified as an important aggregate resource. It was added to the County Goal 5 Inventory in 1995 as a Significant Aggregate Resource based on the quality and extent of the basalt formation at the site (Columbia County Planning Commission 1995). The State of Oregon recognizes quarries that meet certain criteria, primarily related to quality and quantity of rock, as significant mineral and aggregate resources. Such quarries and associated activities for extraction and processing of the rock are eligible for protection under the State's Planning Goal 5 – "Open Spaces, Scenic and Historic Resources and Natural Resources." Protection means that the local comprehensive plan and code supports long-term mining operations on the site.

Watters Quarry Phase II is approximately 70 acres in size and contains more than 15 million cubic yards or 33 million tons of high-quality basalt deposits that would meet market demand for more than 50 years. The Watters Quarry Phase I mine site is identified as a commercial aggregate source on ODOT's TransGIS mapper, which provides information on their material source network (ODOT 2021b). ODOT identifies the highest material use of aggregate from the site as being asphalt concrete and Portland cement concrete. The basalt located at Watters Quarry Phase II is part of the same basalt formation that the Applicant currently mines at the Watters Quarry Phase I site. A recent resource evaluation was completed for the Phase II site with the results of that evaluation summarized in a 2022 report entitled *Revised Mine Resource Evaluation Report – Phase 2 Mine Area*

(NV5 2022). This report confirmed that the basalt resource present at the Watters Quarry Phase II site is of the same aggregate quality as the Phase I mine site. A mine resource evaluation for the Phase II site was initially conducted in 1992, and the results were summarized in a report by Cascade Earth Sciences, Ltd. The Cascade Earth Sciences report reviewed site characteristics and the results of on-site drilling and laboratory testing of collected samples. The laboratory testing indicates that the resource is of high-quality and meets ODOT specifications. The NV5 2022 report provides additional subsurface information and the results of aggregate quality testing. This report demonstrates that the resource value of the Phase 2 mine area is capable of producing aggregates that meet specifications for a wide variety of applications, including ODOT transportation materials and other specialized products. Based on laboratory testing of bulk rock samples, rock cores, and crushed products from the site, Watters Quarry Phase II is capable of producing a variety of aggregate products that meet ODOT acceptance criteria (see Table 2 for a description of ODOT basalt rock quality tests and baseline specifications) including for Portland cement concrete, ACP, riprap, and chip (Tables 5 and 6).

**Table 5
ODOT Region 1 Aggregate Source Product Compliance for Watters Quarry Phase II**

Test	Material Source No. 05-015-1 for 5/8" #4 ACP Product Compliance	Material Source No. 05-015-1 for Riprap Product Compliance	Material Source No. 05-015-1 for 3/8" #4 Chip Product Compliance
ODOT Laboratory No.	06-000226	23-001020	21-000385
Laboratory Date	2/28/2006	6/1/2023	3/23/2021
Abrasion (% loss)	10.90%		8.10%
Oregon Degradation	P20: 11.0% Height: 0.2 inch	P20: 17.4% Height: 0.7 inch	P20: 0.2% Height: 0.2 inch
Specific Gravity (OD)	2.77	2.73	2.77
Specific Gravity (SSD)	2.81	2.76	2.81
Apparent Specific Gravity	2.89	2.79	2.88
Absorption	1.50%	0.60%	1.40%
Soundness	0%	1.10%	1.00%

Note:
Source: Knife River

**Table 6
ODOT Region 1 Rock Core Samples Product Compliance for Watters Quarry Phase II**

Test	Boring B-1 (15 feet to 61.5 feet)	Boring B-2 (96.8 feet to 147 feet)	Boring B-3 (169 feet to 215 feet)
ODOT Laboratory No.	W-1	W-2	W-3
Laboratory Date	2/28/2006	6/1/2023	3/23/2021
Abrasion (% loss)	14.0%	13.0%	17.0%
Oregon Degradation	P20: 16.1% Height: 0.5 inch	P20: 13.4% Height: 0.4 inch	P20: 12.6% Height: 0.4 inch
Specific Gravity (OD)	2.791	2.77	2.722
Specific Gravity (SSD)	2.829	2.812	2.758
Apparent Specific Gravity	2.900	2.878	2.822
Absorption	1.30%	1.30%	1.30%
Soundness	0.90%		

The following subsections evaluate Watters Quarry Phase II under the Phase 2 Screening Criteria.

3.1.3.1.1 Criterion 1: Have Direct Access to Multiple Modes of Transportation

Watters Quarry Phase II provides access to U.S. Highway 30 (Appendix A, Figure 3). U.S. Highway 30 is an OHP designated freight route (ODOT 2021b). It is located directly adjacent to the Applicant’s Watters Quarry Phase I mining site and is proximate to its existing mining infrastructure including its

power supply, rock crushing plant, and truck scale, which would allow Watters Quarry Phase II to make continued use of this existing on-site infrastructure and eliminating the need to build redundant improvements to begin mining operations within the Watters Quarry Phase II mining area. The frequency of Phase II aggregate transportation would follow the same frequency of Phase I aggregate transportation (approximately 500,000 tons/year), including the relative associated costs.

Watters Quarry Phase II has direct access to multiple modes of transportation to deliver aggregate to the Portland Metropolitan Service Area. As noted, U.S. Highway 30 is adjacent to the site and provides access for haul trucks. The Portland and Western Railroad line has a rail siding approximately 3 miles north that would allow material to be transported from the site to market via freight rail (Appendix A, Figure 3). It is also approximately 3 miles from the Applicant's Waterview Barge Site (located at 63180 Columbia River Hwy, Deer Island, Oregon 97051), which currently provides the Applicant access to waterborne barge transport up the Columbia River to the Applicant's Sundial facility in Troutdale, Oregon. Phase I aggregate is currently trucked to the Waterview Barge Site. Knife River does not currently have an agreement to use the rail siding at the Waterview Barge Site. However, if this mode of transportation is needed to deliver Watters Quarry aggregate, Knife River would work with the Portland and Western Railroad to coordinate use of this existing rail siding.

Fuel consumption and GHG emissions were evaluated for Watters Quarry Phase II (Bridgewater Group 2022). Considering the removal and management of overburden material and interflow deposits (reject rock), the total CO_{2e} emissions for on-site operations are estimated to be 2,740 metric tons (Bridgewater Group 2022). Additionally, transporting material by rail and barge will result in reduced GHG emissions as compared with transport by truck. Utilizing the Applicant's 7,000-ton barge, one trip from the Waterview Barge Site to the Portland Metropolitan Service Area represents the equivalent of 233 truck trips on the public roadway system. Averaging 2 hours per truck trip to transport material to market would result in approximately 4,334 gallons of diesel fuel usage. This would generate approximately 45 tons of total CO_{2e} emissions to transport the equivalent amount of aggregate as one barge trip (Bridgewater Group 2022). One barge trip uses approximately 2,706 gallons of diesel, which generates approximately 28 tons of total CO_{2e} emissions (Bridgewater Group 2022). Using these estimates, transporting material by barge would result in approximately 38% less total CO_{2e} emissions compared to transporting material by truck.

The Applicant also owns nineteen 100-ton railcars, which could be used to transport 1,900 tons of aggregate material per rail trip. One rail shipment from Watters Quarry Phase II can replace 63 haul trucks from traveling into the Portland Metropolitan Service Area (averaging 2 hours per truck trip), which results in reduced impacts to the public roadway system and fuel reduction benefits. Utilizing rail transport for a single 1,900-ton shipment of material consumes an estimated 957 gallons of diesel, while transporting the same 1,900 tons via haul trucks consumes 1,172 gallons of diesel

(Bridgewater Group 2022). Using these estimates, total CO₂e emissions are reduced from 12 metric tons for transporting 1,900 tons of material via truck down to less than 10 metric tons per single railway shipment. Assuming 184 rail shipments per year (derived from 350,000 tons per year), the annual reduction through railway transport is approximately 419 metric tons of CO₂e when compared to trucking.

This alternative has direct access to road, rail, and barge transportation options that will allow the Applicant to reduce GHG emissions and impacts to the public roadway system, while also allowing the Applicant to make use of flexible transportation options in response to market conditions and demand. Watters Quarry Phase II meets Criterion 1.

3.1.3.1.2 Criterion 2: Have a Maximum Average Overburden Depth of 20 Feet

A soil thickness evaluation performed by Anchor QEA shows that a majority (approximately 85%) of the Watters Quarry Phase II site has between 0 and 3 feet of soil (overburden) overlaying the basaltic resource (bedrock). Most of the remaining area has between 3 and 5 feet of overburden, with only approximately 2.7 acres (4% of the site) having soil depths exceeding 5 feet. Bedrock is exposed over much of the site, which is a consequence of the scouring that occurred during the Missoula floods. A mine resource evaluation completed for the site shows that all borings encountered less than 1 foot of overburden, consisting of brown silt with coarser fragments of weathered basalt (NV5 2022). The total overburden volume was estimated at 100,000 cubic yards. Assuming an average cost of \$3.50 per cubic yard to remove and manage overburden, the estimated cost for Watters Quarry Phase II site would be approximately \$400,911, which equates to approximately \$5,727 per acre and is not cost-prohibitive. Considering the removal and management of overburden material and interburden deposits (reject rock), total diesel usage is estimated to be approximately 242,428 gallons generating approximately 2,740 metric tons of total CO₂e emissions (Bridgewater Group 2022).

The overburden depth at the Watters Quarry Phase II averages less than 20 feet, meaning that overburden management activities are not cost-prohibitive and would result in relatively low total CO₂e emissions. Watters Quarry Phase II meets Criterion 2.

3.1.3.1.3 Criterion 3: Be Located Away from Conflicting Land Uses

Watters Quarry Phase II is located near existing residential and commercial properties (Appendix A, Figure 2); however, with the required setbacks for the mining operation, it is unlikely to adversely affect any of those areas, especially because the site is located adjacent to an established active aggregate mine. Residences located along the west side and south sides of the Project site are closest to potential impacts emanating from mining activity within the Watters Quarry Phase II mining area. Residential lots within Elk Ridge Phase 6 and future phases of the Elk Ridge subdivision, located to the west of Watters Quarry Phase II, contain a plat notice that the parcel is located within the impact area of a State of Oregon Goal 5 mining site and that mining activity may result in

adverse impacts, including dust, noise, and other mining-related impacts. The Applicant's Columbia County Conditional Use Permit (Attachment B to this JPA) and a DOGAMI operating permit (Permit ID No. 05 0018; Attachment C to this JPA) are also available to the public.

The mining area has been refined to provide a larger setback in places than is required by the CCZO (200 feet from a residence or residential zoning district). This larger setback is located to the west and south of the proposed mine and will consist of a mosaic of upland areas, existing wetlands and created wetland mitigation areas (Appendix D to this JPA). A minimum of 900 feet would separate the mining operations boundary from residentially zoned parcels and other non-residentially zoned parcels in the vicinity of Watters Quarry Phase II site and will serve to minimize any off-site impacts.

The potential for land use conflicts at the Watters Quarry Phase II site is limited. This alternative is located an adequate distance from conflicting sensitive land uses and is well buffered, and the Applicant will employ best management practices (BMPs) to limit fugitive dust, noise, and other impacts inherent to aggregate mining and production. This alternative meets Criterion 3.

3.1.3.1.4 Criterion 4: Minimize Potential Adverse Social and Economic Impacts on Adjacent Communities

There are several residential and commercial properties near Watters Quarry Phase II that may be susceptible to social and environmental disturbances because of mining activity. However, the mining area within Watters Quarry Phase II is set back from adjacent properties, screened and buffered to the west and south, and the Applicant will be employing BMPs to limit off-site impacts of mining activity. Moreover, main aggregate processing activities for Watters Quarry Phase II will occur within the existing processing and staging area of Watters Quarry Phase I. The rock crushing plant at Watters Quarry Phase I has a DEQ Air Contaminant Discharge Permit, which regulates not only emissions from this source but any fugitive dust from haul roads on site. The plant has water spray nozzles at the crushers and transfer points to minimize particulate matter in the air. All the haul roads on site are gravel, and water is used if necessary to keep any fugitive dust down. The Watters Quarry Phase I facility has a paved exit area to prevent materials being tracked out. If track-out becomes an issue, a street sweeper is used to clean up the roadway surface at the entrance to U.S. Highway 30. Mining operations would occur between the hours of 7:00 a.m. and 6:00 p.m., as required by the CCZO 1044.5 to minimize noise impacts. Phased mining within Watters Quarry Phase II will further minimize noise by focusing noise-generating activities to certain locations within the mining area at given times.

Access to Watters Quarry Phase II would be provided by existing access roads through the Watters Quarry Phase I mining site, so disruption of the existing transportation system is not likely to occur. During initial phases of the Project, haul truck access between Watters Quarry Phase I and Phase II would be provided at an at-grade crossing of Liberty Hill Road with traffic control. This crossing

would be needed to transport aggregate from the mining areas of Watters Quarry Phase II to the processing equipment at Watters Quarry Phase I. Once mining in Watters Quarry Phase II reaches an adequate depth, a box culvert or similar structure would be installed so that mining vehicles and equipment could access the expansion area below grade, eliminating the Liberty Hill Road at-grade crossing. Any movement of Liberty Hill Road would be temporary to facilitate installation of the below-grade crossing.

This alternative will minimize socioeconomic impacts on neighboring properties and the surrounding community. This alternative meets Criterion 4.

3.1.3.1.5 Criterion 5: Minimize Potential Adverse Environmental Impacts

Watters Quarry Phase II is covered by a patchwork of forested, scrub-shrub, and open herbaceous-dominated areas (Figure 4 of this JPA). The majority of the site was selectively logged within the past decade. Remaining tree species on the site include Douglas fir (*Pseudotsuga menziesii*), Oregon white oak (*Quercus garryana*), big leaf maple (*Acer macrophyllum*), sitka spruce (*Picea sitchensis*), western hemlock (*Tsuga heterophylla*), black cottonwood (*Populus trichocarpa*), red alder (*Alnus rubra*), and Oregon ash (*Fraxinus latifolia*), with mixed scrub-shrub and herbaceous vegetation in the understory.

No mapped wetlands or streams are shown for Watters Quarry Phase II on the U.S. Fish and Wildlife Service (USFWS) National Wetland Inventory (NWI; USFWS 2022), and the National Resources Conservation Service (NRCS) Web Soil Survey indicates that the majority of the site is underlain by nonhydric soils with limited hydric inclusions (NRCS 2022). However, a recent wetland delineation conducted by Pacific Habitat Services, Inc. (PHS 2019, 2020a, 2020b), and Anchor QEA (Anchor QEA 2021), identified a total of 38 wetlands, one perennial drainage, four intermittent drainages, and four ephemeral drainages on the Project site (Figures 5 and 6a through 6e of this JPA). No perennial streams are present in the proposed mining area. Those wetlands and streams either drain to the Columbia River or Milton Creek through various off-site drainages, excavated ditches, and pipes. The wetlands and streams are distributed across the site such that total avoidance of them would not be possible by an aggregate mining operation. However, the Phase II design has been refined to avoid numerous wetlands on the north, west, and south sides of the mining site (7.14 total wetland acres). In addition to avoidance and minimization measures, impacts to wetlands would be reduced through on-site wetland mitigation.

No federally protected species are known to be on the Project site. No fish-bearing streams are present on the Project site. Stormwater from the Project would discharge to Milton Creek and the Columbia River. Spring, summer, and fall Chinook, coho, chum, pink, and sockeye salmon; summer and winter steelhead; bull trout; white and green sturgeon; and Pacific lamprey are mapped as present in the Columbia River (Streamnet 2024). Fall Chinook and coho salmon, winter steelhead, and Pacific lamprey are mapped as present in Milton Creek (Streamnet 2024). With implementation of

BMPs required by the National Pollutant Discharge Elimination System permit, stormwater impacts on fish would be negligible.

Given the history of forest practices at the Project site, mature forest stands are not present. This alternative would be required to develop stormwater controls implementing BMPs as required under the Applicant's DEQ water quality certification. Stormwater controls would be designed to minimize stormwater impacts in receiving waters; therefore, they would have a negligible effect on aquatic species in receiving waters.

This alternative will minimize adverse environmental impacts and meets Criterion 5.

3.1.3.1.6 Criterion 6: Minimize Potential Adverse Impacts on Cultural Resources

A cultural resource survey was conducted on Watters Quarry Phase II by Archaeological Investigations Northwest, Inc., in March 2020 (AINW 2020). Multiple archaeological isolates were identified on the site during the investigation. All but one of those resources were determined to be ineligible for listing in the National Register of Historic Places. The remaining resource was not evaluated for eligibility because it is located in an area that would be avoided by the proposed Project.

This alternative would avoid all known cultural resources and meets Criterion 6.

3.1.3.2 Brightwood Quarry

Brightwood Quarry (Alternative 1 in Table 4) is an existing basalt mine owned by the Applicant, located in unincorporated Clackamas County, Oregon (Appendix A, Figure 1). It is located north of Highway 26 near the unincorporated community of Brightwood, off of East Boulder Creek Lane. The quarry is located on tax lot 26E24 00100 (Appendix A, Figure 4). The quarry is zoned Timber District (TBR; Appendix A, Figure 5). Under Clackamas County Zoning and Development Ordinance 406.04(B), the TBR zoning designation allows for mining and processing of subsurface resources as a conditional use subject to review and approval by the Hearings Officer. Mining operations at Brightwood Quarry were established prior to the development of state land use laws, and operations continue at the site as a lawfully established nonconforming use. The quarry has an existing DOGAMI operating permit (Permit ID No. 03-0028) and a DEQ 1200-A Stormwater Permit (Permit 107561). This alternative allows for expansion of the existing quarry into adjacent lands to the northwest through a conditional use permit. Land use review by Clackamas County and an amendment to the DOGAMI permit would be required for the quarry to expand. The Brightwood Quarry site has a mining area of approximately 63 acres that will last more than 20 years at the current production rate. Brightwood Quarry is considered to have large quantities of minable high-quality crushed aggregate resources.

The aggregate resource at Brightwood Quarry consists of basaltic andesite flows and andesitic tuffs erupted from volcanoes of the Cascade Range overlying basaltic flows of the CRBG. The CRBG is the primary resource unit and typically yields high-quality aggregate unless the rock is strongly weathered. The overlying Cascadian volcanics generally have lower quality, primarily due to being more susceptible to weathering, but andesite flows may produce good quality rock. Blending of the various flow-rock types within the quarry can compensate for lesser quality flows but increased handling may result in increased GHG emissions and higher production cost per unit volume. Aggregate from this alternative can be used to produce high-grade asphalt. Based on laboratory testing of bulk rock samples, rock cores, and crushed products from the site, Brightwood Quarry is capable of producing a variety of aggregate products that meet ODOT acceptance criteria (see Table 2 for a description of ODOT basalt rock quality tests and baseline specifications) including for asphaltic concrete pavement (ACP) and riprap (Table 7). ODOT identifies the highest material use of aggregate from the site as being asphalt concrete (ODOT 2021b).

Table 7
ODOT Region 1 Aggregate Source Product Compliance for Brightwood Quarry

Test	Material Source No. 03-077-1 for 1/2" #4 ACP Product Compliance	Material Source No. 03-077-1 for Riprap Product Compliance
ODOT Laboratory No.	18-002410	22-001675
Laboratory Date	8/13/2018	8/18/2022
Abrasion (% loss)	12.4%	
Oregon Degradation	P20: 10.3% / Height: 0.3 inch	
Specific Gravity (OD)	2.74	2.76
Specific Gravity (SSD)	2.79	2.79
Apparent Specific Gravity	2.88	2.86
Absorption	1.20%	
Soundness	1.40%	

Note:
Source: Knife River

The following subsections evaluate Brightwood Quarry under the Phase 2 Screening Criteria.

3.1.3.2.1 Criterion 1: Have Direct Access to Multiple Modes of Transportation

Access to and from Brightwood Quarry is provided exclusively by East Boulder Creek Lane (Appendix A, Figure 6). The quarry is located approximately 1.8 miles from U.S. Highway 26, an Oregon Highway Plan (OHP) Freight Route (ODOT 2021b), which provides transportation access from the quarry to the market area. Access within the site would be achieved by utilizing existing unpaved haul roads. As the quarry is expanded, new access roads would be required within the footprint of the mining area.

No freight rail, barge, or other modes of transportation are available to haul aggregate materials from Brightwood Quarry to market. As such, aggregate material can only be hauled by truck, which results in greater GHG emissions compared to rail and barge and higher production cost per unit volume. Due to the lack of multimodal transportation options, 233 haul trucks would be necessary to transport the equivalent amount of material as one 7,000-ton barge. One 30-ton haul truck uses 9.3 gallons of diesel per hour (Bridgewater Group 2022). Averaging 2 hours per truck trip to transport material into Gresham, which is the nearest point of access into the Portland Metropolitan Service Area, the total diesel usage to transport 7,000 tons of aggregate via 233 truck trips would result in approximately 4,334 gallons of diesel usage. This diesel usage generates approximately 45 metric tons of total CO_{2e} emissions (Bridgewater Group 2022).

Brightwood Quarry does not have access to multiple modes of transportation and therefore, does not meet Criterion 1.

3.1.3.2.2 Criterion 2: Have a Maximum Average Overburden Depth of 20 Feet

The bedrock at Brightwood Quarry is overlain by colluvial soil and by thicker accumulations of landslide deposits along the western side of the site. This overburden material consists of weathered, clay-to boulder-sized materials without resource value. The overburden depth at the Brightwood Quarry has an average thickness of approximately 8 feet and the site has an estimated 1.5 million cubic yards of overburden and weathered basalt reject rock that must be stored and managed on site. Assuming an average cost of \$3.50 per cubic yard to remove and manage overburden and reject material, the estimated total cost for overburden management at Brightwood Quarry would be less than \$5.3 million, which equates to approximately \$83,000 per acre and is not cost-prohibitive. Considering the removal and management of overburden material, total diesel usage is estimated to be approximately 350,267 gallons, which generates approximately 3,609 metric tons of total CO_{2e} emissions (Bridgewater Group 2022).

The overburden depth at the Brightwood Quarry site averages less than 20 feet, meaning that overburden management activities are not cost-prohibitive and would result in relatively low total CO_{2e} emissions. Brightwood Quarry meets Criterion 2.

3.1.3.2.3 Criterion 3: Be Located Away from Conflicting Land Uses

Land surrounding the Brightwood Quarry is zoned as TBR and is primarily undeveloped forestland managed by the federal Bureau of Land Management for recreation use. The Sandy Ridge Trail System, a mountain bike network, is located approximately 1,000 feet to the west of the site. According to the Bureau of Land Management National Data online mapper, lands immediately to the east and to the northwest of the Brightwood Quarry site are designated as Areas of Critical Environmental Concern. Areas of Critical Environmental Concern-designated lands are areas where special management attention is needed to protect important historical, cultural, and scenic values,

or fish and wildlife or other natural resources. The unincorporated community of Brightwood is located south of the quarry, and the closest residence is located approximately 1,500 feet to the southwest. The required setbacks for the mining operation would minimize any adverse effects on nearby properties. This site allows for expansion into adjacent lands to the northwest of the existing quarry. However, this would require land use review by Clackamas County and an amendment to the DOGAMI permit.

With local land use approvals and DOGAMI permit amendment, Brightwood Quarry meets Criterion 3.

3.1.3.2.4 Criterion 4: Minimize Potential Adverse Social and Economic Impacts on Adjacent Communities

Residential properties and recreational uses are located near Brightwood Quarry and may be susceptible to environmental disturbances from noise and dust of mining operations. The rock crushing plant at Brightwood Quarry has a DEQ Air Contaminant Discharge Permit, which regulates emissions from this source and any fugitive dust from haul roads on site. The plant has water spray nozzles at the crushers and transfer points to minimize particulate matter in the air. All on-site haul roads are gravel, and water is used if necessary to keep any fugitive dust down. Mining operations would comply with DEQ noise control standards, as required by the Clackamas County Zoning and Development Ordinance (Section 708.05).

Access to Brightwood Quarry is achieved by existing roads and the local existing transportation system would not be disrupted by this alternative. Additional gravel access roads may be required within the quarry to access the mining area to the northwest if mining operations are expanded to that area.

This alternative would minimize impacts on socioeconomics and neighboring communities and meets Criterion 4.

3.1.3.2.5 Criterion 5: Minimize Potential Adverse Environmental Impacts

No field surveys of plants, fish, and wildlife use have been completed for the Brightwood Quarry site, nor were they required by the existing DOGAMI operating permit. As such, the Applicant reviewed publicly available online databases and mapping information to assess whether Brightwood Quarry's meets this criterion. Land along the perimeter of the active Brightwood Quarry is primarily mixed coniferous and deciduous forest situated on steep terrain. The USFWS's NWI online mapper shows several drainages (streams) along the perimeter of the existing quarry (USFWS 2022). A wetland delineation has not been performed for the Brightwood Quarry site; however, the NRCS Web Soil Survey indicates that the entire site as well as adjacent surrounding lands are underlain by non-hydric soils with limited hydric inclusions (NRCS 2022).

North Boulder Creek flows along the northern and western outside perimeters of the site and turns south around the extent of the existing quarry. Stormwater from the quarry ultimately discharges to North Boulder Creek, which drains into the Sandy River approximately 0.35 mile downstream (south) of the quarry. The Oregon Explorer online map viewer (OSU 2022) indicates that essential salmonid habitat and fish presence occurs in North Boulder Creek, including spring-run Chinook salmon (*Oncorhynchus tshawytscha*), coho salmon (*O. kisutch*), and winter-run steelhead (*O. mykiss*). These species, along with fall-run Chinook salmon, summer steelhead, and Pacific lamprey (*Entosphenus tridentatus*), are also present in the Sandy River at the mouth of North Boulder Creek. With implementation of BMPs required by the NPDES permit, including on-site settling ponds to control water flow and settle out any suspended solids prior to discharge, potential impacts to fish species in North Boulder Creek and the Sandy River would be negligible.

The USFWS Information for Planning and Consultation (IPaC) database lists one species that may be present and potentially affected by activities in this location: Northern spotted owl (*Strix occidentalis caurina*), which is listed as federally threatened. The closest designated critical habitat is approximately 5 miles to the northwest of the existing quarry. Mature forest stands could be present in the adjacent lands and expansion of mining operations to the northwest would require removal of those stands if present. If suitable spotted owl nesting, roosting, and foraging habitat is adjacent to the Brightwood Quarry, it is fringe habitat close to land disturbance and is unlikely to support resident territorial pairs. While continued quarry operations and expansion may result in noise that may affect sensitive species on adjacent lands, noise impacts to sensitive species are unlikely in these areas due to ongoing quarry operations at the site, the presence of BPA transmission lines, and other land disturbances in the area.

While this alternative would minimize adverse impacts to sensitive species and habitat, it would result in relatively high GHG emissions from transportation of aggregate material (See Criterion 3 discussion); therefore, it does not meet Criterion 5.

3.1.3.2.6 Criterion 6: Minimize Potential Adverse Impacts on Cultural Resources

The Oregon State Historic Preservation Office (SHPO) online mapper does not show any historic resources or archaeological sites at or near the Brightwood Quarry. The closest mapped sites include houses and cabins in the community of Brightwood, located downslope from the site.

This alternative would not have adverse impacts on cultural resources and meets Criterion 6.

3.1.3.3 Angell Quarry

Angell Quarry (Alternative 53 in Table 3) is an existing quarry owned and operated by the Applicant. The Project site, located in unincorporated Multnomah County, Oregon (Appendix A, Figure 1). It is located on the southwest side of Highway 30 near the Sauvie Island Bridge and includes tax parcels 2N1W28B -01700, 2N1W29 -00400, 2N1W29 -00500, 2N1W29 -00600, and 2N1W29 -00700

(Appendix A, Figure 7). All of these tax lots are zoned as Commercial Forest Use (CFU)-1 (Appendix A, Figure 8) and designated with Multnomah County's Protected Aggregate and Mineral Extraction Area overlay. The CFU-1 zoning designation allows for mining and processing of aggregate and other mineral or subsurface resources as a conditional use subject to Multnomah County Planning Commission review and approval (Multnomah County Code [MCC 11.15.2048(A)(3)]). Angell Quarry was issued a conditional use permit to perform mining operations in 1996 (Permit No. CU 6-96). The quarry also has an existing DOGAMI operating permit (Permit ID No. 26-0019) and a DEQ 1200-A Stormwater Permit (Permit No. 100111). The site was determined to be a significant Goal 5 Mineral and Aggregate resource by Multnomah County. Aggregate processing is currently accomplished through use of an on-site crushing plant. The site has a minable area of approximately 175 acres that would last more than 50 years at the current production rate.

The aggregate resource at Angell Quarry consists of the Grand Ronde Basalt of the CRBG. Grand Ronde flows typically yield high-quality aggregate unless the rock is strongly weathered, which often occurs near flow contacts. Several flow contacts occur in the quarry that include vesicular zones, pillow basalt/palagonite with a high degree of alteration, and clay accumulations between flows. Therefore, the quality of the aggregate at Angell Quarry is not consistent, and the flow contact materials do not have resource value. Based on recent laboratory testing of crushed products from the site (Table 8), Angell Quarry is capable of producing base rock and riprap products that meet ODOT acceptance criteria (see Table 2 for a description of ODOT basalt rock quality tests and baseline specifications). The site has also produced limited amounts of aggregate for ACP in the past. Since then, the aggregate resource out of the Angell Quarry has failed to meet ODOT specifications for ACP rock. ODOT identifies the highest material uses of aggregate from the site as being asphalt concrete, wall backfill, base rock, and riprap (ODOT 2021b).

This alternative does not allow for expansion of the existing quarry; mining activity is limited to the boundary of the current quarry due to land use restrictions, which include residential setbacks to the west, south, and east, U.S. Highway 30 to the northeast, and Metro property to the northwest where trail sections are proposed. Therefore, this alternative would involve continued aggregate extraction primarily within the current quarry footprint. Most of the land adjacent to the active quarry is vegetated by a mixed coniferous and deciduous forest. Site topography includes rolling hills that define generally east-to-west drainages. The western portion of the site was logged in the 1980s and the site likely has a long history of logging.

The following subsections evaluate Angell Quarry under the Phase 2 Screening Criteria.

Table 8
ODOT Region 1 Aggregate Source Product Compliance for Angell Quarry

Test	Material Source No. 26-018-1 for Riprap Product Compliance
ODOT Laboratory No.	23-000247
Laboratory Date	2/15/2023
Abrasion (% loss)	
Oregon Degradation	P20: 16.6% Height: 0.4 inch
Specific Gravity (OD)	2.67
Specific Gravity (SSD)	2.71
Apparent Specific Gravity	2.77
Absorption	1.30%
Soundness	0.80%

Note:
Source: Knife River

3.1.3.3.1 Criterion 1: Have Direct Access to Multiple Modes of Transportation

Angell Quarry has direct access to multiple modes of transportation to deliver aggregate to the local market (Appendix A, Figure 9). The quarry has an existing unpaved road network for haul truck access. It is located along U.S. Highway 30 and has direct truck access for delivery of aggregate materials. U.S. Highway 30 is an OHP designated freight route (ODOT 2021b). The quarry is also located near the Portland and Western Railroad, which provides freight rail transport of aggregate materials along the northeast side of U.S. Highway 30. One 1,900-ton rail shipment replaces 63 haul trips to Portland, which results in lower GHG emissions similar to Watters Quarry Phase II. The Applicant operates the Linnton Barge Site, located approximately 2.2 miles southeast of the quarry on NW Marina Way in Portland. This barge site provides marine transport to the Applicant’s Sundial facility in Troutdale, Oregon. One 7,000-ton barge owned by the Applicant would be available to transport aggregate into Portland, which would otherwise require 233 truck trips. Averaging 2 hours per truck trip, approximately 4,334 gallons of diesel fuel usage equates to approximately 45 tons of total CO_{2e} emissions to transport the equivalent amount of aggregate as one barge trip (Bridgewater Group 2022).

This alternative has direct access to road, rail, and barge transportation options and relatively low GHG emissions and meets Criterion 1.

3.1.3.3.2 Criterion 2: Have a Maximum Average Overburden Depth of 20 Feet

Overburden on the site is primarily Quaternary Age Portland Hills Silt, which is characterized as an eolian deposit or loess (Lentz 1981; Evarts et al. 2016; Wells et al. 2020). Borings conducted at the

site, a measured section, and numerous highwall exposures suggest that the overburden at the Angell Quarry site and surrounding areas range in thickness from 20 to 75 feet, with an average thickness of 40 feet. This equates to approximately 2.1 million cubic yards of overburden. Due to rock weathering, approximately 6 million cubic yards of reject rock would also be generated that must be stored and managed on site. Assuming an average cost of \$3.50 per cubic yard to remove and manage overburden and reject rock, the estimated cost for Angell Quarry would exceed \$28 million, which equates to approximately \$162,000 per acre and is cost-prohibitive. Considering the removal and management of overburden material and interflow deposits (reject rock), total diesel usage was estimated to be approximately 1,871,615 gallons, which results in approximately 19,284 metric tons of total CO_{2e} emissions (Bridgewater Group 2022).

The Angell Quarry site has an average overburden depth of more than 20 feet, which is cost -prohibitive and results in higher total CO_{2e} emissions. Therefore, Angell Quarry does not meet Criterion 2.

3.1.3.3.3 Criterion 3: Be Located Away from Conflicting Land Uses

The Angell Quarry site is bounded by Conservation Easements and Scenic Buffer areas to the south, west, and north and BPA Powerlines and U.S. Highway 30 to the east. Lands adjacent to the site are zoned CFU-1, CFU-2, and Rural Residential (RR). Residences are present in these areas, primarily along the western edge of the site and along U.S. Highway 30 to the northeast. Lands on the northeast side of U.S. Highway 30 near the site are zoned Multiple Use Agriculture (MUA20). The required setbacks for the mining operation would minimize any adverse effects on nearby properties. The closest residence to the existing quarry is located approximately 2,000 feet to the west with additional low-density residences located farther away from the quarry on the hills to the south and west.

This alternative is located at least 50 feet from all property lines and 200 feet from all residences or residentially zoned properties, which are the required setback distances from conflicting sensitive uses and meets Criterion 3.

3.1.3.3.4 Criterion 4: Minimize Potential Adverse Social and Economic Impacts on Adjacent Communities

Residential properties are located near Angell Quarry. Without controls, these properties may be susceptible to environmental disturbances from noise and dust of mining operations. The crushing plant at Angell Quarry has a DEQ Air Contaminant Discharge Permit, which regulates emissions from this source and any fugitive dust from haul roads on site. The plant has water spray nozzles at the crushers and transfer points to minimize particulate matter in the air. All the haul roads on site are gravel, and water is used if necessary to keep any fugitive dust down. Mining operations would comply with DEQ noise control standards, as required by the Multnomah County Zoning Code

(Section 39.7315). Access to Angell Quarry is through existing roads, and existing transportation system would not be disrupted by this alternative.

This alternative would minimize impacts on socioeconomics and neighboring communities and meets Criterion 4.

3.1.3.3.5 Criterion 5: Minimize Potential Adverse Environmental Impacts

No field surveys of plants, fish, and wildlife use have been completed for the Angell Quarry site, nor were they required by the existing DOGAMI operating permit. As such, publicly available online databases and mapping were reviewed for information to inform this criterion assessment. The Angell Quarry site consists of an active quarry that is surrounded by mixed deciduous and coniferous forest. The USFWS NWI online mapper shows some headwater drainages (streams) outside of the existing quarry and one diked or impounded palustrine unconsolidated bottom wetland with a semi-permanently flooded water regime (PUBFh) on the site (USFWS 2022). This wetland has been created or modified by a human-made impoundment that obstructs the inflow or outflow of water. A wetland delineation has not been performed for the Angell Quarry site; however, the NRCS Web Soil Survey indicates that the entire site as well as adjacent surrounding lands are underlain by non-hydric soils with limited hydric inclusions (NRCS 2022).

The Multnomah Channel is approximately 1,000 feet downslope to the east of the site. The Oregon Explorer online map viewer (OSU 2022) indicates that essential salmonid habitat and fish presence occurs in the Multnomah Channel, including spring- and fall-run Chinook salmon, coho salmon, and winter-run steelhead. The quarry uses on-site settling ponds to control water flow and settle out any suspended solids prior to discharging off site. Stormwater from the quarry drains through a pipe to the east across U.S. Highway 30 and into the Multnomah Channel. This alternative would continue to implement stormwater controls and BMPs as required by the NPDES permit; therefore, it is designed to minimize stormwater impacts in receiving waters. BMPs implemented at the Angell Quarry site include but are not limited to seeding bare soils annually to reduce soil erosion, placement of rock check dams to capture sediment in on-site drainage ditches, construction of holding ponds to further settle out sediment, utilizing baker tanks and sand filters to filter out sediment prior to off-site discharge, and a wheel wash system to prevent the tracking of sediment to public or private roads.

The USFWS IPaC database lists one federally threatened mammal species (Columbian white-tailed deer [*Odocoileus virginianus leucurus*]), three federally threatened bird species (Northern spotted owl, Streaked horned lark [*Eremophila alpestris strigata*], and Yellow-billed cuckoo [*Coccyzus americanus*]), and one federally threatened plant species (Nelson's checker-mallow [*Sidalcea nelsoniana*]) that may be present and potentially affected by activities in this location. The Columbia River population of Columbian white-tailed deer is found in just a few locations in riparian

ecosystems along the lower Columbia River in Oregon and Washington. The Angell Quarry site does not contain riparian habitat; therefore, Columbian white-tailed deer presence is unlikely. Northern spotted owl presence is also unlikely due to ongoing quarry operations, and the closest designated Northern spotted owl critical habitat is located in the Oregon coast range over 30 miles west of the existing quarry. No critical habitat for Streaked horned lark or Yellow-billed cuckoo is mapped in the vicinity of the Angell Quarry site. Continued quarry operations may also result in noise that may affect sensitive animal species on adjacent lands; however, due to ongoing quarry operations at the site, the presence of BPA transmission lines and U.S. Highway 30, and other land disturbances in the area, animals in the vicinity of the quarry are likely capable of avoidance or adapted to these existing operations.

Because this alternative does not allow for expansion of the existing quarry, continued operation is unlikely to result in potential adverse impacts to sensitive species and habitat. However, the site has an average overburden depth of more than 20 feet, which results in relatively higher total GHG emissions; therefore, it does not meet Criterion 5.

3.1.3.3.6 Criterion 6: Minimize Potential Adverse Impacts on Cultural Resources

The Oregon SHPO online mapper does not show any historic resources or archaeological sites at or near the Angell Quarry. The closest mapped sites are more than one mile away and include houses and other buildings.

In absence of a cultural resource survey, it is assumed that this alternative would not have adverse impacts on cultural resources and meets Criterion 6.

3.1.3.4 Farmington Quarry

Farmington Quarry (Alternative 57 in Table 3) is an existing basalt mine owned by the Applicant, located in unincorporated Washington County, Oregon (Appendix A, Figure 1). This alternative consists of two adjacent mine sites, Farmington Quarry and Koehler Quarry, but is referred to as Farmington Quarry in this analysis. Mining has been occurring on this site since the 1950s. It is generally bound by SW Farmington Road (Oregon Route 10) to the west and north, SW Koehler Road to the south, and SW Grabhorn Road to the east. It is located within tax lots 1S2260000400, 1S2260004400, 1S2260004600, 1S2260005100, 1S2260005700, 1S2260005000, 1S226C002300, 1S226DD00300, 1S226DD00600, 1S226DD00400, 1S2350000300, 1S2350000200, 1S2350000101, and 1S2350000102 (Appendix A, Figure 10). All of these tax lots are zoned as Exclusive Forest and Conservation (EFC) or Exclusive Farm Use (EFU; Appendix A, Figure 11).

The tax lots are also within the Washington County's Mineral and Aggregate Overlay District A. The EFC and EFU zoning designations allow for mining, crushing, or stockpiling of aggregate or other mineral and subsurface resources if permitted through a Type II land use review procedure, subject to an impartial or Hearings Officer review and approval. Farmington Quarry was granted land use

approval from Washington County to perform mining operations in 1987 (Casefile 87-571-SU/D). The current casefile number for this site is 17-491QREV. The quarry also has existing DOGAMI operating permits (Permit ID No. 34-0010 for Farmington Quarry and Permit ID No. 34-0007 for Koehler Quarry) and DEQ 1200-A Stormwater Permits (Permit No. 107338 for Farmington Quarry and Permit No. 103961 for Koehler Quarry). The site was determined to be a significant Mineral and Aggregate Area Goal 5 resource by Washington County. This alternative is permitted to expand the mining operation to approximately 300 acres. A complete expansion of the Project site will provide more than 50 years of permitted reserves at current production rates. This alternative would involve continued mining activity within the current quarry footprint and expansion to adjacent land. Most of the land adjacent to the active quarry is disturbed or vegetated by grasses and forbs. Some deciduous and coniferous trees are also present in the area.

Exposures of the aggregate resource at Farmington Quarry consist of two members of the Grand Ronde Basalt of the CRBG. Grand Ronde flows typically yield high-quality resource unless the rock is strongly weathered. The upper flow within the quarry are generally more weathered, particularly along flow contacts, but overall weathering decreases with depth. Accordingly, rock quality improves with depth. Based on laboratory testing of rock core samples and crushed products from the site, Farmington Quarry is capable of producing a variety of aggregate products that meet ODOT acceptance criteria (see Table 2 for a description of ODOT basalt rock quality tests and baseline specifications) including for ACP (Table 9). ODOT identifies the highest material uses of aggregate from the site as being asphalt concrete and base rock (ODOT 2021b). Quarry wall exposures of the basalt exhibit several intra-CRBG member flow contacts that include vesicular zones, palagonite/limonite deposits with a high degree of alteration, and clay accumulations. Some of the flows are also highly weathered and produce reject rock; therefore, they do not have resource value.

Table 9
ODOT Region 1 Aggregate Source Product Compliance for Farmington Quarry

Test	Material Source No. 34-080-1 for 1/2" #4 ACP Product Compliance	Material Source No. 34-080-1 for Riprap Product Compliance
ODOT Laboratory No.	22-000934	22-001701
Laboratory Date	5/19/2022	8/10/2022
Abrasion (% loss)	17.20%	
Oregon Degradation	P20: 12.8% / Height: 0.4 inch	P20: 16.0% / Height: 0.5 inch
Specific Gravity (OD)	2.71	2.78
Specific Gravity (SSD)	2.76	2.80
Apparent Specific Gravity	2.87	2.83
Absorption	2.00%	0.60%
Soundness	3.00%	0.80%

Note:
Source: Knife River

The Farmington Quarry site has a minable area of approximately 300 acres that would last more than 50 years at current production rates. Farmington Quarry is considered to have large quantities of minable basalt.

The following subsections evaluate Farmington Quarry under the Phase 2 Screening Criteria.

3.1.3.4.1 Criterion 1: Have Direct Access to Multiple Modes of Transportation

Access to and from Farmington Quarry is provided solely by a private road off Oregon Route 10. The quarry is located approximately 0.4 mile from Oregon Route 10, which provides transportation access from the quarry to the market area (Appendix A, Figure 12). Oregon Route 10 is used by freight traffic, although it is not a designated OHP Freight Route (ODOT 2021b). Access within the site would be provided using existing unpaved haul roads. As the quarry is expanded, new access roads would be constructed within the footprint of the mined area.

No freight rail, barge, or other modes of transportation are available to transport material from Farmington Quarry to market. As such, aggregate material can only be hauled by truck, resulting in greater GHG emissions as compared to rail and barge, as well as higher production costs per unit volume.

Farmington Quarry does not have access to multiple modes of transportation; therefore, it does not meet Criterion 1.

3.1.3.4.2 Criterion 2: Have a Maximum Average Overburden Depth of 20 Feet

The overburden depth at the Farmington Quarry site averages about 15 feet. This site has an estimated 8 million cubic yards of overburden and weathered basalt reject rock that must be stored and managed on site. Assuming an average cost of \$3.50 per cubic yard to remove and manage overburden and reject material, the total estimated cost for Farmington Quarry would be approximately \$28 million, which equates to approximately \$93,000 per acre and is not cost-prohibitive. Considering the removal and management of overburden material and interflow deposits (reject rock), total diesel usage was estimated to be approximately 1,411,697 gallons, which results in approximately 14,545 metric tons of total CO_{2e} emissions (Bridgewater Group 2022).

The overburden depth at the Farmington Quarry site averages less than 20 feet, which is not cost-prohibitive; therefore, it meets Criterion 2. However, this alternative generates relatively higher total CO_{2e} emissions compared to the Brightwood Quarry and Watters Quarry Phase II.

3.1.3.4.3 Criterion 3: Be Located Away from Conflicting Land Uses

Lands adjacent to Farmington Quarry are zoned Institutional District (INST), Future Development 20-acre District (FD-20), Agriculture and Forest District, 5-acre minimum lot size (AF-5), and Agriculture and Forest District, 20-acre minimum lot size (AF-20). A BPA powerline easement and low-density residential developments are present west of the quarry, with higher density residential

uses present to the east along SW Grabhorn Road. Jenkins Estate, a 68-acre wooded park, is located to the north. The closest residence to the existing quarry is located approximately 50 feet to the north from the eastern portion of the quarry. In addition, one of the trails located at the Jenkins Estate comes within 300 feet of the existing quarry.

Noise-sensitive uses are located less than 500 feet from the quarry. Given the close proximity of proposed mining operations to sensitive residential and recreational land uses, Farmington Quarry does not meet Criterion 3.

3.1.3.4.4 Criterion 4: Minimize Potential Adverse Social and Economic Impacts on Adjacent Communities

Farmington Quarry is located near residentially zoned parcels, which may be susceptible to environmental disturbances from noise and dust of mining operations. Residential development has encroached on the east and northeast limits of the quarry, with most residences being constructed beginning in the mid-1990s, decades after quarry operations had begun. Mining would continue in these areas under this alternative; however, rock blasting has been and would continue to be monitored for vibration. Impacts to residential parcels resulting from noise, dust, and truck traffic would be minimized according to regulatory requirements.

The crushing plant at Farmington Quarry has a DEQ Air Contaminant Discharge Permit, which regulates emissions from this source and any fugitive dust from haul roads on site. The plant has water spray nozzles at the crushers and transfer points to minimize particulate matter in the air. All the haul roads on site are gravel, and water is used if necessary to keep any fugitive dust down.

Mining operations would comply with the Washington County hours of operation, which restricts blasting to the hours between 9:00 a.m. and 6:00 p.m. except for weekends and holidays (Washington County Community Development Code Section 397-13.4). Exceptions to the hours of operations can be granted through a county land use procedure. Access to Farmington Quarry is through existing roads. The existing transportation system would not be disrupted by this alternative.

While this alternative would minimize impacts on socioeconomics and neighboring communities through permit compliance, noise-sensitive uses are located less than 500 feet from the quarry. Given the close proximity of proposed mining operations to these sensitive communities, Farmington Quarry does not meet Criterion 4.

3.1.3.4.5 Criterion 5: Minimize Potential Adverse Environmental Impacts

No field surveys of plants, fish, and wildlife use have been completed for the Farmington Quarry site, nor were they required by the existing DOGAMI operating permit. As such, publicly available online databases and mapping were reviewed for information to inform this criterion assessment. The Farmington Quarry site consists of an active quarry, disturbed grasses and forbs, and deciduous and

coniferous trees. Site topography consists of gradually sloping terrain except for the steep slopes associated with the active mining site. The USFWS NWI online mapper shows a few drainages (streams) that traverse the existing quarry and two freshwater ponds with an artificially flooded water regime and one freshwater emergent wetland with a seasonally flooded water regime on the site (USFWS 2022). A wetland delineation has not been performed for the Farmington Quarry site, so it is possible additional wetlands and streams exist on the site. The NRCS Web Soil Survey indicates that the site and adjacent surrounding lands are underlain by a mix of hydric and non-hydric soils with limited hydric inclusions (NRCS 2022). The Oregon Explorer online map viewer (OSU 2022) does not show any fish species present on or near the site.

The USFWS IPaC database lists three federally threatened bird species (Northern spotted owl, Streaked horned lark, and marbled murrelet [*Brachyramphus marmoratus*]), one federally endangered insect (Fender's blue butterfly [*Icaricia icarioides fenderi*]), and three federally threatened plant species (Nelson's checker-mallow, Kincaid's Lupine [*Lupinus sulphureus ssp. Kincaidii*], and Willamette daisy [*Erigeron decumbens*]) that may be present and potentially affected by activities in this location. No suitable habitat is present at or near the site for Northern spotted owl or marbled murrelet and the closest designated critical habitat for these species is in the Oregon coast range. No critical habitat for Fender's blue butterfly or the listed plant species is mapped in the vicinity of site native, nor is there suitable prairie habitat in or near the site.

Stormwater from the quarry discharges to a small tributary to McKernan Creek, which drains to the Tualatin River. McKernan Creek and its tributary provide habitat for fish, although no species-specific information is available. With implementation of BMPs required by the NPDES permit, including on-site settling ponds to control water flow and settle out any suspended solids prior to discharge, impacts on fish would be negligible.

Continued quarry operations may result in noise that may affect sensitive animal species on adjacent lands. Due to existing ongoing quarry operations at the site, the presence of BPA power lines and Oregon Route 10, surrounding residential and agricultural development, and other land disturbances in the area, suitable habitat for sensitive species is not likely to be present on other lands in the vicinity of the quarry.

While this alternative would minimize potential adverse impacts to sensitive species and habitat, it would result in relatively high GHG emissions from transportation of aggregate material (see Criterion 1 discussion); therefore, it does not meet Criterion 5.

3.1.3.4.6 Criterion 6: Minimize Potential Adverse Impacts on Cultural Resources

The Oregon SHPO online mapper does not show any historic resources or archaeological sites at the Farmington Quarry. However, the closest mapped site includes the Jenkins Estate and its associated

gardens and buildings located immediately northeast of the site and therefore, does not meet Criterion 6.

4 Site Selection Alternatives Summary

All of the four alternatives were evaluated based on the Phase 2 Screening Criteria. The Watters Quarry Phase II is the only alternative that met all of the Phase 2 Screening Criteria. The Brightwood Quarry, Angell Quarry, and Farmington Quarry alternatives did not meet all screening criteria and were eliminated from further consideration. Rationale for the elimination of these alternatives is presented in the following:

- **Brightwood Quarry:** Criterion 1 was not met. This alternative was eliminated from consideration because it does not have direct access to multiple modes of transportation. Materials mined from this alternative could only be transported using haul trucks, as no other forms of transportation are available at its location. Transport of aggregate using only trucking would negatively impact the physical infrastructure of the region's transportation system and contribute to increased congestion and capacity issues for U.S. Highway 26. This alternative also results in greater GHG emissions due to lack of access to rail and barge transportation options as well as the lengthy transportation distance required to bring aggregate to market compared to the other Phase 2 sites. Diesel usage for truck transport generates approximately 45 metric tons of total CO₂e emissions, which results in approximately 38% more GHG emissions compared to one barge transporting the same amount of aggregate.
- **Angell Quarry:** Criterion 2 was not met. This alternative was eliminated from further review because average overburden thickness for the site is greater than 20 feet. As previously stated, overburden thickness across this site ranges from 20 to 75 feet, with an average thickness of 40 feet. Excessive overburden at this site would result in large quantities of material being stored in stockpiles on the site. Given the steep terrain and heavy annual precipitation at this site, storage of large overburden volumes would result in an increased risk of erosion off site and into receiving waters. Erosion and sedimentation can be controlled using BMPs; however, large volumes of erodible materials can be difficult to manage without risk. In addition, excavation, movement, and management of large quantities of overburden would increase the cost of Project development, logistical complexity of the Project, and increase GHG emissions as a result of additional equipment used. The estimated cost to manage overburden and reject material for this alternative would exceed \$28 million, which equates to approximately \$162,000 per acre. Total diesel usage to manage this material was estimated to generate approximately 19,284 metric tons of total CO₂e emissions.
- **Farmington Quarry:** Criterion 1 was not met. As with Brightwood Quarry, material can only be transported from Farmington Quarry by truck, as no other transportation options are available. This would result in the same negative impacts detailed within the Brightwood Quarry analysis—degradation to the physical infrastructure of the region's transportation system, increased congestion and capacity issues for roadways, particularly Oregon Route 10,

and greater GHG emissions than the alternatives possessing multiple modes of transportation. GHG emissions associated with transport would also be high without rail or barge options.

Criterion 3, Criterion 4, and Criterion 6 were also not met. Although mining operations at Farmington Quarry predate the encroachment of residential land uses on the east and northeast boundaries of the quarry, noise-sensitive land uses are located within the setbacks for lands within Mineral and Aggregate Overlay District A. Expanded operations at this alternative would be located close to conflicting sensitive uses, resulting in community impacts that will be costly and impractical to mitigate and also result in potential adverse impacts on cultural resources (Jenkins Estate).

Finally, although this alternative has an overburden depth that averages less than 20 feet, it generates higher total CO₂e emissions compared to the Brightwood Quarry and Watters Quarry Phase II. This alternative was also eliminated because the GHG impacts from this alternative are greater than that of Brightwood Quarry and Watters Quarry Phase II.

5 Identification of the Practicable Alternative

The Watters Quarry Phase II Project is the only alternative that meets all six of the Phase 2 selection criteria (Table 4). Of the four alternatives evaluated within Phase 2, Watters Quarry Phase II has the least amount of overburden, is located away from conflicting land uses, and is tied with the Angell Quarry for having the largest number of transportation options.

Watters Quarry Phase II meets or exceeds the controls established in each of the six Phase 2 Screening Criteria. As previously discussed, the resource quality at Watters Quarry Phase II is excellent. The basalt observed in the current Watters Quarry Phase I and in the Phase II area is more uniform and less weathered than most other CRBG sources in the Portland region. The CRBG at Watters Quarry Phase II also contains less weathered rock (reject material) than the other alternatives that were analyzed. Due to its geologic history, where overburden soils were scoured away by the Missoula floods, overburden is minimal. Watters Quarry Phase II's limited overburden and reject material volume provides a distinct advantage with respect to cost and non-resource material management and limits on-site GHG impacts. Overburden and reject rock management at the Watters Quarry Phase II site would cost approximately \$62,000 per acre compared to the other Phase 2 alternatives, where costs range from approximately \$83,000 to \$162,000 per acre. Watters Quarry Phase II would also generate the lowest quantity of GHG emissions (approximately 2,740 metric tons of total CO_{2e} emissions) from the removal of overburden and reject material, whereas the other alternatives would generate between 3,609 and 19,284 metric tons of total CO_{2e} emissions. Even though all of the four alternatives contain amounts of high-quality crushed aggregate resource, the volume and uniformity of the CRBG, limited overburden and reject material, and relatively low GHG emissions at Watters Quarry Phase II makes this alternative the best site for achieving this criterion.

Watters Quarry Phase II has access to multiple modes of transportation, including road, rail, and barge transport. By providing multiple forms of transportation, traffic and infrastructure impacts on U.S. Highway 30 will be minimized. Additionally, the use of rail and barge for aggregate transport will significantly reduce the off-site GHG emissions associated with this alternative. Compared to trucking, barging aggregate to market would result in approximately 38% less total GHG emissions over a shipment year. Furthermore, transporting by rail reduces GHG emissions by approximately 17% per train trip compared to each truck trip.

Watters Quarry Phase II proposes to utilize an existing, known, CRBG resource that will provide certainty with respect to the rock quality, management of potential off-site impacts, and local land use approvals. The Applicant has developed detailed plans for mitigation of critical areas, management of on-site and off-site mining impacts, and protection of cultural resources, while still achieving the stated Project purpose of developing a dependable crushed aggregate resource to

provide high-quality, multiproduct, cost-competitive aggregate materials to the Portland Metropolitan Market.

The Portland Metropolitan Market's need for a new affordable long-term local source of high-quality crushed aggregate is clear, especially as many existing resources that are supplying present-day demand are being depleted at a rapid rate. With the Portland Metropolitan Service Area experiencing a population boom amidst an ongoing affordable housing shortage, aging infrastructure assets that are presently at, or exceeding capacity, and upcoming programmed infrastructure projects resulting from the Bipartisan Infrastructure Law,⁴ this Project is needed to meet the present and future demand for aggregate material. Watters Quarry Phase II represents one of the three largest aggregate reserves available to the Portland Metropolitan Service Area, and the only aggregate reserve available in the region with high-quality basalt that meets all of the Phase 1 and Phase 2 Alternative analysis screening criteria. Therefore, based on this analysis of the screening criteria, the Watters Quarry Phase II location is the site that qualifies as a practicable alternative.

⁴ Infrastructure Investment and Jobs Act, P.L. 117-58 (2021).

6 On-Site Alternatives Analysis

Following the identification of Watters Quarry Phase II site as the only site that meets the practicable alternative screening criteria, the Applicant analyzed and considered several alternative Project layouts and configurations to avoid and minimize Project impacts to State waters and wetlands and other waters/wetlands present at the Project site. In conducting its environmental analysis, the application has concluded that the Project purpose and need cannot be achieved through total avoidance of State waters and wetlands and other waters/wetlands present at the Project site. This conclusion is due to the location and configuration of existing wetland and water resources on the site, and the nature of aggregate mining, which requires significant ground-disturbing activities to extract resource material. The following sections detail the on-site alternatives that the Applicant has considered, in reaching a conclusion that Alternative 2 is the LEDPA.

6.1 Alternative 1—No Direct Impact Alternative

This alternative considers a site design for the mining area of Watters Quarry Phase II that avoids all direct impacts to State waters and wetlands and other waters/wetlands present at the Project site. This alternative does not achieve the Project's purpose and need because the Applicant will be unable to produce a sufficient quantity of high-quality aggregate resource necessary to meet the present and future needs of the Portland Metropolitan Service Area, as mining activity would be limited to a very small portion of the Project site's overall acreage in order to avoid direct impacts to the existing wetlands and waterways that exist throughout large portions of the site.

Conducting mining activity within small and isolated areas of the site would result in sporadic and incongruent areas of ground disturbance. This alternative would require the Applicant to expend significant technical effort to overcome site conditions because the Project site is interwoven with wetlands and water resources. Mining within these "pockets" would be logistically impracticable, highly inefficient, and inconsistent with accepted standards for aggregate extraction within the mining industry. Undertaking this alternative would require the Applicant to implement extraordinary engineering controls to ensure that mining in isolated site pockets will not have direct impacts on existing wetlands and water resources. In addition, conducting resource extraction in isolated pockets of the site will result in the fragmentation of the site and could cause indirect impacts to adjacent and downslope wetlands due to hydrology modifications and buffer impacts.

This alternative is also cost-prohibitive as mining in isolated areas of the site will eliminate the Applicant's ability to stage mining activities in an efficient and cost-effective manner. Conducting mining activity consistent with this alternative would require the Applicant to undertake greater expenditures in terms of fuel, equipment hours, and workforce, while simultaneously producing an extremely limited resource yield that is inconsistent with the Project's purpose and need. In addition,

this alternative would present significant logistical and cost challenges for the Applicant in terms of overburden management. Sufficient acreage is required to effectively manage overburden and reject rock within the mining area. This alternative will require the Applicant to expend significant technical effort and implement extraordinary engineering controls to manage overburden at the Project site while ensuring that no direct impacts occur to wetlands and water resources. These measures would result in aggregate that is cost-prohibitive to mine and therefore, noncompetitive in the market.

Alternative 1 was rejected because it is logistically impracticable, cost-prohibitive, and would not meet the proposed Project purpose and need.

6.2 Alternative 2—Preserve Wetlands A, B, C, F, G, U, Z, DD, EE, FF, OO, PP, TT, and 1-A and Ephemeral Streams B, C, D, and 1-A and Perennial Stream 1-A and Implement Compensatory Mitigation Plan

Alternative 2 proposes to conduct mining activities within a 70-acre area on the Project site (Figure 8 of this JPA). The proposed mining area excludes the required setbacks from adjacent parcels. To meet the Project's purpose and need while achieving maximum practicable avoidance of State waters and wetlands and other waters/wetlands, Alternative 2 focuses on preserving the wetlands and streams in the northern, western, and southern portions of the Project site and limiting the mining area to 70 acres in the central and eastern portions of the Project site (Attachment D, Figure 3).

Many of the wetlands and streams identified for preservation within this alternative are higher in the watershed and closer to some of the major hydrologic sources (e.g., streamflow from Perennial Stream 1-A that enters Wetland A from the culvert under Liberty Hill Road, subsurface seepage from the steep hillside upslope from Wetland B, surface runoff) that currently support on-site wetlands and streams. Alternative 2 would preserve Wetlands A, B, C, F, G, U, Z, DD, EE, FF, OO, PP, TT, and 1-A, which total approximately 7.14 acres, and Ephemeral Streams B, C, D, and 1-A and Perennial Stream 1-A, which total 0.019 acre (Attachment D, Figure 3).

Wetland impacts from Alternative 2 include the removal of approximately 10.23 acres of wetlands and 0.002 acre of intermittent stream. Mining operations may also indirectly impact approximately 1.42 acre of wetlands and 0.058 acre of intermittent streams by disrupting or reducing surface and subsurface flows that currently feed into those areas. The alteration of these hydrology sources may result in the complete loss of those wetlands and streams over time; therefore, they are included in the impact total.

Compensatory mitigation under Alternative 2 would occur in areas surrounding these wetlands and streams in accordance with the compensatory mitigation plan (Attachment D to this JPA) and would bring the total area of wetlands present in this location of the site to approximately 25.53 acres, representing an increase of 6.75 acres of wetland than is currently present at the Project site.

Successful compensatory mitigation would primarily be achieved through use of available on-site water. Water for some of the created wetlands will come from capturing direct precipitation, similar to the predominant hydrologic source for the existing wetlands. Compensatory mitigation will also be achieved from capturing and directing upslope surface and subsurface flow into created wetland and stream areas. Alternative 2 would also include long-term monitoring and maintenance of the established mitigation areas and preservation of existing wetlands in perpetuity as part of the mitigation plan.

This alternative is logistically practicable as the Applicant can plan and implement mining activities through a staged approach. Conducting mining activity in stages will not require unreasonable technical effort to overcome site conditions as the Applicant can proactively plan for and manage resource extraction and overburden management activities. Furthermore, the Applicant will not be required to implement extraordinary engineering controls that would impact the long-term viability of the Project because mining will be limited to an identified and discrete area of the Project site.

Current proven technology exists to achieve the Project's purpose and need within the parameters of Alternative 2. The Applicant proposes to utilize the most efficient mining practices and technology available so as to limit the overall site impacts from this Project. Specifically, primary resource processing activities will not occur within the Project site. The Applicant proposes to transport resource material from the Project site to Watters Quarry Phase I for processing and transport to market. Although the Applicant will initially utilize haul trucks to transport material from the Project site to Watters Quarry Phase I, the Applicant ultimately proposes to use a conveyor system to transport material from the Project site to Watters Quarry Phase I once mining activity has sufficiently progressed. The Applicant's proposed plan to conduct primary resource processing activities outside of the Project area will limit on-site Project impacts and represents the Applicant's commitment to utilizing most efficient technologies and logistics in furtherance of the Project's purpose and need.

Alternative 2 is not cost-prohibitive. Although material, equipment, and labor costs are inherent to the mining industry, the Applicant's proposed mining and mitigation plans are practicable in terms of overall Project costs. Overburden and reject rock management under Alternative 2 would be more efficient than under Alternative 1, reducing the potential for impacts to water quality and reducing GHG emissions.

Alternative 2 achieves the Project's purpose and need as it will produce a significant volume of high-quality aggregate resources for use within the Portland Metropolitan Service Area now, and in the future. Simultaneously, this alternative will limit on-site impacts to State waters and wetlands and other waters/wetlands as currently delineated, to the maximum extent practicable while still achieving the Project's purpose and need. This alternative is logistically practicable, and the Applicant currently possesses all necessary technologies to achieve the overall goals and purpose of the proposed Project. Finally, this alternative is not cost-prohibitive as it provides the Applicant with the flexibility

necessary to react and adapt to changing market conditions and future demand to lessen economic costs to the public. Based on this analysis, Alternative 2 represents the LEDPA.

6.3 Alternative 3—Preserve Wetlands L through U, Z, AA, OO, PP, QQ, RR, SS, and XX, and Intermittent Streams B, C, and D

Alternative 3 proposes to avoid 18 wetlands totaling 10.38 acres (Wetlands L through U, Z, AA, OO, PP, QQ, RR, SS, and XX), four intermittent streams totaling 0.06 acre (Intermittent Streams B and its tributary, C, and D), and two ephemeral streams totaling 0.002 acre (Ephemeral Streams C and D) located in the eastern portion of the Project site (Appendix A, Figure 13). In addition, portions of three wetlands totaling 0.57-acre (portions of Wetlands A, B, and C) and portions of two streams (0.001-acre portion of Ephemeral Stream 1-A and 0.004-acre portion of Perennial Stream 1-A) located outside of the proposed mining area would also be avoided.

The remaining portions of these features, in addition to 17 other wetlands (Wetlands D through K, BB, CC, DD, EE, FF, TT, YY, ZZ, and 1-A), and one ephemeral stream (Ephemeral Stream B) would be eliminated by Alternative 3. The total area of direct wetland impact would be approximately 7.83 acres, and the total area of direct impact to other waters (e.g., streams) would be approximately 0.012 acre. Wetland and water avoidance would require expanding mining activity into the western portions of the Project site. Much of the surface and subsurface water feeding the on-site wetlands originates from upslope areas in the northwest portions of the Project site. Conducting mining activity in the northwest portion of the Project site would disrupt sources of water for many of the avoided wetlands and streams in the eastern and western portions of the site, which are generally located downslope of the area that would be mined.

Alternative 3 would require the Applicant to engage in complex hydrologic manipulation in an effort to avoid indirect impacts to the identified State waters and wetlands and other waters/wetlands that Alternative 3 seeks to avoid. This effort is logistically impracticable and limited by existing technology as the upgradient water would need to be captured and routed to multiple wetland areas to attempt to maintain hydrology. Alternative 3 is not the LEDPA, as it would be impracticable to ensure the avoided wetlands would not be indirectly impacted, and proposed mining activity will likely still result in the loss of the avoided wetlands over time. Alternative 3 would also leave minimal space for on-site mitigation to occur, and hydrology for the mitigation area would be more difficult to maintain than Alternative 2. With no mitigation bank or in-lieu fee site service area extending into the Project area, off-site mitigation would be required.

The logistical and technological challenges associated with implementing Alternative 3 are far greater than that of Alternative 2. To achieve this Project's purpose and need within the parameters of Alternative 3—while still limiting impacts to State waters and wetlands and other waters/wetlands—the Applicant will need to undertake significant technical effort and implement

extraordinary engineering controls to overcome site conditions related to on-site hydrologic conditions. Even if the Applicant implements all available BMPs to avoid and retain State waters and wetlands and other waters/wetlands, there is little confidence that the Applicant's efforts will be successful within the parameters of Alternative 3, due to the complex hydrology and interconnectedness of on-site critical resources. The uncertainty regarding the implementation and long-term effectiveness of Alternative 3 has led the Applicant to conclude that Alternative 3 is not a viable alternative that would allow the Applicant to achieve the Project's purpose while also limiting impacts to State waters and wetlands and other waters/wetlands.

The cost associated with implementing Alternative 3 would be higher than that of Alternative 2, due to the Applicant being required to engage in complex hydrologic manipulation to capture and route upgradient water to multiple State waters and wetlands and other waters/wetlands areas that the Applicant is proposing to avoid. Moreover, the acreage limitations that Alternative 3 places upon the mitigation area will result in greater direct and overhead expenses during the lifetime of the Project. As such, the Applicant will be required to develop a complex mitigation plan and devote significant resources to retaining site hydrology to prevent the loss of State waters and wetlands and other waters/wetlands and critical resources designated for avoidance.

Because of the significant logistical and technological challenges associated with implementing Alternative 3, as well as direct and indirect costs, Alternative 3 does not represent the LEDPA or is a viable alternative to achieve the Project's purpose and need. For these reasons, Alternative 3 was rejected by the Applicant.

6.4 Alternative 4—Maximize Potential Aggregate Yield

Alternative 4 would involve maximizing the potential aggregate resource yield of the Project site by conducting mining activity within as much of the Project site as possible (Appendix A, Figure 14). This alternative would involve the complete removal of 35 wetlands and portions of Wetlands A, B, and C (totaling 18.21 acres), a portion of one perennial stream (Perennial Stream 1-A), four intermittent streams (0.06 acre), and three ephemeral streams and a portion of a fourth ephemeral stream totaling 0.009 acre. Under Alternative 4, compensatory mitigation for those impacts would occur at an off-site location because of the need to conduct resource extraction throughout the entirety of the Project site.

Alternative 4 is not viable because it does not implement all appropriate and practicable avoidance and minimization measures. Although Alternative 4 meets the Project's purpose and need of providing a large volume of high-quality aggregate resource to the Portland Metropolitan Service Area, the Applicant has concluded that Alternative 4 cannot be identified as the LEDPA due to its impacts to State waters and wetlands and other waters/wetlands, and other critical resources.

Specifically, the loss in functions and values of critical resources across the site eliminate this alternative from contention; for these reasons, Alternative 4 has been rejected by the Applicant.

7 References

AINW (Archaeological Investigations Northwest, Inc.), 2020. *Archaeological Survey for the Knife River Watters Quarry Project, Columbia County, Oregon*. Prepared for Anchor QEA, Portland, Oregon. Report No. 4376. March 18, 2020.

Anchor QEA, 2021. Memorandum to Daniel Evans, PWS (Oregon Department of State Lands) from Anchor QEA entitled: *Watters Quarry Expansion Project Wetland Delineation Addendum (WD No. 2019 0623)*. March 24, 2021.

ASCE (American Society of Civil Engineers), 2019. "Oregon Infrastructure Receives a "C-" in 2019 Infrastructure Report Card". Last modified May 17, 2019. Available at: <https://csengineermag.com/oregon-infrastructure-receives-a-c-in-2019-infrastructure-report-card/>

Bridgewater Group, 2022. Memorandum to: Jeff Steyaert, Knife River. Regarding: Greenhouse Gas Emissions Analysis for Knife River Watters Quarry Phase 2 Expansion and Alternative Quarry Sites. May 2, 2022.

City of Portland, 2019. "Current Sustainable Procurement Initiatives." Accessed October 2022. Available at: <https://www.portland.gov/omf/brfs/procurement/sustainable-procurement-program/sp-initiatives>.

Council on Foreign Relations, 2021. *The State of U.S. Infrastructure*. Written by James McBride and Anchu Siripurapu. Accessed August 20, 2021. Available at: <https://www.cfr.org/backgrounders/state-us-infrastructure>.

Columbia County Planning Commission, 1995. *Order No. PAC 1-95*. In the matter of: Codifying Planning Information on Significant Aggregate Sites for the Purpose of Amending the Comprehensive Plan During Periodic Review. St. Helens, Oregon. June 23, 1995.

DOGAMI (Oregon Department of Geology and Mineral Industries), 2024a. Surface Mining Permits and Production Information. Accessed March 22, 2024. Available at: https://www.oregon.gov/dogami/mlrr/spreadsheets/Production_db.xlsx.

DOGAMI, 2024b. Surface Mining Permits and Production Information. Accessed March 22, 2024. Available at: https://www.oregon.gov/dogami/mlrr/spreadsheets/Mining_db.xlsx.

Evarts, R.C., 2002. Geologic map of the Deer Island quadrangle, Columbia County, Oregon and Cowlitz County, Washington, U.S. Geological Survey, Miscellaneous Field Studies Map MF-2392, 1:24,000.

- Evarts, R.C., 2004, Geologic map of the Saint Helens quadrangle, Columbia County, Oregon, and Clark and Cowlitz Counties, Washington, U.S. Geological Survey, Scientific Investigations Map SIM-2834, 1:24,000.
- Evarts, R.C., O'Connor, J.E., and Cannon, C.M., 2016, Geologic map of the Sauvie Island quadrangle, Multnomah and Columbia Counties, Oregon, and Clark County, Washington, U.S. Geological Survey, Scientific Investigations Map SIM-3349, 1:24,000.
- GeoDesign, 2021. 2021 Update – Permitted Aggregate Reserves, Clark County, Washington. Letter to ZP#5, LLC. May 7, 2021.
- Lentz, R.L., 1981, *The Petrology and Stratigraphy of the Portland Hills Silt—A Pacific Northwest Loess: Oregon Geology*, v. 43, no. 1, p. 3-10
- Metro, 2016. "2060 growth forecast." *Metro*. April 30, 2016. Available at: <https://www.oregonmetro.gov/2060-growth-forecast>.
- Metro, 2023a. "82nd Avenue transit project". *Metro*. Accessed December 14, 2023. Available at: <https://www.oregonmetro.gov/public-projects/82nd-avenue-transit-project/background>.
- Metro, 2023b. "Tualatin Valley Highway transit project". *Metro*. Accessed December 14, 2023. Available at: <https://www.oregonmetro.gov/public-projects/tualatin-valley-highway-transit-project>.
- NRCS (Natural Resources Conservation Service), 2022. Web Soil Survey. Soil Survey Staff, Natural Resources Conservation Service, U.S. Department of Agriculture. Accessed September 6, 2022. Available at: <http://websoilsurvey.nrcs.usda.gov/app/WebSoilSurvey.aspx>.
- NV5, 2022. *Revised Mine Resource Evaluation Report—Phase 2 Mine Area*. Watters Quarry. July 20, 2022.
- ODOT (Oregon Department of Transportation), 2021a. *Oregon Standard Specifications for Construction*. Accessed October 25, 2023. Available at: https://www.oregon.gov/odot/Business/Specs/2021_STANDARD_SPECIFICATIONS.pdf
- ODOT, 2021b. ODOT's TransGIS mapper. Accessed September 29, 2022. Available at: <https://gis.odot.state.or.us/transgis/>
- ODOT, 2023. "Statewide Transportation Improvement Program". Accessed April 5, 2024, Available at: <https://www.oregon.gov/odot/stip/pages/2024-2027-stip.aspx#:~:text=The%202024%2D2027%20STIP%20invests,state%20funding%20approved%20in%202017.>

- OSU (Oregon State University), 2022. Oregon Explorer – Map Viewer. Accessed September 6, 2022. Available at: http://tools.oregonexplorer.info/oe_map_viewer_2_0/viewer.html?Viewer=OE.
- PGE (Portland General Electric), 2023. "Tonquin Project". PGE. Accessed December 14, 2023. Available at: <https://portlandgeneralprojects.com/projects/tonquin-project/>.
- PHS (Pacific Habitat Services, Inc.), 2019. *Wetland Delineation for Watters Quarry, St. Helens, Oregon*. Prepared for Knife River Corporation – Northwest, Tangent, Oregon. November 11, 2019.
- PHS, 2020a. Memorandum to: Daniel Evans, Oregon Department of State Lands. Regarding: Supplemental Information Regarding the Watters Quarry Wetland Delineation; WD 2019-0623. PHS #6300. July 17, 2020.
- PHS, 2020b. Memorandum to: Daniel Evans, Oregon Department of State Lands. Regarding: Supplemental Information Regarding the Watters Quarry Wetland Delineation; WD 2019-0623. PHS #6300. August 5, 2020.
- Streamnet, 2024. StreamNet, Fish Data for the Northwest. Accessed January 8, 2024. Available at <https://www.streamnet.org/>.
- TriMet, 2023a. "Adopted budget 2022-2023". *TriMet*. Tri-County Metropolitan Transportation District of Oregon Budget & Grants Administration Department. Accessed December 14, 2023. Available at: <https://trimet.org/budget/pdf/2023-adopted-budget.pdf>.
- TriMet, 2023b. "Adopted budget 2023-2024". *TriMet*. Tri-County Metropolitan Transportation District of Oregon Budget & Grants Administration Department. Accessed December 29, 2023. Available at: <https://trimet.org/budget/pdf/2024-adopted-budget.pdf>.
- TriMet, 2023c. "Making Transit Better. Investing in our Infrastructure." *TriMet*. Accessed December 14, 2023. Available at: <https://trimet.org/bettertransit/infrastructure.htm>.
- TriMet, 2023d. "Southwest Corridor Light Rail Project". *TriMet*. Accessed December 14, 2023. Available at: <https://trimet.org/swcorridor/>.
- TriMet, 2024. "Fiscal Year 2025 Proposed Budget". Accessed March 18, 2024. Available at: <https://trimet.org/budget/>.
- USDOT (U.S. Department of Transportation), 2022. Office of Public Affairs. "The Bipartisan Infrastructure Law Will Deliver for Oregon." Accessed December 13, 2023. Available at: https://www.transportation.gov/sites/dot.gov/files/2022-01/BIL_Oregon.pdf

USFWS (U.S. Fish and Wildlife Service), 2022. National Wetlands Inventory Wetlands Mapper.

Updated: October 1, 2020. Accessed September 6, 2022. Available at:

<http://www.fws.gov/wetlands/Data/Mapper.html>

Wells, R.E., Haugerud, R.A., Niem, A.R., Niem, W.A., Ma, Lina, Evarts, R.C., O'Connor, J.E., Madin, I.P., Sherrod, D.R., Beeson, M.H., Tolan, T.L., Wheeler, K.L., Hanson, W.B., and Sawlan, M.G., 2020, Geologic map of the greater Portland metropolitan area and surrounding region, Oregon and Washington, U.S. Geological Survey, Scientific Investigations Map SIM-3443, 1:63,360

Whelan, R.M., 1995. *An Economic Analysis of Construction Aggregate Markets and the Results of a Long-Term Forecasting Model for Oregon*. Oregon Department of Geology and Mineral Industries Special Paper 27, 123 p.

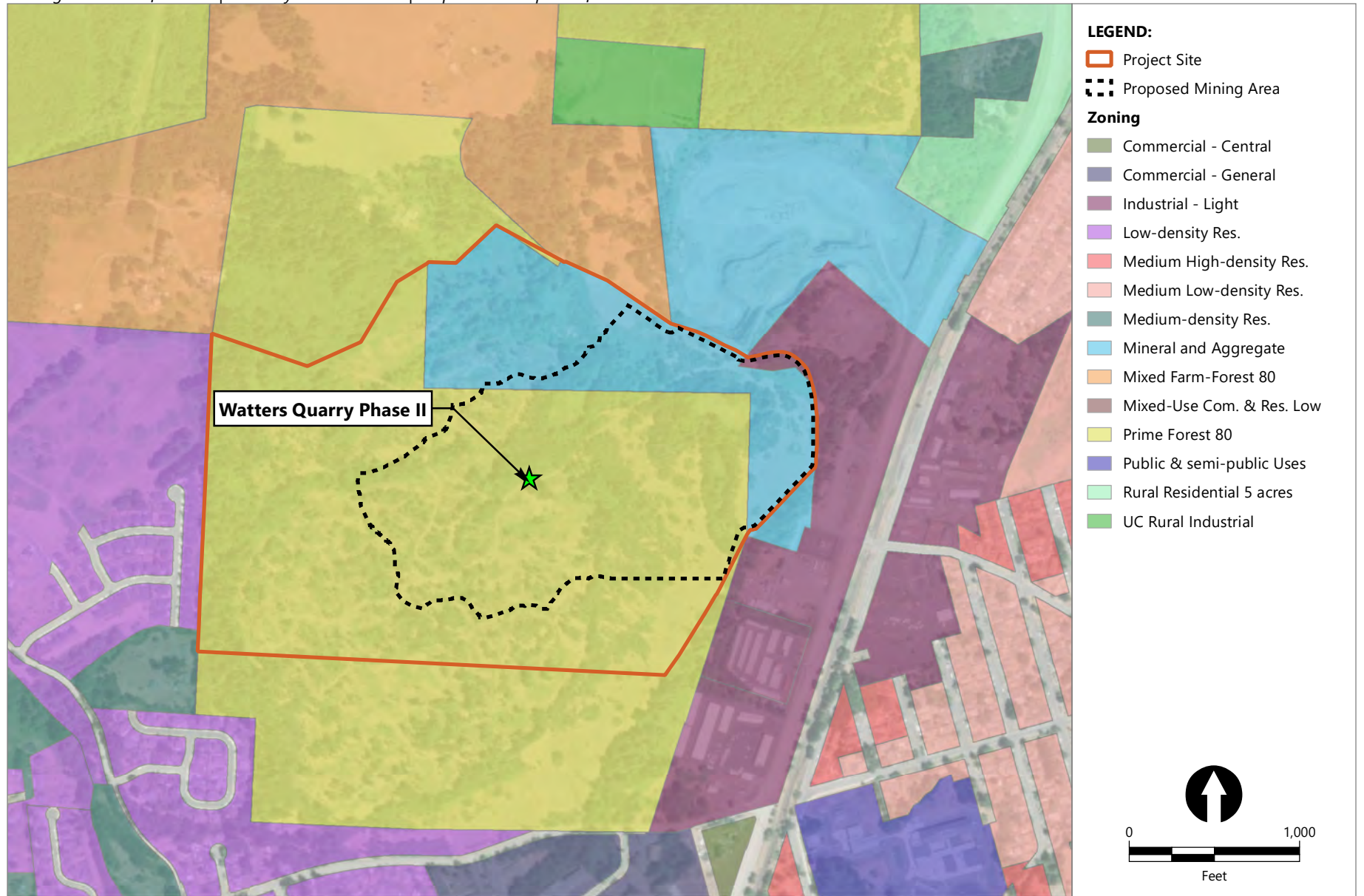
White House, 2021. "President Biden's Bipartisan Infrastructure Law." Accessed October 2022.

Available at: <https://www.whitehouse.gov/bipartisan-infrastructure-law/>.

White House, 2023. President Biden's Bipartisan Infrastructure Law is Delivering in Oregon – As of May 2023. Accessed September 23, 2023. Available at: <https://www.whitehouse.gov/wp-content/uploads/2023/05/Oregon-Fact-Sheet-May.pdf>

Appendix A

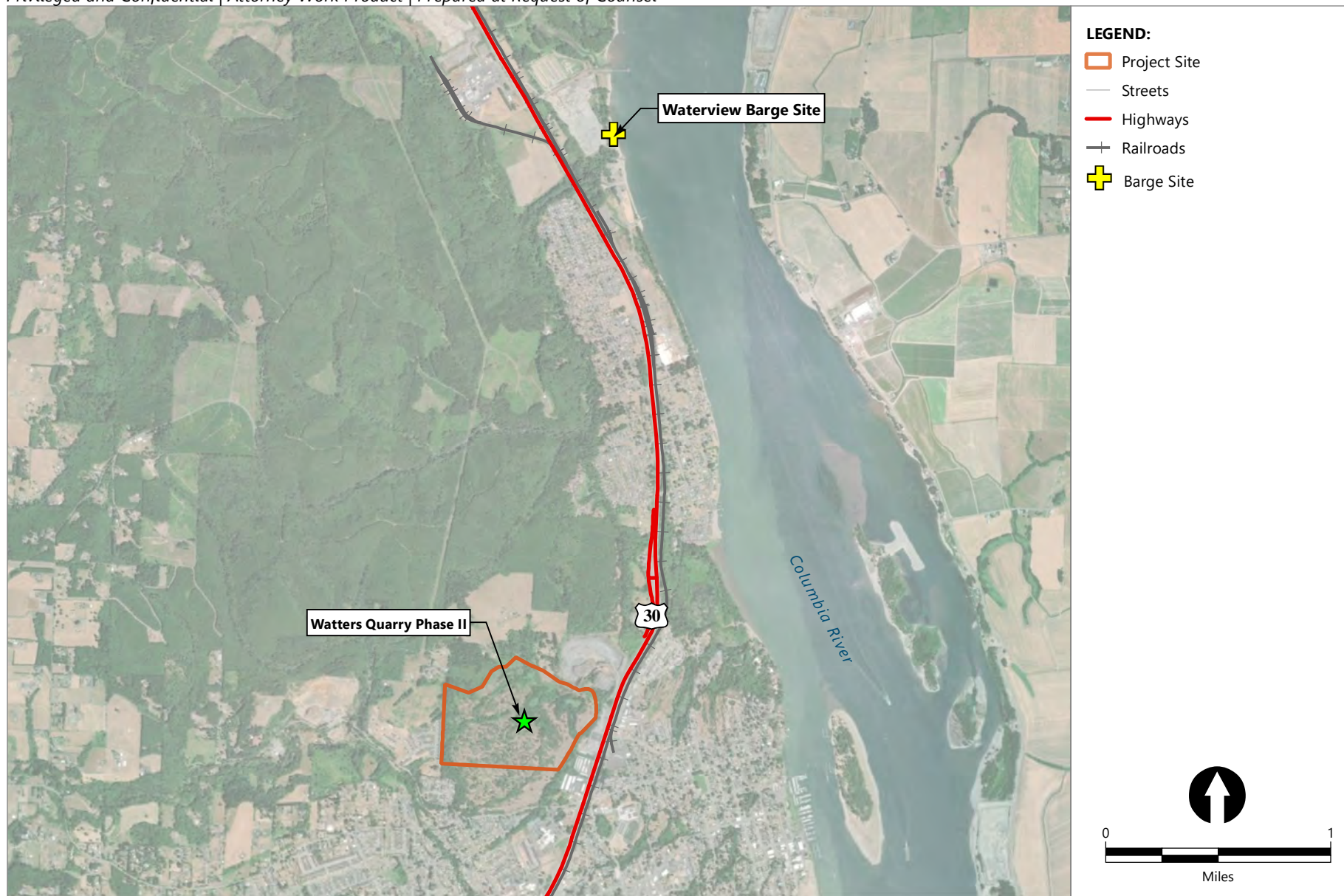
Alternatives Analysis Figures



Publish Date: 2024/01/05, 5:26 PM | User: jfox
Filepath: \\orcas\GIS\Jobs\Knife_River_Corp_2114\Watters_Quarry\Maps\JPA\AQ_JPA_AttachHFig2_Watters_Zoning.mxd



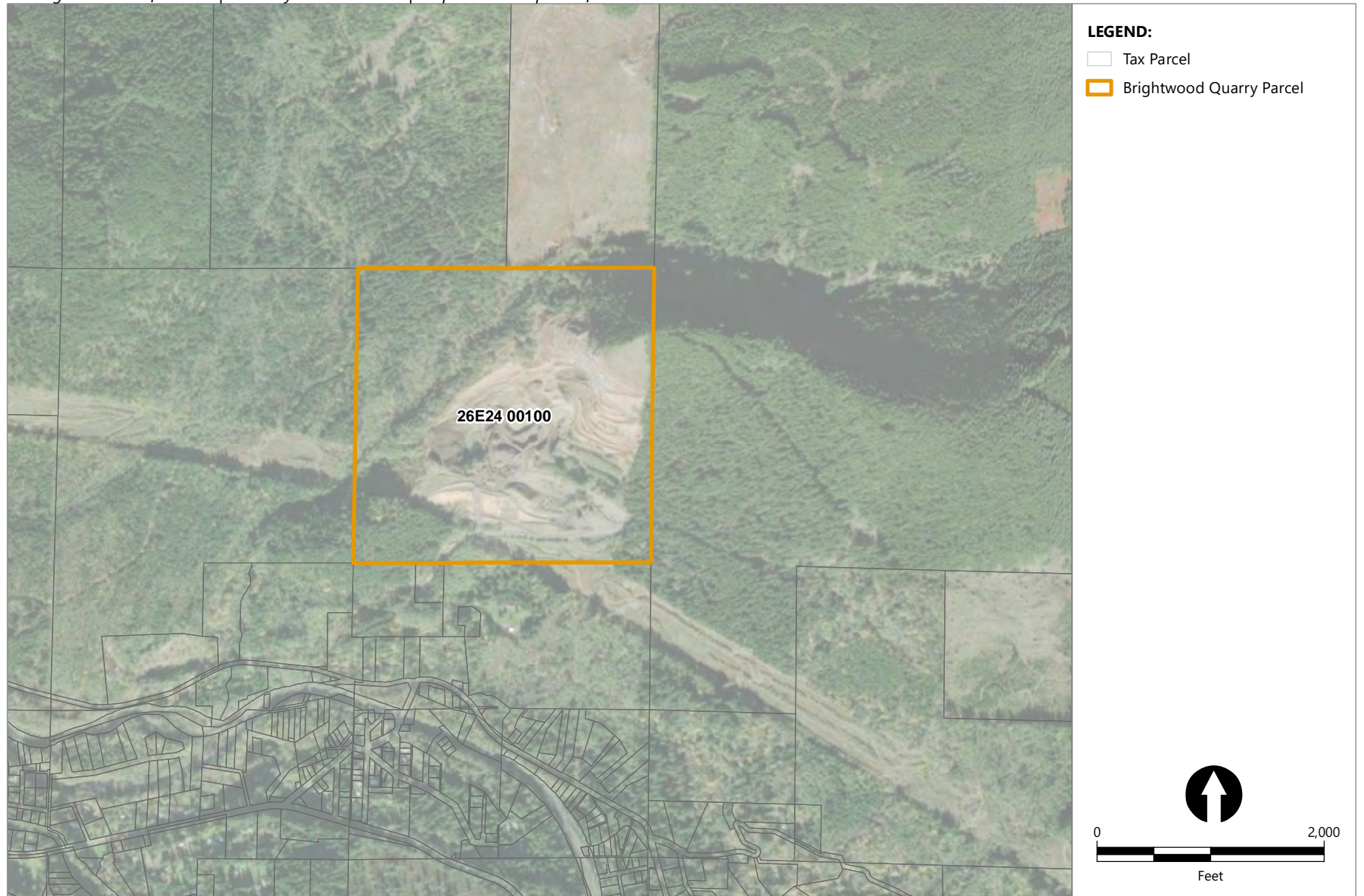
Figure 2
Watters Quarry Zoning
Joint Permit Application - Attachment H
Watters Quarry Phase II Project



Publish Date: 2024/01/05, 5:38 PM | User: jfox
Filepath: \\orcas\GIS\Jobs\Knife_River_Corp_2114\Watters_Quarry\Maps\JPA\AQ_JPA_AttachH\Fig3_Watters_Transportation.mxd



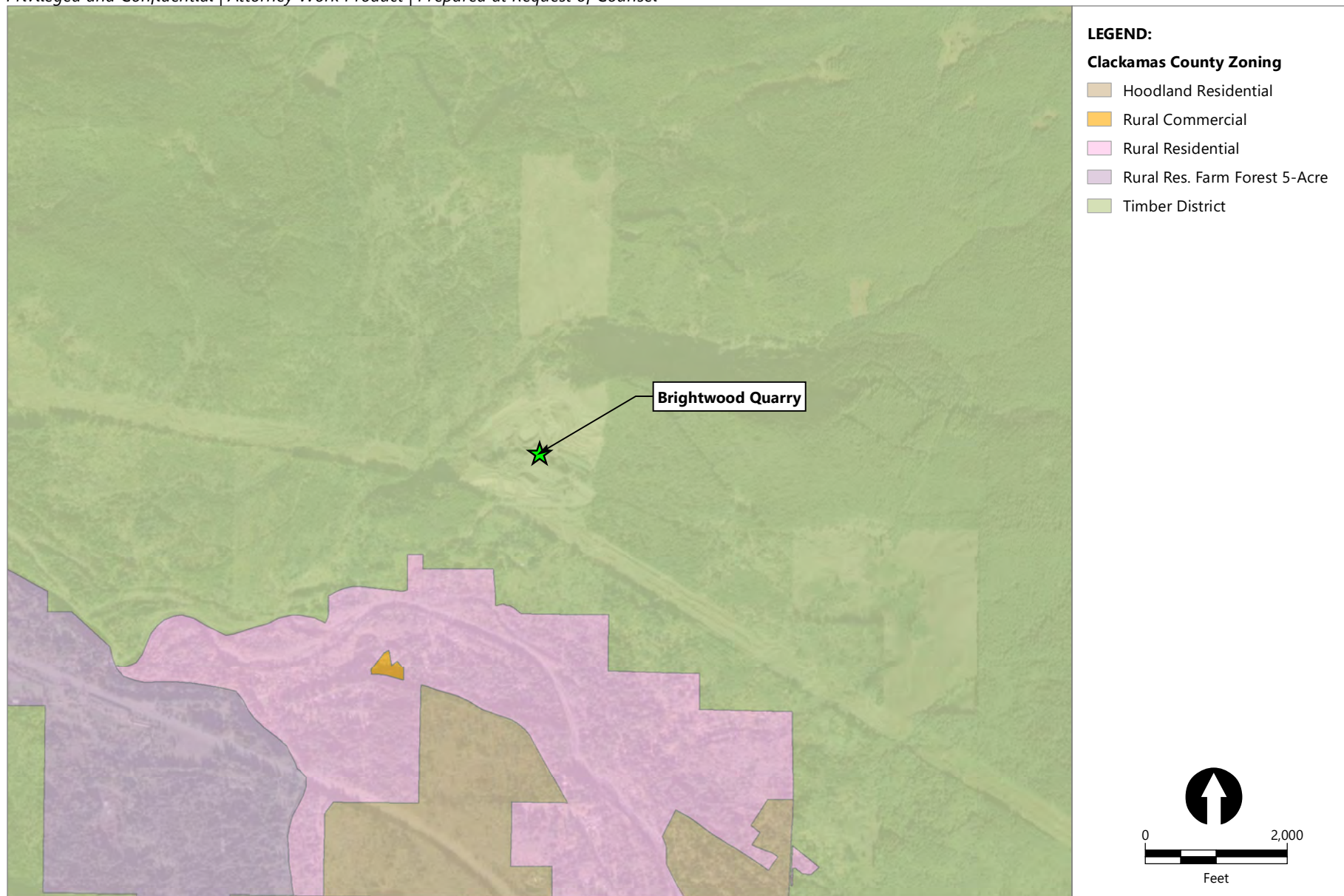
Figure 3
Watters Quarry Transportation
Joint Permit Application - Attachment H
Watters Quarry Phase II Project



Publish Date: 2024/01/05, 5:38 PM | User: jfox
Filepath: \\orcas\GIS\Jobs\Knife_River_Corp_2114\Watters_Quarry\Maps\JPA\AQ_JPA_AttachHFig4_Brightwood_TaxParcel.mxd



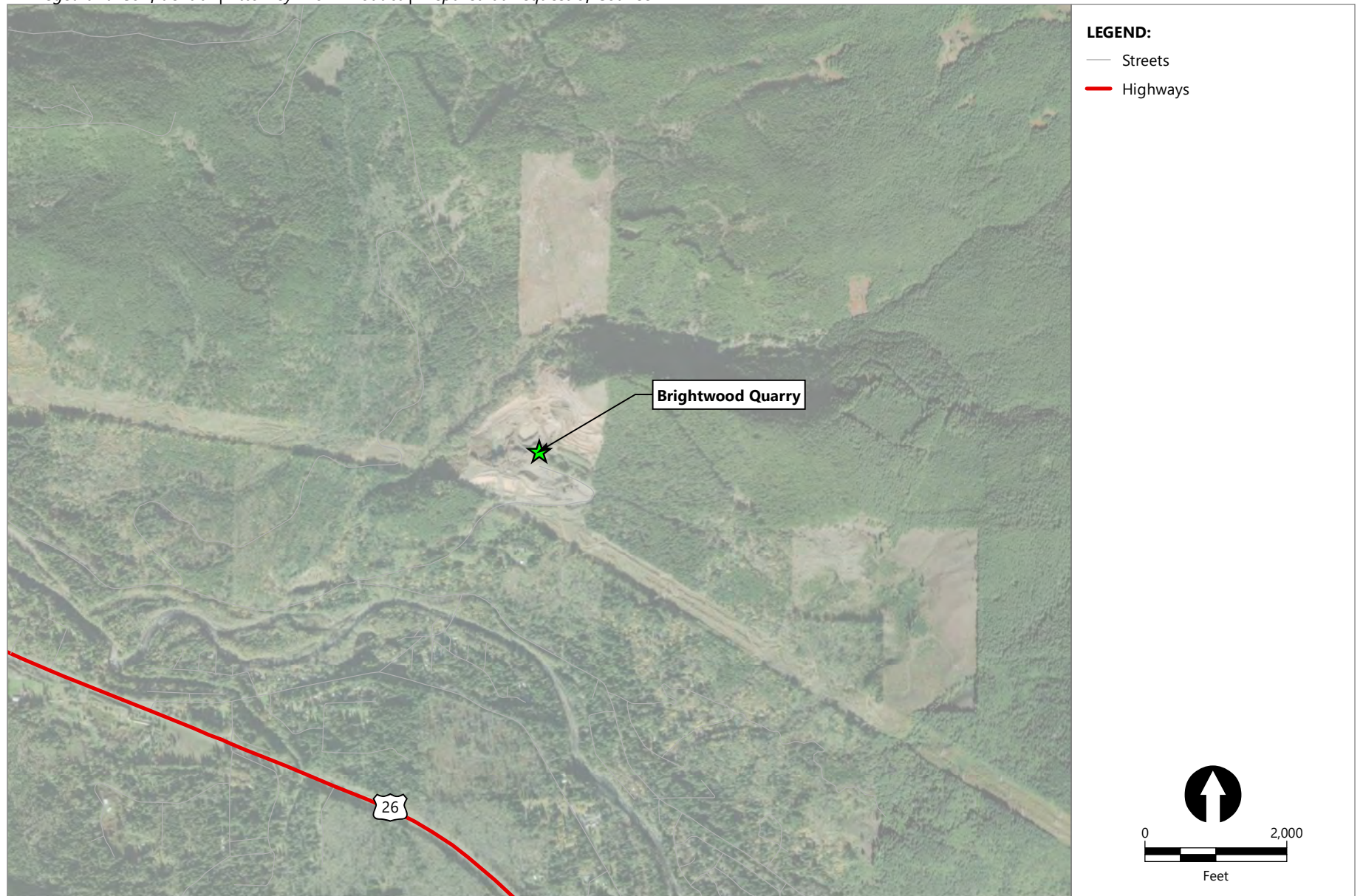
Figure 4
Brightwood Quarry Tax Parcel
Joint Permit Application - Attachment H
Watters Quarry Phase II Project



Publish Date: 2024/01/05, 5:39 PM | User: jfox
Filepath: \\orcas\GIS\Jobs\Knife_River_Corp_2114\Watters_Quarry\Maps\JPA\AQ_JPA_AttachHFig5_Brightwood_Zoning.mxd



Figure 5
Brightwood Quarry Zoning
Joint Permit Application - Attachment H
Watters Quarry Phase II Project

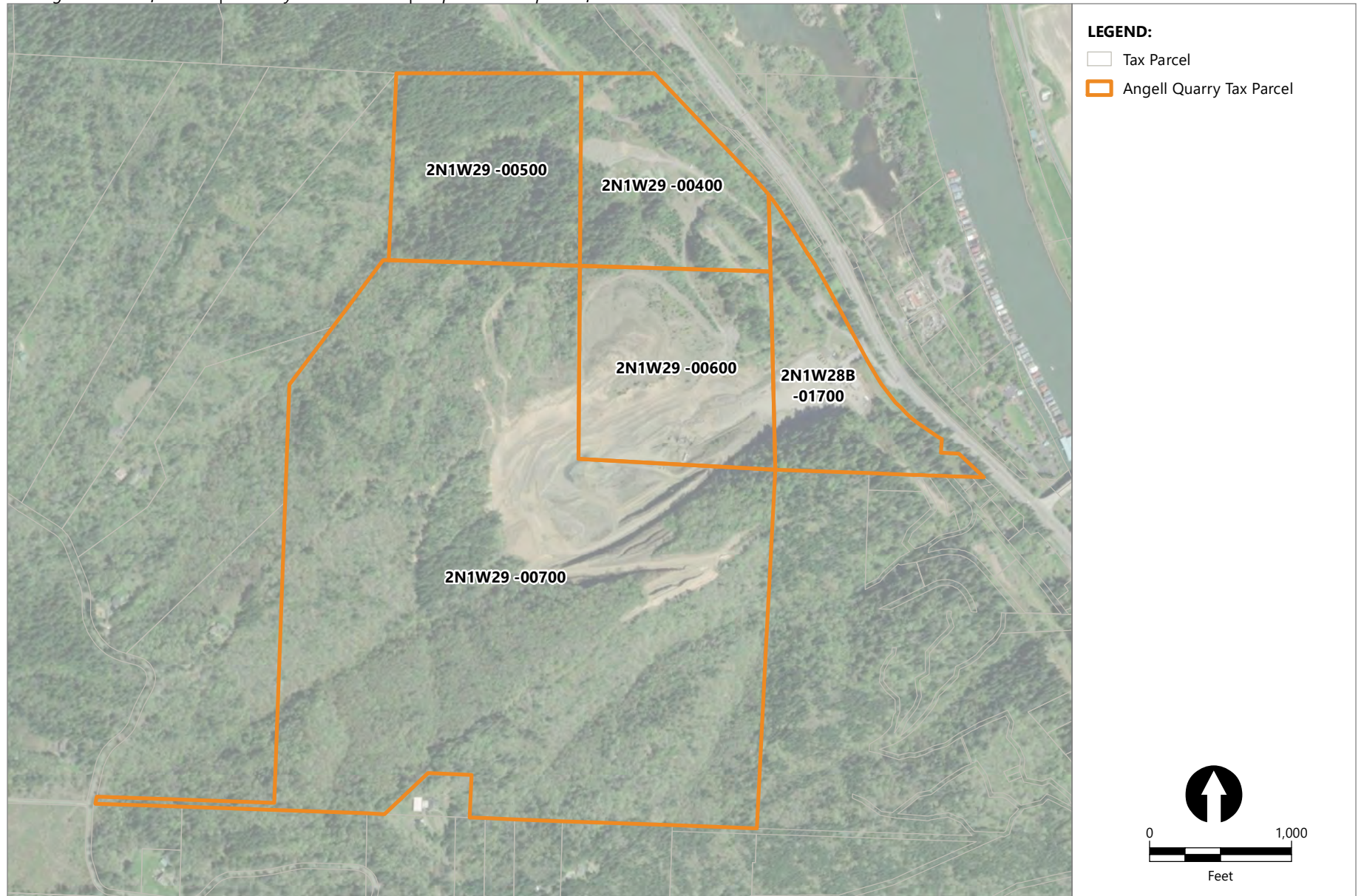


Publish Date: 2024/01/05, 5:40 PM | User: jfox
Filepath: \\orcas\GIS\Jobs\Knife_River_Corp_2114\Watters_Quarry\Maps\JPA\AQ_JPA_AttachHFig6_Brightwood_Transportation.mxd



Figure 6
Brightwood Quarry Transportation

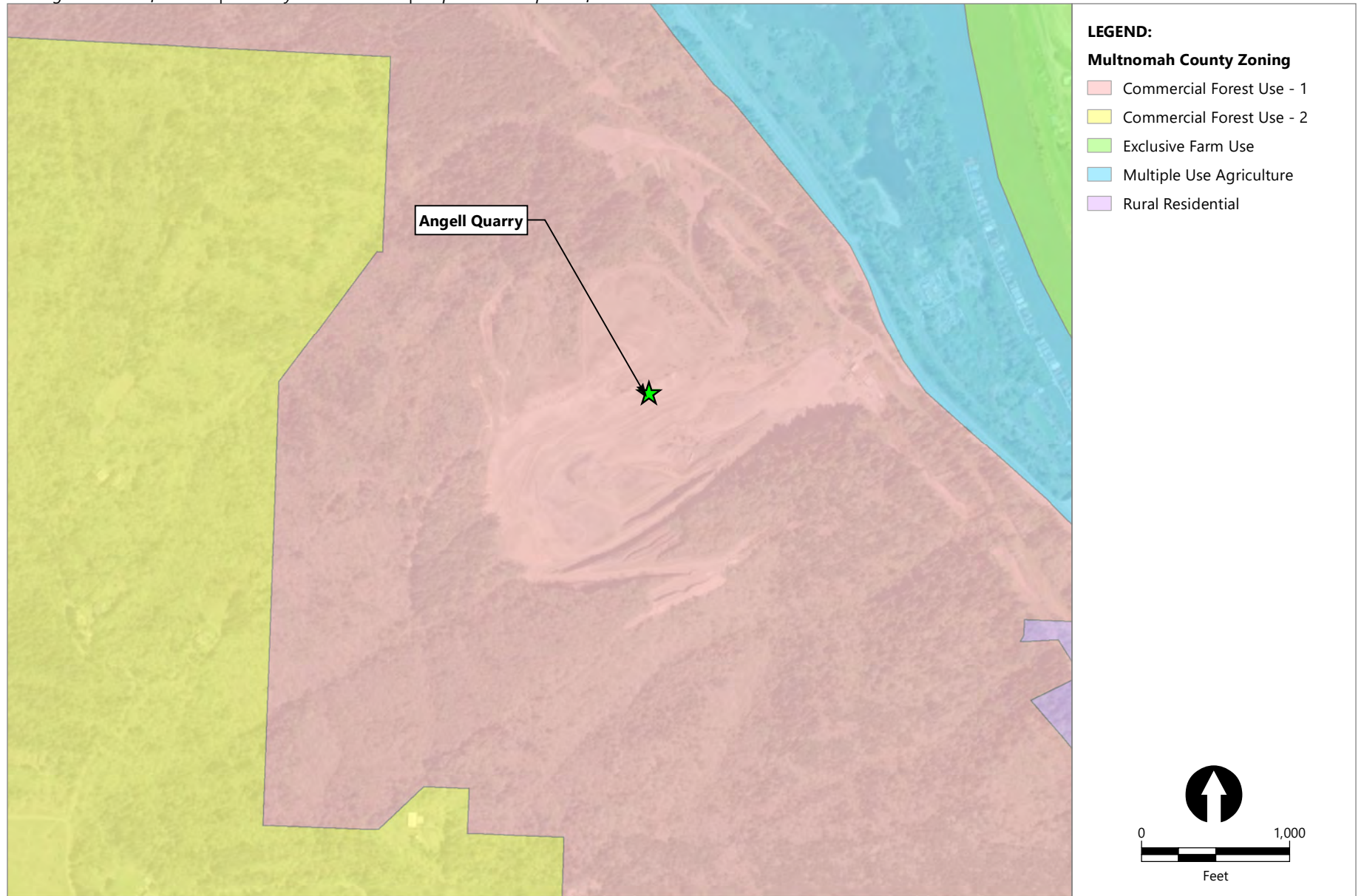
Joint Permit Application - Attachment H
Watters Quarry Phase II Project



Publish Date: 2024/01/05, 5:44 PM | User: jfox
Filepath: \\orcas\GIS\Jobs\Knife_River_Corp_2114\Watters_Quarry\Maps\JPA\AQ_JPA_AttachHFig7_Angell_TaxParcels.mxd



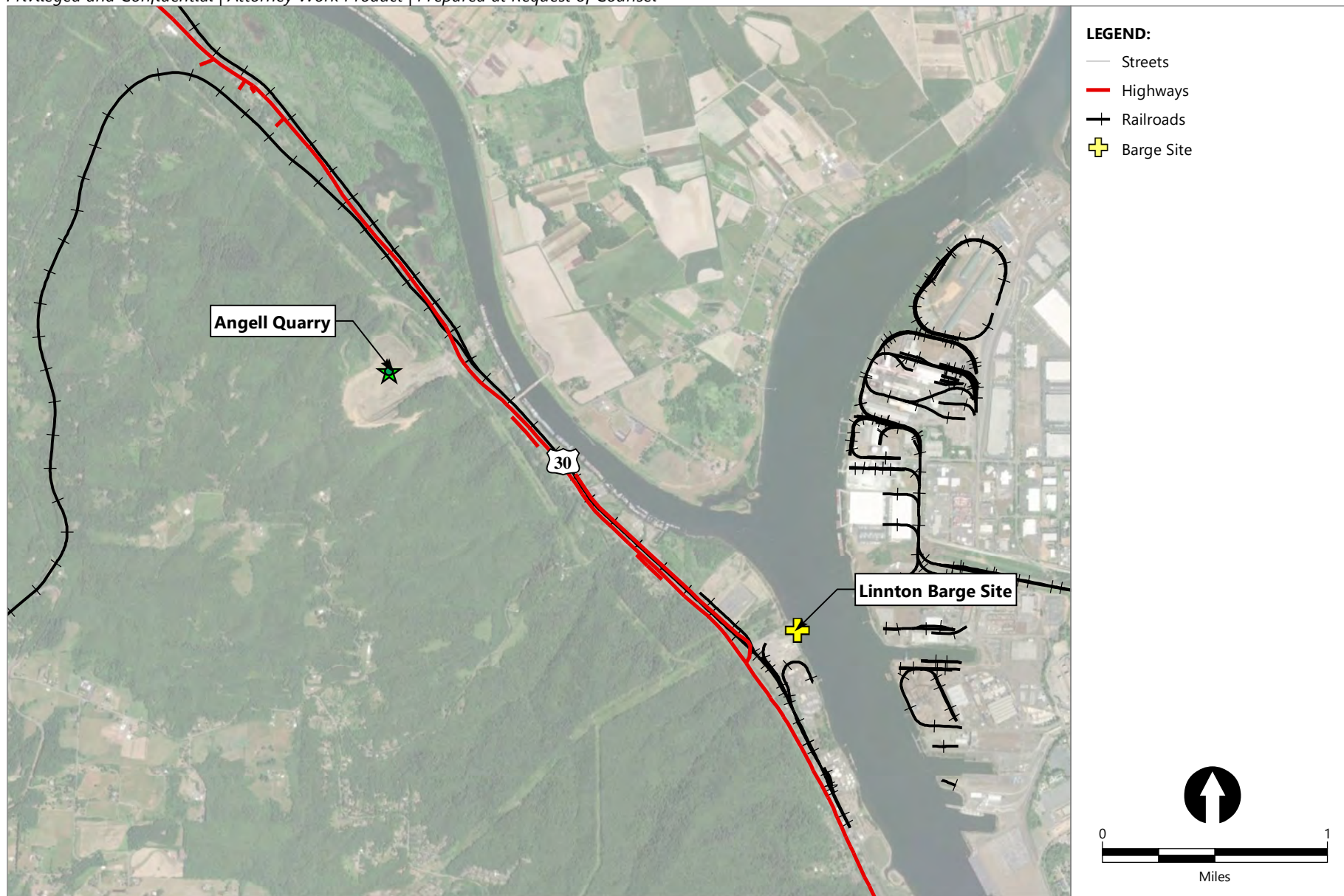
Figure 7
Angell Quarry Tax Parcels
Joint Permit Application - Attachment H
Watters Quarry Phase II Project



Publish Date: 2024/01/05, 5:44 PM | User: jfox
Filepath: \\orcas\GIS\Jobs\Knife_River_Corp_2114\Watters_Quarry\Maps\JPA\AQ_JPA_AttachHFig8_Angell_Zoning.mxd



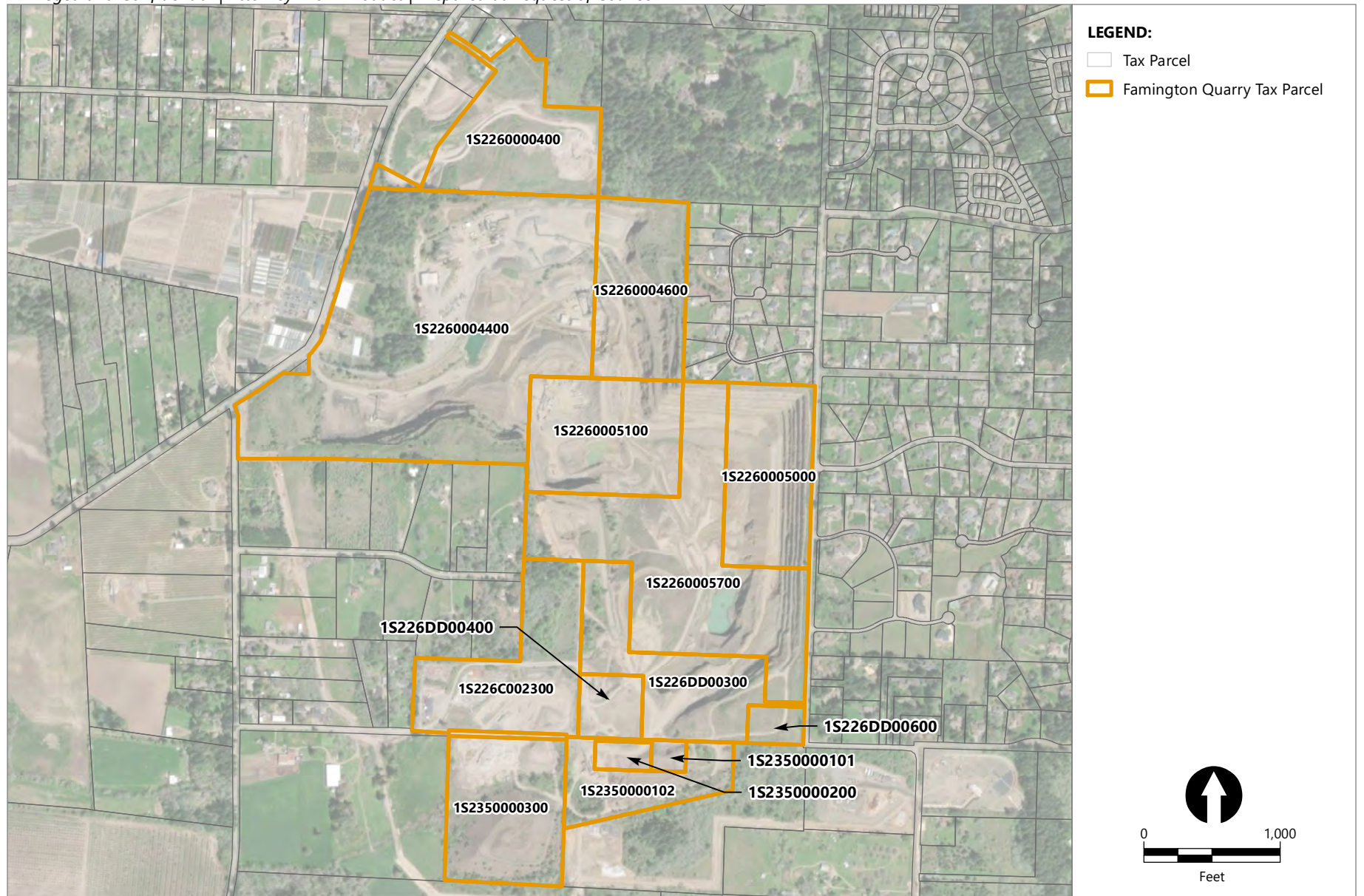
Figure 8
Angell Quarry Zoning
Joint Permit Application - Attachment H
Watters Quarry Phase II Project



Publish Date: 2024/01/05, 5:49 PM | User: jfox
Filepath: \\orcas\GIS\Jobs\Knife_River_Corp_2114\Watters_Quarry\Maps\JPA\AQ_JPA_AttachH\Fig9_Angell_Transportation.mxd



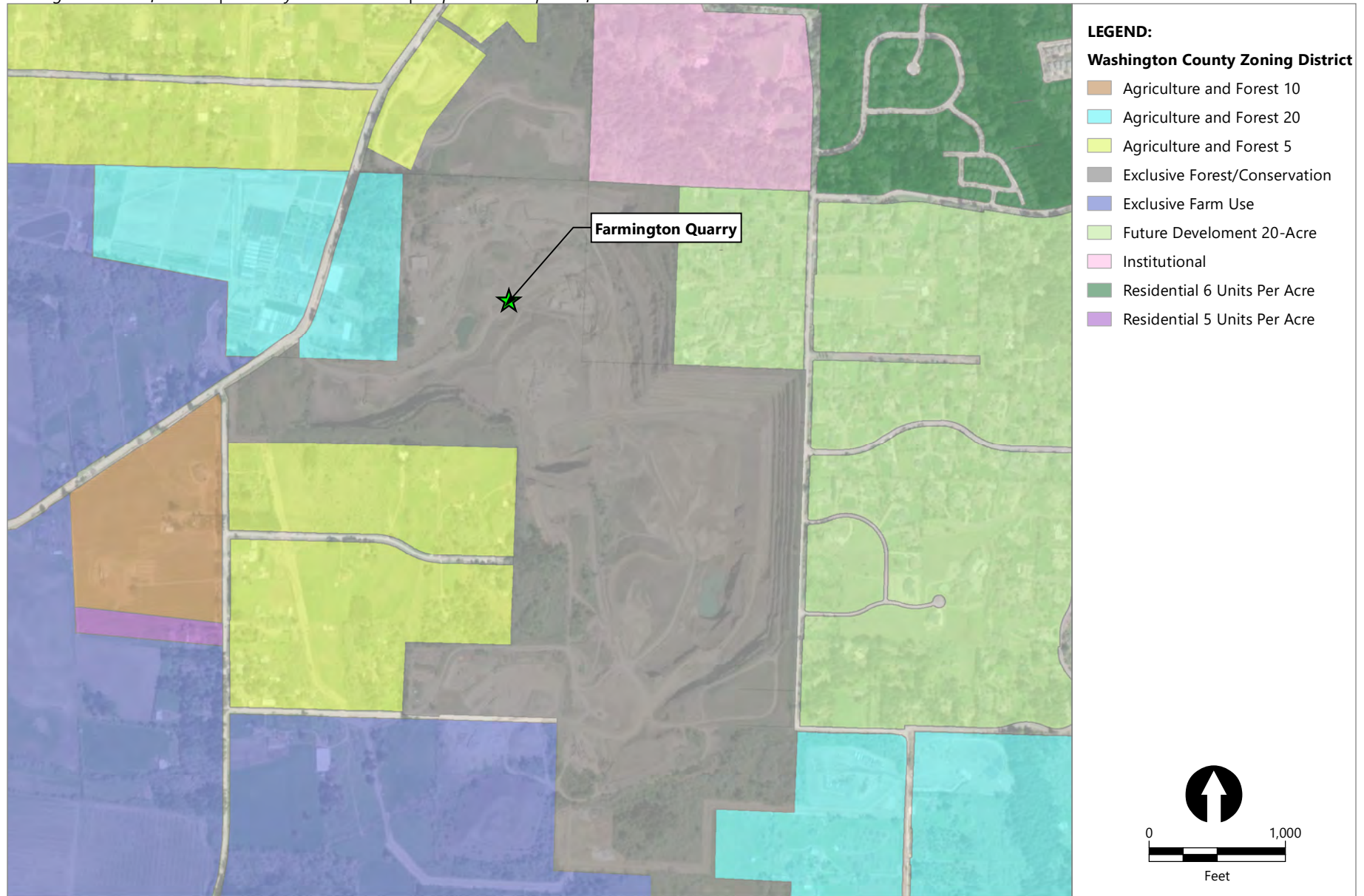
Figure 9
Angell Quarry Transportation
Joint Permit Application - Attachment H
Watters Quarry Phase II Project



Publish Date: 2024/01/05, 5:50 PM | User: jfox
Filepath: \\orcas\GIS\Jobs\Knife_River_Corp_2114\Watters_Quarry\Maps\JPA\AQ_JPA_AttachHFig10_Farmington_TaxParcels.mxd



Figure 10
Farmington Quarry Tax Parcels
Joint Permit Application - Attachment H
Watters Quarry Phase II Project



Publish Date: 2024/01/05, 5:51 PM | User: jfox
Filepath: \\orcas\GIS\Jobs\Knife_River_Corp_2114\Watters_Quarry\Maps\JPA\AQ_JPA_AttachHFig11_Farmington_Zoning.mxd



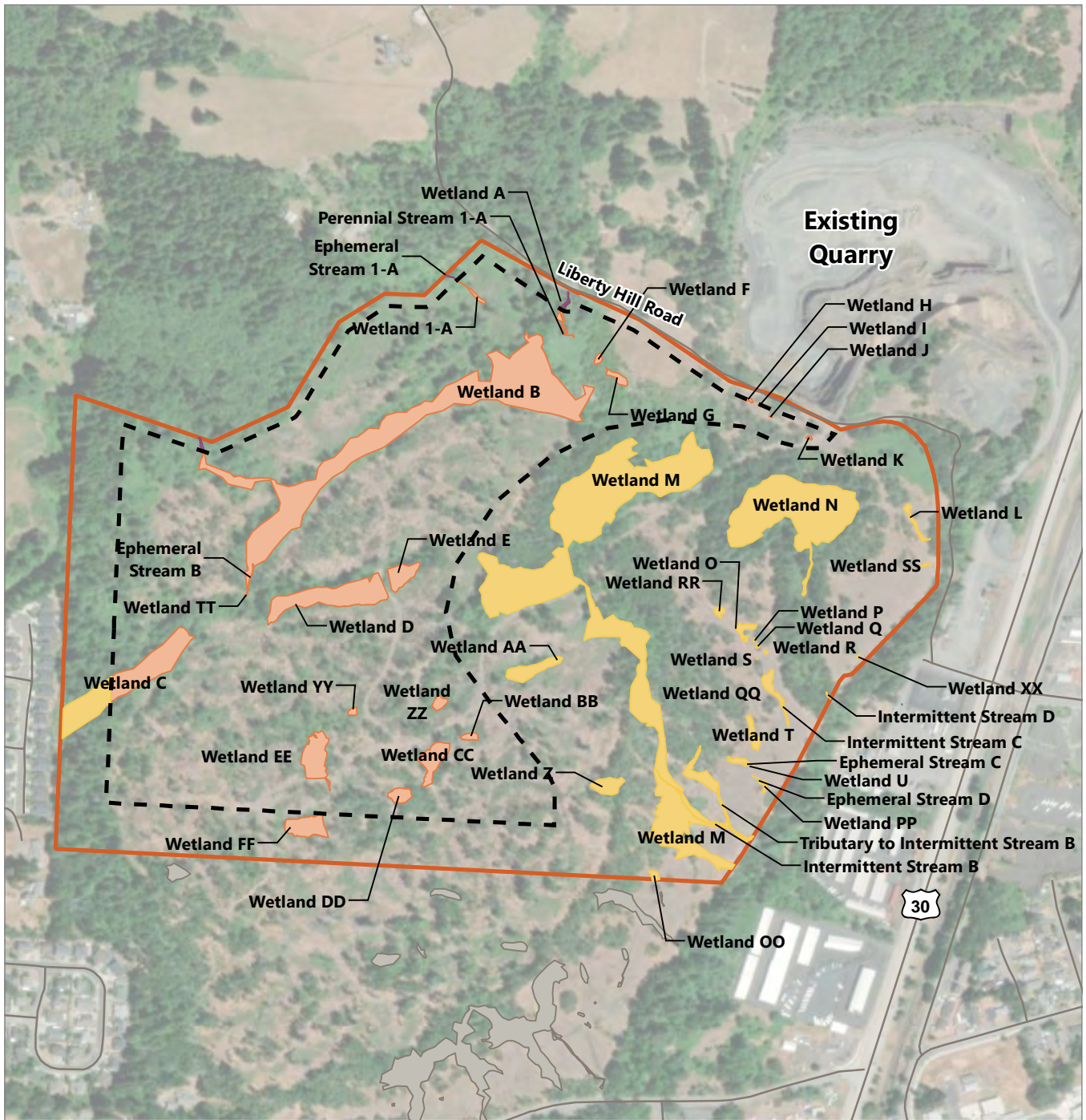
Figure 11
Farmington Quarry Zoning
Joint Permit Application - Attachment H
Watters Quarry Phase II Project



Publish Date: 2024/01/05, 5:53 PM | User: jfox
Filepath: \\orcas\GIS\Jobs\Knife_River_Corp_2114\Watters_Quarry\Maps\JPA\AQ_JPA_AttachHFig12_Farmington_Transportation.mxd



Figure 12
Farmington Quarry Transportation
Joint Permit Application - Attachment H
Watters Quarry Phase II Project



LEGEND:

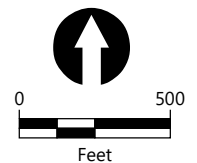
- Project Site
- Alternative 3 Mining Area

Alternative 3 Wetland and Stream Impacts

- Direct Impact
- Indirect Impact
- No Impact
- No Impact (Off Site)

NOTE:

- 1. Aerial imagery: Esri (2021)

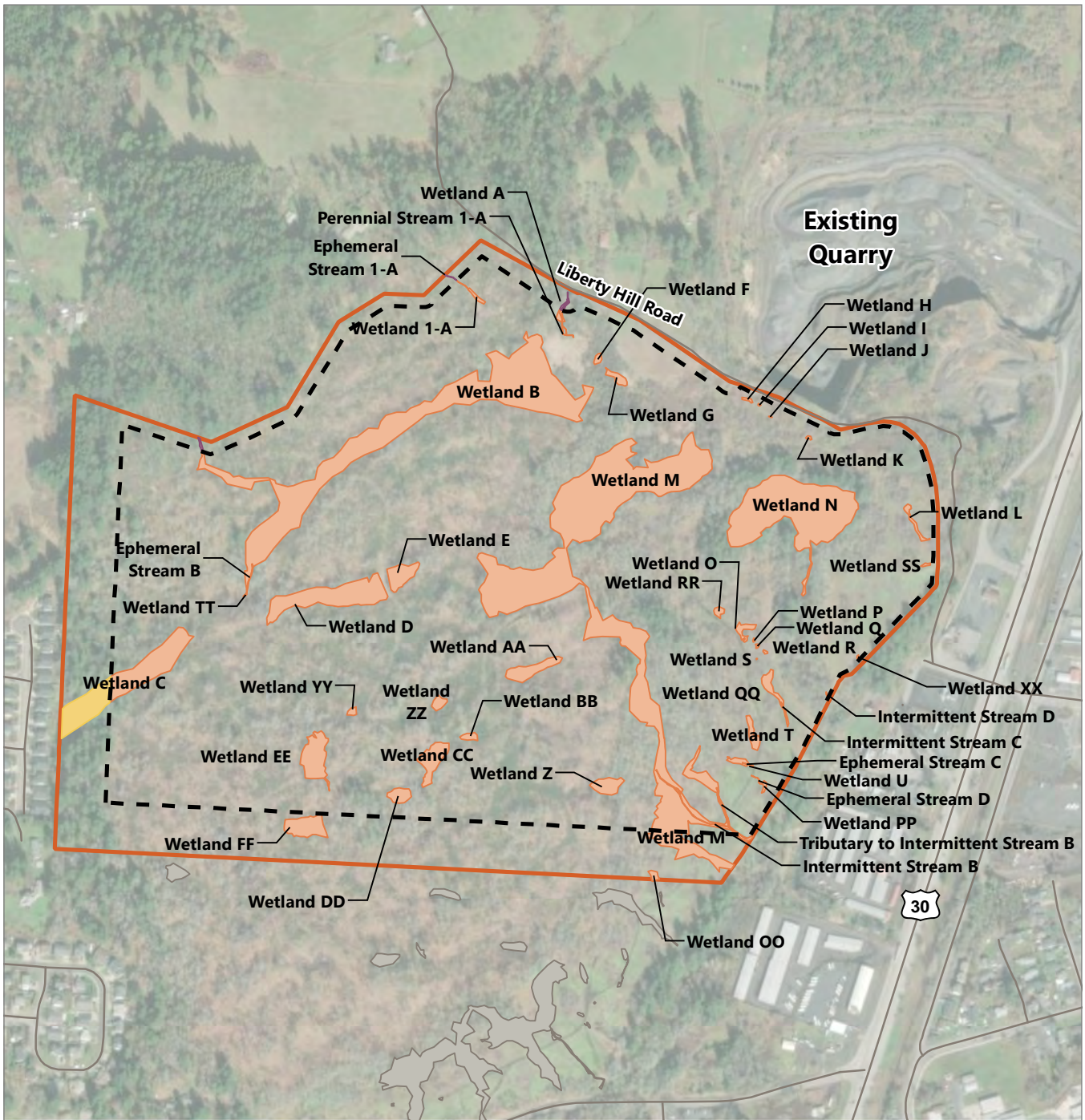


Publish Date: 2024/01/05, 5:56 PM | User: jfox
 Filepath: \\orcas\GIS\Jobs\Knife_River_Corp_2114\Watters_Quarry\Maps\JPA\AQ_JPA_AttachHFig13_Watters_OnSiteAlt3.mxd



Figure 13
Watters Quarry Phase II Project Alternative 3

Joint Permit Application - Attachment H
 Watters Quarry Phase II Project



LEGEND:

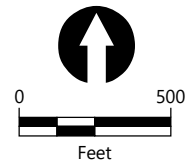
- Project Site
- Alternative 4 Mining Area

Alternative 4 Wetland and Stream Impacts

- Direct Impact
- Indirect Impact
- No Impact
- No Impact (Off Site)

NOTE:

- 1. Aerial imagery: Esri (2021)



Publish Date: 2024/03/29, 12:53 PM | User: jfox
 Filepath: \\orcas\GIS\Jobs\Knife_River_Corp_2114\Watters_Quarry\Maps\JPA\AQ_JPA_AttachHFig14_Watters_OnSiteAlt4.mxd



Figure 14
Watters Quarry Phase II Project Alternative 4

Joint Permit Application - Attachment H
 Watters Quarry Phase II Project

Appendix B

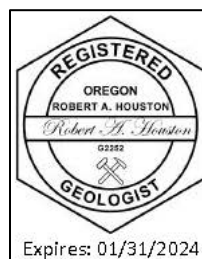
Geology and Resource Summary Report



Watters Quarry
Geology and Resource Report Summary
Columbia County, Oregon

October 13, 2023

By
Robert A. Houston¹
Registered Geologist - Oregon
G2252; Exp. 01/31/2024



¹Mining Geologist, Knife River Corporation – Northwest Region, 32260 Old Hwy 34, Tangent, Oregon, 97389

Watters Quarry: Geology and Resource Report Summary

Introduction:

The consequence of stratigraphy, rock jointing patterns, site geography and regional geologic events converged to create a unique exposure of high-quality geologic resource at the Watters Quarry, Columbia County, Oregon. The following describes the geologic resource at the Watters Quarry and includes a discussion with resource observations at comparative quarries.

Previous regional geologic investigations completed by Evarts (2002, 2004), Jenks et al. (2008), Ma et al. (2009a), Ma et al. (2009b), Wells et al. (2018, 2020) established the regional Cenozoic stratigraphic framework and distribution of geologic units. The Late Pleistocene, cataclysmic Missoula floods and their deposits were regionally described by Glenn (1965), Waitt (1994), O'Connor and others (2001), Benito and O'Connor (2003), Minervini and others (2003), Allen and others (2009) and Burns and Coe (2012). Site specific resource potential investigations of the Watters Quarry Phase-2 area was conducted by NV5 (Staley, 2021). KRC staff geologists Tim Marshall (2018) and Bob Houston (2022) conducted geologic reconnaissance of the property and reviewed drill core/chips samples.

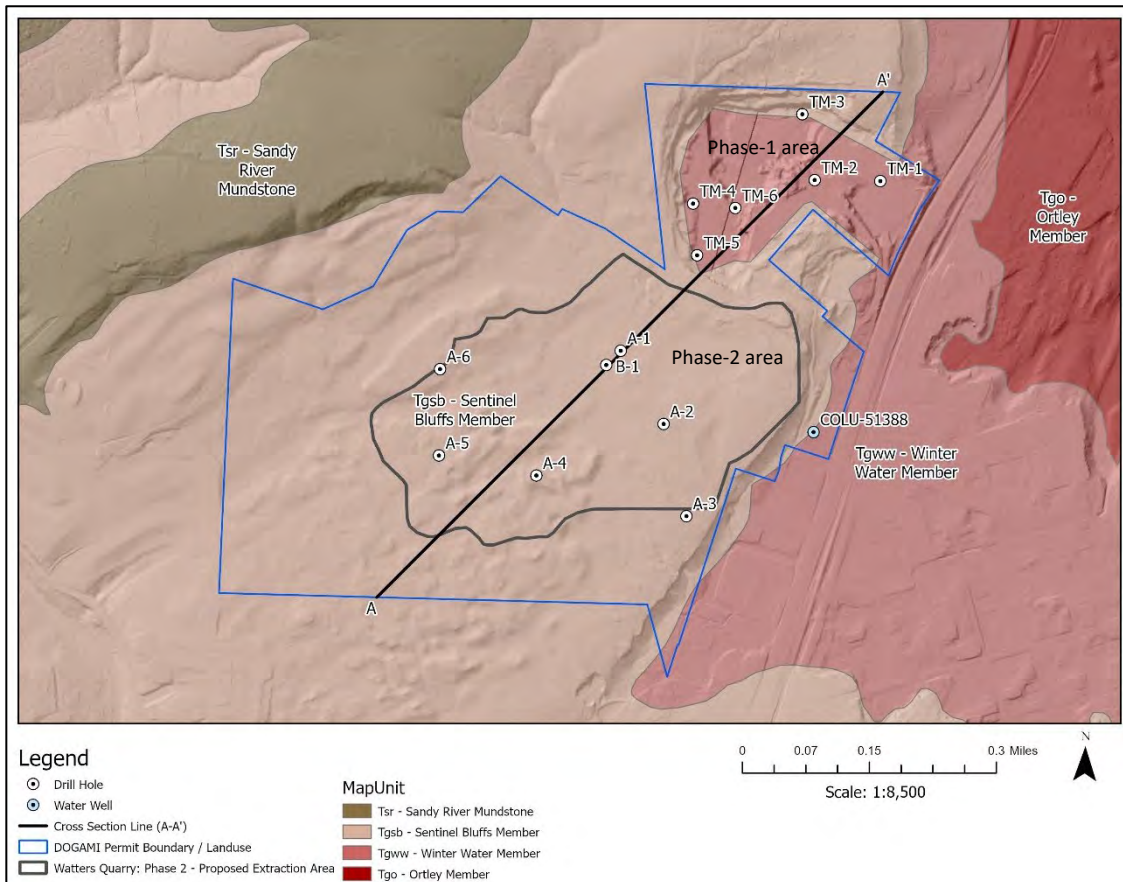


Figure 1: Tertiary Geologic Map, showing bedrock lithologies, drill locations and cross section line A-A' (Geology modified after Wells et al., 2018)

Geologic Resource Description:

A significant tonnage of high-quality basalt is exposed at the surface and includes the Sentinel Bluffs Member and the older Winter Water Member of the Grande Ronde Basalt (GRB) of the Columbia River Basalt Group. The Sentinel Bluffs Member and the Winter Water Member are the two geologic units that will be extracted in the Watters Quarry Phase1 and Phase-2 areas (Figure 1). In the Phase-1 area, the contact between the Winter Water Member and overlying Sentinel Bluff Member is exposed along the quarry highwall and marked by a zone of weathered flow breccia and reddish-brown clay. This contact is observed in the core hole B-1 at a depth of 82-ft bgs (157-ft MSL) in the Phase-2 area (Figure 1, Figure 2; Staley, 2021).

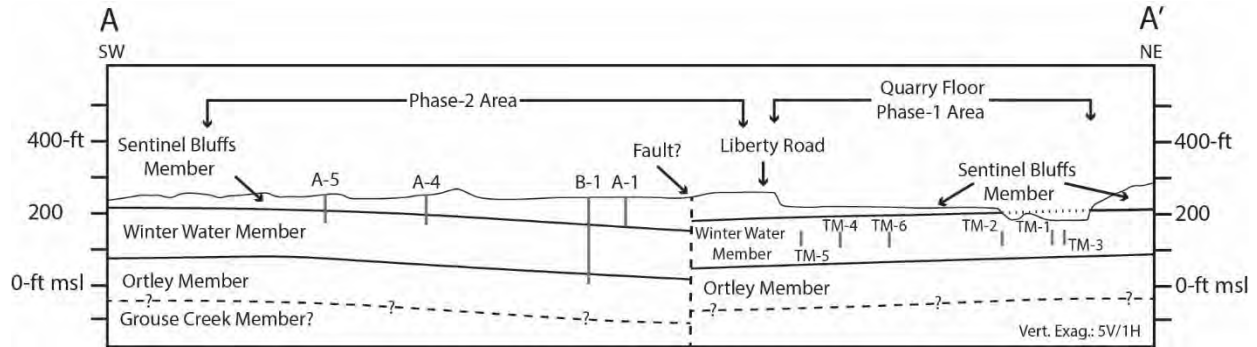


Figure 2: Geologic Cross Section - Watters Quarry (A – A’ cross section line located on Figure 1 above)

The basalt is generally gray to black-gray in color and fresh to slightly weathered. Most of the rock is aphanitic to finely vesicular. The basalt generally becomes vesicular in the flow top or bottom near the unit contact and along individual internal flow contacts, with up to 30 to 40 percent vesicles and vug. The colonnade and entablature jointing are evident (Figure 3A). The entablature exhibits a more irregular structure and is the dominate joint pattern exposed along the highwall in the Phase-1 area (Figure 3B). Greater decomposition of the bedrock and accumulation of clay and mineralization in the vesicles, vugs, and other pore spaces occurs along the individual flows within each member unit.

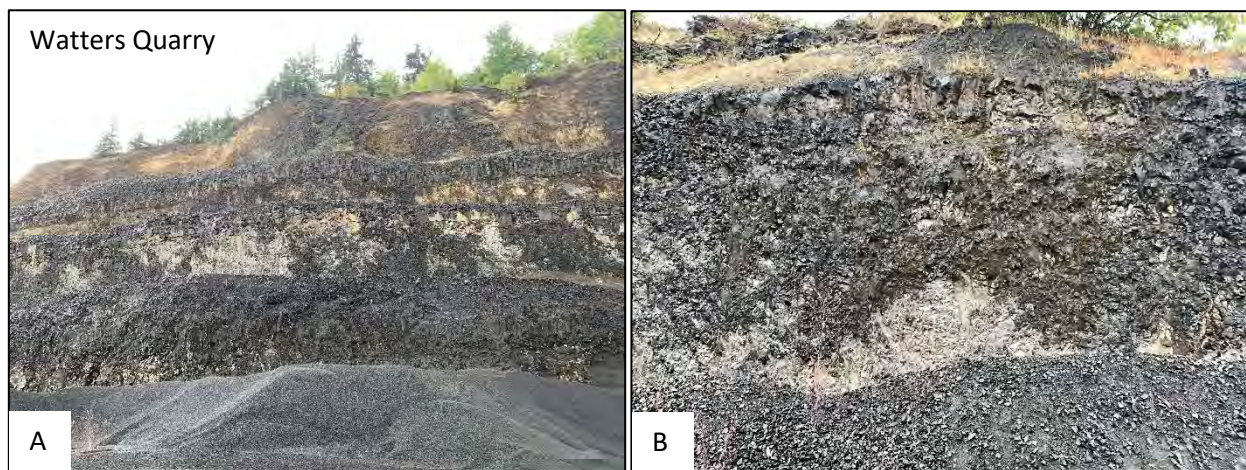


Figure 3: Watters Quarry Phase-1 highwall, showing the unique uniformity of the unit thickness, joint patterns, limited weathering, and quality.

Structurally, the basalt flows at Watters Quarry are very gently tilted (1 degree) southward in the active quarry area. South of the active quarry area, the depth to unit contacts observed in the drill holes, reveals that the basalt is tilted approximately 4 degrees to the north-northeast as a result of structural accommodation in the Phase-2 area.

Resource Quality:

At the Watters Quarry, the Sentinel Bluff member and Winter Water member thickness, fracture-density, fracture geometry, and quality parameters (Abrasion, Soundness, Degradation, Specific Gravity), are very consistent, as compared to other regional basalt flows. Based on extensive quality testing, the rock source meets and exceeds the restrictive quality standards as an ODOT ACP rock source (Wong, 2023 – Watters Quarry QC Data summary, 2023 and ODOT Lab reports).

Post-Depositional Geologic Events:

Following the period of regional deposition of aeolian loess deposits and chemical weathering of the basalt flows that created a thick layer of overburden (Exhibited at the Angell Quarry and other local rock sources), the Watters Quarry property was inundated and scoured by multiple glacial-outburst floods from Glacial Lake Missoula (i.e., the Missoula floods) over several glacial cycles. The most recent being about 15,500 to 13,000 years ago. The Watters Quarry is regionally located in a geographic area where the Columbia River is constricted by local topography, known as the “Kalama Gap”. At this location, the flow velocities likely increased as the turbulent flood waters swept across and scoured the property. Within the Phase 2 area, flood waters removed all soil, loess deposits, and weathered basalt, exposing the highest quality basaltic resource at surface.

Discussion: Spatial Variability in the Geologic Resource:

Both of the CRB basalt units exposed at the Watters Quarry (Sentinel Bluff member and Winter Water member; Figures 3A, 3B) are also exposed at Angell Quarry (Figure 4) and Farmington Quarry (Figure 6). However, at Angell Quarry and Farmington Quarry, these exposed units exhibit increased variability of internal individual flow thickness and discontinuity, vertically discontinuous joint and fracture patterns, multiple interflow autoclastic breccia horizons, clay seams and a higher degree of disseminated weathering of the rock than is observed at the Watters Quarry. In addition to similar increased lava flow thickness and textural variability, the exposed basalt at the Mtn. Hood Quarry (Figure 5) is significantly



Figure 4: Angell Quarry



Figure 5: Mtn. Hood Quarry

folded and faulted and has a higher degree of weathering, as compared to the other quarries. These differences in the physical and quality parameters of the resource resulted from local site-specific variations in the deposition of individual lava flows and cooling histories during emplacement as well as post-emplacement exhumation and physical and chemical weathering differences between at location. Together, these physical characteristics and site-specific geologic history have created a unique, thick, continuous, and uniform geologic resource of very high-quality basalt at the Watters Quarry not found in other basalt formation in the area.



Figure 6: Farmington Quarry

References:

- Allen, J.E., Burns, M., and Burns, S.F., 2009, Cataclysms on the Columbia, the great Missoula floods: Portland State University, Ooligan Press, 204 p.
- Burns, W. J., and Coe, D.E, 2012, Missoula floods—Inundation extent and primary flood features in the Portland metropolitan area, Clark, Cowlitz, and Skamania Counties., Washington, and Clackamas, Columbia, Marion, Multnomah, Washington, and Yamhill Counties, Oregon: Oregon Department of Geology and Mineral Industries map IMS-36, scale 1:8,200. Everts, R.C., 2002, Geologic map of the Deer Island quadrangle, Columbia County, Oregon, and Cowlitz County, Washington: U.S. Geological Survey Miscellaneous Field Studies Map 45 MF-2392, scale 1:24,000, pamphlet 45 p., and database, at <https://pubs.usgs.gov/mf/2002/2392/>.
- Everts, R.C., 2004, Geologic map of the Saint Helens quadrangle, Columbia County, Oregon, and Cowlitz and Clark Counties, Washington: U.S. Geological Survey Scientific Investigations Map 2834, scale 1:24,000, pamphlet 23 p., at <https://pubs.usgs.gov/sim/2004/2826/>.
- Glenn, J.L., 1965, Later Quaternary sedimentation and geological history of the north Willamette Valley, Oregon: Corvallis, Oregon, Oregon State University, Ph.D. dissertation, 231 p.
- Jenks, M.D., Wiley, T.J., Ferns, M.L., Staub, P.E., Ma, Lina, Madin, I.P., Niewendorp, C.A., Watzig, R.J., Taylor, E.M., and Mertzman, S.A., 2008, Oregon geologic data compilation, release 4 (southwest, central, southeast, northeast Oregon), Oregon Department of Geology and Mineral Industries, Digital Data Series OGDC-4, 1:100,000.

- Ma, L., Madin, I.P., Olson, K.V., Watzig, R.J., Wells, R.E., Niem, A.R., and Priest, G.R., 2009, Oregon geologic data compilation [OGDC], release 5 (statewide), Oregon Department of Geology and Mineral Industries, Digital Data Series OGDC-5, 1:100,000.
- Ma, L., Wells, R.E., Niem, A.R., Niewendorp, C.A., and Madin, I.P., 2009, Preliminary digital compilation map of part of northwestern Oregon, Oregon Department of Geology and Mineral Industries, Open-File Report O-09-03, 1:100,000.
- Marshall, Tim, 2018, Watters Quarry - Static Water Level Under the Current Mining Floor, Unpublished KRC staff report, p. 1.
- Staley, Erick, 2021, Mine Resource Evaluation Report Phase 2 Mine Area, Unpublished NV5 Report, p. 36.
- Minervini, J.J., O'Connor, J.E., and Wells, R.E., 2003, Maps showing inundation depths, ice-rafted erratics, and sedimentary facies of late Pleistocene Missoula floods in the Willamette Valley, Oregon: U.S. Geological Survey Open-File Report 03-408, scale 1:250,000.
- O'Connor, J.E., Sarna-Wojcicki, A., Wozniak, K.C., Pollette, P.J., and Fleck, R.J., 2001, Origin, extent, and thickness of Quaternary geologic units in the Willamette Valley, Oregon: U.S. Geological Survey Professional Paper 1620, 52 p.
- Waitt, R.B., Jr., 1994, Scores of gigantic, successively smaller Lake Missoula floods through channeled scabland and Columbia valley, *in* Swanson, D.A., and Haugerud, R.A., eds., *Geologic field trips in the Pacific Northwest*: Seattle, University of Washington Department of Geological Sciences, p. 1K1-1K88.
- Wells, R.E., Haugerud, R.A., Niem, A.R., Niem, W.A., Ma, Lina, Evarts, R.C., O'Connor, J.E., Madin, I.P., Sherrod, D.R., Beeson, M.H., Tolan, T.L., Wheeler, K.L., Hanson, W.B., and Sawlan, M.G., 2020, Geologic map of the greater Portland metropolitan area and surrounding region, Oregon and Washington, U.S. Geological Survey, Scientific Investigations Map SIM-3443, 1:63,360.

Attachment I

Photographs from Wetland Delineation Report and Memoranda

Appendix C

Study Area Photos (ground level)

5

5





Photo A (Figure 6A):

Looking north toward Wetland A and Sample Point (SP) 95 (wetland) and SP 96 (upland).

Photo taken on July 23, 2019.

Photo B (Figure 6A):

Looking southwest toward Wetland B.

Photo taken on February 7, 2018.



Project #6300

7/26/19



Pacific Habitat Services, Inc.
9450 SW Commerce Circle, Suite 180
Wilsonville, OR 97070

Photo documentation

Watters Quarry, St. Helen, Oregon



Photo C (Figure 6A):

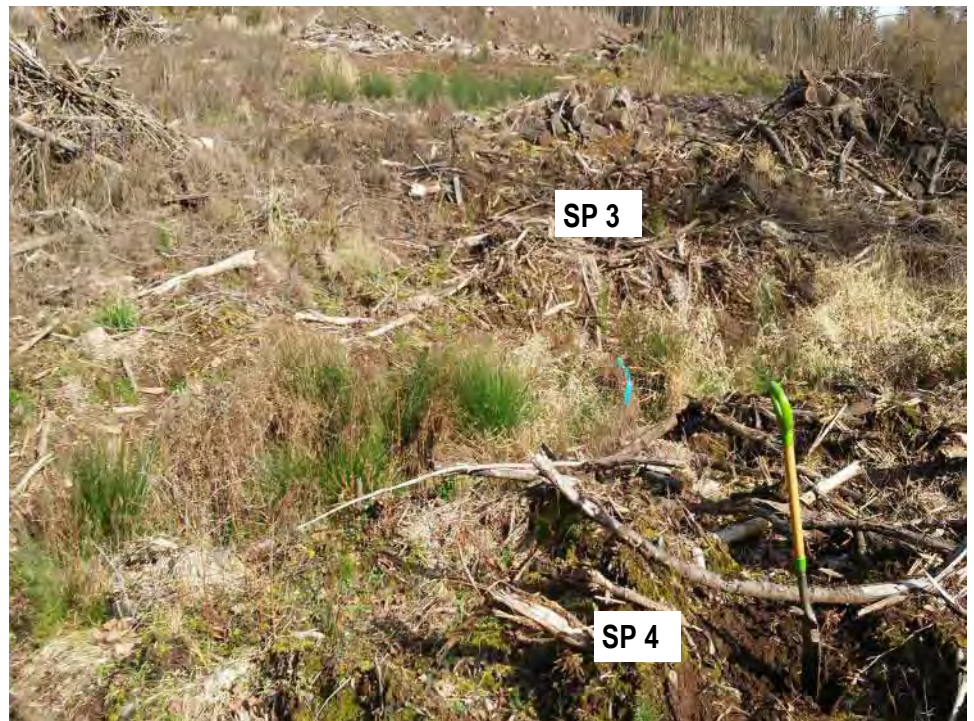
Looking east at Wetland B and SP 97 (wetland) and SP 98 (upland).

Photo taken on July 23, 2019.

Photo D (Figure 6A):

Looking northwest at Wetland B and SP 3 (wetland) and SP 4 (upland).

Photo taken on February 7, 2018.



Project #6300

7/26/19



Pacific Habitat Services, Inc.
9450 SW Commerce Circle, Suite 180
Wilsonville, OR 97070

Photo documentation
Watters Quarry, St. Helen, Oregon



Photo E (Figure 6A):

Looking north toward Wetland B and SP 99 and SP 100.

Photo taken on July 23, 2019.

Photo F (Figure 6A):

Looking northwest at upland area between Wetlands B and C. Dominant vegetation is snowberry (*Symphoricarpos alba*, FACU).

Photo taken on June 14, 2019.



Project #6300

7/26/19



Pacific Habitat Services, Inc.
9450 SW Commerce Circle, Suite 180
Wilsonville, OR 97070

Photo documentation
Watters Quarry, St. Helen, Oregon



Photo G (Figure 6A):

Looking south toward Wetland C and SP 81 (upland) and SP 82 (wetland).

Photo taken on June 14, 2019.

Photo H (Figure 6A):

Looking south at Wetland C and SP 5 (wetland) and SP 6 (upland).

Photo taken on February 7, 2019.



Project #6300

7/26/19



Pacific Habitat Services, Inc.
9450 SW Commerce Circle, Suite 180
Wilsonville, OR 97070

Photo documentation
Watters Quarry, St. Helen, Oregon



Photo I (Figure 6A):

Looking south toward Wetland D and SP 77 (wetland).

Photo taken on June 14, 2019.

Photo J (Figure 6A):

Looking east at Wetland E and SP 74 (upland) and SP 75 (wetland).

Photo taken on June 16, 2019.



Project #6300

7/2619



Pacific Habitat Services, Inc.
9450 SW Commerce Circle, Suite 180
Wilsonville, OR 97070

Photo documentation
Watters Quarry, St. Helen, Oregon



Photo K (Figure 6A):

Looking northeast toward
Wetland F and SP 71 (wetland)
and SP 72 (upland)

Photo taken on June 14, 2019.

Photo L (Figure 6A):

Looking northwest at Wetland G
and SP 67 (wetland) and SP 68
(upland).

Photo taken on June 14, 2019.



Project #6300

7/2619



Pacific Habitat Services, Inc.
9450 SW Commerce Circle, Suite 180
Wilsonville, OR 97070

Photo documentation

Watters Quarry, St. Helen, Oregon

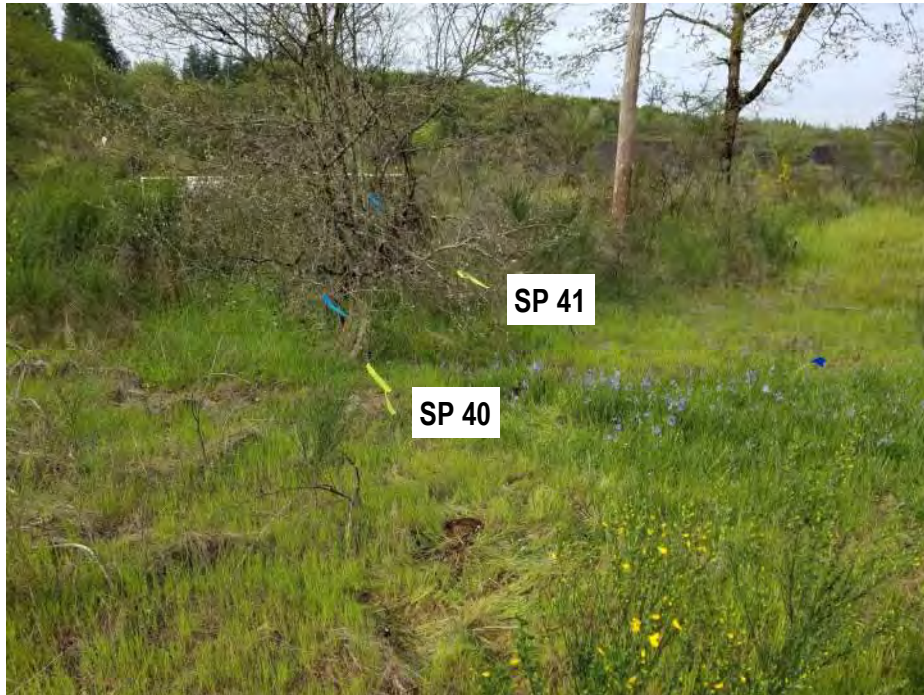


Photo M (Figure 6C):

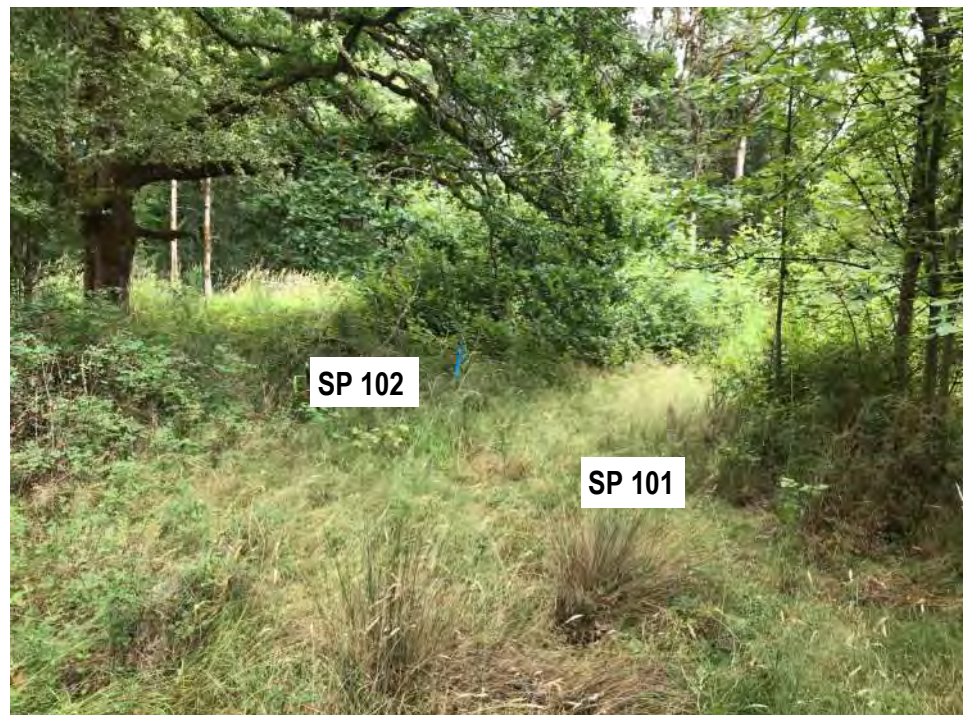
Looking north towards Wetland I and SP 40 (upland) and SP 41 (wetland).

Photo taken on April 25, 2019.

Photo N (Figure 6A):

Looking southeast at Wetland M's east boundary and SP 101 (wetland) and SP 102 (upland).

Photo taken on July 23, 2019.



Project #6300
7/2619



Pacific Habitat Services, Inc.
9450 SW Commerce Circle, Suite 180
Wilsonville, OR 97070

Photo documentation
Watters Quarry, St. Helen, Oregon



Photo O (Figure 6A):

Looking northeast towards
Wetland M and SP 33 (upland)
and SP 34 (wetland).

Photo taken on April 25, 2019.

Photo P (Figure 6A):

Looking northeast at
Wetland M and SP 103
(wetland) and SP 104 (upland).

Photo taken on July 23, 2019.



Project #6300

7/2619



Pacific Habitat Services, Inc.
9450 SW Commerce Circle, Suite 180
Wilsonville, OR 97070

Photo documentation
Watters Quarry, St. Helen, Oregon



Photo Q (Figure 6A):

Looking south at Wetland M, which in this area has flowing water during the rainy season and is approximately 50 percent vegetated during summer.

Photo taken on April 25, 2019.

Photo R (Figure 6A):

Looking northeast at the western boundary of Wetland M.

Photo taken on February 2, 2018.



Project #6300
7/2619



Pacific Habitat Services, Inc.
9450 SW Commerce Circle, Suite 180
Wilsonville, OR 97070

Photo documentation
Watters Quarry, St. Helen, Oregon



Photo S (Figure 6C):

Looking west at SP 35 (upland), which was placed in a swale downslope from Wetland N.

Photo taken on April 25, 2019.

Photo T (Figure 6C):

Looking northwest at SP 59 (Wetland P), 60 (upland), and 61 (Wetland O).

Photo taken on June 13, 2019.



Project #6300
7/2619



Pacific Habitat Services, Inc.
9450 SW Commerce Circle, Suite 180
Wilsonville, OR 97070

Photo documentation
Watters Quarry, St. Helen, Oregon



Photo U (Figure 6C):

Looking south at Wetland T and SP 28.

Photo taken on April 25, 2019.

Photo V (Figure 6B):

Looking west at Wetland W and SP 16 (upland) and SP 17 (Wetland).

Photo taken on April 25, 2019.



Project #6300
7/2619



Pacific Habitat Services, Inc.
9450 SW Commerce Circle, Suite 180
Wilsonville, OR 97070

Photo documentation
Watters Quarry, St. Helen, Oregon



Photo W (Figure 6B):
Looking north at Wetland W.
Photo taken on April 25, 2019.

Photo X (Figure 6B):
Looking northwest at Wetland X
and SP 84 (wetland) and SP 85
(upland).
Photo taken on June 23, 2019.



Project #6300
7/2619



Pacific Habitat Services, Inc.
9450 SW Commerce Circle, Suite 180
Wilsonville, OR 97070

Photo documentation
Watters Quarry, St. Helen, Oregon



Photo Y (Figure 6B)

Looking west at Wetland Y (northern portion) and SP 105 (wetland) and SP 106 (upland).

Photo taken on July 23, 2019.

Photo Z (Figure 6B):

Looking northwest at Wetland Y (western portion) and SP 88 (wetland) and SP 89 (upland).

Photo taken on June 23, 2019.



Project #6300

7/2619



Pacific Habitat Services, Inc.
9450 SW Commerce Circle, Suite 180
Wilsonville, OR 97070

Photo documentation
Watters Quarry, St. Helen, Oregon



Photo AA (Figure 6B):

Looking southwest at Wetland Y (western portion) and SP 109 (wetland) and SP 110 (upland).

Photo taken on July 23, 2019.

Photo BB (Figure 6B):

Looking southeast at Stream A and upland SP 107 and SP 108.

Photo taken on July 23, 2019.



Project #6300

7/2619



Pacific Habitat Services, Inc.
9450 SW Commerce Circle, Suite 180
Wilsonville, OR 97070

Photo documentation
Watters Quarry, St. Helen, Oregon



Photo CC (Figure 6B):

Looking southwest at Wetland Z and SP 111 (wetland) and SP 112 (upland).

Photo taken on July 23, 2019.

Photo DD (Figure 6A):

Looking south at Wetland AA and SP 91 (wetland) and SP 92 (upland).

Photo taken on June 23, 2019.



Project #6300
7/2619



Pacific Habitat Services, Inc.
9450 SW Commerce Circle, Suite 180
Wilsonville, OR 97070

Photo documentation
Watters Quarry, St. Helen, Oregon



Photo EE (Figure 6B):

Looking west at Wetland CC and SP 56.

Photo taken on April 25, 2019.

Photo FF (Figure 6A):

Looking southeast at Wetland EE and SP 47 (wetland) and SP 46 (upland).

Photo taken on May 3, 2019.



Project #6300
7/2619



Pacific Habitat Services, Inc.
9450 SW Commerce Circle, Suite 180
Wilsonville, OR 97070

Photo documentation
Watters Quarry, St. Helen, Oregon



Photo GG (Figure 6B):

Looking west at Wetland FF and SP 45.

Photo taken on May 3, 2019.

Photo HH (Figure 6B):

Looking northeast at Wetland GG and SP 63 (wetland) and SP 64 (upland).

Photo taken on June 13, 2019.



Project #6300

7/2619



Pacific Habitat Services, Inc.
9450 SW Commerce Circle, Suite 180
Wilsonville, OR 97070

Photo documentation
Watters Quarry, St. Helen, Oregon



Photo II (Figure 6B):

Looking north at SP 57, which lacked evidence of hydrophytic vegetation and hydric soils.

Photo taken on May 16, 2019.

Photo JJ (Figure 6B):

Looking northeast at SP 66, which lacked evidence of hydric soils and wetland hydrology.

Photo taken on June 13, 2019.



Project #6300

7/2619



Pacific Habitat Services, Inc.
9450 SW Commerce Circle, Suite 180
Wilsonville, OR 97070

Photo documentation
Watters Quarry, St. Helen, Oregon



P1: Perennial Stream 1-A, Looking Northeast



P2: Perennial Stream 1-A, Looking Southwest



P3: Ephemeral Stream 1-A



P4: Wetland 1-A, Looking Northwest

Filepath: \\FUJI\Portland\Projects\Knife River Corporation\Watters Quarry NR Permitting\Deliverables\404\11_Attachment_H_Site_Photos\WQ_WD_Memo_Photo_Appendix_P1-P4.docx

Attachment J

DSL WDR Concurrence Letter



Oregon

Kate Brown, Governor

Department of State Lands

775 Summer Street NE, Suite 100

Salem, OR 97301-1279

(503) 986-5200

FAX (503) 378-4844

www.oregon.gov/dsl

State Land Board

April 28, 2021

Weyerhaeuser
Attn: Mary Castle
220 Occidental Avenue South
Seattle, WA 98014

Kate Brown
Governor

Shemia Fagan
Secretary of State

Re: Revised WD # 2019-0623 **Approved with Revisions** (Revised)
Wetland Delineation Report for Watters Quarry, Columbia County;
Multiple Tax Maps and Tax Lots (see Attached Maps and Table)

Tobias Read
State Treasurer

Dear Ms. Castle:

The intent of this revised concurrence letter is to address additional wetlands and waterways that were identified after the original concurrence letter was issued. The additional wetlands and waters included one wetland (Wetland 1A) and 2 waterways (Perennial Stream 1A and Ephemeral Stream 1A). This revised concurrence replaces the letter, Wetland and Waters Summary Table 4, and Figure 6 and 6A through 6E from the original letter issued on October 15, 2020. Please replace the previous versions with the revised versions.

Within the study area after this update, 57 wetlands (Wetlands A through W, Y, Z, AA through HH, JJ through ZZ, AAA through FFF, and 1A) and 13 waterways (Perennial Stream 1-A, Intermittent Stream A through D, and Ephemeral Stream A through G and 1A) were identified. All the wetlands totaling approximately 22.12 acres (except Wetland K), Perennial Stream 1-A, and Intermittent Streams A through D, are subject to the permit requirements of the state Removal-Fill Law. Under current regulations, a state permit is required for cumulative fill or annual excavation of 50 cubic yards or more in wetlands or below the ordinary high-water line (OHWL) of the waterway (or the 2-year recurrence interval flood elevation if OHWL cannot be determined). The ephemeral streams and Wetland K are exempt per OAR 141-085-0515(3) & (6) respectively; therefore, these features are not subject to current state Removal-Fill requirements.

This concurrence is for purposes of the state Removal-Fill Law only. We recommend that you attach a copy of this concurrence letter to any subsequent state permit application to speed application review. Federal or local permit requirements may apply as well. The U.S. Army Corps of Engineers will determine jurisdiction under the Clean Water Act, which may require submittal of a complete Wetland Delineation Report.

Please be advised that state law establishes a preference for avoidance of wetland impacts. Because measures to avoid and minimize wetland impacts may include reconfiguring parcel layout and size or development design, we recommend that you work with Department staff on appropriate site design before completing the city or county land use approval process.

This concurrence is based on information provided to the agency. The jurisdictional determination is valid for five years from the date of the original letter, October 15, 2020, unless new information necessitates a revision. Circumstances under which the Department may change a determination are found in OAR 141-090-0045 (available on our web site or upon request). In addition, laws enacted by the legislature and/or rules adopted by the Department may result in a change in jurisdiction; individuals and applicants are subject to the regulations that are in effect at the time of the removal-fill activity or complete permit application. The applicant, landowner, or agent may submit a request for reconsideration of this determination in writing within six months of the date of this letter.

Thank you for having the site evaluated. If you have any questions, please contact the Jurisdiction Coordinator for Columbia County, Daniel Evans, PWS, at (503) 986-5271.

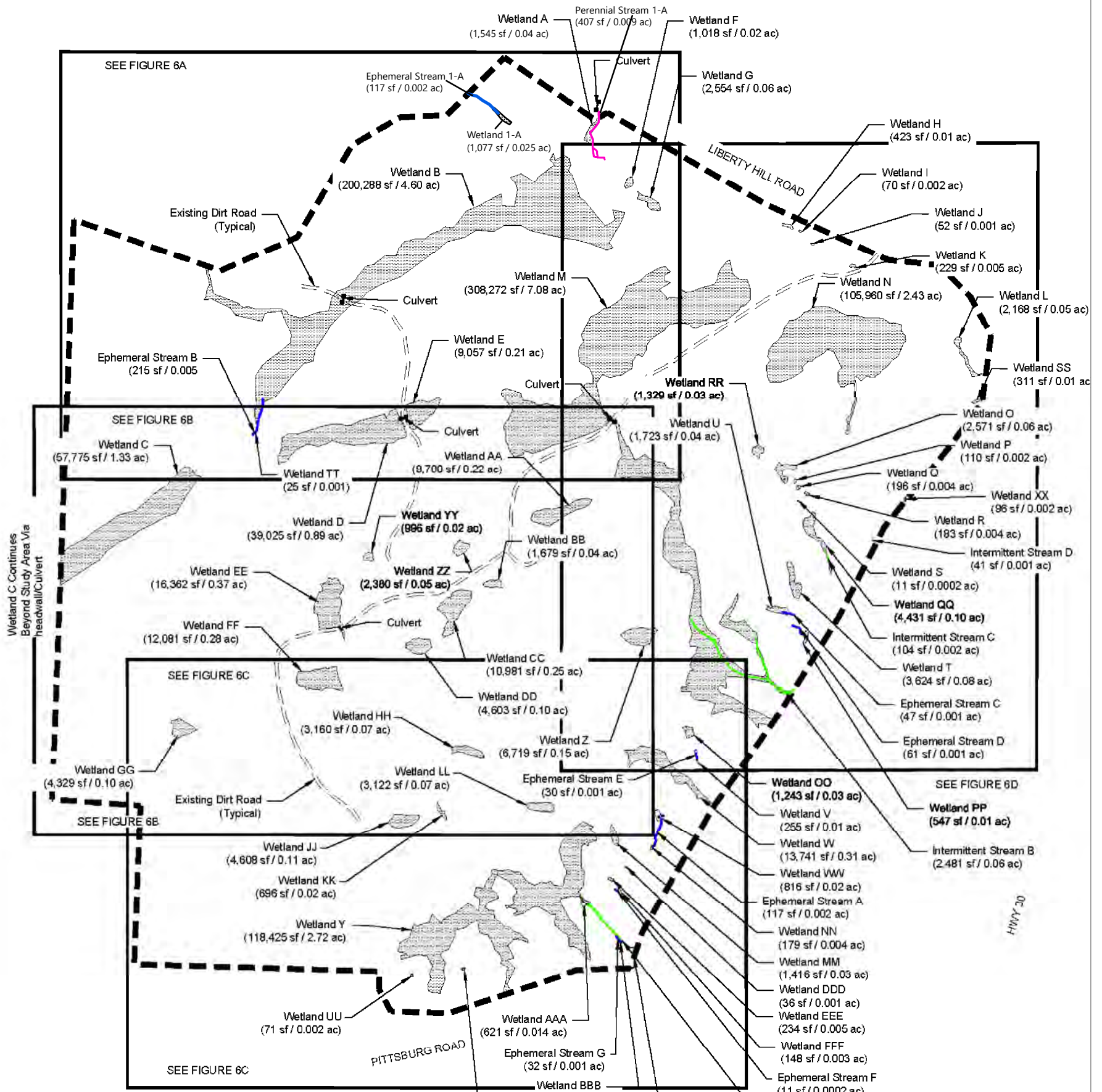
Sincerely,



Peter Ryan, SPWS
Aquatic Resource Specialist

Enclosures

ec: Marc Auten, PWS, Anchor QEA
Joe Thompson, PHS
Columbia County Planning Department
Caila Heintz, Corps of Engineers
Mike De Blasi, DSL
Joy Vaughan, ODFW



The following were surveyed by Udell Engineering and Land Surveying and have sub-centimeter accuracy: Wetlands A-E, H-Y, Sample Points 1-14, 17-26, 28-35, 37-39, 42, 43, 45, 47-56, 58-62, 65-67, 74-81, and 86-90.

The following were surveyed using a Trimble Geo7h and have submeter accuracy: Wetlands F, G, Z-GG and Sample Points 57, 68-73, 91-125, all ephemeral and intermittent streams, and all culverts.

The following were placed on the wetland delineation map by hand and are estimated to be submeter accurate: Sample Points 15, 16, 27, 36, 40, 41, 44, 46, 63, 64, 82-85.

The Study Area boundary was surveyed by Udell Engineering and Land Surveying and has sub-centimeter accuracy, with the exception of the southern portion of the boundary, which was hand-drawn in AutoCAD and verified in the field using a Thales Mobile Mapper CE GPS unit and has submeter accuracy.

The dirt access roads were digitized from a Google Earth aerial image in GIS and are estimated to have submeter accuracy.

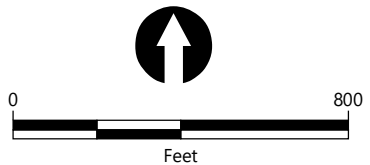
The following were surveyed using a Trimble GeoXh GPS unit and are sub-meter accurate: Sample Points SP1-SP4, Wetland 1-A, Ephemeral Stream 1-A, and Perennial Stream 1-A

LEGEND

- Study Area Boundary (9,061,982 sf / 208 ac)
- Wetland Site Total (963,680 sf / 22.12 ac)
- Intermittent Stream Waters of the State/US (3,803 sf / 0.09 ac)
- Ephemeral Stream
- Roads

NOTE: See Figures 6A-6C for location of sample points and photo points.

Stream A and Wetlands M, W, and Y Continue Beyond the Study Area to the Southeast.

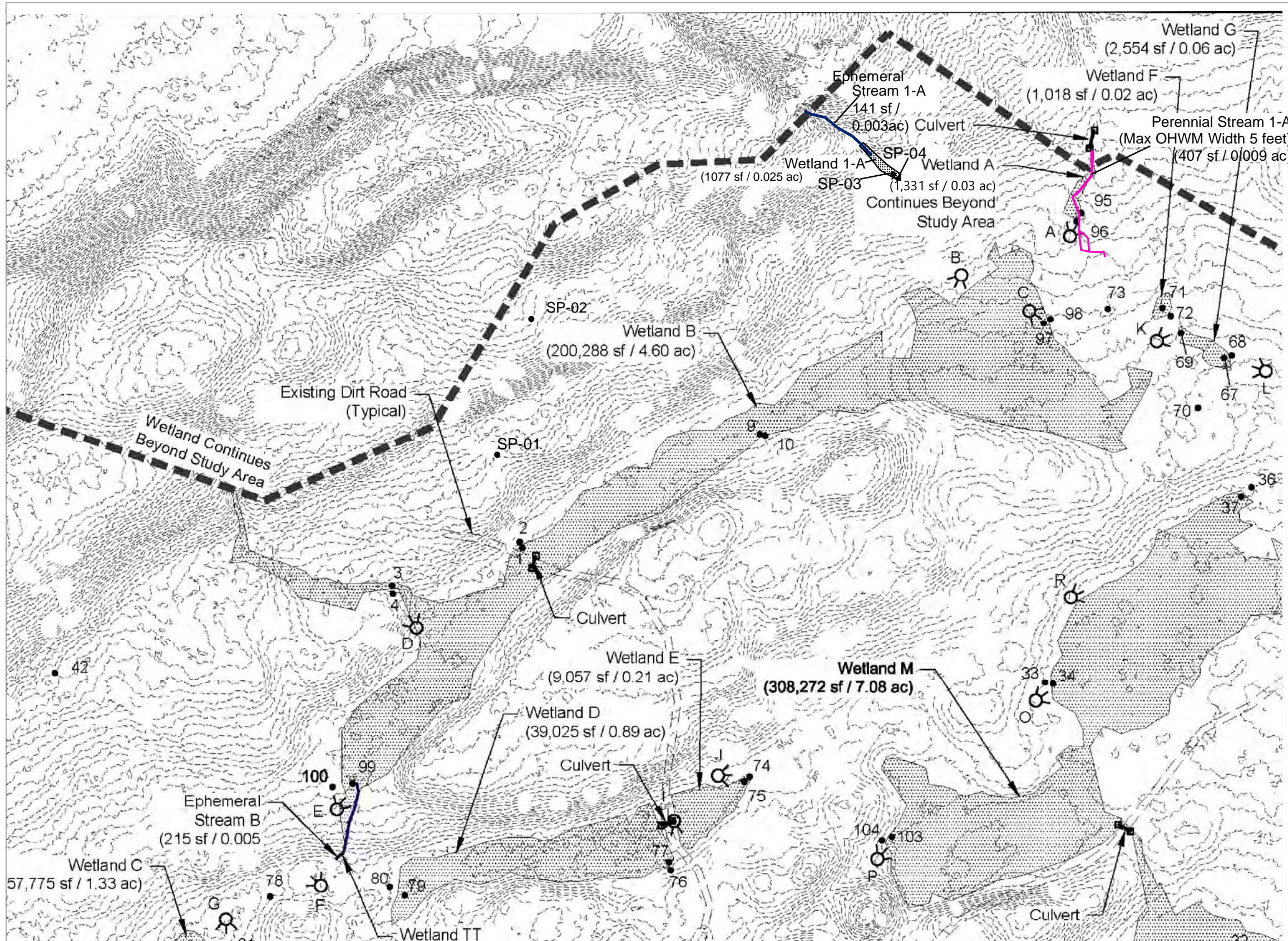


Perennial Stream 1-A (407 sf / 0.009 ac)

DSL WD # 2019-0623
Approval Revised 4/28/2021
Approval Expires 10/15/2025



Figure 6
Wetland Delineation Overview and Sheet Index
 Watters Quarry Expansion Project Wetland Delineation Addendum



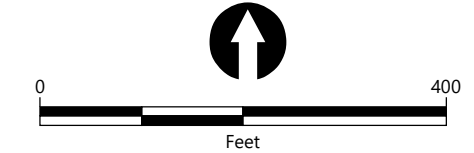
LEGEND

- Study Area Boundary (9,061,982 sf / 208 ac)
- Wetland Site Total (963,873 sf / 22.1 ac)
- Sample Point
- Photo Point
- Culvert
- Existing Contour (LiDAR 2 Foot Interval)
- Intermittent Stream Waters of the State/US (3,803 sf / 0.09 ac)
- Ephemeral Stream
- Roads
- Perennial Stream 1-A (407 sf / 0.009 ac)

NOTES:
 The following were surveyed using a Trimble GeoXh GPS unit and are sub-meter accurate: Sample Points 57, 58, 68-73, 85, 91-94, 107-125, and SP-1-SP-4, Wetlands F, G, Z, AA-FFF, and 1-A, Ephemeral Streams A-G and 1-A, Intermittent Streams A-D, Perennial Stream 1-A and all culverts

The following were hand-drawn onto a field map and are estimated to be +/- one meter accurate: Sample Points 15, 16, 27, 36, 40, 41, 44, 46, 63, 64, 82, 83, and 84.

The study area boundary was surveyed and is sub-centimeter accurate, with the exception of the southern boundary, which was hand-drawn in AutoCAD and is estimated to be accurate

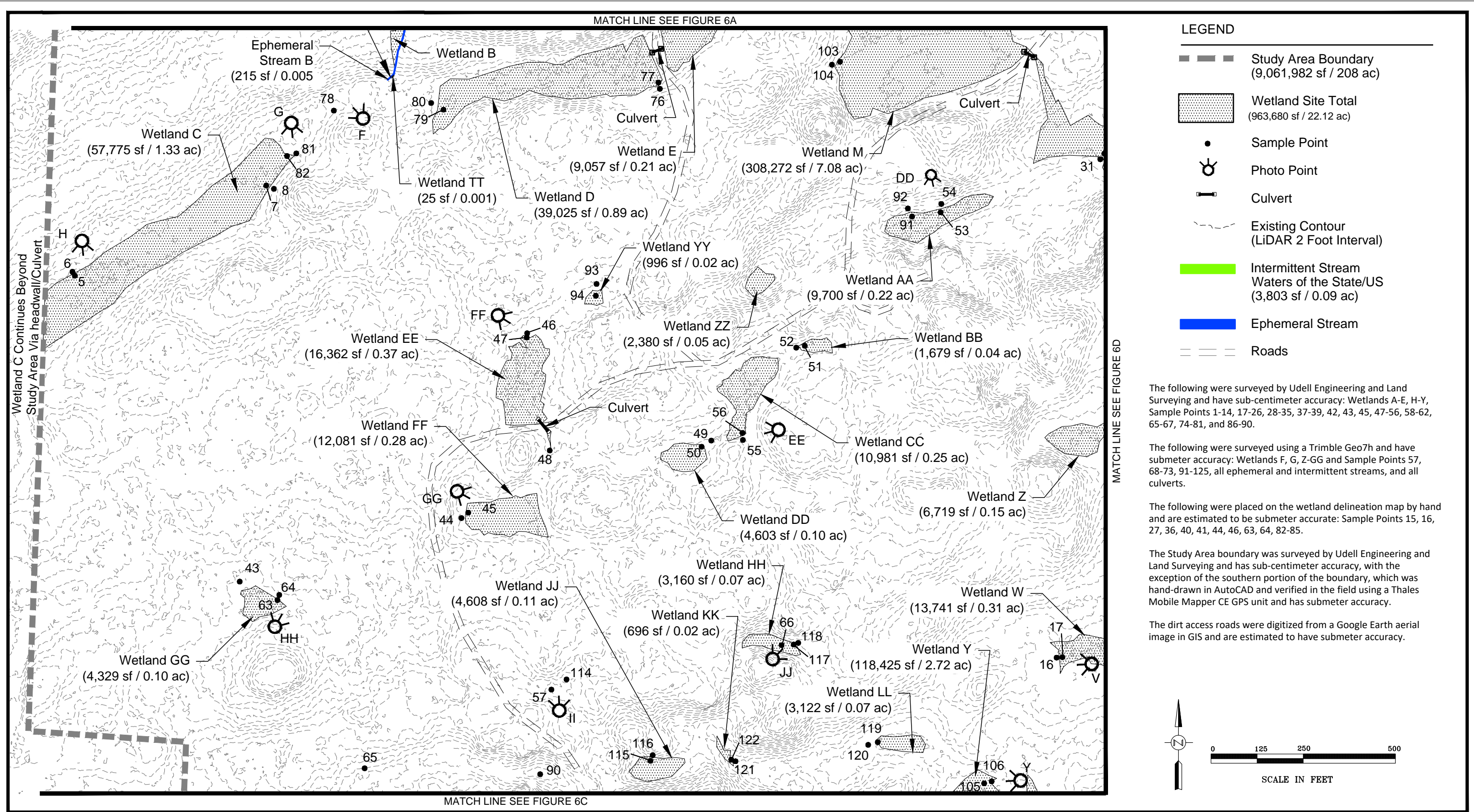


Publish Date: 2021/04/13, 12:14 PM | User: mauten
 Filepath: Q:\Jobs\Knife_River_Corp_2114\Watters_Quarry\Maps\Additional_Wetland_Work_202103\0421_Resubmittal\AQ_fig6a_Wetland_Delineation.mxd



DSL WD # 2019-0623
 Approval Revised 4/28/2021
 Approval Expires 10/15/2025

Figure 6A
Wetland Delineation
 Watters Quarry Expansion Project Wetland Delineation Addendum

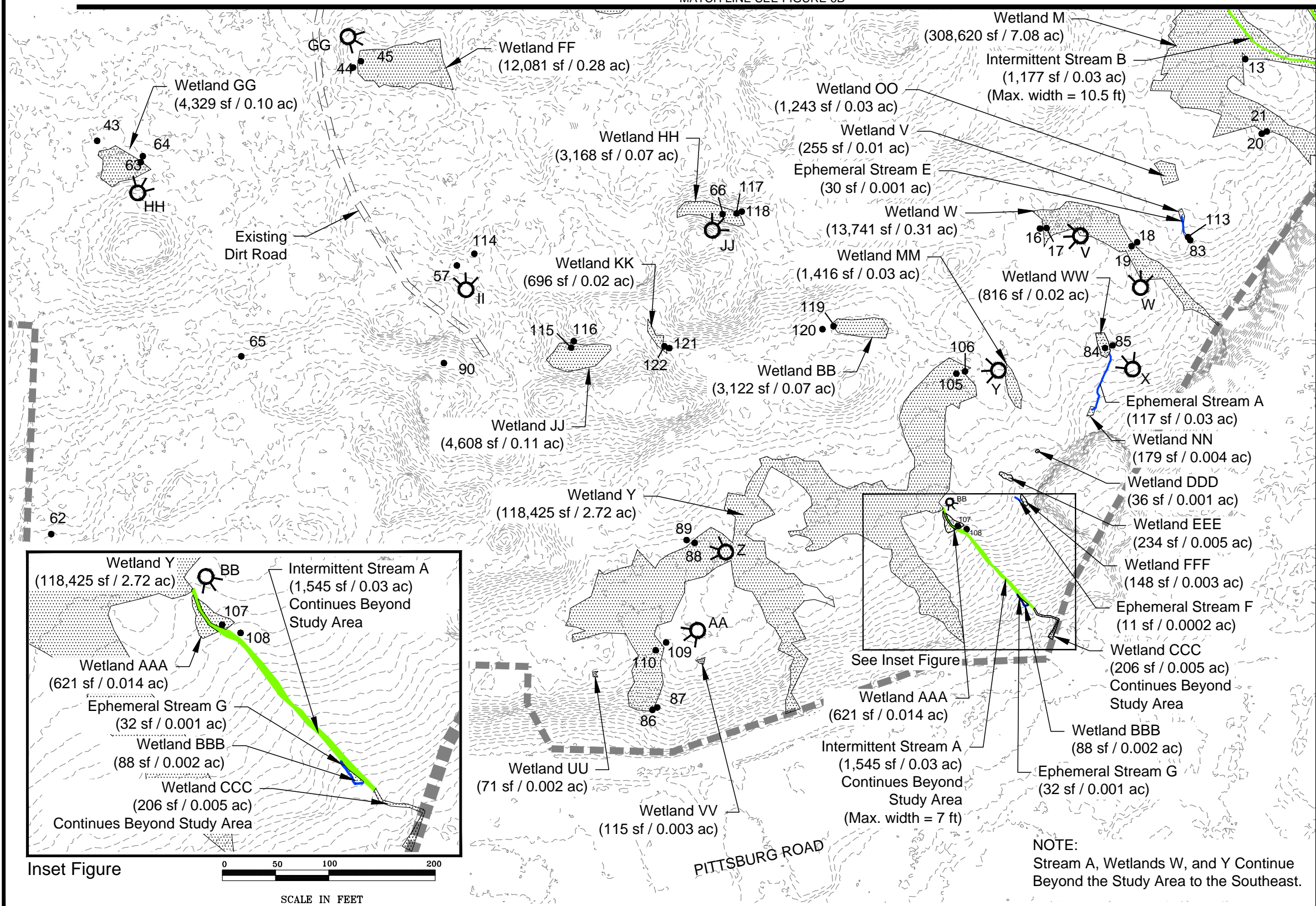


DSL WD # 2019-0623
Approval Revised 4/28/2021
Approval Expires 10/15/2025

Wetland Delineation
Watters Quarry - Saint Helens, Oregon
FIGURE 6B

10-1-2020

MATCH LINE SEE FIGURE 6B



LEGEND

- Study Area Boundary (9,061,982 sf / 208 ac)
- Wetland Site Total (963,680 sf / 22.12 ac)
- Sample Point
- Photo Point
- Culvert
- Existing Contour (LiDAR 2 Foot Interval)
- Intermittent Stream Waters of the State/US (3,803 sf / 0.09 ac)
- Ephemeral Stream
- Roads

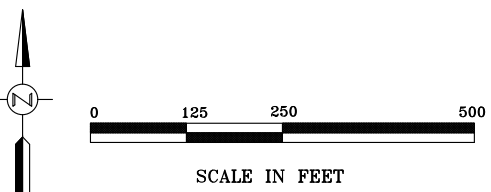
The following were surveyed by Udell Engineering and Land Surveying and have sub-centimeter accuracy: Wetlands A-E, H-Y, Sample Points 1-14, 17-26, 28-35, 37-39, 42, 43, 45, 47-56, 58-62, 65-67, 74-81, and 86-90.

The following were surveyed using a Trimble Geo7h and have submeter accuracy: Wetlands F, G, Z-GG and Sample Points 57, 68-73, 91-125, all ephemeral and intermittent streams, and all culverts.

The following were placed on the wetland delineation map by hand and are estimated to be submeter accurate: Sample Points 15, 16, 27, 36, 40, 41, 44, 46, 63, 64, 82-85.

The Study Area boundary was surveyed by Udell Engineering and Land Surveying and has sub-centimeter accuracy, with the exception of the southern portion of the boundary, which was hand-drawn in AutoCAD and verified in the field using a Thales Mobile Mapper CE GPS unit and has submeter accuracy.

The dirt access roads were digitized from a Google Earth aerial image in GIS and are estimated to have submeter accuracy.

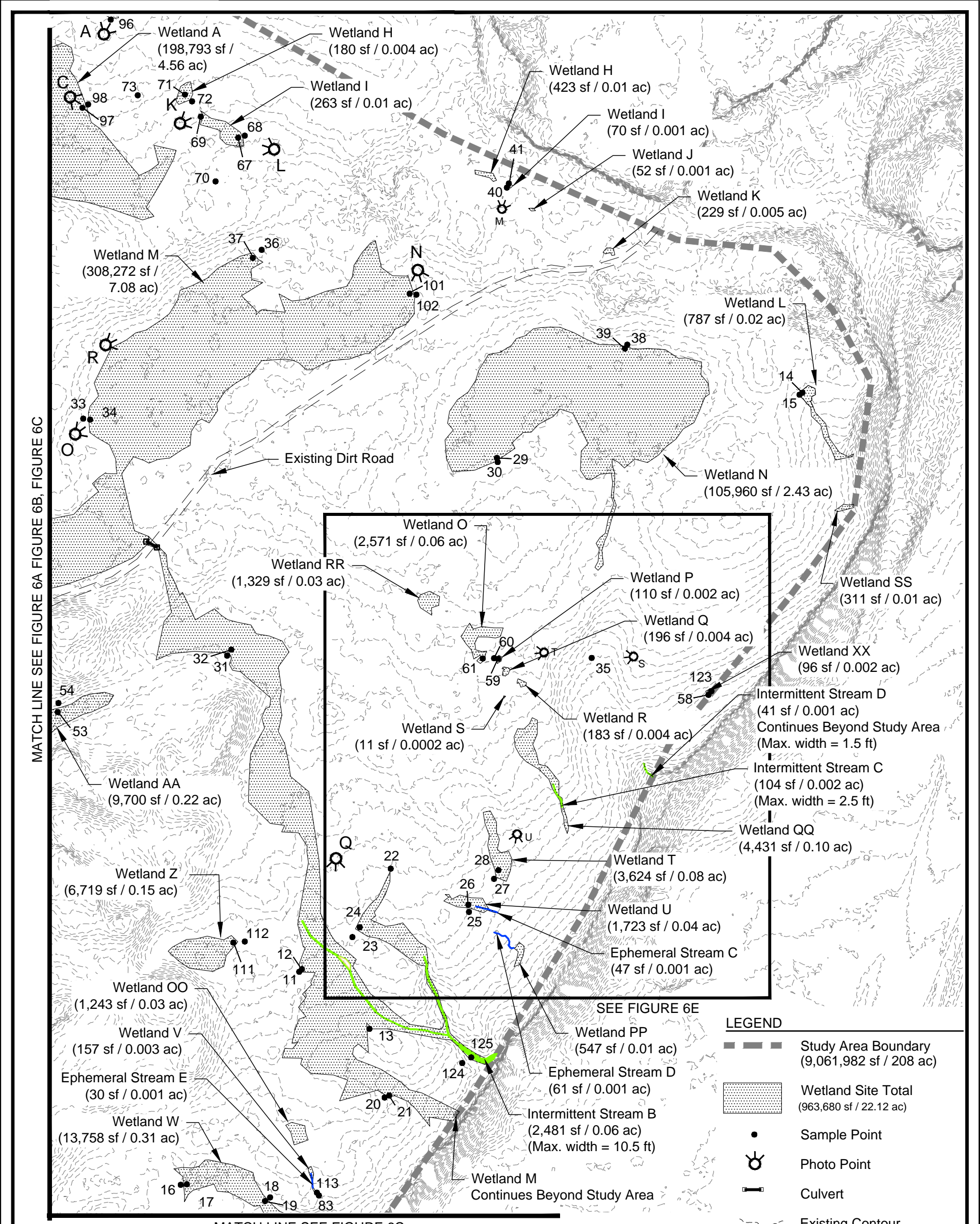


DSL WD # 2019-0623
Approval Revised 4/28/2021
Approval Expires 10/15/2025

Wetland Delineation
Watters Quarry - Saint Helens, Oregon

FIGURE
6C

10-1-2020



- LEGEND**
- Study Area Boundary (9,061,982 sf / 208 ac)
 - Wetland Site Total (963,680 sf / 22.12 ac)
 - Sample Point
 - Photo Point
 - Culvert
 - Existing Contour (LiDAR 2 Foot Interval)
 - Intermittent Stream Waters of the State/US (3,803 sf / 0.09 ac)
 - Ephemeral Stream
 - Roads

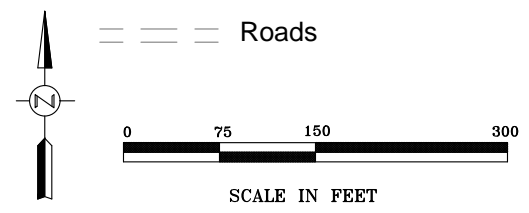
The following were surveyed by Udell Engineering and Land Surveying and have sub-centimeter accuracy: Wetlands A-E, H-Y, Sample Points 1-14, 17-26, 28-35, 37-39, 42, 43, 45, 47-56, 58-62, 65-67, 74-81, and 86-90.

The following were surveyed using a Trimble Geo7h and have submeter accuracy: Wetlands F, G, Z-GG and Sample Points 57, 68-73, 91-125, all ephemeral and intermittent streams, and all culverts.

The following were placed on the wetland delineation map by hand and are estimated to be submeter accurate: Sample Points 15, 16, 27, 36, 40, 41, 44, 46, 63, 64, 82-85.

The Study Area boundary was surveyed by Udell Engineering and Land Surveying and has sub-centimeter accuracy, with the exception of the southern portion of the boundary, which was hand-drawn in AutoCAD and verified in the field using a Thales Mobile Mapper CE GPS unit and has submeter accuracy.

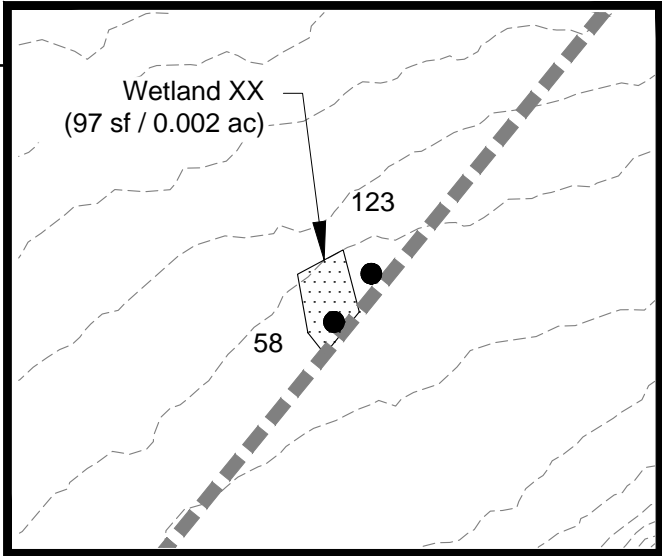
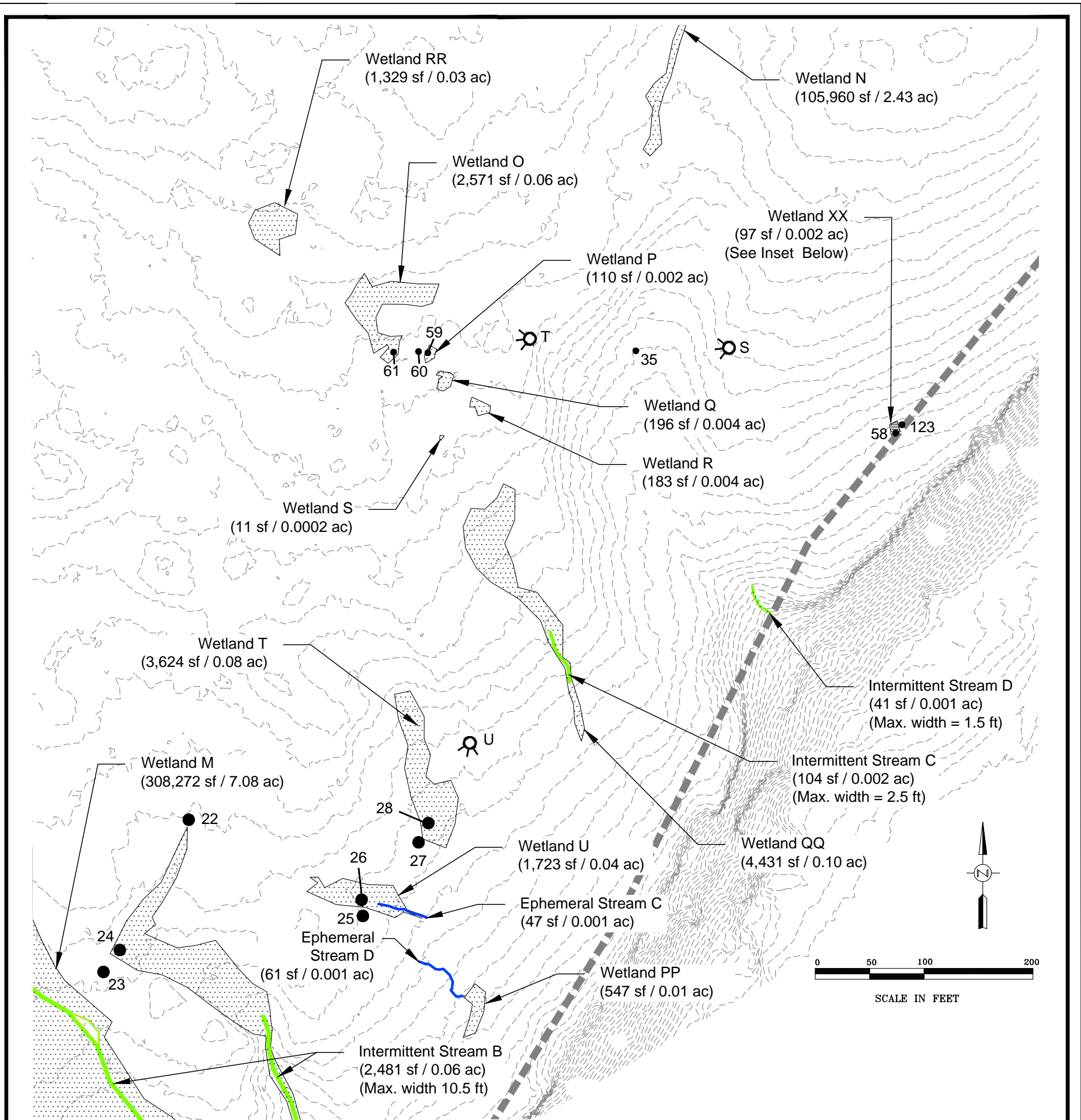
The dirt access roads were digitized from a Google Earth aerial image in GIS and are estimated to have submeter accuracy.



DSL WD # 2019-0623
Approval Revised 4/28/2021
Approval Expires 10/15/2025

Wetland Delineation
Watters Quarry - Saint Helens, Oregon
FIGURE 6D

10-1-2020



Inset of Wetland XX

The following were surveyed by Udell Engineering and Land Surveying and have sub-centimeter accuracy: Wetlands A-E, H-Y, Sample Points 1-14, 17-26, 28-35, 37-39, 42, 43, 45, 47-56, 58-62, 65-67, 74-81, and 86-90.

The following were surveyed using a Trimble Geo7h and have submeter accuracy: Wetlands F, G, Z-GG and Sample Points 57, 68-73, 91-125, all ephemeral and intermittent streams, and all culverts.

The following were placed on the wetland delineation map by hand and are estimated to be submeter accurate: Sample Points 15, 16, 27, 36, 40, 41, 44, 46, 63, 64, 82-85.

The Study Area boundary was surveyed by Udell Engineering and Land Surveying and has sub-centimeter accuracy, with the exception of the southern portion of the boundary, which was hand-drawn in AutoCAD and verified in the field using a Thales Mobile Mapper CE GPS unit and has submeter accuracy.

The dirt access roads were digitized from a Google Earth aerial image in GIS and are estimated to have submeter accuracy.

LEGEND

- Study Area Boundary (9,061,982 sf / 208 ac)
- Wetland Site Total (963,680 sf / 22.12 ac)
- Sample Point
- Photo Point
- Culvert
- Existing Contour (LiDAR 2 Foot Interval)
- Intermittent Stream Waters of the State/US (3,803 sf / 0.09 ac)
- Ephemeral Stream
- Roads



DSL WD # 2019-0623
Approval Revised 4/28/2021
Approval Expires 10/15/2025

Wetland Delineation
Watters Quarry - Saint Helens, Oregon

FIGURE
6E

9-23-2020

REVISED

Table 4. Summary of Wetland/ Other Waters within the Watters Quarry Study Area

Feature	Figure	Sample Points	Area (square feet /acre)	Cowardin Class	HGM Class	Post Submittal Revisions
Wetland A	6A	95, 96	1,545 / 0.04	PSSF	Slope	Area decreased
Wetland B	6A	1, 2, 3, 4, 9, 10, 97, 98, 99, 100	200,288 / 4.60	PFOE	Slope	Area increased
Wetland C	6B	5, 6, 7, 8, 81, 82	57,775 / 1.33	PFOE	Slope	None
Wetland D	6A	76, 77, 79, 80	39,025 / 0.89	PFOE	Slope	None
Wetland E	6A	74, 75,	9,057 / 0.21	PFOE	Slope	None
Wetland F	6A	71, 72	1,018 / 0.02	PEME	Depressional	None
Wetland G	6A	67, 68, 69	2,554 / 0.06	PEME	Depressional	None
Wetland H	6D		423 / 0.01	PEMC	Depressional	None
Wetland I	6D	40, 41	70 / 0.002	PEMC	Depressional	None
Wetland J	6D		52 / 0.001	PEMC	Depressional	None
Wetland K	6D		229 / 0.005	PEMC	Depressional	None
Wetland L	6D	14, 15	2,168 / 0.05	PEMC	Depressional	Area increased
Wetland M	6A, 6D	11, 12, 13, 20, 21, 31, 32, 33, 34, 36, 37, 101, 102	308,272 / 7.08	PFOE / PEMC	Depressional Outflow	Area increased
Wetland N	6D	29, 39, 38, 39	105,960 / 2.43	PFOE	Depressional Outflow	None
Wetland O	6E	60, 61	2,571 / 0.06	PEMC	Depressional	None
Wetland P	6E	59, 60	110 / 0.002	PEMC	Depressional	None
Wetland Q	6E		196 / 0.004	PEMC	Depressional	None
Wetland R	6E		183 / 0.004	PEMC	Depressional	None
Wetland S	6E		11 / 0.0002	PEMC	Depressional	None
Wetland T	6E	27, 28	3,624 / 0.08	PEMC	Depressional	None
Wetland U	6E	25, 26	1,723 / 0.04	PEMC	Depressional	None
Wetland V	6C	13, 83	255 / 0.01	PEMC	Depressional Outflow	None
Wetland W	6C	16, 17, 18, 19	13,741 / 0.31	PEMC	Depressional Outflow	None
Wetland Y	6C	118,425	118,425 / 2.72	PFOE / PEMC	Depressional Outflow	None
Wetland Z	6D	111, 112	6,719 / 0.15	PFOE	Depressional	None

REVISED

Wetland AA	6B	53, 54, 91, 92	9,700 / 0.22	PFOE	Depressional	None
Wetland BB	6B	51, 52	1,679 / 0.04	PFOE	Depressional	None
Wetland CC	6B	55, 56	10,981 / 0.25	PFOE	Depressional	None
Wetland DD	6B	49, 50	4,603 / 0.10	PFOE	Depressional	None
Wetland EE	6B	46, 47, 48	16,362 / 0.37	PFOE	Depressional	None
Wetland FF	6B	44, 45	12,081 / 0.28	PFOE	Depressional	None
Wetland GG	6B	63, 64	4,329 / 0.10	PFOE	Depressional	None
Wetland HH	6B	66, 117, 118	3,160 / 0.07	PFOE	Depressional	Added
Wetland JJ	6B	115, 116	4,608 / 0.11	PFOE	Depressional	Added
Wetland KK	6B	121, 122	696 / 0.02	PFOE	Depressional	Added
Wetland LL	6B	119, 120	3,122 / 0.07	PFOE	Depressional	Added
Wetland MM	6C		1,416 / 0.03	PEMC	Depressional Outflow	Added
Wetland NN	6C		179 / 0.004	PEMC	Depressional Outflow	Added
Wetland OO	6C		1,243 / 0.03	PEMC	Depressional Outflow	Added
Wetland PP	6D		547 / 0.01	PEMC	Depressional Outflow	Added
Wetland QQ	6E		4,431 / 0.10	PEMC	Depressional Outflow	Added
Wetland RR	6E		1,329 / 0.03	PEMC	Depressional Outflow	Added
Wetland SS	6E		311 / 0.01	PEMC	Depressional Outflow	Added
Wetland TT	6B		25 / 0.001	PEMC	Depressional Outflow	Added
Wetland UU	6C		71 / 0.002	PEMC	Depressional Outflow	Added
Wetland VV	6C		115 / 0.003	PEMC	Depressional Outflow	Added
Wetland WW	6C	84, 85	816 / 0.02	PEMC	Depressional Outflow	Added/ SP 85 replaced
Wetland XX	6E	58, 123	96 / 0.002	PEMC	Depressional Outflow	Added/ SP 58 replaced
Wetland YY	6B	93, 94	996 / 0.02	PEMC	Depressional Outflow	Added
Wetland ZZ	6B		2,380 / 0.05	PFOE	Depressional	Added
Wetland AAA	6C	107, 108	621 / 0.014	R4EM5	Riverine Flow Through	Added

REVISED

Wetland BBB	6C		88 / 0.002	R4EM5	Riverine Flow Through	Added
Wetland CCC	6C		206 / 0.005	R4EM5	Riverine Flow Through	Added
Wetland DDD	6C		36 / 0.001	PFOE	Depressional Outflow	Added
Wetland EEE			234 / 0.005	PFOE	Depressional Outflow	Added
Wetland FFF	6C		148 / 0.003	PFOE	Depressional Outflow	Added
Wetland 1-A	6A	SP-03, SP-04	1,077 / 0.025	PEM1E	Slope	Added
Total Wetlands			963,680 / 22.12			
Ephemeral Stream A	6C		117 / 0.002	N/A	Riverine Flow-Through	Added
Ephemeral Stream B	6A		215 / 0.005	N/A	Riverine Flow-Through	Added
Ephemeral Stream C	6D		47 / 0.001	N/A	Riverine Flow-Through	Added
Ephemeral Stream D	6D		61 / 0.001	N/A	Riverine Flow-Through	Added
Ephemeral Stream E	6D		30 / 0.001	N/A	Riverine Flow-Through	Added
Ephemeral Stream F	6C		11 / 0.0002	N/A	Riverine Flow-Through	Added
Ephemeral Stream G	6C		32 / 0.001	N/A	Riverine Flow-Through	Added
Ephemeral Stream 1-A	6A		141 / 0.003	N/A	Riverine Flow-Through	Added
Total Ephemeral Streams			654 / 0.01			
Intermittent Stream A	6C		1,177 / 0.03	R4RB1	Riverine Flow-Through	Reduced
Intermittent Stream B	6C, 6D		2,481 / 0.06	R4RB1	Riverine Flow-	Added

REVISED

					Through	
Intermittent Stream C	6D		104 / 0.002	R4RB1	Riverine Flow-Through	Added
Intermittent Stream D	6D		41 / 0.001	R4RB1	Riverine Flow-Through	Added
Total Intermittent Streams			3,803 / 0.09			
Perennial Stream 1-A	6A		407 / 0.009	R2UBH	Riverine Flow-Through	Added
Total Perennial Stream			407 / 0.01			



Oregon

Kate Brown, Governor

Department of State Lands

775 Summer Street NE, Suite 100

Salem, OR 97301-1279

(503) 986-5200

FAX (503) 378-4844

www.oregon.gov/dsl

State Land Board

October 15, 2020

**See Revised Letter
Dated 4/28/2021**

Weyerhaeuser
Attn: Mary Castle
220 Occidental Ave. S.
Seattle, WA 98014

Kate Brown
Governor

Bev Clarno
Secretary of State

Re: WD # 2019-0623 **Approved with Revisions**
Wetland Delineation Report for Watters Quarry
Columbia County; Multiple Tax Maps and Tax Lots
(See Attached Maps & Table)

Tobias Read
State Treasurer

Dear Ms. Castle:

The Department of State Lands has reviewed the wetland delineation report prepared by Pacific Habitat Services for the site referenced above. Please note that the study area includes only a portion of the area described above (see the attached maps and table). Based upon the information presented in the report, site visits on March 4 and 5, 2020, and additional information submitted upon request, we concur with the wetland and waterway boundaries as mapped in revised Figure 6 and 6A through 6E of the report. Please replace all copies of the preliminary wetland maps with these final Department-approved maps.

Within the study area, 56 wetlands (Wetland A through W,Y,Z, AA through HH, JJ through ZZ, AAA through FFF) and 11 waterways (Intermittent Stream A through D, and Ephemeral Stream A through G) were identified. All the wetlands totaling approximately 22.1 acres (except Wetland K) and 4 intermittent streams are subject to the permit requirements of the state Removal-Fill Law. Under current regulations, a state permit is required for cumulative fill or annual excavation of 50 cubic yards or more in wetlands or below the ordinary high-water line (OHWL) of the waterway (or the 2-year recurrence interval flood elevation if OHWL cannot be determined). The ephemeral streams and Wetland K are exempt per OAR 141-085-0515(3) & (6) respectively; therefore, these features are not subject to current state Removal-Fill requirements.

This concurrence is for purposes of the state Removal-Fill Law only. We recommend that you attach a copy of this concurrence letter to any subsequent state permit application to speed application review. Federal or local permit requirements may apply as well. The U.S. Army Corps of Engineers will determine jurisdiction under the Clean Water Act, which may require submittal of a complete Wetland Delineation Report.

**See Revised Letter
Dated 4/28/2021**

Please be advised that state law establishes a preference for avoidance of wetland impacts. Because measures to avoid and minimize wetland impacts may include reconfiguring parcel layout and size or development design, we recommend that you work with Department staff on appropriate site design before completing the city or county land use approval process.

This concurrence is based on information provided to the agency. The jurisdictional determination is valid for five years from the date of this letter unless new information necessitates a revision. Circumstances under which the Department may change a determination are found in OAR 141-090-0045 (available on our web site or upon request). In addition, laws enacted by the legislature and/or rules adopted by the Department may result in a change in jurisdiction; individuals and applicants are subject to the regulations that are in effect at the time of the removal-fill activity or complete permit application. The applicant, landowner, or agent may submit a request for reconsideration of this determination in writing within six months of the date of this letter.

Thank you for having the site evaluated. If you have any questions, please contact the Jurisdiction Coordinator for Columbia County, Daniel Evans, PWS, at (503) 986-5271.

Sincerely,



Peter Ryan, SPWS
Aquatic Resource Specialist

Enclosures

ec: Joe Thompson, Pacific Habitat Services
Columbia County Planning Department
Caila Heintz, Corps of Engineers
Mike De Blasi, DSL
Joy Vaughan, ODFW (for large scale projects-linear, mining, etc.)

WETLAND DELINEATION / DETERMINATION REPORT COVER FORM


Fully completed and signed report cover forms and applicable fees are required before report review timelines are initiated by the Department of State Lands. Make the checks payable to the Oregon Department of State Lands. To pay fees by credit card, go online at: <https://apps.oregon.gov/DSL/EPS/program?key=4>.

Attach this completed and signed form to the front of an unbound report or include a hard copy with a digital version (single PDF file of the report cover form and report, minimum 300 dpi resolution) and submit to, **Oregon Department of State Lands, 775 Summer Street NE, Suite 100, Salem, OR 97301-1279**. A single PDF of the completed cover form and report may be e-mailed to **Wetland_Delineation@dsl.state.or.us**. For submittal of PDF files larger than 10 MB, e-mail DSL instructions on how to access the file from your ftp or other file sharing website.

Contact and Authorization Information

<input type="checkbox"/> Applicant <input checked="" type="checkbox"/> Owner Name, Firm and Address: Weyerhaeuser 220 Occidental Ave South Seattle, WA 98104	Business phone # 503-479-2309 Mobile phone # (optional) E-mail: mary.castle@weyerhaeuser.com
--	--


<input checked="" type="checkbox"/> Authorized Legal Agent, Name and Address: Mary Castle (for Weyerhaeuser)	Business phone # same as above Mobile phone # E-mail:
--	---

I either own the property described below or I have legal authority to allow access to the property. I authorize the Department to access the property for the purpose of confirming the information in the report, after prior notification to the primary contact.
 Typed/Printed Name: Mary Castle Signature: 
 Date: 11/19/2019 Special instructions regarding site access: **Contact Jeff Steyaert 541-918-5142**

Project and Site Information

Project Name: Watters Quarry	Latitude: 45.87004 Longitude: -122.82403, decimal degree - centroid of site or start & end points of linear project
	Tax Map # See next page for tax map information
	Tax Lot(s) -----
Proposed Use: Quarry	Tax Map # Tax Lot(s)
Project Street Address (or other descriptive location): Liberty Hill Road	Township Range Section QQ Use separate sheet for additional tax and location information
City: St Helens County: Clatsop	Waterway: N/A River Mile: N/A NWI Quad(s): St Helens, Deer Island

Wetland Delineation Information

Wetland Consultant Name, Firm and Address: Pacific Habitat Services Attn: Joe Thompson, PWS 9450 SW Commerce Circle, Suite 180 Wilsonville, OR 97070	Phone # 503-570-0800 Mobile phone # E-mail: jt@pacifichabitat.com
The information and conclusions on this form and in the attached report are true and correct to the best of my knowledge.	
Consultant Signature: 	Date: 11/18/2019

Primary Contact for report review and site access is Consultant Applicant/Owner Authorized Agent

Wetland/Waters Present? Yes No Study Area size: **208 acre** Total Wetland Acreage: **22.1**

Check Applicable Boxes Below

<input type="checkbox"/> R-F permit application submitted	<input checked="" type="checkbox"/> Fee payment submitted \$454
<input type="checkbox"/> Mitigation bank site	<input type="checkbox"/> Fee (\$100) for resubmittal of rejected report
<input type="checkbox"/> Industrial Land Certification Program Site	<input type="checkbox"/> Request for Reissuance. See eligibility criteria (no fee)
<input type="checkbox"/> Wetland restoration/enhancement project (not mitigation)	DSL # _____ Expiration Date _____
<input type="checkbox"/> Previous delineation/application on parcel? If Known, previous DSL # _____	<input type="checkbox"/> LWI shows wetlands or waters on parcel? Wetland ID Code _____

For Office Use Only

DSL Reviewer: _____ Fee Paid Date: ____ / ____ / ____	DSL WD # 2019-0623
Date Delineation Received: ____ / ____ / ____ Scanned: <input type="checkbox"/> Final Scan: <input type="checkbox"/>	DSL App. # _____

Tax Lot Table for WD2019-0623

Township	Range	Section	Tax Lots
5 North	1 West	33	Portions of 300, 400
		32	1600
		32DD	100
4 North	1 West	5AA	11200
		4B0	400, portion of 900

See Revised Table 4
Dated 4/28/2021

Table 4. Summary of Wetland/ Other Waters within the Watters Quarry Study Area

Feature	Figure	Sample Points	Area (square feet / acre)	Cowardin Class	HGM Class	Post Submittal Revisions
Wetland A	6A	95, 96	1,738 / 0.04	PSSF	Slope	None
Wetland B	6A	1, 2, 3, 4, 9, 10, 97, 98, 99, 100	200,288 / 4.6	PFOE	Slope	Area increased
Wetland C	6B	5, 6, 7, 8, 81, 82	57,775 / 1.33	PFOE	Slope	None
Wetland D	6A	76, 77, 79, 80	39,025 / 0.89	PFOE	Slope	None
Wetland E	6A	74, 75,	9,057 / 0.21	PFOE	Slope	None
Wetland F	6A	71, 72	1,018 / 0.02	PEME	Depressional	None
Wetland G	6A	67, 68, 69	2,554 / 0.06	PEME	Depressional	None
Wetland H	6D		423 / 0.01	PEMC	Depressional	None
Wetland I	6D	40, 41	70 / 0.002	PEMC	Depressional	None
Wetland J	6D		52 / 0.001	PEMC	Depressional	None
Wetland K	6D		229 / 0.005	PEMC	Depressional	None
Wetland L	6D	14, 15	2,168 / 0.05	PEMC	Depressional	Area increased
Wetland M	6A, 6D	11, 12, 13, 20, 21, 31, 32, 33, 34, 36, 37, 101, 102	308,272 / 7.08	PFOE / PEMC	Depressional Outflow	Area increased
Wetland N	6D	29, 39, 38, 39	105,960 / 2.43	PFOE	Depressional Outflow	None
Wetland O	6E	60, 61	2,571 / 0.06	PEMC	Depressional	None
Wetland P	6E	59, 60	110 / 0.002	PEMC	Depressional	None
Wetland Q	6E		196 / 0.004	PEMC	Depressional	None
Wetland R	6E		183 / 0.004	PEMC	Depressional	None
Wetland S	6E		11 / 0.0002	PEMC	Depressional	None
Wetland T	6E	27, 28	3,624 / 0.08	PEMC	Depressional	None
Wetland U	6E	25, 26	1,723 / 0.04	PEMC	Depressional	None
Wetland V	6C	13, 83	255 / 0.01	PEMC	Depressional Outflow	None
Wetland W	6C	16, 17, 18, 19	13,741 / 0.31	PEMC	Depressional Outflow	None

See Revised Table 4
Dated 4/28/2021

WD2019-0623

Feature	Figure	Sample Points	Area (square feet / acre)	Cowardin Class	HGM Class	Post Submittal Revisions
Wetland Y	6C	118,425	118,425 / 2.72	PFOE / PEMC	Depressional Outflow	None
Wetland Z	6D	111, 112	6,719 / 0.15	PFOE	Depressional	None
Wetland AA	6B	53, 54, 91, 92	9,700 / 0.22	PFOE	Depressional	None
Wetland BB	6B	51, 52	1,679 / 0.04	PFOE	Depressional	None
Wetland CC	6B	55, 56	10,981 / 0.25	PFOE	Depressional	None
Wetland DD	6B	49, 50	4,603 / 0.10	PFOE	Depressional	None
Wetland EE	6B	46, 47, 48	16,362 / 0.37	PFOE	Depressional	None
Wetland FF	6B	44, 45	12,081 / 0.28	PFOE	Depressional	None
Wetland GG	6B	63, 64	4,329 / 0.10	PFOE	Depressional	None
Wetland HH	6B	66, 117, 118	3,160 / 0.07	PFOE	Depressional	Added
Wetland JJ	6B	115, 116	4,608 / 0.11	PFOE	Depressional	Added
Wetland KK	6B	121, 122	696 / 0.02	PFOE	Depressional	Added
Wetland LL	6B	119, 120	3,122 / 0.07	PFOE	Depressional	Added
Wetland MM	6C		1,416 / 0.03	PEMC	Depressional Outflow	Added
Wetland NN	6C		179 / 0.004	PEMC	Depressional Outflow	Added
Wetland OO	6C		1243 / 0.03	PEMC	Depressional Outflow	Added
Wetland PP	6D		547 / 0.01	PEMC	Depressional Outflow	Added
Wetland QQ	6E		4,431 / 0.1	PEMC	Depressional Outflow	Added
Wetland RR	6E		1,329 / 0.03	PEMC	Depressional Outflow	Added
Wetland SS	6E		311 / 0.01	PEMC	Depressional Outflow	Added
Wetland TT	6B		25 / 0.001	PEMC	Depressional Outflow	Added
Wetland UU	6C		71 / 0.002	PEMC	Depressional Outflow	Added
Wetland VV	6C		115 / 0.003	PEMC	Depressional Outflow	Added
Wetland WW	6C	84, 85	816 / 0.02	PEMC	Depressional Outflow	Added/SP 85 replaced

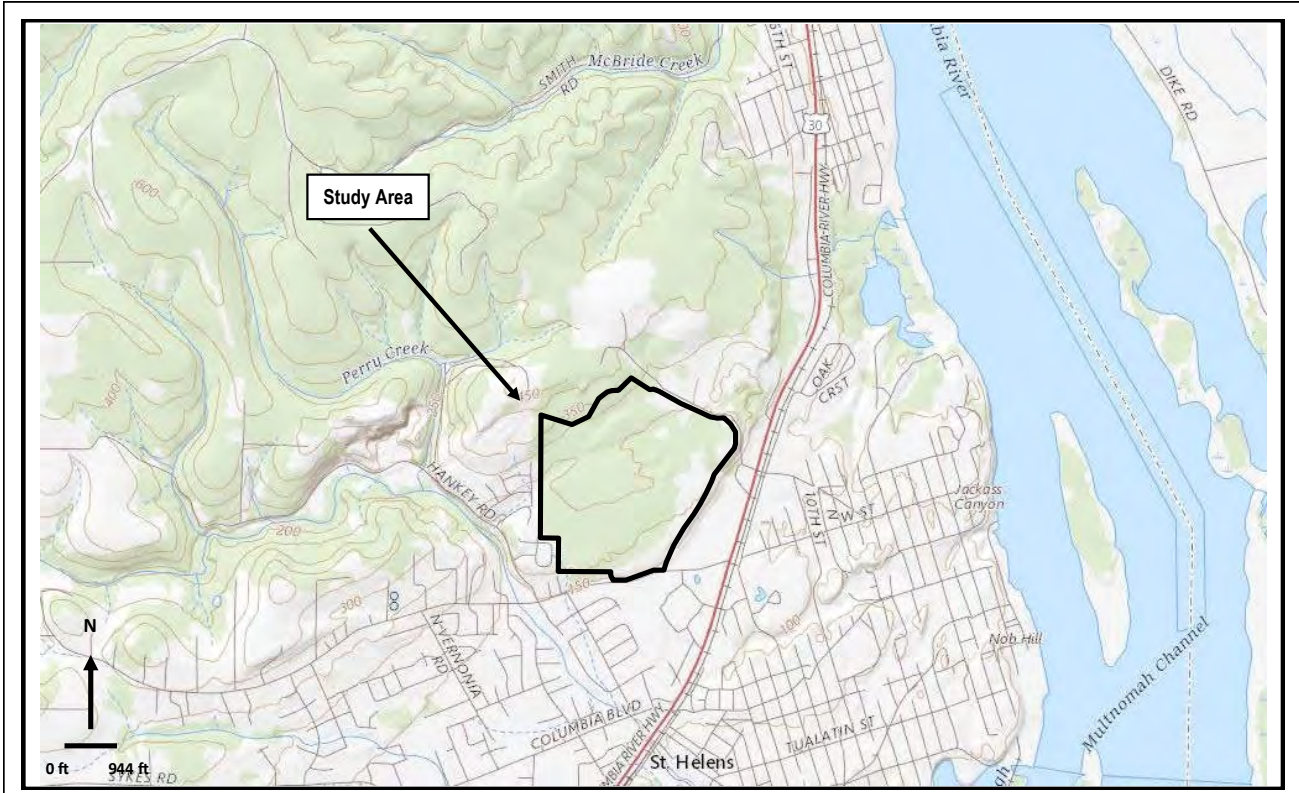
See Revised Table 4
Dated 4/28/2021

WD2019-0623

Feature	Figure	Sample Points	Area (square feet / acre)	Cowardin Class	HGM Class	Post Submittal Revisions
Wetland XX	6E	58, 123	96 / 0.002	PEMC	Depressional Outflow	Added/SP 58 replaced
Wetland YY	6B	93, 94	996 / 0.02	PEMC	Depressional Outflow	Added
Wetland ZZ	6B		2,380 / 0.05-	PFOE	Depressional	Added
Wetland AAA	6C	107, 108	621 / 0.014	R4EM5	Riverine Flow Through	Added
Wetland BBB	6C		88 / 0.002	R4EM5	Riverine Flow Through	Added
Wetland CCC	6C		206 / 0.005	R4EM5	Riverine Flow Through	Added
Wetland DDD	6C		36 / 0.001	PFOE	Depressional Outflow	Added
Wetland EEE			234 / 0.005	PFOE	Depressional Outflow	Added
Wetland FFF	6C		148 / 0.003	PFOE	Depressional Outflow	Added
Total Wetlands			962,796 / 22.1			
Ephemeral Stream A	6C		117 / 0.002	N/A	Riverine Flow-Through	Added
Ephemeral Stream B	6A		215 / 0.005	N/A	Riverine Flow-Through	Added
Ephemeral Stream C	6D		47 / 0.001	N/A	Riverine Flow-Through	Added
Ephemeral Stream D	6D		61 / 0.001	N/A	Riverine Flow-Through	Added
Ephemeral Stream E	6D		30 / 0.001	N/A	Riverine Flow-Through	Added
Ephemeral Stream F	6C		11 / 0.0002	N/A	Riverine Flow-Through	Added

See Revised Table 4
Dated 4/28/2021

Feature	Figure	Sample Points	Area (square feet / acre)	Cowardin Class	HGM Class	Post Submittal Revisions
Ephemeral Stream G	6C		32 / 0.001	N/A	Riverine Flow-Through	Added
Total Ephemeral Streams			3,823 / 0.09			
Intermittent Stream A			1,177 / 0.03	R4RB1	Riverine Flow-Through	Reduced
Intermittent Stream B			2,481 / 0.06	R4RB1	Riverine Flow-Through	Added
Intermittent Stream C			104 / 0.002	R4RB1	Riverine Flow-Through	Added
Intermittent Stream D			61 / 0.001	R4RB1	Riverine Flow-Through	Added
Total Intermittent Streams			513 / 0.01			



#6300
5/20/2019

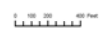


Pacific Habitat Services, Inc.
9450 SW Commerce Circle, Suite 180
Wilsonville, OR 97070

General Location and Topography
Watters Quarry - Saint Helens, Oregon
United States Geological Survey (USGS), St. Helens, Oregon-Washington, 7.5 Quadrangle, 2017
United States Geological Survey (USGS), Deer Island, Oregon-Washington, 7.5 Quadrangle, 2017
(viewer/nationalmap.gov/basic)

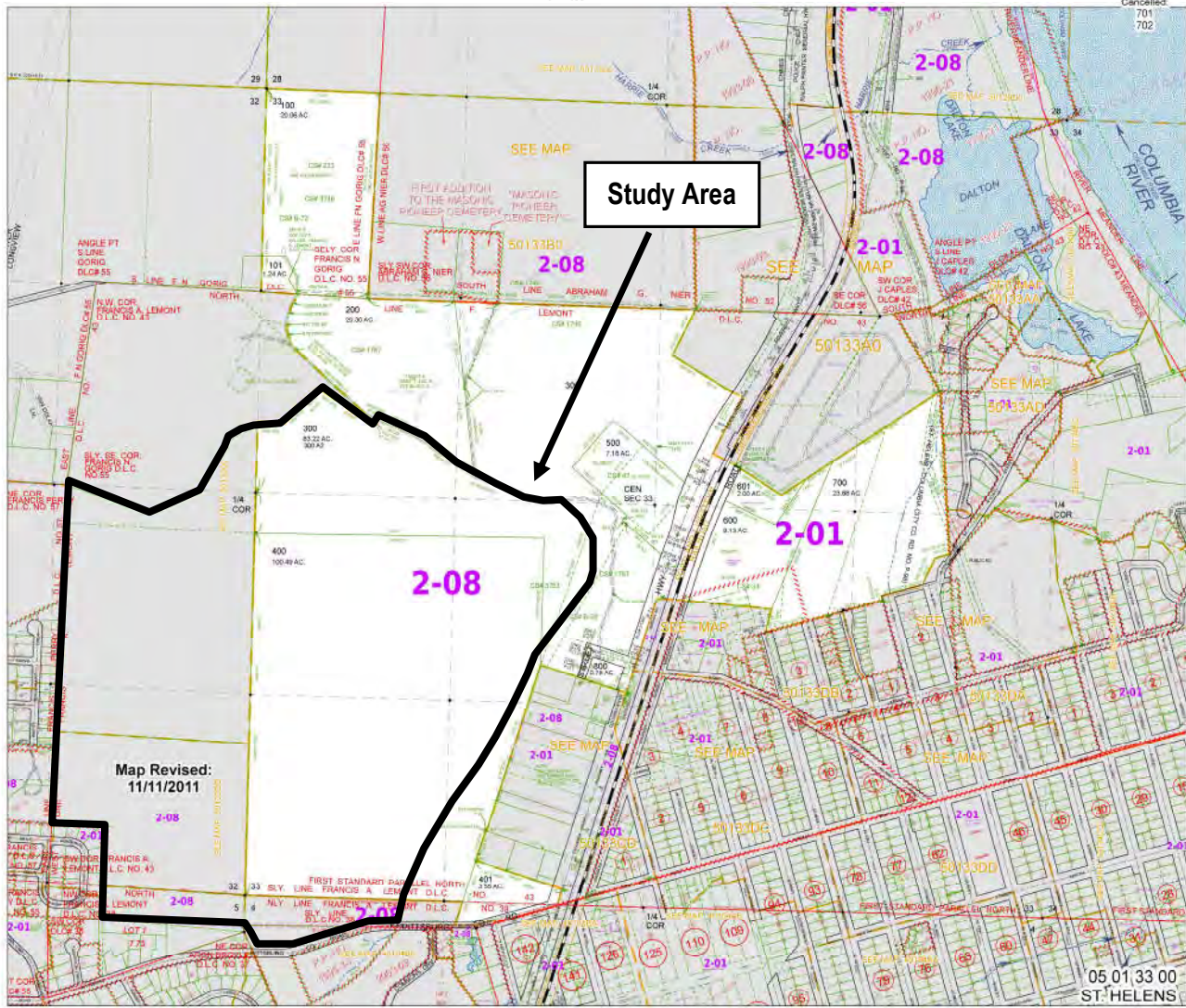
FIGURE
1

THIS MAP WAS PREPARED FOR ASSESSMENT PURPOSE ONLY



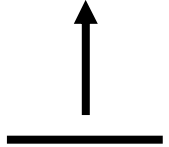
SECTION 33 T.5N. R.1W. W.M.
COLUMBIA COUNTY
1" = 400'

05 01 33 00
ST. HELENS
Cancelled:
701
702



Study Area

N



0 ft 944 ft

Map Revised:
11/11/2011

#6300
5/20/2019



Pacific Habitat Services, Inc.
9450 SW Commerce Circle, Suite 180
Wilsonville, OR 97070

Tax Lot Map
Watters Quarry - Saint Helens, Oregon
The Oregon Map (ormap.net), 2018

FIGURE
2A

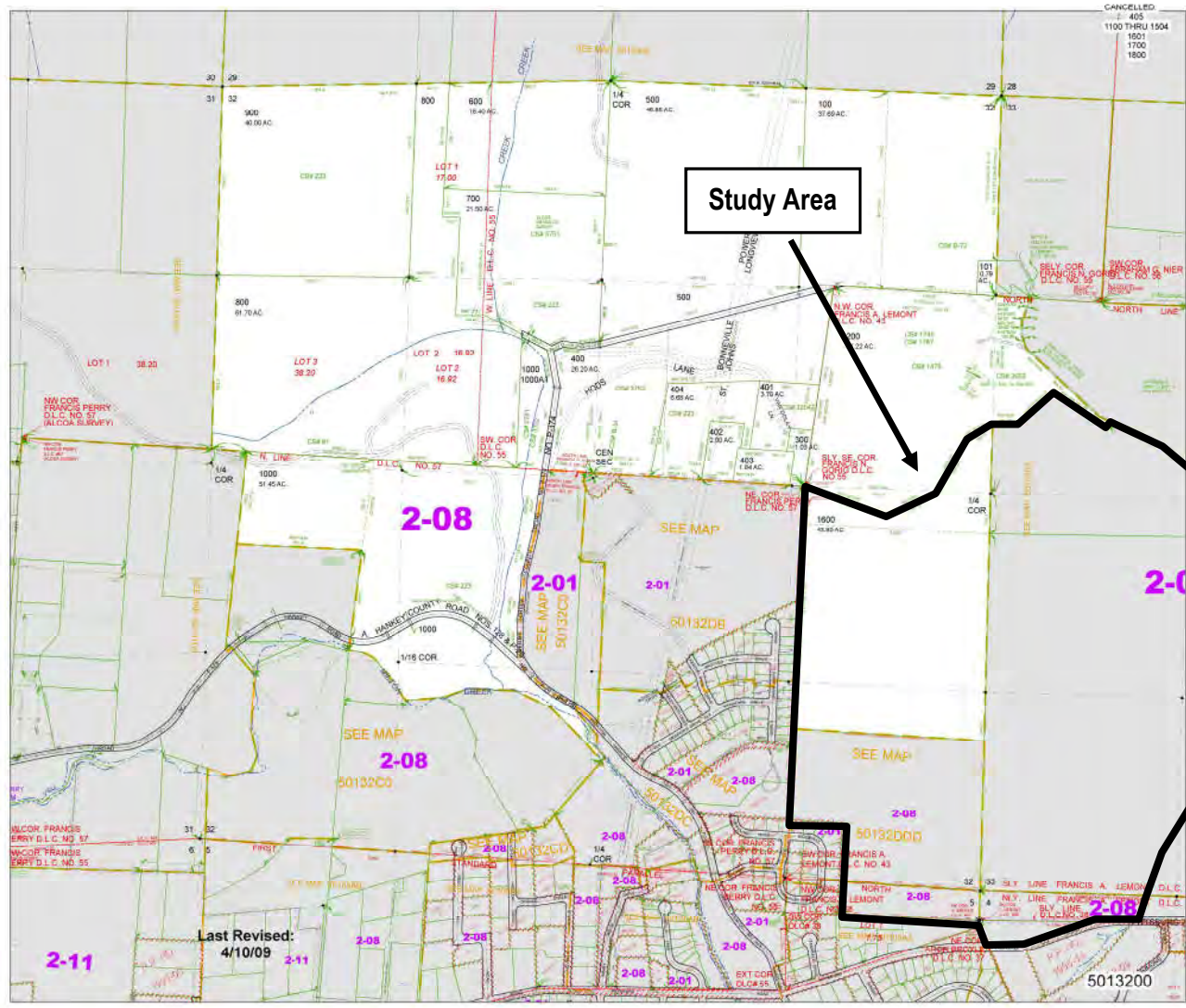
THIS MAP WAS PREPARED FOR ASSESSMENT PURPOSE ONLY

0 100 200 400 Feet

SECTION 32 T.5N. R.1W. W.M.
COLUMBIA COUNTY
1" = 400'

5013200

CANCELLED
C 405
1100 THRU 1504
1601
1700
1800



Study Area



0 ft 944 ft

Last Revised:
4/10/09

#6300
5/20/2019



Pacific Habitat Services, Inc.
9450 SW Commerce Circle, Suite 180
Wilsonville, OR 97070

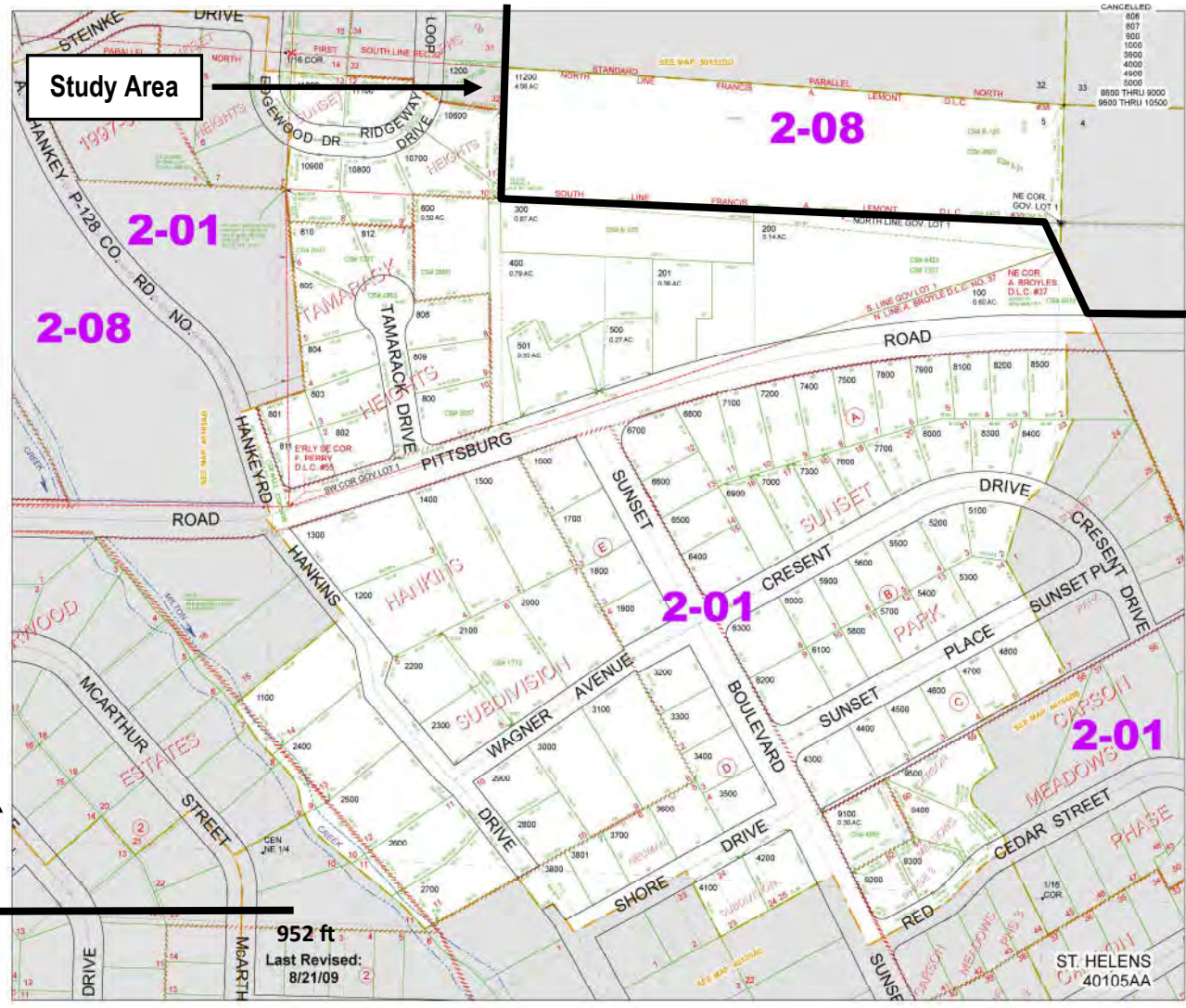
Tax Lot Map
Watters Quarry - Saint Helens, Oregon
The Oregon Map (ormap.net), 2018

FIGURE
2B

THIS MAP WAS PREPARED FOR ASSESSMENT PURPOSE ONLY

N.E.1/4 N.E.1/4 SEC.5 T.4N. R.1W. W.M.
COLUMBIA COUNTY
1" = 100'

40105AA
ST. HELENS



#6300
5/20/2019



Pacific Habitat Services, Inc.
9450 SW Commerce Circle, Suite 180
Wilsonville, OR 97070

Tax Lot Map
Watters Quarry - Saint Helens, Oregon
The Oregon Map (ormap.net), 2018

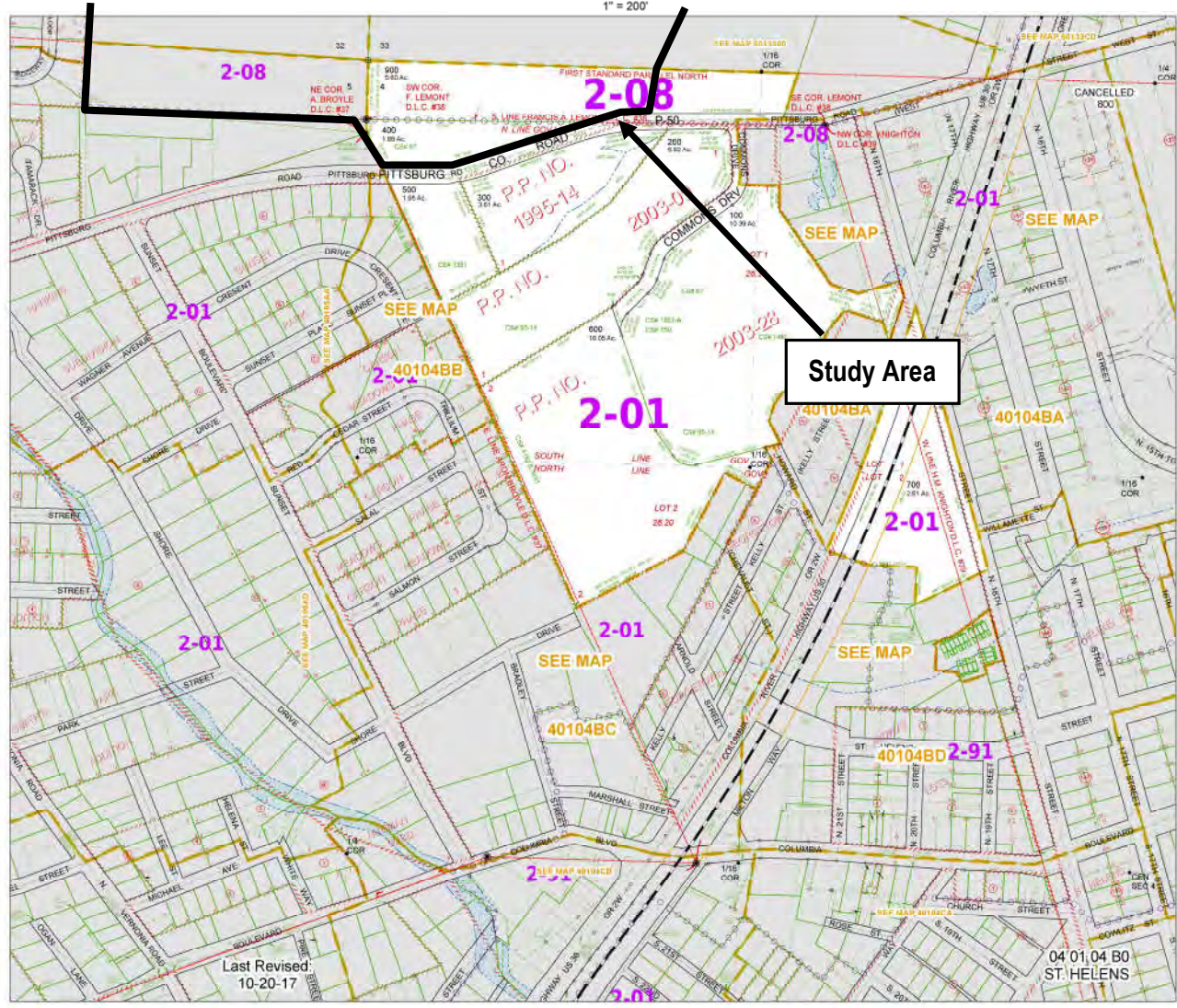
FIGURE
2D

THIS MAP WAS PREPARED FOR ASSESSMENT PURPOSE ONLY

1" = 200'

N.W.1/4 SEC.4 T.4N. R.1W. W.M.
COLUMBIA COUNTY

04 01 04 B0
ST. HELENS



Last Revised:
10-20-17

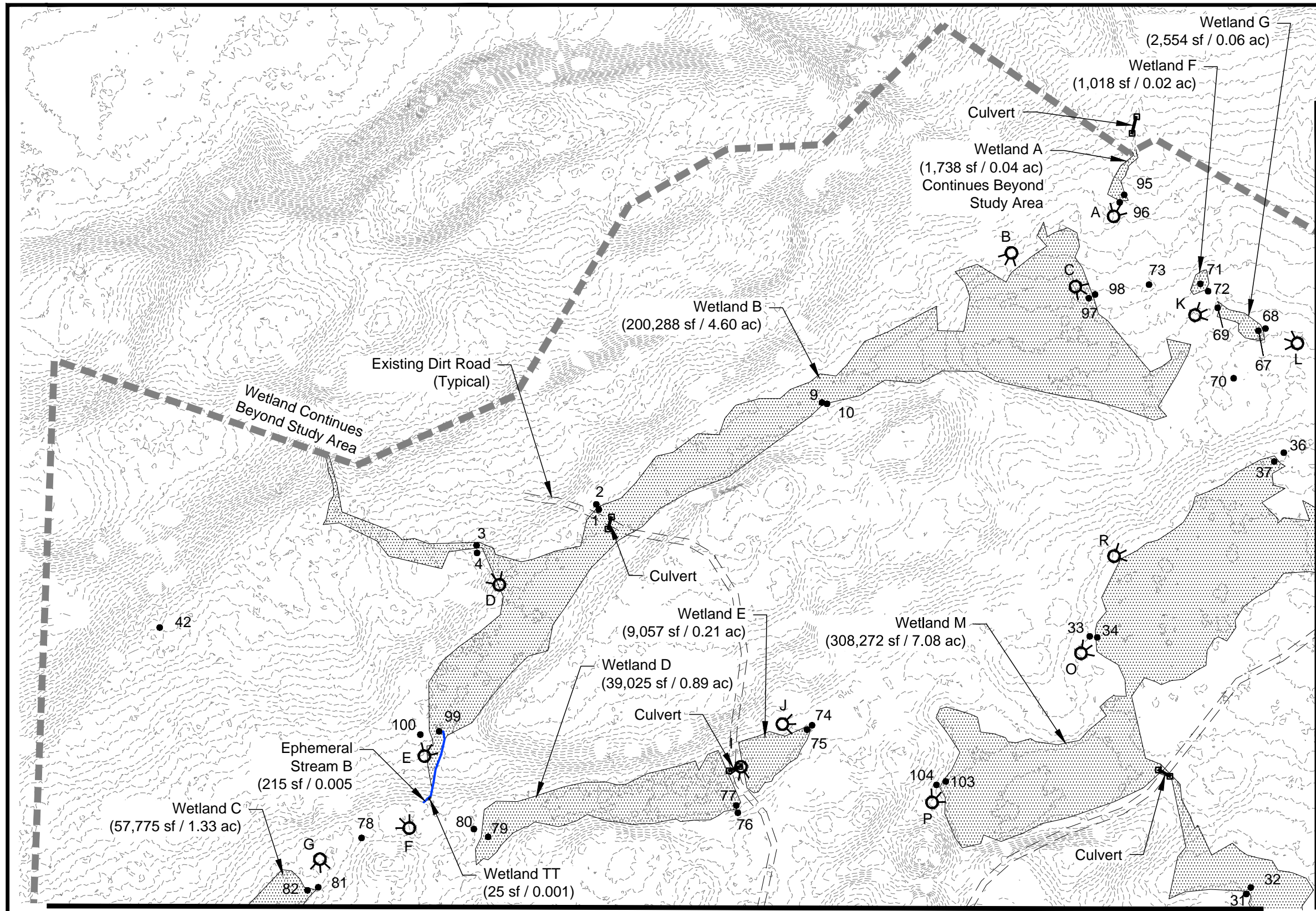
#6300
5/20/2019



Pacific Habitat Services, Inc.
9450 SW Commerce Circle, Suite 180
Wilsonville, OR 97070

Tax Lot Map
Watters Quarry - Saint Helens, Oregon
The Oregon Map (ormap.net), 2018

FIGURE
2E



LEGEND

- Study Area Boundary (9,061,982 sf / 208 ac)
- Wetland Site Total (962,796 sf / 22.1 ac)
- Sample Point
- Photo Point
- Culvert
- Existing Contour (LiDAR 2 Foot Interval)
- Intermittent Stream Waters of the State/US (3,803 sf / 0.09 ac)
- Ephemeral Stream
- Roads

MATCH LINE SEE FIGURE 6D

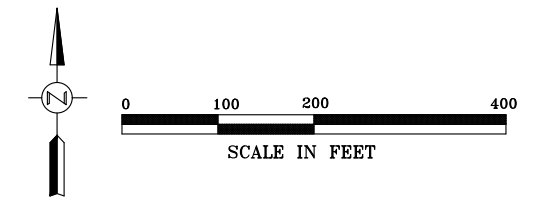
The following were surveyed by Udell Engineering and Land Surveying and have sub-centimeter accuracy: Wetlands A-E, H-Y, Sample Points 1-14, 17-26, 28-35, 37-39, 42, 43, 45, 47-56, 58-62, 65-67, 74-81, and 86-90.

The following were surveyed using a Trimble Geo7h and have submeter accuracy: Wetlands F, G, Z-GG and Sample Points 57, 68-73, 91-125, all ephemeral and intermittent streams, and all culverts.

The following were placed on the wetland delineation map by hand and are estimated to be submeter accurate: Sample Points 15, 16, 27, 36, 40, 41, 44, 46, 63, 64, 82-85.

The Study Area boundary was surveyed by Udell Engineering and Land Surveying and has sub-centimeter accuracy, with the exception of the southern portion of the boundary, which was hand-drawn in AutoCAD and verified in the field using a Thales Mobile Mapper CE GPS unit and has submeter accuracy.

The dirt access roads were digitized from a Google Earth aerial image in GIS and are estimated to have submeter accuracy.



MATCH LINE SEE FIGURE 6B



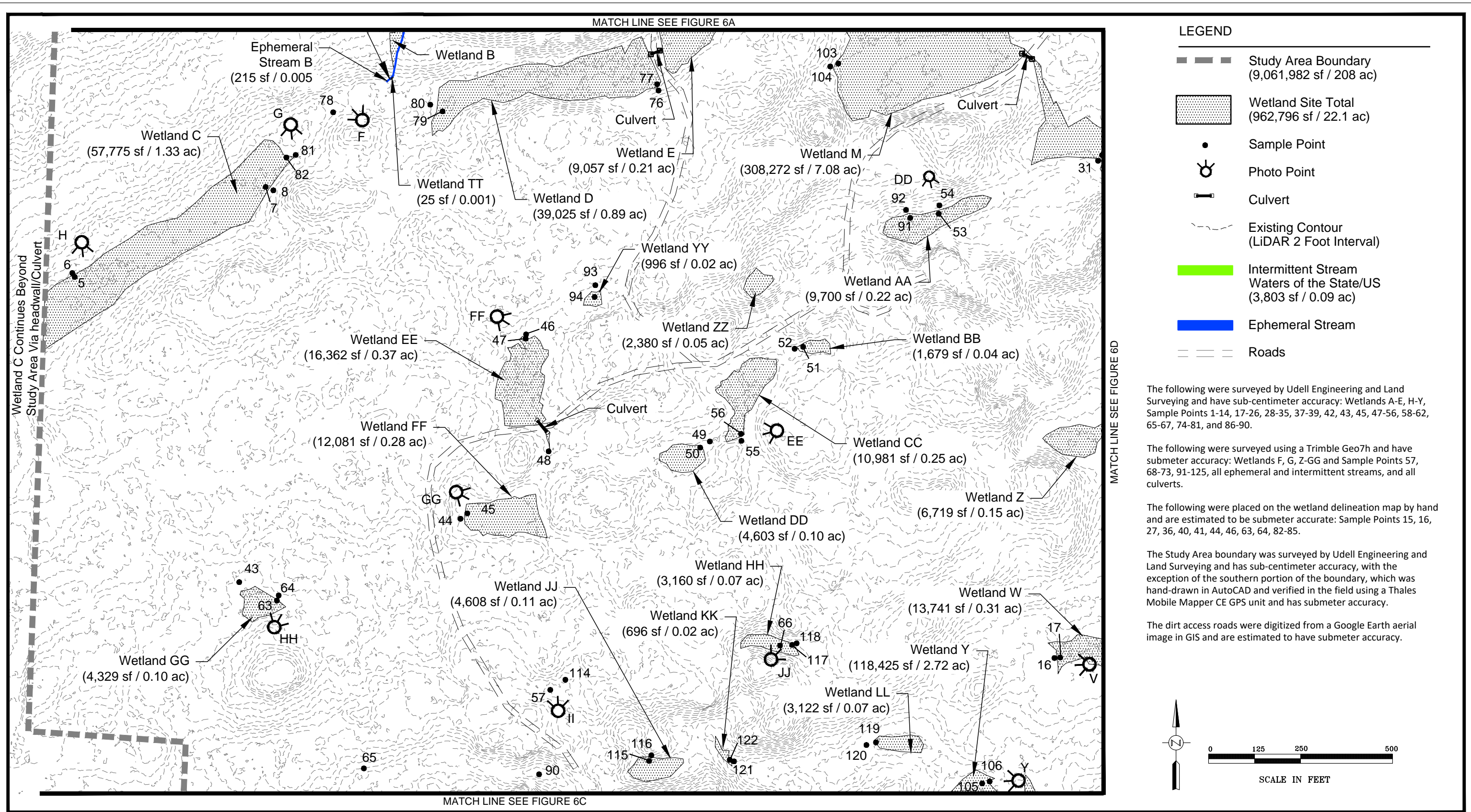
**See Revised Figure 6A
Dated 4/28/2021**

**DSL WD # 2019-0623
Approval Issued 10/15/2020
Approval Expires 10/15/2025**

Wetland Delineation
Watters Quarry - Saint Helens, Oregon

**FIGURE
6A**

10-1-2020



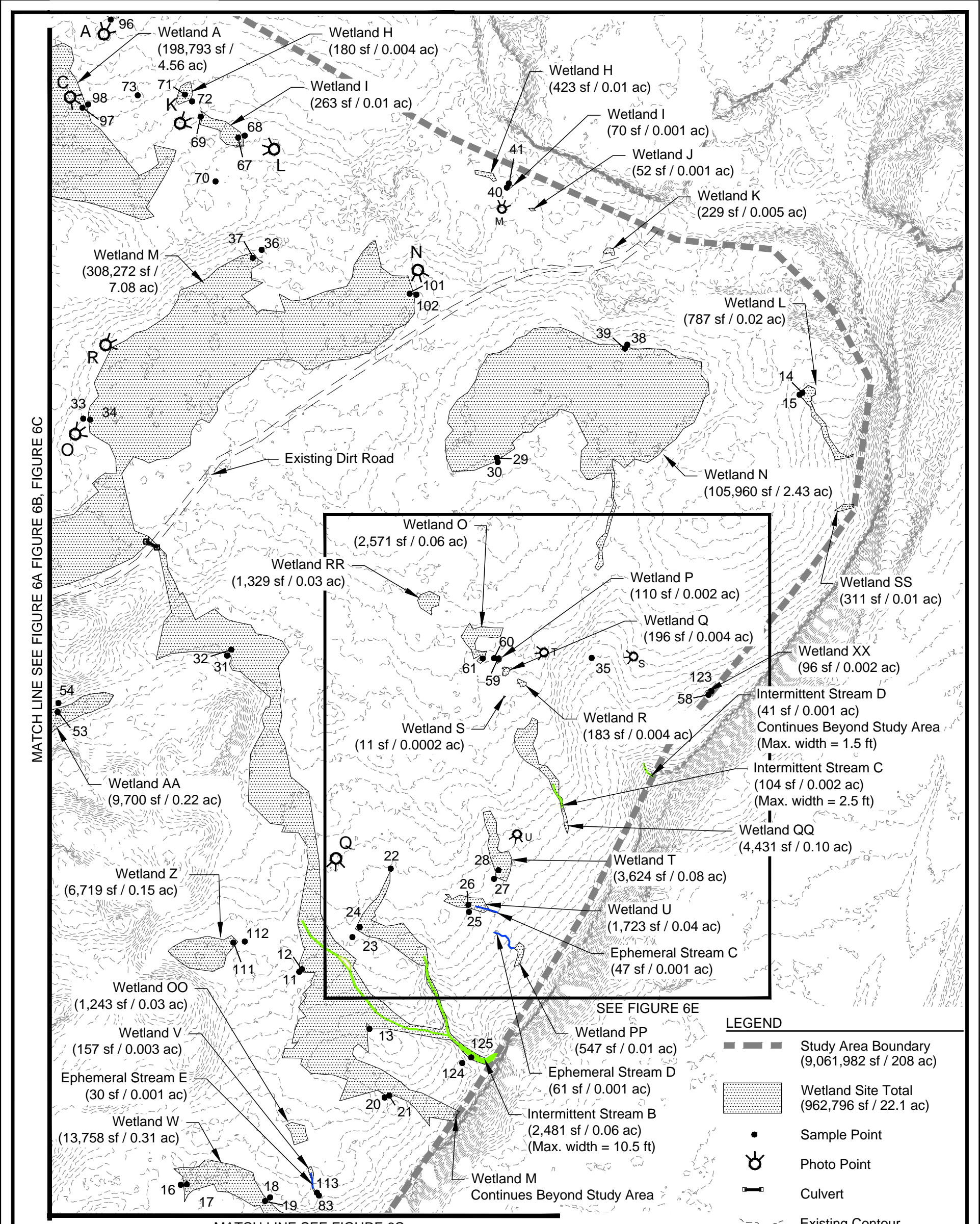
**See Revised Figure 6B
Dated 4/28/2021**

**DSL WD # 2019-0623
Approval Issued 10/15/2020
Approval Expires 10/15/2025**

Wetland Delineation
Watters Quarry - Saint Helens, Oregon

**FIGURE
6B**

10-1-2020



LEGEND

- Study Area Boundary (9,061,982 sf / 208 ac)
- Wetland Site Total (962,796 sf / 22.1 ac)
- Sample Point
- Photo Point
- Culvert
- Existing Contour (LiDAR 2 Foot Interval)
- Intermittent Stream Waters of the State/US (3,803 sf / 0.09 ac)
- Ephemeral Stream
- Roads

SCALE IN FEET

0 75 150 300

The following were surveyed by Udell Engineering and Land Surveying and have sub-centimeter accuracy: Wetlands A-E, H-Y, Sample Points 1-14, 17-26, 28-35, 37-39, 42, 43, 45, 47-56, 58-62, 65-67, 74-81, and 86-90.

The following were surveyed using a Trimble Geo7h and have submeter accuracy: Wetlands F, G, Z-GG and Sample Points 57, 68-73, 91-125, all ephemeral and intermittent streams, and all culverts.

The following were placed on the wetland delineation map by hand and are estimated to be submeter accurate: Sample Points 15, 16, 27, 36, 40, 41, 44, 46, 63, 64, 82-85.

The Study Area boundary was surveyed by Udell Engineering and Land Surveying and has sub-centimeter accuracy, with the exception of the southern portion of the boundary, which was hand-drawn in AutoCAD and verified in the field using a Thales Mobile Mapper CE GPS unit and has submeter accuracy.

The dirt access roads were digitized from a Google Earth aerial image in GIS and are estimated to have submeter accuracy.



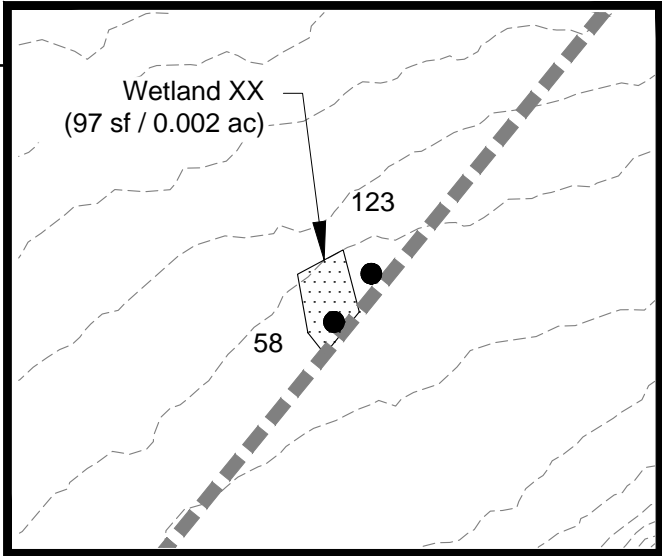
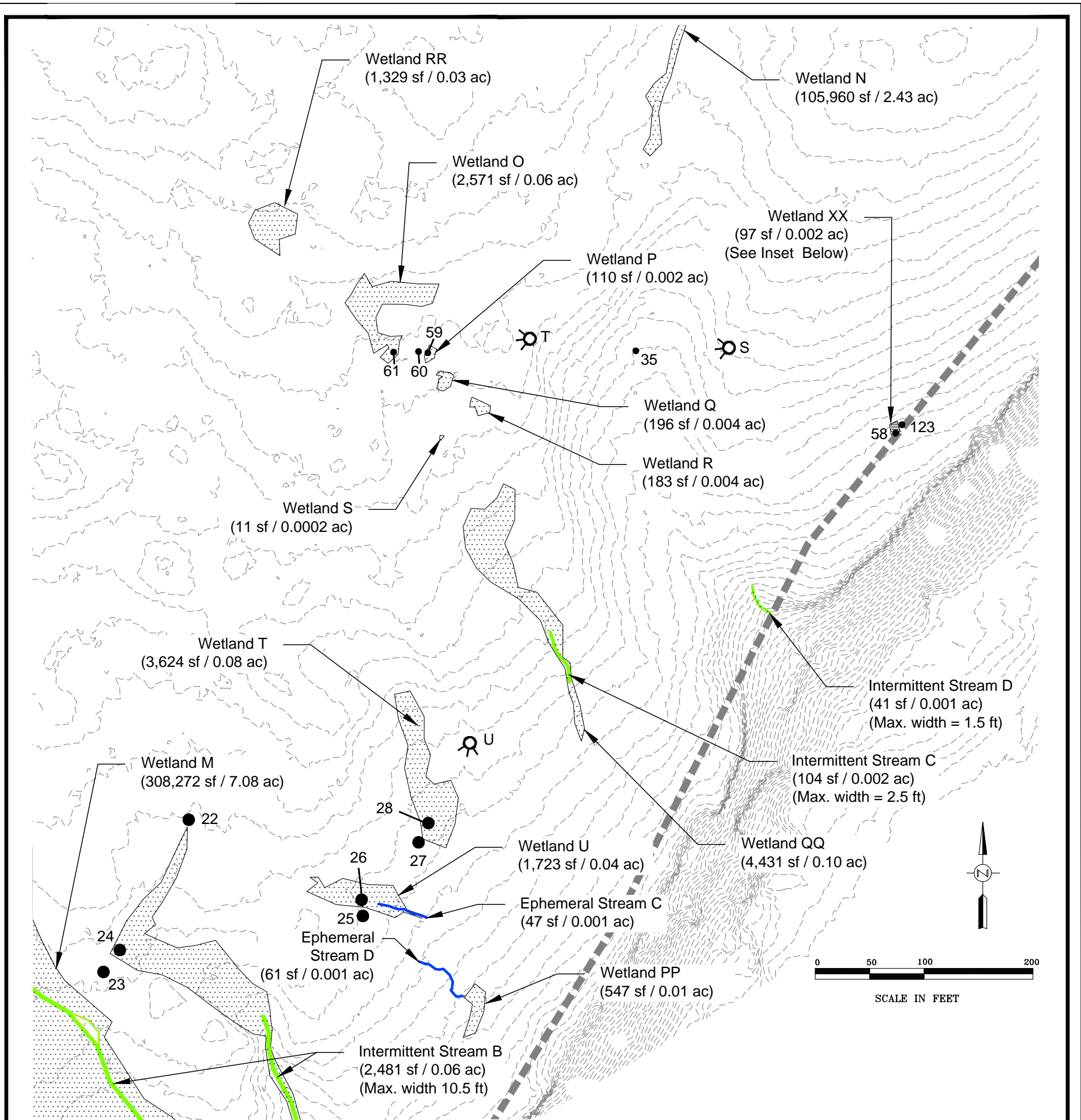
**See Revised Figure 6D
Dated 4/28/2021**

**DSL WD # 2019-0623
Approval Issued 10/15/2020
Approval Expires 10/15/2025**

Wetland Delineation
Watters Quarry - Saint Helens, Oregon

**FIGURE
6D**

10-1-2020



Inset of Wetland XX

The following were surveyed by Udell Engineering and Land Surveying and have sub-centimeter accuracy: Wetlands A-E, H-Y, Sample Points 1-14, 17-26, 28-35, 37-39, 42, 43, 45, 47-56, 58-62, 65-67, 74-81, and 86-90.

The following were surveyed using a Trimble Geo7h and have submeter accuracy: Wetlands F, G, Z-GG and Sample Points 57, 68-73, 91-125, all ephemeral and intermittent streams, and all culverts.

The following were placed on the wetland delineation map by hand and are estimated to be submeter accurate: Sample Points 15, 16, 27, 36, 40, 41, 44, 46, 63, 64, 82-85.

The Study Area boundary was surveyed by Udell Engineering and Land Surveying and has sub-centimeter accuracy, with the exception of the southern portion of the boundary, which was hand-drawn in AutoCAD and verified in the field using a Thales Mobile Mapper CE GPS unit and has submeter accuracy.

The dirt access roads were digitized from a Google Earth aerial image in GIS and are estimated to have submeter accuracy.

LEGEND

- Study Area Boundary (9,061,982 sf / 208 ac)
- Wetland Site Total (962,796 sf / 22.1 ac)
- Sample Point
- Photo Point
- Culvert
- Existing Contour (LiDAR 2 Foot Interval)
- Intermittent Stream Waters of the State/US (3,803 sf / 0.09 ac)
- Ephemeral Stream
- Roads

**See Revised Figure 6E
Dated 4/28/2021**



DSL WD # 2019-0623
Approval Issued 10/15/2020
Approval Expires 10/15/2025

Wetland Delineation
Watters Quarry - Saint Helens, Oregon

FIGURE
6E

9-23-2020

Attachment K

Wetland and Stream Functions and Values
Assessment



April 2024
Watters Quarry Phase II Project



Wetland and Stream Functions and Values Assessment

Prepared for Knife River Corporation—Northwest

April 2024
Watters Quarry Phase II Project

Wetland and Stream Functions and Values Assessment

Prepared for
Knife River Corporation—Northwest
32260 Old Highway 34
Tangent, Oregon 97389

Prepared by
Anchor QEA, LLC
6720 S Macadam Avenue, Suite 300
Portland, Oregon 97219

TABLE OF CONTENTS

1	Introduction	1
1.1	Assessment Methods.....	1
1.2	Assessment Approach.....	2
1.2.1	Pre-Project Assessment.....	2
1.2.2	Post-Project Assessment	2
2	Wetland Classification	3
3	Wetland Functions and Values Assessment.....	6
3.1	Wetland Assessment Areas	6
3.2	Assessment Methods.....	9
3.3	Pre-Project ORWAP Functions and Values Assessment Results.....	10
3.4	Post-Project ORWAP Functions and Values Assessment Results.....	18
4	Stream Classification.....	24
5	Stream Functions and Values Assessment	25
5.1	Stream Assessment Areas	25
5.2	Assessment Methods.....	26
5.3	Pre-Project SFAM Functions and Values Assessment Results	28
5.4	Post-Project Functions and Values Assessment Results	31
6	Summary	34
7	References	36

TABLES

Table 1	Wetland Classifications
Table 2	Wetland Assessment Areas Included in the Pre-Project Functions and Values Assessment
Table 3	Functions and Values Assessed by the Oregon Rapid Wetland Assessment Protocol Method
Table 4	Pre-Project Wetland Functions and Values Assessment Results
Table 5	Wetland Assessment Areas Included in the Post-Project Functions and Values Assessment
Table 6	Post-Project Wetland Functions and Values Assessment Results
Table 7	Stream Classifications

Table 8	Stream Assessment Areas Included in the Pre-Project Functions and Values Assessment
Table 9	Functions and Values Assessed by the Oregon Stream Function Assessment Method
Table 10	Pre-Project Stream Functions and Values Assessment Results
Table 11	Stream Assessment Areas Included in the Post-Project Functions and Values Assessment
Table 12	Post-Project Stream Functions and Values Assessment Results

FIGURES

Figure 1	Vicinity Map
Figure 2	Tax Lot Map
Figure 3	Proposed Project Overview Map
Figures 4a–4e	Pre-Project Functions and Values Wetland and Stream Assessment Areas
Figures 5a–5d	Post-Project Functions and Values Wetland and Stream Assessment Areas

APPENDICES

Appendix A	Pre-Project Wetland Functions and Values Assessment Forms
Appendix B	Pre-Project ORWAP Report
Appendix C	Post-Project Wetland Functions and Values Assessment Forms
Appendix D	Pre-Project Stream Functions and Values Assessment Forms
Appendix E	Pre-Project SFAM Reports
Appendix F	Post-Project Stream Functions and Values Assessment Forms
Appendix G	Post-Project SFAM Reports

ABBREVIATIONS

City	City of Saint Helens
CMP	Compensatory Mitigation Plan
CoverPg	cover page
Cowardin classification system	<i>Classification of Wetlands and Deepwater Habitats of the United States</i>
DSL	Oregon Department of State Lands
HGM	hydrogeomorphic
JPA	Joint Section 404/Removal-Fill Permit Application
N/A	not applicable
Oregon HGM classification system	<i>Guidebook for Hydrogeomorphic (HGM)-Based Assessment of Oregon Wetland and Riparian Sites: Statewide Classification and Profiles</i>
ORWAP	Oregon Rapid Wetland Assessment Protocol
PEM	palustrine emergent
PEMC	palustrine emergent, seasonally flooded wetland
PEME	palustrine emergent, seasonally flooded/saturated wetland
PFO	palustrine forested
PFOE	palustrine forested, seasonally flooded/saturated wetland
PHS	Pacific Habitat Services, Inc.
project	Watters Quarry Phase II project
project site	Watters Quarry Phase II project near the City of St. Helens, Columbia County, Oregon
PSS	palustrine scrub-shrub
PSSF	palustrine scrub-shrub, semi-permanently flooded wetland
R2UBH	riverine, lower perennial, unconsolidated bottom, permanently flooded
R4RB1	riverine, intermittent, rock bottom, bedrock
SFAM	Stream Function Assessment Method
USGS	U.S. Geological Survey

1 Introduction

Anchor QEA, LLC, wetland scientists conducted functions and values assessments for the delineated wetlands and other waters (e.g., streams) that would be affected by the Watters Quarry Phase II project (project) near the City of St. Helens (City), Columbia County, Oregon (project site; Figure 1). The assessment also included an evaluation of the expected functions and values provided by wetlands and a stream proposed to be created as part of the on-site Compensatory Mitigation Plan (CMP). The proposed quarry site and mitigation plan areas would occur on portions of tax lots 100, 300, 400, and 1600, and the land encompassed by these two areas is hereafter referred to as the project site (Figure 2). The purpose of these assessments is to support the Joint Section 404/Removal-Fill Permit Application (JPA) for the project, which will result in permanent impacts to on-site wetlands and streams, including some off-site portions, to facilitate quarry construction for surface mining of basalt for aggregate production (Figure 3). These functions and values assessments also support the CMP provided as an attachment to the JPA, which will mitigate for wetland and stream impacts on the project site.

1.1 Assessment Methods

The wetland functions and values assessments were conducted using the Oregon Rapid Wetland Assessment Protocol (ORWAP), a standardized protocol developed by the Oregon Department of State Lands (DSL) for rapidly assessing the functions and values of wetlands in Oregon. The *Manual for the Oregon Rapid Wetland Assessment Protocol (ORWAP)* (Adamus et al. 2016a) and the supporting website (Oregon Explorer: ORWAP Map and Stream Function Assessment Method [SFAM] Viewer; Rempel et al. 2015) were used to guide this assessment. ORWAP is applicable to wetlands of any type anywhere in Oregon and can be used to compare wetlands of different types.

Completing an ORWAP functions and values assessment consists of entering data into up to four spreadsheets, as applicable. The cover page (CoverPg) asks general information about the wetland location and characteristics and information on comprehensiveness of the site visit. The Office Data Form contains a series of questions that are answered remotely with data from the ORWAP Map Viewer prior to conducting a site visit. The Field Data Form for non-tidal wetlands or Tidal Data Form for tidal wetlands and the Stressors Data Form have a series of questions to be answered, if applicable, during a comprehensive site visit.

The stream functions and values assessments were conducted using the Oregon SFAM, a standardized protocol developed by DSL, the U.S. Army Corps of Engineers Portland District, Region 10 of the U.S. Environmental Protection Agency, and the Willamette Partnership. SFAM is part of a stream mitigation policy framework to guide compliance with the Federal Compensatory Mitigation Rule and the Oregon Removal-Fill Law. The supporting website is provided by Oregon Explorer SFAM Map Viewer (McCune et al. 2017). Developed for use in the State of Oregon, the

SFAM manual is presented in the document *Stream Function Assessment Method for Oregon*, Version 1.0 (Nadeau et al. 2018a), and the supporting scientific rationale is presented in the document *A Scientific Rationale in Support of the Stream Function Assessment Method for Oregon*, Version 1.0 (Nadeau et al. 2018b). SFAM is applicable to wadable streams of any type anywhere in Oregon and was developed for impact assessments and mitigation needs determination.

Completing the SFAM functions and values assessment consists of entering data into three spreadsheets. The CoverPg asks general information about the stream location and characteristics and assessment notes. The Values Form contains a series of questions that are answered remotely with data obtained from the SFAM Report generated by the SFAM Map Viewer prior to conducting a site visit. The Functions Form has a series of questions to be answered during a comprehensive site visit.

1.2 Assessment Approach

Assessments were performed for wetlands and perennial and intermittent streams within the proposed project boundary for the pre-project conditions and post-project conditions, including the proposed mitigation areas. The assessments determine both the level of functions and values currently being provided by wetlands and streams and the functional losses and gains that are expected to occur as a result of the proposed mitigation.

1.2.1 Pre-Project Assessment

The pre-project assessment was based on information presented in the 2019 wetland delineation report entitled *Wetland Delineation for Watters Quarry, St. Helens, Oregon* (Pacific Habitat Services, Inc. [PHS] 2019) and subsequent resubmittals (PHS 2020a, 2020b) and the 2021 wetland delineation memorandum entitled *Watters Quarry Expansion Project Wetland Delineation Addendum* (WD No. 2019-0623) (Anchor QEA 2021). It was also based on the conditions present on the site at the time of the 2019, 2020, and 2021 wetland and stream functions and values assessment site visits.

1.2.2 Post-Project Assessment

The post-project assessment was based on the expected future condition of the project site following the establishment of mining activities and having the CMP in place for 5 years. It was completed using the following assumptions:

- Wetlands and streams within the proposed quarry area have been completely impacted and no longer exist.
- Mining activities are in operation, including implementation of stormwater management practices and erosion control measures to support mining activities.
- Implementation of the CMP is complete and functioning as designed.

2 Wetland Classification

All delineated wetlands on the project site were classified according to two wetland classification systems: 1) the classification system under the U.S. Fish and Wildlife Service's *Classification of Wetlands and Deepwater Habitats of the United States* (Cowardin classification system; Cowardin et al. 1979); and 2) the hydrogeomorphic (HGM)-based classification system for Oregon presented in the *Guidebook for Hydrogeomorphic (HGM)-Based Assessment of Oregon Wetland and Riparian Sites: Statewide Classification and Profiles* (Oregon HGM classification system; Adamus 2001). Table 1 summarizes the HGM and Cowardin classifications for each wetland on the project site, including their off-site portions that extend beyond the project site boundaries (Figure 3).

Table 1
Wetland Classifications

Wetlands	Classification		Total Area	
	Cowardin Classification System ¹	Oregon HGM Classification System ²	Square Feet	Acres
Wetland A	PSSF	Slope	1,738	0.04
Wetland B	PFOE	Slope	200,288	4.6
Wetland C	PFOE	Slope	57,775	1.33
Wetland D	PFOE	Slope	39,025	0.89
Wetland E	PFOE	Slope	9,057	0.21
Wetland F	PEME	Depressional	1,018	0.02
Wetland G	PEME	Depressional	2,554	0.06
Wetland H	PEMC	Depressional	423	0.01
Wetland I	PEMC	Depressional	70	0.002
Wetland J	PEMC	Depressional	52	0.001
Wetland K	PEMC	Depressional	229	0.005
Wetland L	PEMC	Depressional	2,168	0.05
Wetland M	PFOE/PEMC	Depressional Outflow	308,272	7.08
Wetland N	PFOE	Depressional Outflow	105,960	2.43
Wetland O	PEMC	Depressional	2,571	0.06
Wetland P	PEMC	Depressional	110	0.002
Wetland Q	PEMC	Depressional	196	0.004
Wetland R	PEMC	Depressional	183	0.004
Wetland S	PEMC	Depressional	11	0.0002
Wetland T	PEMC	Depressional	3,624	0.08
Wetland U	PEMC	Depressional	1,723	0.04
Wetland Z	PFOE	Depressional	6,719	0.15
Wetland AA	PFOE	Depressional	9,700	0.22
Wetland BB	PFOE	Depressional	1,679	0.04
Wetland CC	PFOE	Depressional	10,981	0.25
Wetland DD	PFOE	Depressional	4,603	0.10
Wetland EE	PFOE	Depressional	16,362	0.37
Wetland FF	PFOE	Depressional	12,081	0.28
Wetland OO	PEMC	Depressional Outflow	1,243	0.03
Wetland PP	PEMC	Depressional Outflow	547	0.01
Wetland QQ	PEMC	Depressional Outflow	4,431	0.1
Wetland RR	PEMC	Depressional Outflow	1,329	0.03
Wetland TT	PEMC	Depressional Outflow	311	0.01
Wetland SS	PEMC	Depressional Outflow	25	0.01

Wetlands	Classification		Total Area	
	Cowardin Classification System ¹	Oregon HGM Classification System ²	Square Feet	Acres
Wetland XX	PEMC	Depressional Outflow	96	0.01
Wetland YY	PEMC	Depressional Outflow	996	0.02
Wetland ZZ	PFOE	Depressional	2,380	0.05
Wetland 1-A	PEME	Slope	1,077	0.025
Total Wetland Area			811,776	18.62

Notes:

- Cowardin classification system (Cowardin et al. 1979) wetland codes:
 PEMC: palustrine emergent, seasonally flooded wetland
 PEME: palustrine emergent, seasonally flooded/saturated wetland
 PFOE: palustrine forested, seasonally flooded/saturated wetland
 PSSF: palustrine scrub-shrub, semi-permanently flooded wetland
- Oregon HGM classification system (Adamus 2001)

3 Wetland Functions and Values Assessment

3.1 Wetland Assessment Areas

The assessment areas for the pre-project wetland functions and values assessment included the delineated portions of all wetlands on the project site and their off-site boundaries (Figures 4a through 4e). Only the wetlands that would be impacted by the proposed quarry or remaining on the project site were assessed. All other wetlands identified during the 2019 delineation (PHS 2020a, 2020b) and 2021 delineation (Anchor QEA 2021) are outside of the project site and would be avoided by the project. A functions and values assessment was also not completed for Wetland 1-A because it is not proposed to be impacted and is upslope from mitigation activities. The delineated wetlands were grouped into 21 separate assessment areas based on their wetland classifications (Section 2) and their ability to meet all the following criteria presented in the document *Guidance for Using the Oregon Rapid Wetland Assessment Protocol (ORWAP) in State and Federal Permit Programs* (DSL 2016):

1. They have the same predominant hydrology source.
2. They have a similar degree of disturbance.
3. They contain the same predominant mapped soil series.
4. They have similar abutting land uses.

The wetland assessment areas are summarized in Table 2 and briefly described in the sections that follow.

Table 2
Wetland Assessment Areas Included in the Pre-Project Functions and Values Assessment

Wetland Assessment Area	Wetlands Included in Assessment Area	Total Area	
		Square Feet	Acres
1	Wetland A	1,738	0.04
2	Wetlands B and TT	200,313	4.61
3	Wetland C	57,775	1.33
4	Wetlands D and E	48,082	1.1
5	Wetlands F and G	3,572	0.08
6	Wetlands H, I, J, and K	774	0.018
7	Wetland M	308,272	7.08
8	Wetland N	105,960	2.43
9	Wetlands L, SS, and XX	2,575	0.07
10	Wetlands O through T, QQ, and RR	12,455	0.28
11	Wetland U	1,723	0.04
12	Wetland Z	6,719	0.15
13	Wetland AA	9,700	0.22
14	Wetland BB	1,679	0.04
15	Wetland CC	10,981	0.25
16	Wetland DD	4,603	0.11
17	Wetlands EE and FF	28,443	0.65
18	Wetland PP	547	0.01
19	Wetland YY	996	0.02
20	Wetland ZZ	2,380	0.05
21	Wetland OO	1,243	0.1

Wetlands A, C, M, N, U, Z, AA through DD, PP, YY, ZZ, and OO were each evaluated as individual assessment areas. The remaining wetlands were grouped into separate assessment areas based on commonalities in their wetland classifications (Table 1), predominant hydrology source, degree of disturbance, predominant mapped soil series, and similar abutting land uses per the ORWAP guidance (DSL 2016).

Wetlands B and TT were grouped into a single assessment area because they are near each other with similar degrees of disturbance and similar abutting land uses (e.g., adjacent to past logging activities). They are also connected hydrologically by a small ephemeral stream (Ephemeral Stream B). Although Wetland B is classified as a palustrine forested, seasonally flooded/saturated wetland (PFOE) under the Cowardin classification system, it contains palustrine emergent, seasonally flooded wetland (PEMC) components similar to Wetland TT, which is surrounded by various tree and

shrub species that are also present in Wetland B. Wetland TT is classified as a Depressional Outflow wetland, and Wetland B is classified as a Slope wetland under the Oregon HGM classification system; however, Wetland B also contains topographic depressions in lower forms of its landscape that hold seasonal water, as well as a portion of the Ephemeral Stream B channel that conveys flow a short distance past Wetland TT before going subsurface. During high precipitation events, hydrology from Ephemeral Stream B sheet flows downslope and into Wetland C. The predominant hydrology source for both wetlands is precipitation with some groundwater discharge, and both overland flow and interflow from surrounding uplands. The predominant mapped soil series for both wetlands is Rock outcrop-Xerumbrepts complex, undulating.

Wetlands D and E were grouped into a single assessment area because they are near each other with similar degrees of disturbance and similar abutting land uses (e.g., adjacent to past logging activities). They are also connected hydrologically by a culvert that crosses an existing logging access road. Both wetland areas are classified as PFOE wetlands under the Cowardin classification system and Depressional wetlands under the Oregon HGM classification system. The predominant hydrology source for both wetlands is precipitation with some groundwater discharge, and both overland flow and interflow from surrounding uplands also contributing to some degree. The predominant mapped soil series for both wetlands is Rock outcrop-Xerumbrepts complex, undulating.

Wetlands F and G were grouped into a single assessment area because they are near each other with similar degrees of disturbance and similar abutting land uses (e.g., adjacent to past logging and agricultural activities). Both wetlands are classified as palustrine emergent, seasonally flooded/saturated (PEME) wetlands under the Cowardin classification system and Depressional wetlands under the Oregon HGM classification system. The predominant hydrology source for both wetlands is precipitation with some contribution from both overland flow and interflow from surrounding uplands. The predominant mapped soil series for Wetlands F and G is Rock outcrop-Xerumbrepts complex, undulating.

Wetlands H, I, and J were grouped into a single assessment area because they are near each other with similar degrees of disturbance (e.g., vehicle ruts) and similar abutting land uses (e.g., adjacent to past logging and mining activities). These wetlands are classified as PEMC wetlands under the Cowardin classification system and Depressional wetlands under the Oregon HGM classification system. The predominant hydrology source for these wetlands is precipitation and likely some overland flow and interflow from surrounding uplands. The predominant mapped soil series for Wetlands H, I, and J is Rock outcrop-Xerumbrepts complex, undulating.

Wetlands O through T and Wetlands QQ and RR were grouped into a single assessment area because they are near each other with similar degrees of disturbance (e.g., vehicle ruts) and similar abutting land uses (e.g., adjacent to past logging activities). These wetlands are classified as PEMC

wetlands under the Cowardin classification system and Depressional or Depressional Outflow wetlands under the Oregon HGM classification system. The predominant hydrology source for these wetlands is precipitation with some overland flow and interflow from surrounding uplands. The predominant mapped soil series for Wetlands O through T and Wetlands QQ and RR is Rock outcrop-Xerumbrepts complex, undulating.

Wetlands EE and FF were grouped into a single assessment area because they are near each other with similar degrees of disturbance (e.g., adjacent to vehicle ruts) and similar abutting land uses (e.g., adjacent to past logging activities). These wetlands are classified as PFOE wetlands under the Cowardin classification system and Depressional wetlands under the Oregon HGM classification system. The predominant hydrology source for these wetlands is precipitation with some overland flow and interflow from surrounding uplands. The predominant mapped soil series for Wetlands EE and FF is Rock outcrop-Xerumbrepts complex, undulating.

Wetlands L, SS, and XX were grouped into a single assessment area because they are all located along a rocky herbaceous bluff on slopes greater than 5% and have similar degrees of disturbance and similar abutting land uses (e.g., adjacent to past logging activities). These wetlands are classified as PEMC wetlands under the Cowardin classification system and Depressional or Depressional Outflow wetlands under the Oregon HGM classification system. The predominant hydrology source for these wetlands is precipitation with some overland flow and interflow from surrounding uplands. The predominant mapped soil series for Wetlands L, SS, and XX is Rock outcrop-Xerumbrepts complex, undulating.

3.2 Assessment Methods

As mentioned in Section 1.1, ORWAP (Adamus et al. 2016a, 2016b) was used to assess the functions and values of the existing wetlands and the proposed compensatory mitigation. ORWAP can be used to assess up to 16 of the most common functions and 18 of the most common values that are attributed to Oregon wetlands. However, for the purposes of permitting-related work, DSL requires that results of an ORWAP functions and values assessment are reported at the group level, which represents aggregated functions and values. Each group is represented by the highest-rated function with the highest-rated associated value rating. These groups and the functions and values that they encompass are shown in Table 3.

Table 3
Functions and Values Assessed by the Oregon Rapid Wetland Assessment Protocol Method

Primary Groups	Aggregated Functions Within Each Group	Function	Value
Hydrologic Function	Water Storage and Delay	X	X
Water Quality Support	Sediment Retention and Stabilization	X	X
	Phosphorus Retention	X	X
	Nitrate Removal and Retention	X	X
Fish Habitat	Anadromous Fish Habitat Support	X	X
	Resident Fish Habitat Support	X	X
Aquatic Habitat	Amphibian and Reptile Habitat	X	X
	Waterbird Nesting Habitat	X	X
	Waterbird Feeding Habitat	X	X
Ecosystem Support	Aquatic Invertebrate Habitat	X	X
	Songbird, Raptor, and Mammal Habitat	X	X
	Water Cooling	X	X
	Native Plant Diversity	X	X
	Pollinator Habitat	X	X
	Organic Nutrient Export	X	N/A
Carbon Sequestration		X	N/A
Public Use and Recognition		N/A	X
Other Attributes			
Wetland Sensitivity		N/A	X
Wetland Ecological Condition		N/A	X
Wetland Stressors		N/A	X

Note:
NA: Not Applicable

Except for the Organic Nutrient Export, Carbon Sequestration, Public Use and Recognition, Wetland Sensitivity, Wetland Ecological Condition, and Wetland Stressors attributes, ORWAP generates both a functional effectiveness (i.e., function) score and a relative value of function (i.e., value) score for each attribute. For the Organic Nutrient Export function and Carbon Sequestration attribute, only a function score is provided by the model; for the Public Use and Recognition, Wetland Sensitivity, Wetland Ecological Condition, and Wetland Stressors attributes, only value scores are provided.

3.3 Pre-Project ORWAP Functions and Values Assessment Results

The results of the ORWAP functions and values assessments for the 21 wetland assessment areas under pre-project (i.e., existing) conditions are summarized in the following sections. Results of the pre-project ORWAP functions and values assessment scores and ratings are summarized in Table 4. Copies of the pre-project ORWAP functions and values assessment data forms are provided in

Appendix A, and copies of the Oregon Explorer ORWAP Report and the U.S. Geological Survey (USGS) StreamStats Report are provided in Appendix B.

Nearly half of the wetland assessment areas received their highest scores for providing hydrologic functions and water quality support. Exceptions for this include Assessment Area 1 (Wetland A), Assessment Area 2 (Wetlands B and TT), Assessment Area 3 (Wetland C), Assessment Area 4 (Wetlands D and E), Assessment Area 7 (Wetland M), Assessment Area 8 (Wetland N), Assessment Area 9 (Wetlands L, SS, and XX), Assessment Area 11 (Wetland U), Assessment Area 18 (Wetland PP), Assessment Area 19 (Wetland YY), and Assessment Area 21 (Wetland OO), which received more moderate to low scores for hydrologic and water quality functional groups. Site characteristics that contribute to the higher scores and subsequent performance of hydrologic and water quality include seasonal inundation, depth and duration of ponding, restricted outflow, and the presence of herbaceous and woody vegetation. Factors that limit the performance of these functions include the lack of permanent inundation, being located along a slope that drains water, limited areas of open ponded water, and the lack of dense herbaceous vegetation. None of the assessment areas are suitable for providing fish habitat based on all receiving lower scores for that group of functions due to the lack of permanent inundation.

All assessment areas are providing high functioning aquatic habitat for amphibians, reptiles, and waterbirds based on all receiving higher scores for this functional group. Factors that contribute to this function include the extent of adjacent perennial cover, the presence of other adjacent wetlands, the extent of ponded surface water, and the absence of repeated disturbance from activities such as mowing, grazing, or harvesting.

Most assessment areas are also best at providing ecosystem support, with all receiving higher scores for this functional group except for Assessment Area 5 (Wetlands F and G), Assessment Area 6 (Wetlands H, I, J, and K), Assessment Area 10 (Wetlands O through T, QQ, and RR), Assessment Area 19 (Wetland YY), and Assessment Area 21 (Wetland OO), which received more moderate scores. Site characteristics that contribute to the performance of these functions include the presence of native herbaceous and woody vegetation, the extent of adjacent perennial cover providing shading and upland habitat, and the presence of seasonally ponded water with a range of depth classes. Factors that limit the performance of this function include the lack of permanent inundation, limited nearby development, and the presence of invasive plant species.

Regarding the values of these functional groups, the hydrologic functions and water quality support groups scored the highest for all assessment areas. Factors that increase these value scores include the wetland's ability to improve water quality by trapping sediments and pollutants, store water, reduce the severity of downstream flooding, and sequester carbon. The aquatic habitat group had lower to moderate value scores due to the limited need for permanent inundated areas to support amphibians and reptiles and waterbirds with the ample presence of permanently ponded areas in the

vicinity, such as along the Columbia River. The ecosystem support group had lower value scores for all assessment areas except for Assessment Area 7 (Wetland M), Assessment Area 10 (Wetlands O through T, QQ, and RR), and Assessment Area 18 (Wetland PP), which received higher scores for this functional group. Factors that reduce the value scores for the ecosystem support group include the limited ability of the wetlands to provide essential goods and services due to the lack of permanent waterbodies for fish habitat and limited contributions of nutrients and toxins from upslope. Site conditions that increase the value scores of this functional group include the presence of native plant species that support biodiversity in the region. For the fish habitat group, all assessment areas received low scores for the values of these functions due to the lack of permanent inundation.

For carbon sequestration, most assessment areas are providing this function at moderate levels, except for Assessment Area 4 (Wetlands D and E), Assessment Area 9 (Wetlands L, SS, and XX), Assessment Area 10 (Wetlands O through T and Wetlands QQ and RR), Assessment Area 11 (Wetland U), Assessment Area 18 (Wetland PP), Assessment Area 19 (Wetland YY), and Assessment Area 21 (Wetland OO), which are providing this function at a lower level. For the other attributes of Wetland Sensitivity, Wetland Ecological Condition, and Wetland Stressors, all assessment areas received moderate to lower scores, except for Assessment Area 7 (Wetland M), Assessment Area 9 (Wetlands L, SS, and XX), and Assessment Area 10 (Wetlands O through T and Wetlands QQ and RR). These three assessment areas received a higher rating for the wetland sensitivity attribute due to containing the native wet prairie wetland type. Assessment Area 11 (Wetland U) and Assessment Area 19 (Wetland PP), which are also native wet prairie wetland types both had a rating proximity break of "MH" for the Sensitivity attribute, indicating a close proximity break between the moderate and higher ratings. All assessment areas received low value scores for the Public Use and Recognition function due to limited public access and use for recreation or consumption (e.g., fishing, hunting).

Table 4
Pre-Project Wetland Functions and Values Assessment Results

Groups ¹		Assessment Area and HGM Wetland Classification											
		Assessment Area 1 Wetland A (Slope)			Assessment Area 2 Wetlands B and TT (Slope/Depressional Outflow)			Assessment Area 3 Wetland C (Slope)			Assessment Area 4 Wetlands D and E (Slope)		
		Highest Rated Function	Score	Rating	Highest Rated Function	Score	Rating	Highest Rated Function	Score	Rating	Highest Rated Function	Score	Rating
Hydrologic Function	Function	Water Storage and Delay	4.28	Moderate ³	Water Storage and Delay	4.25	Moderate ³	Water Storage and Delay	4.62	Moderate	Water Storage and Delay	4.89	Moderate
	Value		7.50	Higher		7.50	Higher		7.50	Higher		7.50	Higher
Water Quality Support	Function	Sediment Retention and Stabilization	3.12	Lower ³	Sediment Retention and Stabilization	4.28	Moderate	Sediment Retention and Stabilization	5.67	Moderate	Sediment Retention and Stabilization	4.53	Moderate
	Value		7.63	Higher		6.77	Higher		7.30	Higher		6.77	Higher
Fish Habitat	Function	Anadromous Fish Habitat	0.00	Lower	Anadromous Fish Habitat	0.00	Lower	Anadromous Fish Habitat	0.00	Lower	Anadromous Fish Habitat	0.00	Lower
	Value		0.00	Lower		0.00	Lower		0.00	Lower		0.00	Lower
Aquatic Habitat	Function	Waterbird Nesting Habitat	7.40	Higher ²	Waterbird Nesting Habitat	7.72	Higher	Waterbird Nesting Habitat	7.72	Higher	Waterbird Nesting Habitat	8.35	Higher
	Value		1.72	Moderate ³		1.72	Moderate ³		1.72	Moderate ³		1.72	Moderate ³
Ecosystem Support	Function	Native Plant Diversity	7.25	Higher ²	Organic Nutrient Export	7.28	Higher ²	Organic Nutrient Export	7.13	Higher ²	Native Plant Diversity	7.70	Higher
	Value		1.67	Lower		N/A			N/A			1.98	Lower
Additional Attributes													
Carbon Sequestration	Function		4.12	Moderate ³		5.26	Moderate		5.56	Moderate		3.71	Lower ³
Public Use and Recognition	Value		1.76	Lower		1.82	Lower		1.82	Lower		1.80	Lower
Wetland Sensitivity			1.14	Lower		0.42	Lower		1.03	Lower		0.45	Lower
Wetland Ecological Condition			2.99	Moderate ³		2.32	Lower ³		2.32	Lower ³		1.61	Lower
Wetland Stressors			3.33	Lower ³		3.33	Lower ³		5.00	Moderate		3.33	Lower ³

Notes:

1. Groups are a "roll-up" of individual functions and their associated values organized into thematic categories. For any assessed wetland, the specific function selected to represent a function group is that with the highest-rated function and the highest-rated associated value from among the group's members.
2. Rating has a Rating Break Proximity of "MH," which indicates that the rating score is within the statistical confidence interval of the break between Moderate and Higher ratings.
3. Rating has a Rating Break Proximity of "LM," which indicates that the rating score is within the statistical confidence interval of the break between Lower and Moderate ratings.

Table 4
Pre-Project Wetland Functions and Values Assessment Results

Groups ¹		Assessment Area and HGM Wetland Classification											
		Assessment Area 5 Wetlands F and G (Depressional)			Assessment Area 6 Wetlands H, I, J, and K (Depressional)			Assessment Area 7 Wetland M (Depressional Outflow)			Assessment Area 8 Wetland N (Depressional Outflow)		
		Highest Rated Function	Score	Rating	Highest Rated Function	Score	Rating	Highest Rated Function	Score	Rating	Highest Rated Function	Score	Rating
Hydrologic Function	Function	Water Storage and Delay	10.00	Higher	Water Storage and Delay	10.00	Higher	Water Storage and Delay	3.08	Lower ³	Water Storage and Delay	4.19	Moderate ³
	Value		7.50	Higher		7.50	Higher		7.50	Higher		7.50	Higher
Water Quality Support	Function	Sediment Retention and Stabilization	10.00	Higher	Sediment Retention and Stabilization	10.00	Higher	Sediment Retention and Stabilization	4.01	Moderate ³	Sediment Retention and Stabilization	3.84	Moderate ³
	Value		6.77	Higher		6.77	Higher		7.30	Higher		6.77	Higher
Fish Habitat	Function	Anadromous Fish Habitat	0.00	Lower	Anadromous Fish Habitat	0.00	Lower	Anadromous Fish Habitat	0.00	Lower	Anadromous Fish Habitat	0.00	Lower
	Value		0.00	Lower		0.00	Lower		0.00	Lower		0.00	Lower
Aquatic Habitat	Function	Amphibian and Reptile Habitat	7.56	Higher	Waterbird Nesting Habitat	7.74	Higher	Waterbird Nesting Habitat	8.20	Higher	Waterbird Nesting Habitat	8.16	Higher
	Value		2.32	Lower		1.72	Moderate ³		1.72	Moderate ³		1.72	Moderate ³
Ecosystem Support	Function	Pollinator Habitat	5.43	Moderate	Aquatic Invertebrate Habitat	6.35	Moderate ²	Native Plant Diversity	8.12	Higher	Organic Nutrient Export	6.94	Higher ²
	Value		1.03	Lower		1.03	Lower		10.00	Higher		N/A	
Additional Attributes													
Carbon Sequestration	Function		5.07	Moderate		4.14	Moderate ³		3.96	Moderate ³		5.16	Moderate
Public Use and Recognition	Value		1.76	Lower		1.88	Lower		1.81	Lower		1.81	Lower
Wetland Sensitivity			1.35	Lower		1.45	Lower		5.47	Higher		0.67	Lower
Wetland Ecological Condition			4.07	Moderate		1.21	Lower		3.53	Moderate ³		3.43	Moderate ³
Wetland Stressors			5.00	Moderate		5.00	Moderate		3.33	Lower ³		3.33	Lower ³

Notes:

1. Groups are a "roll-up" of individual functions and their associated values organized into thematic categories. For any assessed wetland, the specific function selected to represent a function group is that with the highest-rated function and the highest-rated associated value from among the group's members.
2. Rating has a Rating Break Proximity of "MH," which indicates that the rating score is within the statistical confidence interval of the break between Moderate and Higher ratings.
3. Rating has a Rating Break Proximity of "LM," which indicates that the rating score is within the statistical confidence interval of the break between Lower and Moderate ratings.

Table 4
Pre-Project Wetland Functions and Values Assessment Results

Groups ¹		Assessment Area and HGM Wetland Classification											
		Assessment Area 9 Wetlands L, SS, and XX (Depressional/Depressional Outflow)			Assessment Area 10 Wetlands O through T, QQ, and RR (Depressional/Depressional Outflow)			Assessment Area 11 Wetland U (Depressional)			Assessment Area 12 Wetland Z (Depressional)		
		Highest Rated Function	Score	Rating	Highest Rated Function	Score	Rating	Highest Rated Function	Score	Rating	Highest Rated Function	Score	Rating
Hydrologic Function	Function	Water Storage and Delay	3.97	Lower ³	Water Storage and Delay	10.00	Higher	Water Storage and Delay	4.25	Moderate ³	Water Storage and Delay	10.00	Higher
	Value		7.50	Higher		7.50	Higher		7.50	Higher		7.50	Higher
Water Quality Support	Function	Sediment Retention and Stabilization	2.78	Lower	Sediment Retention and Stabilization	10.00	Higher	Sediment Retention and Stabilization	2.88	Lower	Sediment Retention and Stabilization	10.00	Higher
	Value		6.77	Higher		6.77	Higher		6.77	Higher		6.77	Higher
Fish Habitat	Function	Anadromous Fish Habitat	0.00	Lower	Anadromous Fish Habitat	0.00	Lower	Anadromous Fish Habitat	0.00	Lower	Anadromous Fish Habitat	0.00	Lower
	Value		0.00	Lower		0.00	Lower		0.00	Lower		0.00	Lower
Aquatic Habitat	Function	Amphibian and Reptile Habitat	7.86	Higher	Amphibian and Reptile Habitat	7.97	Higher	Amphibian and Reptile Habitat	7.89	Higher	Waterbird Nesting Habitat	7.52	Higher
	Value		1.11	Lower		1.11	Lower		1.11	Lower		1.72	Moderate ³
Ecosystem Support	Function	Organic Nutrient Export	7.48	Higher	Native Plant Diversity	6.50	Moderate ²	Organic Nutrient Export	7.19	Higher ²	Native Plant Diversity	6.83	Higher ²
	Value		N/A			10.00	Higher		N/A			1.49	Lower
Additional Attributes													
Carbon Sequestration	Function		3.24	Lower		3.22	Lower		2.75	Lower		5.59	Moderate
Public Use and Recognition	Value		1.88	Lower		1.88	Lower		1.88	Lower		1.88	Lower
Wetland Sensitivity			4.53	Higher ²		4.78	Higher ²		4.43	Moderate ²		2.11	Lower ³
Wetland Ecological Condition			0.72	Lower		0.72	Lower		0.72	Lower		2.99	Moderate ³
Wetland Stressors			3.33	Lower ³		5.00	Moderate		3.33	Lower ³		5.00	Moderate

Notes:

1. Groups are a "roll-up" of individual functions and their associated values organized into thematic categories. For any assessed wetland, the specific function selected to represent a function group is that with the highest-rated function and the highest-rated associated value from among the group's members.
2. Rating has a Rating Break Proximity of "MH," which indicates that the rating score is within the statistical confidence interval of the break between Moderate and Higher ratings.
3. Rating has a Rating Break Proximity of "LM," which indicates that the rating score is within the statistical confidence interval of the break between Lower and Moderate ratings.

Table 4
Pre-Project Wetland Functions and Values Assessment Results

Groups ¹		Assessment Area and HGM Wetland Classification											
		Assessment Area 13 Wetland AA (Depressional)			Assessment Area 14 Wetland BB (Depressional)			Assessment Area 15 Wetland CC (Depressional)			Assessment Area 16 Wetland DD (Depressional)		
		Highest Rated Function	Score	Rating	Highest Rated Function	Score	Rating	Highest Rated Function	Score	Rating	Highest Rated Function	Score	Rating
Hydrologic Function	Function	Water Storage and Delay	10.00	Higher	Water Storage and Delay	10.00	Higher	Water Storage and Delay	10.00	Higher	Water Storage and Delay	10.00	Higher
	Value		7.50	Higher		7.50	Higher		7.50	Higher		7.50	Higher
Water Quality Support	Function	Sediment Retention and Stabilization	10.00	Higher	Sediment Retention and Stabilization	10.00	Higher	Sediment Retention and Stabilization	10.00	Higher	Sediment Retention and Stabilization	10.00	Higher
	Value		6.98	Higher		6.98	Higher		6.98	Higher		6.98	Higher
Fish Habitat	Function	Anadromous Fish Habitat	0.00	Lower	Anadromous Fish Habitat	0.00	Lower	Anadromous Fish Habitat	0.00	Lower	Anadromous Fish Habitat	0.00	Lower
	Value		0.00	Lower		0.00	Lower		0.00	Lower		0.00	Lower
Aquatic Habitat	Function	Waterbird Nesting Habitat	7.56	Higher	Waterbird Nesting Habitat	8.27	Higher	Waterbird Nesting Habitat	7.97	Higher	Waterbird Nesting Habitat	7.81	Higher
	Value		1.72	Moderate ³		1.72	Moderate ³		1.72	Moderate ³		1.72	Moderate ³
Ecosystem Support	Function	Aquatic Invertebrate Habitat	7.38	Higher ²	Aquatic Invertebrate Habitat	8.69	Higher	Aquatic Invertebrate Habitat	8.24	Higher	Aquatic Invertebrate Habitat	7.85	Higher
	Value		1.09	Lower		1.07	Lower		1.11	Lower		1.09	Lower
Additional Attributes													
Carbon Sequestration	Function		5.93	Moderate ²		4.90	Moderate		4.75	Moderate		4.71	Moderate
Public Use and Recognition	Value		1.88	Lower		1.88	Lower		1.81	Lower		1.88	Lower
Wetland Sensitivity			2.75	Moderate ³		2.19	Lower ³		2.90	Moderate		2.02	Lower ³
Wetland Ecological Condition			3.53	Moderate ³		2.44	Lower ³		2.74	Lower ³		3.04	Moderate ³
Wetland Stressors			5.00	Moderate		5.00	Moderate		5.00	Moderate		5.00	Moderate

Notes:

1. Groups are a "roll-up" of individual functions and their associated values organized into thematic categories. For any assessed wetland, the specific function selected to represent a function group is that with the highest-rated function and the highest-rated associated value from among the group's members.
2. Rating has a Rating Break Proximity of "MH," which indicates that the rating score is within the statistical confidence interval of the break between Moderate and Higher ratings.
3. Rating has a Rating Break Proximity of "LM," which indicates that the rating score is within the statistical confidence interval of the break between Lower and Moderate ratings.

Table 4
Pre-Project Wetland Functions and Values Assessment Results

Groups ¹		Assessment Area and HGM Wetland Classification														
		Assessment Area 17 Wetlands EE and FF (Depressional)			Assessment Area 18 Wetland PP (Depressional Outflow)			Assessment Area 19 Wetland YY (Depressional Outflow)			Assessment Area 20 Wetland ZZ (Depressional)			Assessment Area 21 Wetland OO (Depressional Outflow)		
		Highest Rated Function	Score	Rating	Highest Rated Function	Score	Rating	Highest Rated Function	Score	Rating	Highest Rated Function	Score	Rating	Highest Rated Function	Score	Rating
Hydrologic Function	Function	Water Storage and Delay	10.00	Higher	Water Storage and Delay	4.37	Moderate ³	Water Storage and Delay	4.41	Moderate ³	Water Storage and Delay	10.00	Higher	Water Storage and Delay	4.33	Moderate ³
	Value		7.50	Higher		7.50	Higher		7.50	Higher		7.50	Higher		7.50	Higher
Water Quality Support	Function	Sediment Retention and Stabilization	10.00	Higher	Sediment Retention and Stabilization	3.11	Lower ³	Sediment Retention and Stabilization	3.10	Lower ³	Sediment Retention and Stabilization	10.00	Higher	Sediment Retention and Stabilization	3.07	Lower ³
	Value		6.98	Higher		7.50	Higher		6.98	Higher		6.98	Higher		6.77	Higher
Fish Habitat	Function	Anadromous Fish Habitat	0.00	Lower	Anadromous Fish Habitat	0.00	Lower	Anadromous Fish Habitat	0.00	Lower	Anadromous Fish Habitat	0.00	Lower	Anadromous Fish Habitat	0.00	Lower
	Value		0.00	Lower		0.00	Lower		0.00	Lower		0.00	Lower		0.00	Lower
Aquatic Habitat	Function	Waterbird Nesting Habitat	7.99	Higher	Amphibian and Reptile Habitat	7.89	Higher	Waterbird Nesting Habitat	7.87	Higher	Waterbird Nesting Habitat	7.32	Higher ²	Waterbird Nesting Habitat	7.79	Higher
	Value		1.72	Moderate ³		1.11	Lower		1.72	Moderate ³		1.72	Moderate ³		1.72	Moderate ³
Ecosystem Support	Function	Water Cooling	9.83	Higher	Native Plant Diversity	6.66	Higher ²	Organic Nutrient Export	5.66	Moderate	Aquatic Invertebrate Habitat	7.39	Higher ²	Organic Nutrient Export	6.12	Moderate ²
	Value		0.00	Lower		10.00	Higher		N/A			1.06	Lower		N/A	
Additional Attributes																
Carbon Sequestration	Function		4.98	Moderate		2.75	Lower		2.89	Lower		4.47	Moderate		2.95	Lower ³
Public Use and Recognition	Value		1.88	Lower		1.88	Lower		1.88	Lower		1.88	Lower		1.88	Lower
Wetland Sensitivity			2.27	Moderate ³		4.43	Moderate ²		0.30	Lower		2.67	Moderate ³		4.33	Moderate ²
Wetland Ecological Condition			1.46	Lower		0.72	Lower		2.25	Lower		2.94	Moderate ³		1.51	Lower
Wetland Stressors			5.00	Moderate		3.33	Lower ³		3.33	Lower ³		5.00	Moderate		3.33	Lower ³

Notes:

1. Groups are a "roll-up" of individual functions and their associated values organized into thematic categories. For any assessed wetland, the specific function selected to represent a function group is that with the highest-rated function and the highest-rated associated value from among the group's members.
2. Rating has a Rating Break Proximity of "MH," which indicates that the rating score is within the statistical confidence interval of the break between Moderate and Higher ratings.
3. Rating has a Rating Break Proximity of "LM," which indicates that the rating score is within the statistical confidence interval of the break between Lower and Moderate ratings.

3.4 Post-Project ORWAP Functions and Values Assessment Results

Under post-project conditions (i.e., the expected future condition of the project site [Section 1.2.2]), all wetlands within the proposed mining site would cease to exist, and therefore would no longer perform any wetland functions or provide values for those functions (Figure 3). Under post-project conditions, the CMP would be fully implemented and functioning as designed, including the enhancement of Wetlands A, B, C, F, G, and TT, and the creation of Wetlands M-1, M-2, M-3, M-4, M-5, M-6, M-7, M-8, M-9, and M-10 (Figures 5a through 5d). Wetlands A, B, C, F, G, and TT are not proposed to be impacted but were included in the analysis to account for the enhancement actions (e.g., invasive species removal and native plantings) proposed as part of the mitigation design and changes to surrounding habitats following mitigation construction. No mitigation credit is being proposed for the enhancement portion, but the enhancement is expected to increase the functions of the enhanced wetlands and increase the success of the created wetlands by reducing invasive seed sources. The portion of Wetland M remaining outside the proposed mining area was also included in the analysis because of the proposed changes to the portion proposed to be directly impacted, its contributing hydrology, and surrounding habitats following mitigation construction. Wetlands U, Z, DD, EE, FF, OO, and PP are also not proposed to be impacted but were included in the analysis due to the adjacent habitat changes related to the development of the mitigation areas. Wetland 1-A was not considered in the analysis because it is located upslope from the mitigation areas and not proposed to be impacted or enhanced and, therefore, is expected to function the same as existing conditions.

The following assumptions were used in the post-project conditions functions and values assessment:

- The CMP is functioning as designed and in place for a minimum of 5 years.
- Existing soils and underlying basalt are graded to create conditions that capture direct precipitation, groundwater, surface runoff, and tributary inputs and have established wetland hydrology.
- Select excavated areas have been backfilled with clay or similar materials that have prevented captured water from infiltrating fissures in the bedrock.
- Hydrology from Perennial Stream 1-A and surrounding upland areas is captured by the created Perennial Stream MS-1 and associated created fringe Slope/Depressional Outflow palustrine forested/palustrine scrub-shrub/palustrine emergent (PFO/PSS/PEM) wetland complex (Wetland M-1) and routed into some of the remaining portions of Wetland M and the Intermittent Stream B channel similar to existing conditions.
- Hydrology from groundwater and upland slopes is captured and directed into created Depressional PFO/PSS/PEM wetland areas (Wetland M-2).
- Hydrology from Ephemeral Stream B and upland slopes is captured and directed into created Slope/Depressional PFO/PSS/PEM wetland areas (Wetland M-3).

- Depressional wet prairie/wet rock outcrop habitat (Wetlands M-4, M-5, M-6, M-7, M-8, M-9, and M-10) is successfully created on shallow rocky bluffs similar to existing wet prairie/wet rock outcrop habitat on the project site.
- Native upland soil from the impact area has established hydric soils for created wetland areas and sufficient upland soil to support woody species in riparian areas.
- Native herbaceous, scrub-shrub, and tree species are established and providing diverse wildlife habitat similar to the native wet prairie/wet rock outcrop, emergent, scrub-shrub, and forested wetlands impacted by the quarry.
- Established depressions in created wetlands have increased water storage and delay functions.
- Established microtopography in wetlands has enhanced hydrological and ecosystem functions.
- Invasive species have been actively managed during regular mitigation area maintenance by using hand pulling, flaming, shading, and spot-spraying methods.

Table 5 provides a summary of the wetland assessment areas under post-project conditions (Figures 5a through 5d).

**Table 5
Wetland Assessment Areas Included in the Post-Project Functions and Values Assessment**

Wetland Assessment Area	Wetlands Included in Assessment Area	Classification System		Total Area	
		Cowardin ¹	Oregon HGM	Square Feet	Acres
1	Enhanced Wetland A	PSSF	Slope	1,738	0.04
2	Enhanced Wetland B	PFOE	Slope	200,288	4.6
	Enhanced Wetland TT	PEMC	Depressional Outflow	25	0.01
3	Enhanced Wetland C	PFOE	Slope	57,775	1.33
4	Enhanced Wetland F	PEME	Depressional	1,018	0.02
	Enhanced Wetland G	PEME	Depressional	2,554	0.06
5	Remaining Wetland M	PFO/PSS/PEM	Depressional Outflow	61,812	1.42
6	Existing Wetland U	PEMC	Depressional	1,723	0.04
7	Existing Wetland Z	PFOE	Depressional	6,719	0.15
8	Existing Wetland DD	PFOE	Depressional	4,603	0.10
9	Existing Wetland EE and FF	PFOE	Depressional	28,443	0.65
10	Existing Wetland OO	PEMC	Depressional Outflow	1,243	0.03
11	Existing Wetland PP	PEMC	Depressional Outflow	547	0.01
12	Created Wetland M-1	PFO/PSS/PEM	Slope/Depressional Outflow	386,725	8.88
13	Created Wetland M-2	PFO/PSS/PEM	Depressional	22,152	0.51
14	Created Wetland M-3	PFO/PSS/PEM	Slope/Depressional	332,243	7.63

Wetland Assessment Area	Wetlands Included in Assessment Area	Classification System		Total Area	
		Cowardin ¹	Oregon HGM	Square Feet	Acres
15	Created Wetlands M-4, M-5, M-6, M-7, M-8, M-9, and M-10	PEM (ARSC)	Depressional	56,421	1.30
Total Existing, Remaining, and Enhanced Wetlands				368,488	8.46
Total Created Wetlands				797,541	18.32
Total Assessment Area				1,166,029	26.78

Notes:

- Cowardin classification system (Cowardin et al. 1979) wetland codes:
 PEM: palustrine emergent
 PFO: palustrine forested
 PSS: palustrine scrub-shrub

The results of the ORWAP functions and values assessments for the wetland assessment areas under post-project conditions are summarized in Table 6. Copies of the post-project ORWAP functions and values assessment data forms are provided in Appendix C.

Under post-project conditions, the existing wetlands, enhanced wetlands, and the remaining portion of Wetland M are predicted to perform at similar levels or better compared to pre-project conditions for all functional groups, and the values of those functions are also anticipated to be similar or higher. Likewise, the created wetlands are designed to function and provide values for those functions at levels commensurate with pre-project conditions. Factors providing the functional lift for the enhanced and created wetlands include the removal of invasive species, the planting of native woody species, the creation of forested and wet prairie wetlands, the provision of increased water storage and treatment, and the replacement of locally important ecological functions and services that will be permanently lost at the impact site. For the existing wetlands proposed to not be impacted by the project, the changes in surrounding habitat had minimal effect on their post-project condition. The primary change is a reduction in adjacent perennial cover for some wetlands due to the development of the mining area. However, as part of the overall mitigation strategy of achieving a surrounding diverse native plant community with minimal invasives, a minimum 50-foot-wide buffer will be established between the remaining wetlands and mitigation areas and the mining area.

Table 6
Post-Project Wetland Functions and Values Assessment Results

Groups ¹		Assessment Area and HGM Wetland Classification														
		Assessment Area 1 Wetland A (Slope)			Assessment Area 2 Wetlands B and TT (Slope/Depressional Outflow)			Assessment Area 3 Wetland C (Slope)			Assessment Area 4 Wetlands F and G (Depressional)			Assessment Area 5 Remaining Wetland M (Slope/Depressional Outflow)		
		Highest Rated Function	Score	Rating	Highest Rated Function	Score	Rating	Highest Rated Function	Score	Rating	Highest Rated Function	Score	Rating	Highest Rated Function	Score	Rating
Hydrologic Function	Function	Water Storage and Delay	4.36	Moderate ³	Water Storage and Delay	4.25	Moderate ³	Water Storage and Delay	4.62	Moderate	Water Storage and Delay	10.00	Higher	Water Storage and Delay	3.02	Lower
	Value		7.50	Higher		7.50	Higher		7.50	Higher		7.50	Higher		7.50	Higher
Water Quality Support	Function	Sediment Retention and Stabilization	3.16	Lower ³	Sediment Retention and Stabilization	4.28	Moderate	Sediment Retention and Stabilization	5.67	Moderate	Sediment Retention and Stabilization	10.00	Higher	Sediment Retention and Stabilization	3.44	Lower
	Value		7.47	Higher		6.77	Higher		7.30	Higher		6.77	Higher		7.30	Higher
Fish Habitat	Function	Anadromous Fish Habitat	0.00	Lower	Anadromous Fish Habitat	0.00	Lower	Anadromous Fish Habitat	0.00	Lower	Anadromous Fish Habitat	0.00	Lower	Anadromous Fish Habitat	0.00	Lower
	Value		0.00	Lower		0.00	Lower		0.00	Lower		0.00	Lower		0.00	Lower
Aquatic Habitat	Function	Waterbird Nesting Habitat	7.40	Higher ²	Waterbird Nesting Habitat	7.85	Higher	Waterbird Nesting Habitat	7.67	Higher	Amphibian and Reptile Habitat	7.67	Higher	Waterbird Nesting Habitat	7.84	Higher
	Value		1.72	Moderate ³		1.72	Moderate ³		1.72	Moderate ³		2.33	Lower		1.72	Moderate ³
Ecosystem Support	Function	Native Plant Diversity	7.85	Higher	Organic Nutrient Export	7.28	Higher ²	Organic Nutrient Export	7.13	Higher ²	Native Plant Diversity	8.53	Higher	Native Plant Diversity	8.59	Higher
	Value		1.70	Lower		N/A			N/A			1.79	Lower		10.00	Higher
Additional Attributes																
Carbon Sequestration	Function		4.12	Moderate ³		5.26	Moderate		5.56	Moderate		5.07	Moderate		4.14	Moderate ³
Public Use and Recognition	Value		1.76	Lower		1.82	Lower		1.82	Lower		1.76	Lower		3.75	Lower ³
Wetland Sensitivity			1.35	Lower		1.41	Lower		1.09	Lower		1.97	Moderate ³		5.94	Higher
Wetland Ecological Condition			3.48	Moderate ³		4.02	Moderate		2.32	Lower ³		5.56	Higher ²		4.02	Moderate
Wetland Stressors			3.33	Lower ³		3.33	Lower ³		5.00	Moderate		5.00	Moderate		3.33	Lower ³

Notes:
1. Groups are a "roll-up" of individual functions and their associated values organized into thematic categories. For any assessed wetland, the specific function selected to represent a function group is that with the highest-rated function and the highest-rated associated value from among the group's members.
2. Rating has a Rating Break Proximity of "MH", which indicates that the rating score is within the statistical confidence interval of the break between Moderate and Higher ratings.
3. Rating has a Rating Break Proximity of "LM", which indicates that the rating score is within the statistical confidence interval of the break between Lower and Moderate ratings.

Table 6
Post-Project Wetland Functions and Values Assessment Results

Groups ¹		Assessment Area and HGM Wetland Classification														
		Assessment Area 6 Wetland U (Depressional)			Assessment Area 7 Wetland Z (Depressional)			Assessment Area 8 Wetland DD (Depressional)			Assessment Area 9 Wetlands EE and FF (Depressional)			Assessment Area 10 Wetland OO (Depressional Outflow)		
		Highest Rated Function	Score	Rating	Highest Rated Function	Score	Rating	Highest Rated Function	Score	Rating	Highest Rated Function	Score	Rating	Highest Rated Function	Score	Rating
Hydrologic Function	Function	Water Storage and Delay	4.14	Moderate ³	Water Storage and Delay	10.00	Higher	Water Storage and Delay	10.00	Higher	Water Storage and Delay	10.00	Higher	Water Storage and Delay	4.35	Moderate ³
	Value		7.50	Higher		7.50	Higher		7.50	Higher		7.50	Higher		7.50	Higher
Water Quality Support	Function	Sediment Retention and Stabilization	2.88	Lower	Sediment Retention and Stabilization	10.00	Higher	Sediment Retention and Stabilization	10.00	Higher	Sediment Retention and Stabilization	10.00	Higher	Sediment Retention and Stabilization	3.12	Lower ³
	Value		7.17	Higher		6.96	Higher		7.05	Higher		6.86	Higher		7.05	Higher
Fish Habitat	Function	Anadromous Fish Habitat	0.00	Lower	Anadromous Fish Habitat	0.00	Lower	Anadromous Fish Habitat	0.00	Lower	Anadromous Fish Habitat	0.00	Lower	Anadromous Fish Habitat	0.00	Lower
	Value		0.00	Lower		0.00	Lower		0.00	Lower		0.00	Lower		0.00	Lower
Aquatic Habitat	Function	Amphibian and Reptile Habitat	7.85	Higher	Waterbird Nesting Habitat	7.45	Higher ²	Waterbird Nesting Habitat	7.85	Higher	Waterbird Nesting Habitat	7.96	Higher	Waterbird Nesting Habitat	7.90	Higher
	Value		1.11	Lower		1.72	Moderate ³		1.72	Moderate ³		1.72	Moderate ³		1.72	Moderate ³
Ecosystem Support	Function	Organic Nutrient Export	7.19	Higher ²	Native Plant Diversity	6.66	Higher ²	Aquatic Invertebrate Habitat	7.50	Higher ²	Water Cooling	9.83	Higher	Organic Nutrient Export	6.08	Moderate
	Value		N/A			1.48	Lower		1.08	Lower		0.00	Lower		N/A	
Carbon Sequestration	Function		2.75	Lower		5.59	Moderate		4.71	Moderate		4.98	Moderate		2.87	Lower
Public Use and Recognition	Value		1.88	Lower		1.88	Lower		1.88	Lower		1.88	Lower		1.88	Lower
Wetland Sensitivity			4.47	Higher ²		2.15	Lower ³		2.04	Lower ³		2.27	Moderate ³		4.33	Moderate ²
Wetland Ecological Condition			0.72	Lower		2.99	Moderate ³		3.04	Moderate ³		1.46	Lower		1.51	Lower
Wetland Stressors			3.33	Lower ³		5.00	Moderate		5.00	Moderate		5.00	Moderate		3.33	Lower ³

Notes:
1. Groups are a "roll-up" of individual functions and their associated values organized into thematic categories. For any assessed wetland, the specific function selected to represent a function group is that with the highest-rated function and the highest-rated associated value from among the group's members.
2. Rating has a Rating Break Proximity of "MH", which indicates that the rating score is within the statistical confidence interval of the break between Moderate and Higher ratings.
3. Rating has a Rating Break Proximity of "LM", which indicates that the rating score is within the statistical confidence interval of the break between Lower and Moderate ratings.

Table 6
Post-Project Wetland Functions and Values Assessment Results

Groups ¹		Assessment Area and HGM Wetland Classification														
		Assessment Area 11 Wetland PP (Depressional Outflow)			Assessment Area 12 Created Wetland M-1 (Slope/Depressional Outflow)			Assessment Area 13 Created Wetland M-2 (Depressional)			Assessment Area 14 Created Wetland M-3 (Slope/Depressional)			Assessment Area 15 Created Wetlands M-4 through M-10 (Depressional)		
		Highest Rated Function	Score	Rating	Highest Rated Function	Score	Rating	Highest Rated Function	Score	Rating	Highest Rated Function	Score	Rating	Highest Rated Function	Score	Rating
Hydrologic Function	Function	Water Storage and Delay	4.29	Moderate ³	Water Storage and Delay	5.47	Moderate	Water Storage and Delay	10.00	Higher	Water Storage and Delay	4.81	Moderate	Water Storage and Delay	10.00	Higher
	Value		7.50	Higher		7.50	Higher		7.50	Higher		7.50	Higher		7.50	Higher
Water Quality Support	Function	Sediment Retention and Stabilization	3.06	Lower ³	Sediment Retention and Stabilization	4.88	Moderate	Sediment Retention and Stabilization	10.00	Higher	Sediment Retention and Stabilization	5.09	Moderate	Sediment Retention and Stabilization	10.00	Higher
	Value		7.80	Higher		7.52	Higher		7.17	Higher		7.32	Higher		7.42	Higher
Fish Habitat	Function	Anadromous Fish Habitat	0.00	Lower	Anadromous Fish Habitat	0.00	Lower	Anadromous Fish Habitat	0.00	Lower	Anadromous Fish Habitat	0.00	Lower	Anadromous Fish Habitat	0.00	Lower
	Value		0.00	Lower		0.00	Lower		0.00	Lower		0.00	Lower		0.00	Lower
Aquatic Habitat	Function	Amphibian and Reptile Habitat	7.87	Higher	Waterbird Nesting Habitat	8.24	Higher	Waterbird Feeding Habitat	9.24	Higher	Waterbird Nesting Habitat	8.29	Higher	Waterbird Nesting Habitat	7.74	Higher
	Value		1.11	Lower		1.72	Moderate ³		3.75	Moderate		1.72	Moderate ³		1.72	Moderate ³
Ecosystem Support	Function	Organic Nutrient Export	7.47	Higher	Native Plant Diversity	8.85	Higher	Native Plant Diversity	7.39	Higher ²	Water Cooling	6.68	Higher	Native Plant Diversity	7.48	Higher ²
	Value		N/A			10.00	Higher		1.89	Lower		0.00	Lower		10.00	Higher
Carbon Sequestration	Function		2.75	Lower		4.92	Moderate		6.32	Higher ²		6.22	Higher ²		3.80	Lower
Public Use and Recognition	Value		1.88	Lower		3.76	Lower ³		3.92	Lower ³		3.74	Lower ³		3.82	Lower ³
Wetland Sensitivity			4.43	Moderate ²		6.30	Higher		2.64	Moderate ³		1.68	Lower ³		5.56	Higher
Wetland Ecological Condition			0.72	Lower		5.06	Moderate ²		5.47	Higher ²		4.40	Moderate		2.99	Moderate ³
Wetland Stressors			3.33	Lower ³		3.33	Lower ³		5.00	Moderate		5.00	Moderate		5.00	Moderate

Notes:
1. Groups are a "roll-up" of individual functions and their associated values organized into thematic categories. For any assessed wetland, the specific function selected to represent a function group is that with the highest-rated function and the highest-rated associated value from among the group's members.
2. Rating has a Rating Break Proximity of "MH", which indicates that the rating score is within the statistical confidence interval of the break between Moderate and Higher ratings.
3. Rating has a Rating Break Proximity of "LM", which indicates that the rating score is within the statistical confidence interval of the break between Lower and Moderate ratings.

4 Stream Classification

All delineated streams on the project site were classified according to the Cowardin classification system (Cowardin et al. 1979). Streams are also classified based on the frequency and duration of flow within their channels, which were determined using the *Streamflow Duration Assessment Method for the Pacific Northwest* (Nadeau 2015). Table 7 summarizes the Cowardin classifications for each stream on the project site, including their off-site portions.

Table 7
Stream Classifications

Non-Wetland Other Waters	Cowardin Classification System ¹	Total Area	
		Square Feet	Acres
Ephemeral Stream B	N/A	215	0.005
Ephemeral Stream C	N/A	47	0.001
Ephemeral Stream D	N/A	61	0.001
Intermittent Stream B	R4RB1	1,970	0.045
Tributary to Intermittent Stream B	R4RB1	511	0.012
Intermittent Stream C	R4RB1	104	0.002
Intermittent Stream D	R4RB1	61	0.001
Perennial Stream 1-A	R2UBH	407	0.009
Total Ephemeral Stream Area		323	0.007
Total Intermittent Stream Area		2,646	0.060
Total Perennial Stream Area		407	0.009
Total Stream Area		3,376	0.076

Notes:

- Cowardin classification system (Cowardin et al. 1979) wetland codes:
 R2UBH: riverine, lower perennial, unconsolidated bottom, permanently flooded
 R4RB1: riverine, intermittent, rock bottom, bedrock
 NA: Not applicable

5 Stream Functions and Values Assessment

5.1 Stream Assessment Areas

The assessment areas for the pre-project stream functions and values assessment include Intermittent Stream B, Tributary to Intermittent Stream B, Intermittent Stream D, and Perennial Stream 1-A (Figures 4c and 4d). Only the intermittent streams whose flow would be impacted by the proposed quarry or remaining on the project site were assessed. Although not proposed to be impacted and located upslope from mitigation activities, Perennial Stream 1-A was also assessed to determine its existing functions and values for comparison to the created stream channel (Perennial Stream MS-1). Ephemeral Stream B may be affected by the project; however, a functions and values assessment was not completed because ephemeral streams are exempt per Oregon Administrative Rule 141-085-0515(3). An assessment was also not completed for Ephemeral Stream 1-A because it is not proposed to be impacted and is upslope from mitigation activities. All other streams identified during the 2019 delineation (PHS 2020a, 2020b) and the 2021 Anchor QEA delineation (2021) are outside the project site and would be avoided by the project. Because Intermittent Stream C is contained entirely within the boundaries of Wetland QQ, it was not assessed under the SFAM method and instead was assessed under the ORWAP method as part of Wetland QQ. Additionally, because Ephemeral Stream C and Ephemeral Stream D are both partially contained within Wetland U and Wetland PP, respectively, they were not assessed using the SFAM method and instead were assessed under the ORWAP method. Table 8 summarizes the streams included in the stream assessment areas under pre-project conditions.

Table 8
Stream Assessment Areas Included in the Pre-Project Functions and Values Assessment

Stream Assessment Area	Streams Included in Assessment Area	Cowardin Classification System ¹	Total Area	
			Square Feet	Acres
1	Intermittent Stream B	R4RB1	1,970	0.045
2	Tributary to Intermittent Stream B	R4RB1	511	0.012
3	Intermittent Stream D	R4RB1	61	0.001
4	Perennial Stream 1-A	R2UBH	407	0.009

Note:

1. Cowardin classification system (Cowardin et al. 1979) wetland codes:
R2UBH: riverine, lower perennial, unconsolidated bottom, permanently flooded
R4RB1: riverine, intermittent, rock bottom, bedrock

5.2 Assessment Methods

As mentioned in Section 1.1, SFAM (Nadeau et al. 2018a) was used to assess the functions and values of the existing streams on the project site. As shown in Table 9, the SFAM divides stream functions into four categories—hydrologic, geomorphic, biologic, and water quality functions—with a suite of 11 specific stream functions included under these categories (Nadeau et al. 2018a). Each stream function is assigned one or more of 17 stream measures of function and 16 stream measures of value, which are metrics that allow a quantitative or qualitative assessment of specific attributes that may indicate the extent to which a particular function is active (Nadeau et al. 2018b). Streams are intended to be assessed by evaluating the degree to which they perform or provide these metrics.

Table 9
Functions and Values Assessed by the Oregon Stream Function Assessment Method

Functional Group	Specific Functions	Definition and Services and Values Provided	Stream Measures of Function
Hydrologic Functions	Surface Water Storage	Temporary storage of surface water in relatively static state, generally during high flow, as in floodplain inundation, backwater channels, and wetland depressions. Providing regulating discharge, replenishes soil moisture, provides pathways for fish and invertebrate movement, low velocity habitat and refuge, and contact time for biogeochemical processes.	<ul style="list-style-type: none"> • Overbank Flow • Incision • Floodplain Exclusion • Channel Bed Variability • Wood • Side Channels
	Sub/Surface Transfer	Transfer of water between surface and subsurface environments, often through the hyporheic zone. Provides aquifer recharge, base-flow, exchange of nutrients and chemicals through the hyporheic zone, moderates flow, and maintains soil moisture.	<ul style="list-style-type: none"> • Overbank Flow • Wetland Vegetation • Side Channels • Channel Bed Variability
	Flow Variation ¹	Daily, seasonal, and inter-annual variation in flow. Provides variability in stream energy driving channel dynamics, provides environmental cues for life history transitions, redistributes sediment, provides habitat variability (temporal), and provides sorting of sediment and differential deposition.	<ul style="list-style-type: none"> • Channel Bed Variability • Embeddedness
Geomorphic Functions	Sediment Continuity	The balance between transport and deposition of sediment such that there is no net erosion or deposition (aggradation or degradation) within the channel. Maintains channel character and associated habitat diversity, provides sediment source and storage for riparian and aquatic habitat succession, and maintains channel equilibrium.	<ul style="list-style-type: none"> • Incision • Bank Erosion • Lateral Migration
	Substrate Mobility	Regular movement of channel bed substrate. Provides sorting of sediments, mobilizes and flushes fine sediment, creates and maintains hydraulic diversity, and creates and maintains habitat.	<ul style="list-style-type: none"> • Bank Armoring • Embeddedness • Channel Bed Variability
Biologic Functions	Maintain Biodiversity	Maintain the variety of species, life forms of a species, community compositions, and genetics. Biodiversity provides species and community resilience in the face of disturbance and disease, full spectrum trophic resources, and balance of resource use (through interspecies competition).	<ul style="list-style-type: none"> • Fish Passage Barriers • Channel Bed Variability • Wood • Side Channels • Invasive Vegetation • Native Woody Vegetation • Large Trees • Wetland Vegetation

Functional Group	Specific Functions	Definition and Services and Values Provided	Stream Measures of Function
	Create Habitat (Aquatic/Riparian)	Create and maintain the suite of physical, chemical, thermal, and nutritional resources necessary to sustain organisms. Habitat sustains native organisms. Habitat includes in-channel habitat, as defined largely by depth, velocity, and substrate, and riparian habitat, as defined largely by vegetative structure.	<ul style="list-style-type: none"> • Floodplain Exclusion • Wood • Embeddedness • Channel Bed Variability • Native Woody Vegetation • Large Trees • Incision • Side Channels • Fish Passage Barriers
	Sustain Trophic Structure	Production of food resources necessary to sustain all trophic levels including primary producers, consumers, prey species, and predators. Trophic structure provides basic nutritional resources for aquatic resources and regulates the diversity of species and communities.	<ul style="list-style-type: none"> • Overbank Flow • Natural Cover • Invasive Vegetation • Native Woody Vegetation • Wetland Vegetation
Chemical and Nutrient Functions	Nutrient Cycling	Transfer and storage of nutrients from environment to organisms and back to environment. Provides basic resources for primary production, regulates excess nutrients, and provides sink and source for nutrients.	<ul style="list-style-type: none"> • Overbank Flow • Channel Bed Variability • Vegetated Riparian Corridor Width • Wetland Vegetation • Natural Cover
	Chemical Regulation	Moderation of chemicals in the water. Limits the concentration of beneficial and detrimental chemicals in the water.	<ul style="list-style-type: none"> • Vegetated Riparian Corridor Width • Channel Bed Variability • Wetland Vegetation • Overbank Flow
	Thermal Regulation	Moderation of water temperature. Limits the transfer and storage of thermal energy to and from streamflow and hyporheic zone.	<ul style="list-style-type: none"> • Natural Cover

Notes:

Table adapted from Table 2.1 Stream Function Categorization, Definition, and Ecosystem Services Provided from Nadeau et al. (2018a) and from Table 4.2 Measure Informing Each Function Formula from Nadeau et al. (2018b).

1. Flow variation is also informed by the value measure Impoundments.

5.3 Pre-Project SFAM Functions and Values Assessment Results

The results of the SFAM functions and values assessments for the four stream assessment areas under pre-project (i.e., existing) conditions are summarized in Table 10. Copies of the pre-project SFAM functions and values assessment data forms are provided in Appendix D, and copies of the Oregon Explorer SFAM Reports and USGS StreamStats Reports are provided in Appendix E.

Table 10
Pre-Project Stream Functions and Values Assessment Results

Groups ¹		Pre-Project Stream Function Assessment Area											
		Intermittent Stream B			Tributary to Intermittent Stream B			Intermittent Stream D			Perennial Stream 1-A		
		Highest Rated Function	Score	Rating	Highest Rated Function	Score	Rating	Highest Rated Function	Score	Rating	Highest Rated Function	Score	Rating
Hydrologic Function	Function	Flow Variation	8.75	Higher	Flow Variation	7.21	Higher	Flow Variation	6.67	Moderate	Flow Variation	8.34	Higher
	Value		8.33	Higher		8.33	Higher		9.50	Higher		8.33	Higher
Geomorphic Function	Function	Sediment Mobility	8.50	Higher	Sediment Continuity	8.55	Higher	Sediment Continuity	10.00	Higher	Sediment Mobility	8.39	Higher
	Value		5.00	Moderate		3.25	Moderate		3.48	Moderate		6.25	Moderate
Biologic Function	Function	Sustain Trophic Structure	7.06	Higher	Sustain Trophic Structure	5.77	Moderate	Sustain Trophic Structure	5.44	Moderate	Sustain Trophic Structure	6.08	Moderate
	Value		5.11	Moderate		5.11	Moderate		4.61	Moderate		6.36	Moderate
Water Quality Function	Function	Chemical Regulation	7.58	Higher	Chemical Regulation	6.42	Moderate	Thermal Regulation	5.10	Moderate	Chemical Regulation	8.24	Higher
	Value		2.50	Lower		2.50	Lower		7.40	Higher		2.50	Lower

Note:

1. Groups are a "roll-up" of individual functions and their associated values organized into thematic categories. For any assessed stream, the specific function selected to represent a function group is that with the highest-rated function and the highest-rated associated value from among the group's members.

As shown in Table 10, Perennial Stream 1-A was found to be performing at higher levels for the hydrologic, geomorphic, and water quality functional groups and more moderately for the biologic functional group. The contributing factors for many of these attributes include seasonal variation in flow, variability in channel bed, presence of adjacent wetland vegetation, and limitations in concentrations of chemicals in the water. Factors limiting the biologic functional group include the presence of invasive vegetation and the presence of a culvert at the upstream end of the stream channel. The value scores were more variable for Perennial Stream 1-A, with a higher value score for the hydrologic functional group, more moderate value scores for the geomorphic and biologic functional groups, and a lower value score for the water quality functional group. Factors limiting the value of the water quality function include less opportunity to filter waterborne pollutants from the surrounding basin due to limited presence of upstream pollutants sources, and lack of connection to a known drinking water source or habitat known to be important to fish, wildlife, or plant species.

Intermittent Stream B was found to be performing all function attributes at high levels under current conditions (Table 10). The contributing factors for many of these attributes include seasonal variation in flow, lack of channel erosion, presence of nutritional resources to support food chains, and limitations in concentrations of chemicals in the water. The value scores were more variable for Intermittent Stream B, with a higher value score for the hydrologic functional group, more moderate value scores for the geomorphic and biologic functional groups, and a lower value score for the water quality functional group. Factors limiting the value of the water quality function include less opportunity to filter waterborne pollutants from surrounding basin due to limited presence of upstream pollution sources and lack of connection to a known drinking water source or habitat known to be important to fish, wildlife, or plant species.

Tributary to Intermittent Stream B was found to be performing at higher levels for the hydrologic and geomorphic functional groups and more moderately for the biologic and water quality functional groups (Table 10). Factors limiting the stream's ability to provide higher biologic and water quality functions include the lack of adjacent woody vegetation and overhanging cover and limited channel bed variability. The value scores for these functions ranged from higher to lower, with a higher value score for the hydrologic functional group, a moderate value score for the biologic functional group, and lower scores for the geomorphic and water quality functional groups. Factors limiting the values of the geomorphic and water quality functions include lack of erodible substrate, less opportunity to filter waterborne pollutants from the surrounding basin due to limited presence of upstream pollution sources, and lack of connection to a known drinking water source or habitat known to be important to fish, wildlife, or plant species.

Intermittent Stream D was found to be performing at higher levels for the geomorphic and water quality functional groups and more moderately for the hydrologic and biologic functional groups (Table 10). Factors limiting the stream's ability to provide higher hydrologic and biologic functions

include being located on a steep slope, lack of woody debris in the channel, and a lack of large trees in the riparian zone. The value scores for these functions ranged from higher to moderate, with higher value scores for the hydrologic and water quality functional groups and more moderate value scores for the geomorphic and biologic functional groups. Factors limiting the values of the geomorphic and biologic functions include lack of erodible substrate and limited in-channel habitat.

5.4 Post-Project Functions and Values Assessment Results

Under post-project conditions (i.e., the expected future conditions of the project site [Section 1.2.2]), all streams within the proposed mining site would cease to exist, including any off-site portions, and therefore, would no longer perform any stream functions or provide values for those functions. Although Intermittent Stream B and Tributary to Intermittent Stream B would not be directly impacted by the proposed mining site, they would not receive the same hydrology as under existing conditions and would, therefore, be assumed to no longer exist as assessed. Created Perennial Stream MS-1 would reconnect to Intermittent Stream B and provide perennial flow to the existing Intermittent Stream B outlet. However, due to the change in hydrology from intermittent to perennial, Perennial Stream MS-1 was assessed as an entire new stream. Under post-project conditions, the CMP would also be fully implemented and functioning as designed, including the creation of Perennial Stream MS-1 (Figures 5a through 5d). Table 11 provides a summary of the stream assessment area under post-project conditions.

The following assumptions were used in the post-project conditions functions and values assessment:

- The CMP is functioning as designed and is in place for a minimum of 5 years.
- Existing soils and underlying basalt are graded to create conditions that result in water flowing in the created channel year-round from water received from existing Perennial Stream 1-A and from the created Perennial Stream MS-1 channel graded to be in direct contact with the water table.
- Select excavated areas have been backfilled with clay or similar materials that have prevented captured water from infiltrating fissures in the bedrock.
- Hydrology from Perennial Stream 1-A is captured by the created Perennial Stream MS-1 and associated created fringe Slope/Depressional Outflow PFO/PSS/PEM wetland complex (Wetland M-1) and routed into some of the remaining portions of Wetland M and the Intermittent Stream B channel similar to existing conditions.
- Native upland from the impact area has established sufficient upland soil to support woody species in riparian areas.
- Native trees and shrubs are established along the length of the created Perennial Stream MS-1 channel to provide sufficient over-water shade cover.

- Microtopography has been created in the Perennial Stream MS-1 channel that increases bed variability.
- Logs and root balls salvaged from the impact site have been placed into portions of Perennial Stream MS-1 and are enhancing water quality habitat functions.
- At least 25 pieces of unanchored wood (each a minimum of 4 inches in diameter and 5 feet long) have been placed in and across the created stream channel in various locations resulting in habitat-forming processes, including large log jams that span a quarter or more of the channel width.
- Side channels that make up at least 20% of the length of the created channel have been established along the created stream.
- Invasive species have been actively managed during regular mitigation area maintenance by using hand pulling, flaming, shading, and spot-spraying methods.

Table 11
Stream Assessment Areas Included in the Post-Project Functions and Values Assessment

Stream Assessment Area	Streams Included in Assessment Area	Cowardin Classification System ¹	Total Length	Total Area	
				Square Feet	Acres
1	Created Perennial Stream MS-1	R2UBH	5,222	54,930	1.30

Notes:

1. Cowardin classification system (Cowardin et al. 1979) wetland codes:
R2UBH: riverine, lower perennial, unconsolidated bottom, permanently flooded
R4RB1: riverine, intermittent, rock bottom, bedrock
2. Oregon HGM classification system (Adamus 2001)

The results of the SFAM functions and values assessments for the newly created Perennial Stream MS-1 under post-project conditions are summarized in Table 12. Copies of the post-project SFAM functions and values assessment data forms are provided in Appendix F, and copies of the Oregon Explorer SFAM Report and USGS StreamStats Report are provided in Appendix G.

Under post-project conditions, Perennial Stream MS-1 is predicted to perform at similar levels or better compared to pre-project conditions for all functional groups of Intermittent Stream B, Tributary to Intermittent Stream B, Intermittent Stream D, and Perennial Stream 1-A. The created stream would provide hydrology for created Wetland M-1, traveling approximately 5,222 feet to its connection with the remaining portions of Wetland M and Intermittent Stream B in the southeastern area of the project site. The streambank and streambed would consist of a mix of exposed bedrock, gravel, and fines, similar to the conditions of the impacted streams (Intermittent Stream B, Tributary to Intermittent Stream B, Intermittent Stream D, and Perennial Stream 1-A), and would meander to reduce velocities, erosion, and sedimentation. It would route water around the quarry and tie into the

Existing Intermittent Stream B, providing longer flow periods and maintaining the off-site hydrology contribution.

Table 12
Post-Project Stream Functions and Values Assessment Results

Groups ¹		Post-Project Stream Function Assessment Area		
		Perennial Stream MS-1		
		Highest-Rated Function	Score	Rating
Hydrologic Function	Function	Sub/Surface Water Transfer	7.73	Higher
	Value		5.83	Moderate
Geomorphic Function	Function	Sediment Continuity	9.85	Higher
	Value		3.25	Moderate
Biologic Function	Function	Sustain Trophic Structure	7.96	Higher
	Value		6.32	Moderate
Water Quality Function	Function	Chemical Regulation	8.80	Higher
	Value		2.50	Lower

Notes:

1. Groups are a “roll-up” of individual functions and their associated values organized into thematic categories. For any assessed stream, the specific function selected to represent a function group is the one with the highest-rated function and the highest-rated associated value from among the group’s members.

6 Summary

Wetland functions and values were assessed for all the delineated wetlands on the project site using ORWAP. Under pre-project (i.e., existing) conditions, 21 wetland assessment areas were established and assessed for functions and values (Section 3.3). Under post-project conditions, existing wetlands, wetlands that would be enhanced, the remaining portion of Wetland M, and wetlands that would be created as part of the CMP were assessed for functions and values (Section 3.4).

Under pre-project conditions, all wetland assessment areas are performing at high to moderate levels for most functional groups except for Assessment Area 1 (Wetland A), which received a lower score for the water quality support function, Assessment Area 7 (Wetland M), which received a lower score for the water storage and delay function, Assessment Area 9 (Wetlands L, SS, and XX), which received lower scores for the water storage and delay and water quality support functions, and Assessment Area 11 (Wetland U), Assessment Area 18 (Wetland PP), Assessment Area 19 (Wetland YY), and Assessment Area 21 (Wetland OO), which received lower scores for the sediment retention and stabilization function. Wetland value scores were higher for all wetland assessment areas for the water storage and delay and water quality support functional groups. For the aquatic habitat and ecosystem support functional groups, all wetland assessment areas received lower to moderate value scores except for Assessment Area 7 (Wetland M), Assessment Area 10 (Wetlands O through T, QQ and RR), and Assessment Area 19 (Wetland PP), which received higher value scores for ecosystem support. For the additional attributes, all wetlands received moderate to low value scores, except for Assessment Area 7 (Wetland M), Assessment Area 9 (Wetlands L, SS, and XX), and Assessment Area 10 (Wetlands O through T, QQ, and RR), which received higher value scores for the wetland sensitivity attribute due to containing the native wet prairie wetland type. Assessment Area 11 (Wetland U) and Assessment Area 19 (Wetland PP), which are also native wet prairie wetland types, both had a rating proximity break of "MH" for the Sensitivity attribute, indicating a close proximity break between the moderate and higher ratings. None of the assessment areas provide suitable fish habitat or are valued for that function based on all receiving lower function and value scores.

Under the post-project scenario, the existing wetlands, enhanced wetlands, the remaining portion of Wetland M, and the wetlands that would be created as part of the proposed CMP are predicted to perform at similar levels or better compared to pre-project conditions for all functional groups. The values of those functions are also anticipated to be higher for the enhanced and created wetlands once the CMP is complete and functioning as designed.

Stream functions and values were assessed for the three intermittent streams and one perennial stream on the project site using the SFAM method. Under pre-project conditions, the four stream assessment sites were assessed for stream functions and values (Section 5.3). Under post-project

conditions, the created Perennial Stream MS-1 assessment site was assessed for stream functions and values (Section 5.4).

Results for the stream functions and values assessment indicate that Perennial Stream 1-A was found to be performing at higher levels for the hydrologic, geomorphic, and water quality functional groups and more moderately for the biologic functional group. The value scores for those functions were more variable for Perennial Stream 1-A, with a higher value score for the hydrologic functional group, more moderate value scores for the geomorphic and biologic functional groups, and a lower value score for the water quality functional group. Intermittent Stream B is performing at a high level for all stream functional groups (hydrologic, geomorphic, biologic, and water quality). The value scores for those functions were higher for the hydrologic functional group, moderate for geomorphic and biologic functional groups, and lower for the water quality functional group. Tributary to Intermittent Stream B was found to be performing at higher levels for the hydrologic and geomorphic functional groups and more moderately for the biologic and water quality functional groups. The value scores for these functions ranged from higher to lower, with a higher value score for the hydrologic functional group, moderate value scores for the geomorphic and biologic functional groups, and a lower score for the water quality functional group. Intermittent Stream D was found to be performing at higher levels for the geomorphic functional group and more moderately for the hydrologic, biologic, and water quality functional groups. The value scores for these functions ranged from higher to moderate, with higher value scores for the hydrologic and water quality functional groups and more moderate value scores for the geomorphic and biologic functional groups.

Under the post-project scenario, Perennial Stream MS-1, the stream that would be created as part of the proposed CMP, is predicted to perform at similar levels or better compared to pre-project conditions for all functional groups for Intermittent Stream B, Tributary to Intermittent Stream B, Intermittent Stream D, and Perennial Stream 1-A. The values of those functions are also anticipated to be similar or higher for the created stream once the CMP is complete and functioning as designed.

7 References

- Adamus, P.R., 2001. *Guidebook for Hydrogeomorphic (HGM)-Based Assessment of Oregon Wetland and Riparian Sites: Statewide Classification and Profiles*. Oregon Division of State Lands. February 2001.
- Adamus, P., K. Verble, and M. Rudenko, 2016a. *Manual for the Oregon Rapid Wetland Assessment Protocol (ORWAP)*. Version 3.1. Oregon Department of State Lands. November 2016.
- Adamus, P., J. Morlan, K. Verble, and A. Buckley, 2016b. *Oregon Rapid Wetland Assessment Protocol*. ORWAP, revised. Version 3.1 Calculator Spreadsheet, Databases, and Data Forms. Oregon Department of State Lands, Salem, Oregon.
- Anchor QEA, LLC (Anchor QEA), 2021. Memorandum to Daniel Evans, PWS (Oregon Department of State Lands) from Anchor QEA entitled: *Watters Quarry Expansion Project Wetland Delineation Addendum (WD No. 2019 0623)*. March 24, 2021.
- Cowardin, L.M., V. Carter, F.C. Golet, and E.T. LaRoe, 1979. *Classification of Wetlands and Deepwater Habitats of the United States*. U.S. Department of the Interior – Fish and Wildlife Service. Washington, D.C.: Government Printing Office. December 1979.
- DSL (Oregon Department of State Lands), 2016. *Guidance for Using the Oregon Rapid Wetland Assessment Protocol (ORWAP) in State and Federal Permit Programs*. November 2016.
- McCune, M., M. Rempel, C. Trowbridge, T-L. Nadeau, D. Hicks, and J. Kagan, 2017. Oregon Explorer-Stream Function Assessment Method (SFAM) Map Viewer: An Internet Tool for SFAM Support. Oregon State University Library and Institute for Natural Resources, Oregon State University, Corvallis, Oregon. Available at: <https://oregonexplorer.info/content/stream-function-assessment-method-sfam-map-viewer-0?topic&ptopic>.
- Nadeau, Tracie-Lynn, 2015. *Streamflow Duration Assessment Method for the Pacific Northwest*. U.S. Environmental Protection Agency, Region 10, Seattle, Washington. EPA 910-K-14-001. November 2015.
- Nadeau, T-L., D. Hicks, C. Trowbridge, N. Maness, R. Coulombe, and N. Czarnomski, 2018a. *Stream Function Assessment Method for Oregon*. Version 1.0. U.S. Environmental Protection Agency, Region 10, Seattle, Washington. EPA 910-D-18-001. June 2018.
- Nadeau, T-L., C. Trowbridge, D. Hicks, and R. Coulombe, 2018b. *A Scientific Rationale in Support of the Stream Function Assessment Method for Oregon*. SFAM, Version 1.0. U.S. Environmental Protection Agency, Region 10, Seattle, Washington. EPA 910-S-18-001. June 2018.

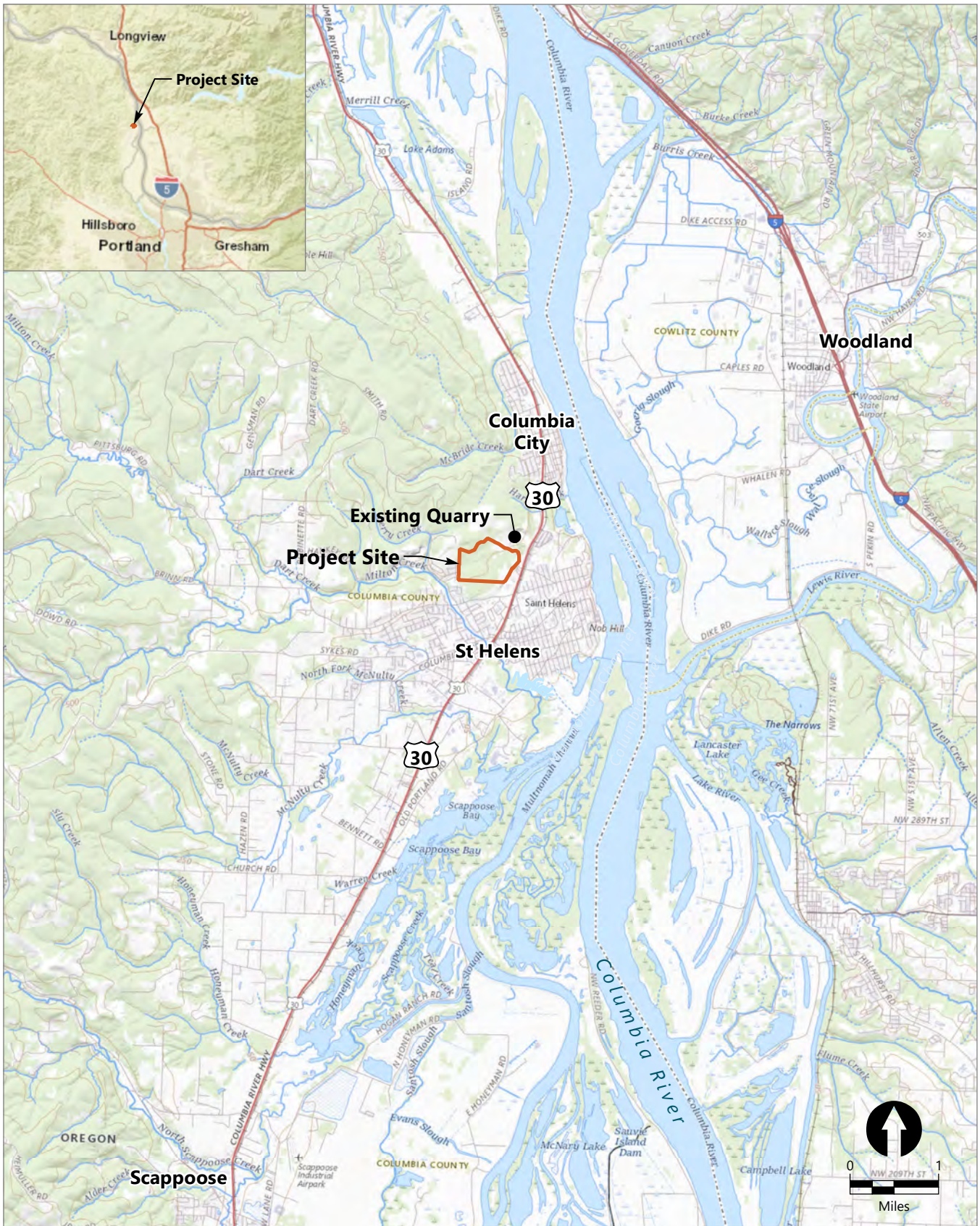
PHS (Pacific Habitat Services, Inc.), 2019. *Wetland Delineation for Watters Quarry, St. Helens, Oregon*. Prepared for Knife River Corporation – Northwest, Tangent, Oregon. November 11, 2019.

PHS, 2020a. Memorandum to: Daniel Evans, Oregon Department of State Lands. Regarding: Supplemental Information Regarding the Watters Quarry Wetland Delineation; WD 2019-0623. PHS #6300. July 17, 2020.

PHS, 2020b. Memorandum to: Daniel Evans, Oregon Department of State Lands. Regarding: Supplemental Information Regarding the Watters Quarry Wetland Delineation; WD 2019-0623. PHS #6300. August 5, 2020.

Rempel, M., P. Adamus, and J. Kagan, 2015. Oregon Explorer: Oregon Rapid Wetland Assessment Protocol (ORWAP) and Stream Function Assessment Method (SFAM) Map Viewer: An Internet Tool for ORWAP Wetland Assessment Support and Data Archiving. Oregon State University Library and Institute for Natural Resources, Oregon State University, Corvallis, Oregon. Accessed December 16, 2019. Available at: https://tools.oregonexplorer.info/OE_HTMLViewer/Index.html?viewer=orwap_sfam.

Figures



Publish Date: 2023/12/20, 11:57 AM | User: jfox
Filepath: \\orcas\GIS\Jobs\Knife_River_Corp_2114\Watters_Quarry\Maps\Functions_and_Values_Report\AQ_FVR_Fig1_Vicinity_Map.mxd






Figure 1
Vicinity Map

Wetland and Stream Functions and Values Assessment Report
Watters Quarry Phase II Project

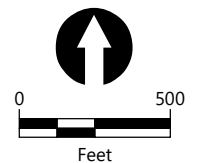


LEGEND:

-  Project Site
-  Proposed Mining Area
-  Tax Parcel

NOTES:

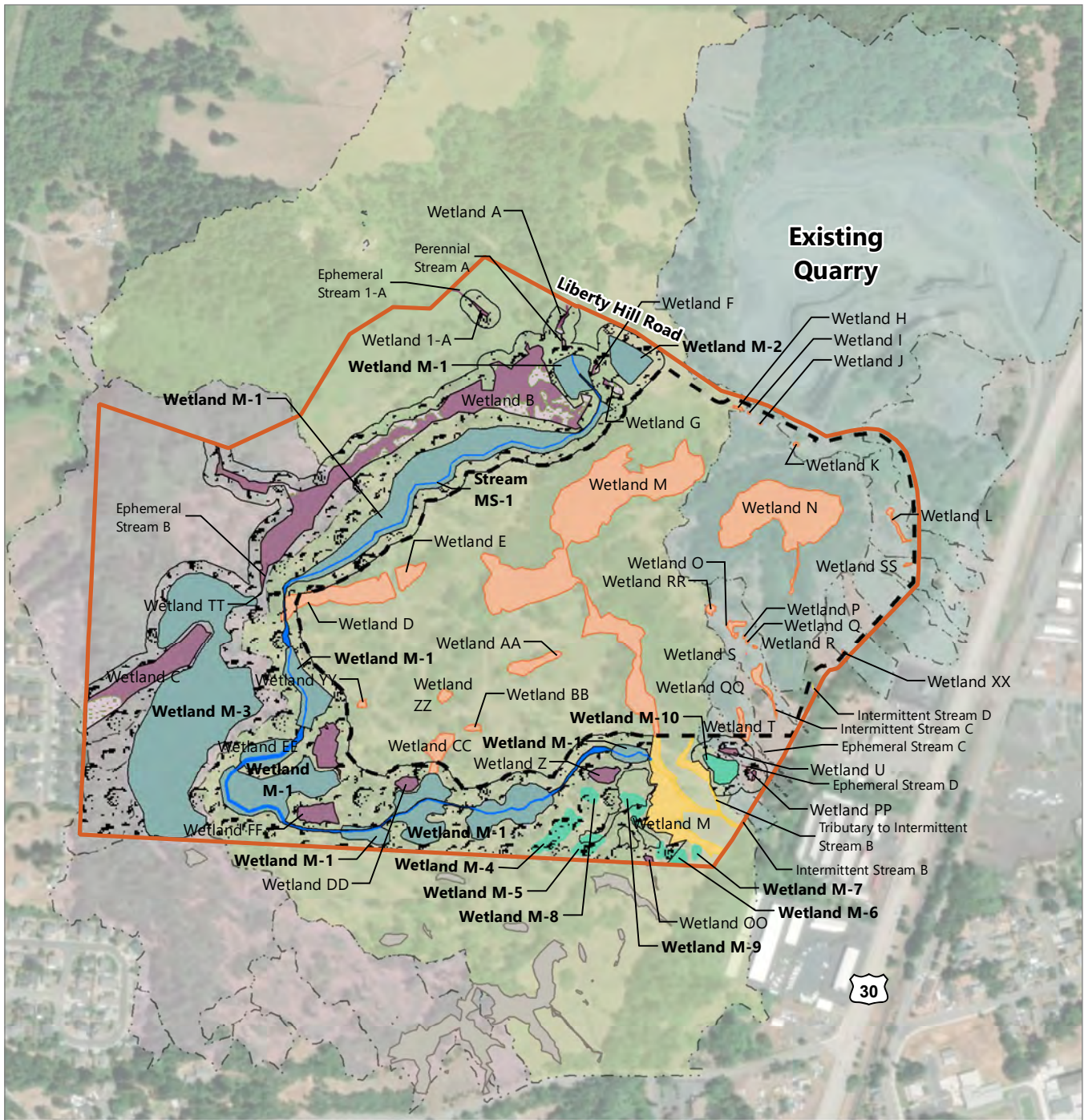
1. Aerial imagery: Esri (2021)
2. Tax lots sourced from Columbia County.



Publish Date: 2023/12/20, 11:59 AM | User: jfox
Filepath: \\orcas\GIS\Jobs\Knife_River_Corp_2114\Watters_Quarry\Maps\Functions_and_Values_Report\AQ_FVR_Fig2_Tax_Lot_Map.mxd



Figure 2
Tax Lot Map

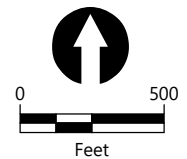


LEGEND:

Project Site	Direct Impact	Perennial Stream
Proposed Mining Area	Indirect Impact	ARSC Wetland
Drainage Basin	No Impact	Wetland
Eastern Basin	No Impact (Off Site)	Enhancement Area
Central Basin		Wetland and Stream Buffer
Western Basin		

NOTE:

1. Aerial imagery: Esri (2021)

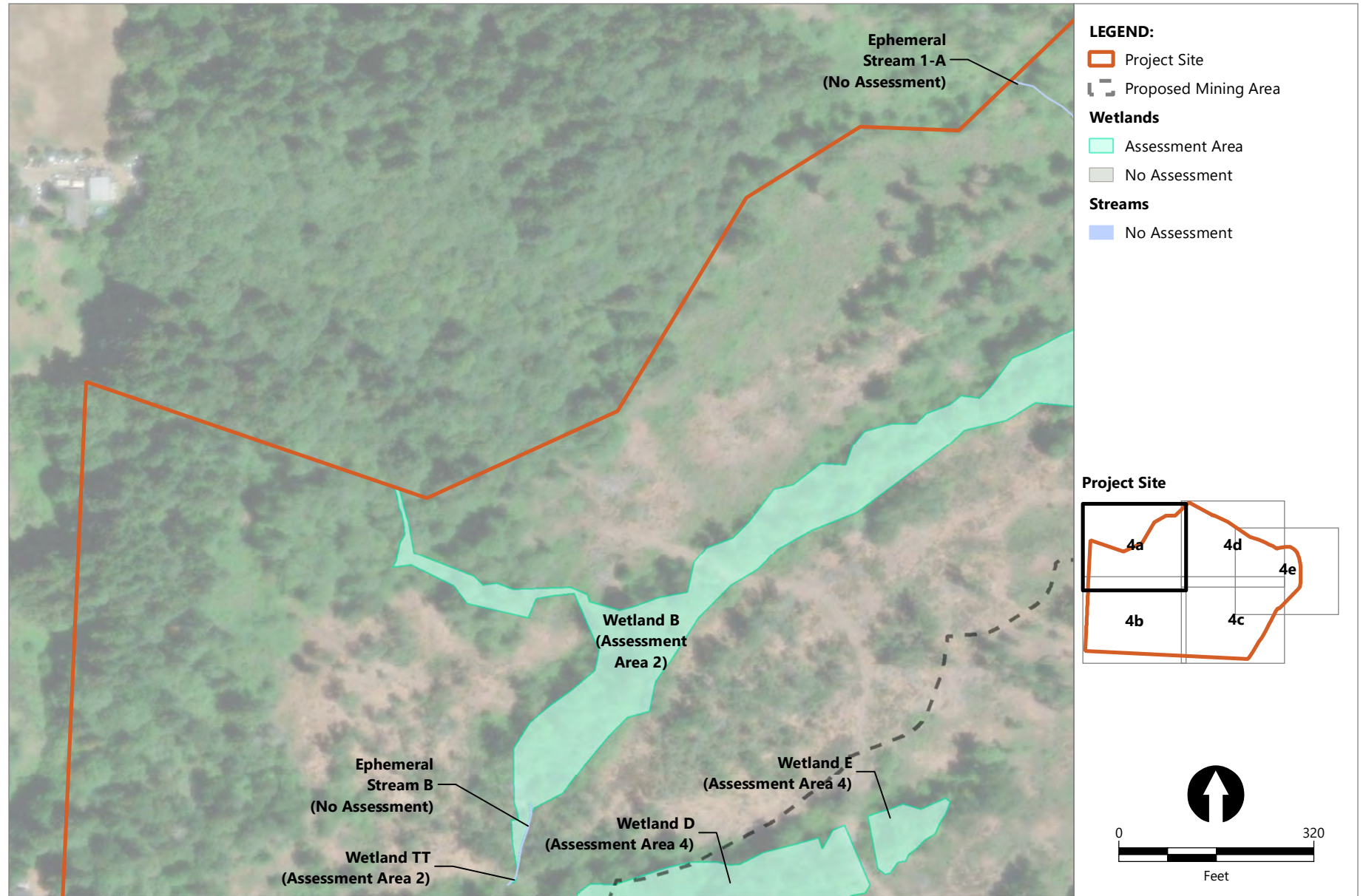


Publish Date: 2023/12/20, 12:01 PM | User: jfox

Filepath: \\orcas\GIS\Jobs\Knife_River_Corp_2114\Watters_Quarry\Maps\Functions_and_Values_Report\AQ_FVR_Fig3_Proposed_Project_Overview_Map.mxd



Figure 3
Compensatory Mitigation Overview Map
 Wetland and Stream Functions and Values Assessment Report
 Watters Quarry Phase II Project

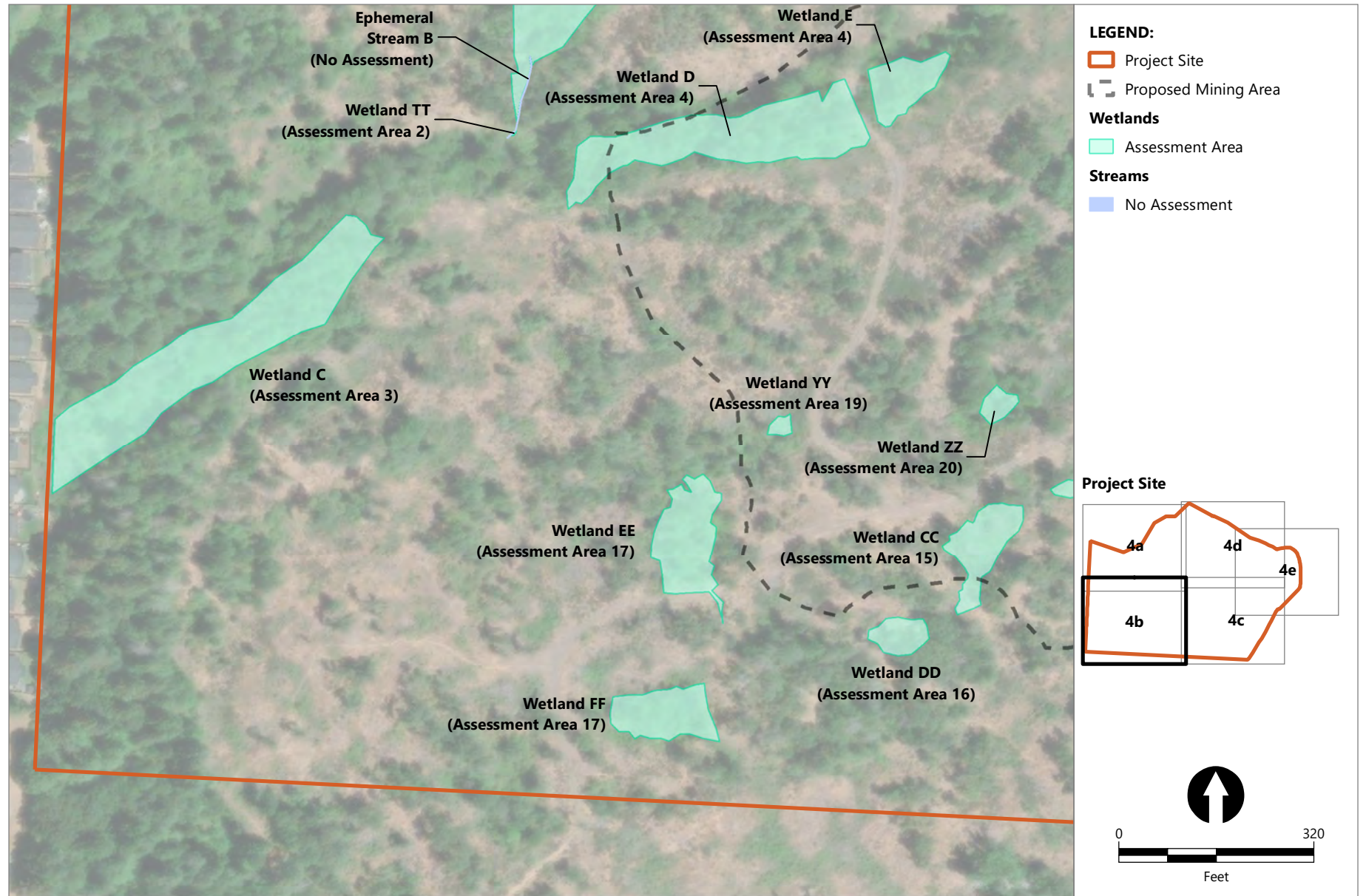


Publish Date: 2023/12/20, 2:42 PM | User: jfox
Filepath: \\orcas\GIS\Jobs\Knife_River_Corp_2114\Watters_Quarry\Maps\Functions_and_Values_Report\AQ_FVR_Fig4_PreProject_Wetland_Assessment_Areas_Map.mxd



Figure 4a
Pre-Project Functions and Values Wetland and Stream Assessment Areas

Wetland and Stream Functions and Values Assessment Report
Watters Quarry Phase II Project

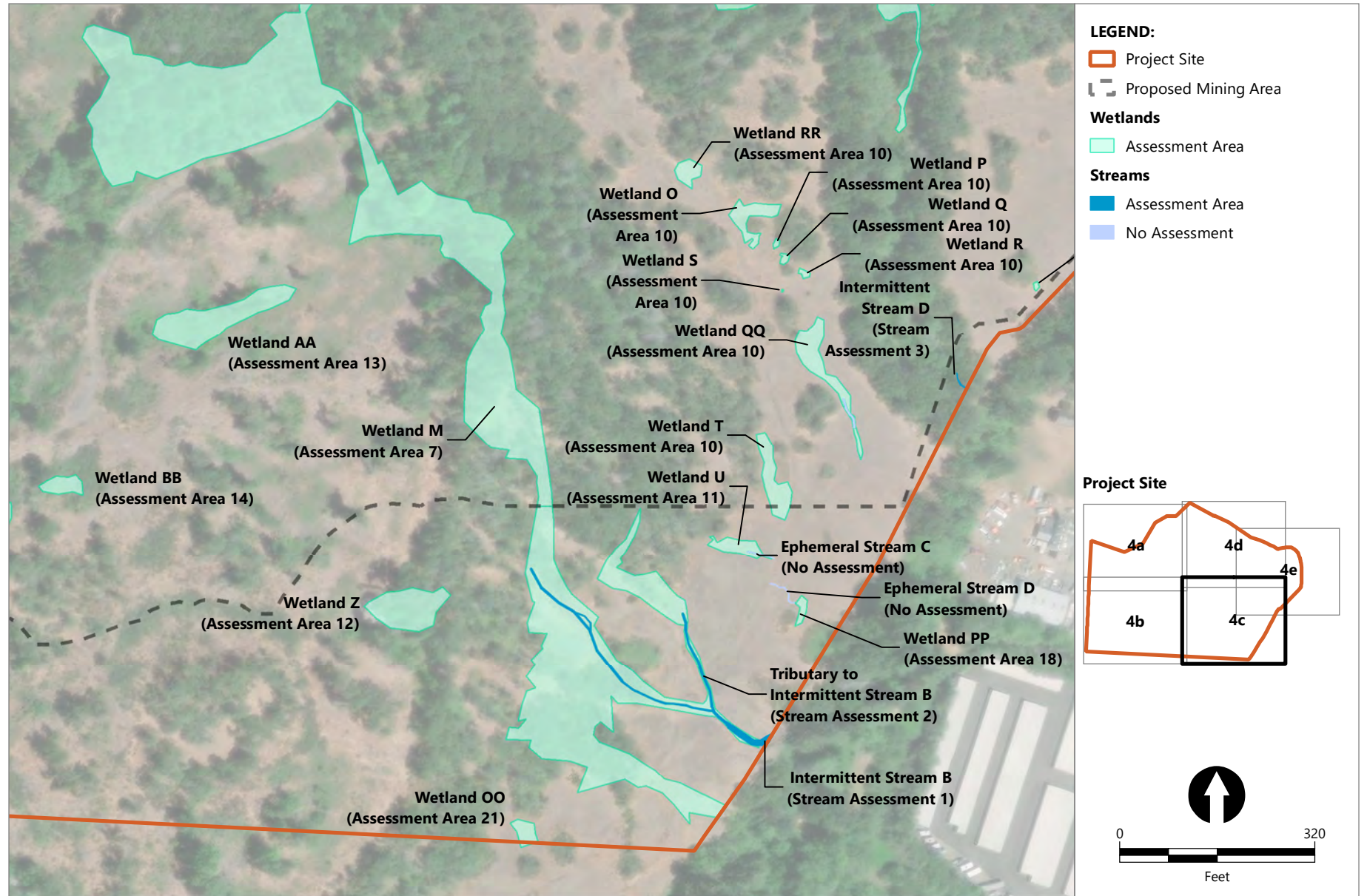


Publish Date: 2023/12/20, 2:43 PM | User: jfox
Filepath: \\orcas\GIS\Jobs\Knife_River_Corp_2114\Watters_Quarry\Maps\Functions_and_Values_Report\AQ_FVR_Fig4_PreProject_Wetland_Assessment_Areas_Map.mxd



Figure 4b
Pre-Project Functions and Values Wetland and Stream Assessment Areas

Wetland and Stream Functions and Values Assessment Report
Watters Quarry Phase II Project

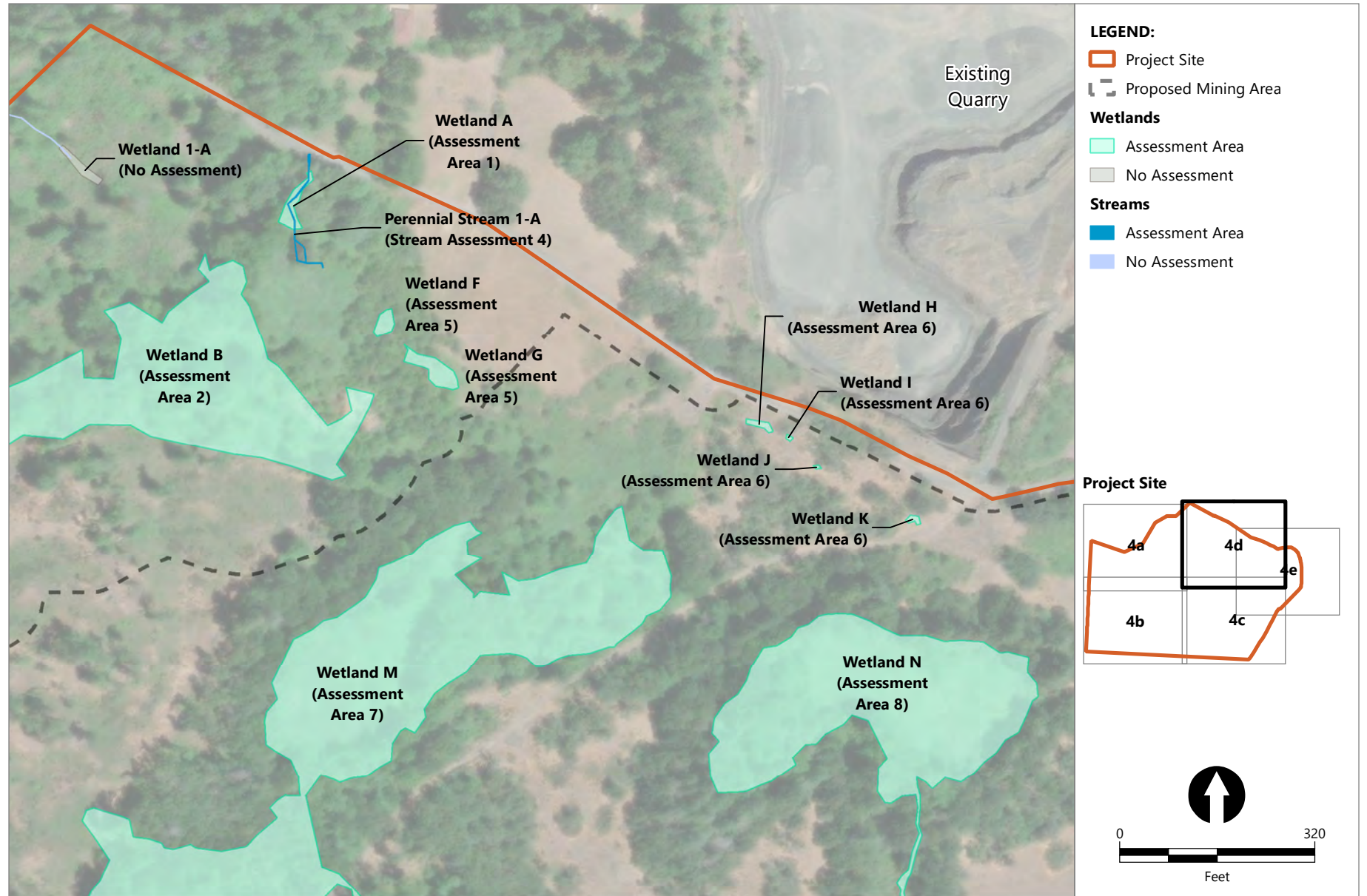


Publish Date: 2023/12/20, 2:43 PM | User: jfox
 Filepath: \\orcas\GIS\Jobs\Knife_River_Corp_2114\Watters_Quarry\Maps\Functions_and_Values_Report\AQ_FVR_Fig4_PreProject_Wetland_Assessment_Areas_Map.mxd



Figure 4c
Pre-Project Functions and Values Wetland and Stream Assessment Areas

Wetland and Stream Functions and Values Assessment Report
 Watters Quarry Phase II Project

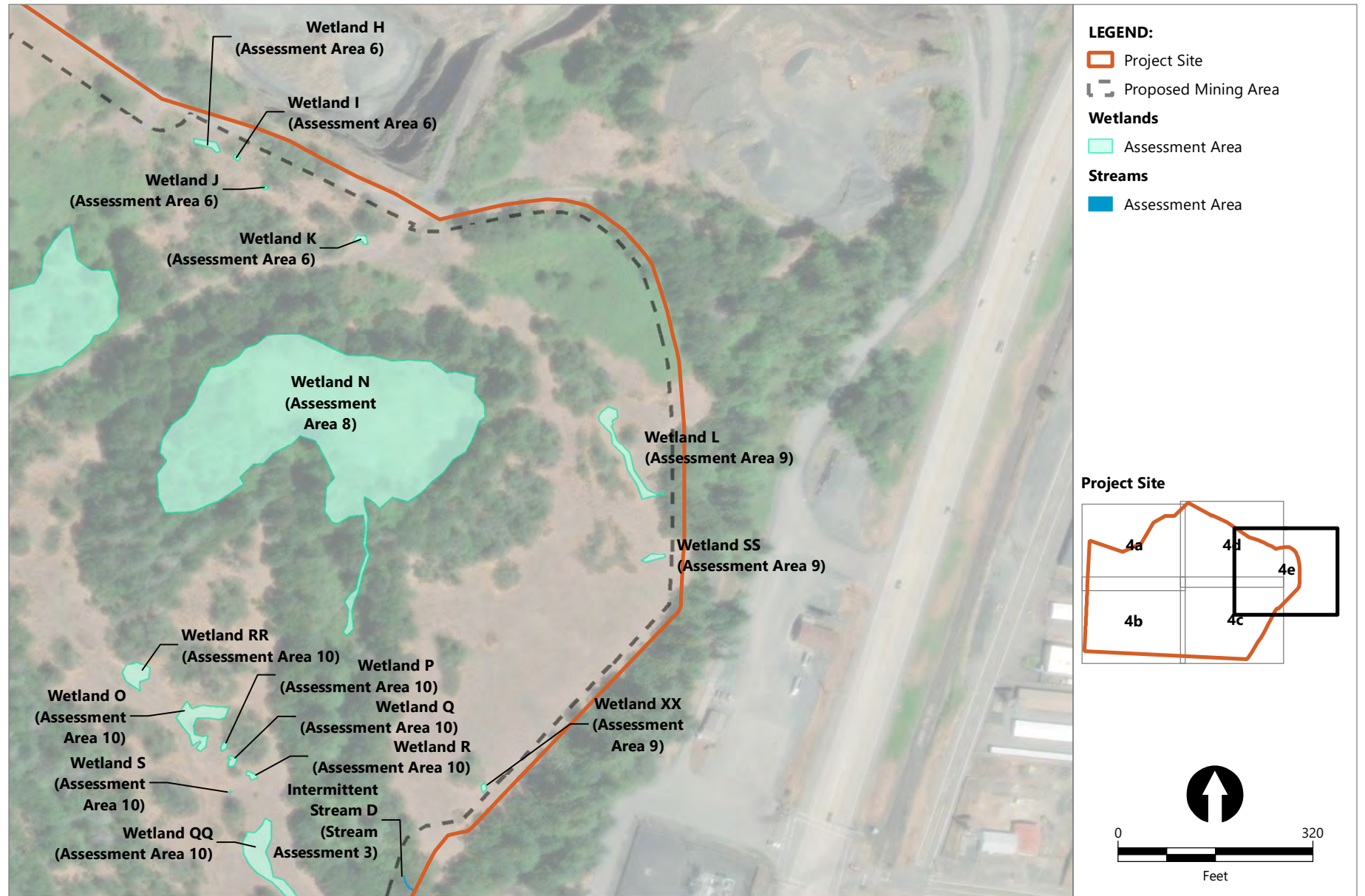


Publish Date: 2023/12/20, 2:43 PM | User: jfox
 Filepath: \\orcas\GIS\Jobs\Knife_River_Corp_2114\Watters_Quarry\Maps\Functions_and_Values_Report\AQ_FVR_Fig4_PreProject_Wetland_Assessment_Areas_Map.mxd



Figure 4d
Pre-Project Functions and Values Wetland and Stream Assessment Areas

Wetland and Stream Functions and Values Assessment Report
 Watters Quarry Phase II Project

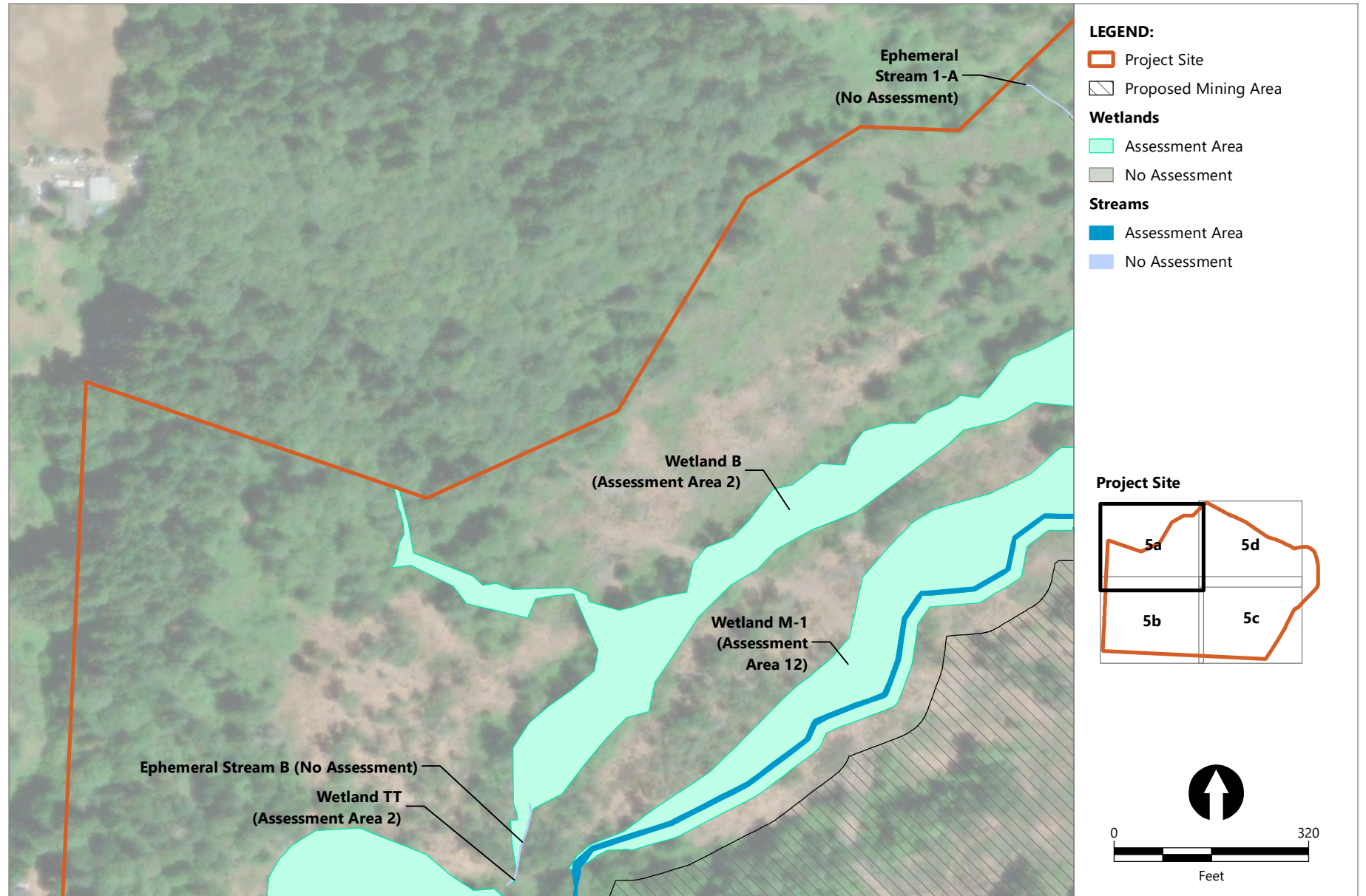


Publish Date: 2023/12/20, 2:43 PM | User: jfox
 Filepath: \\orcas\GIS\Jobs\Knife_River_Corp_2114\Watters_Quarry\Maps\Functions_and_Values_Report\AQ_FVR_Fig4_PreProject_Wetland_Assessment_Areas_Map.mxd



Figure 4e
Pre-Project Functions and Values Wetland and Stream Assessment Areas

Wetland and Stream Functions and Values Assessment Report
 Watters Quarry Phase II Project

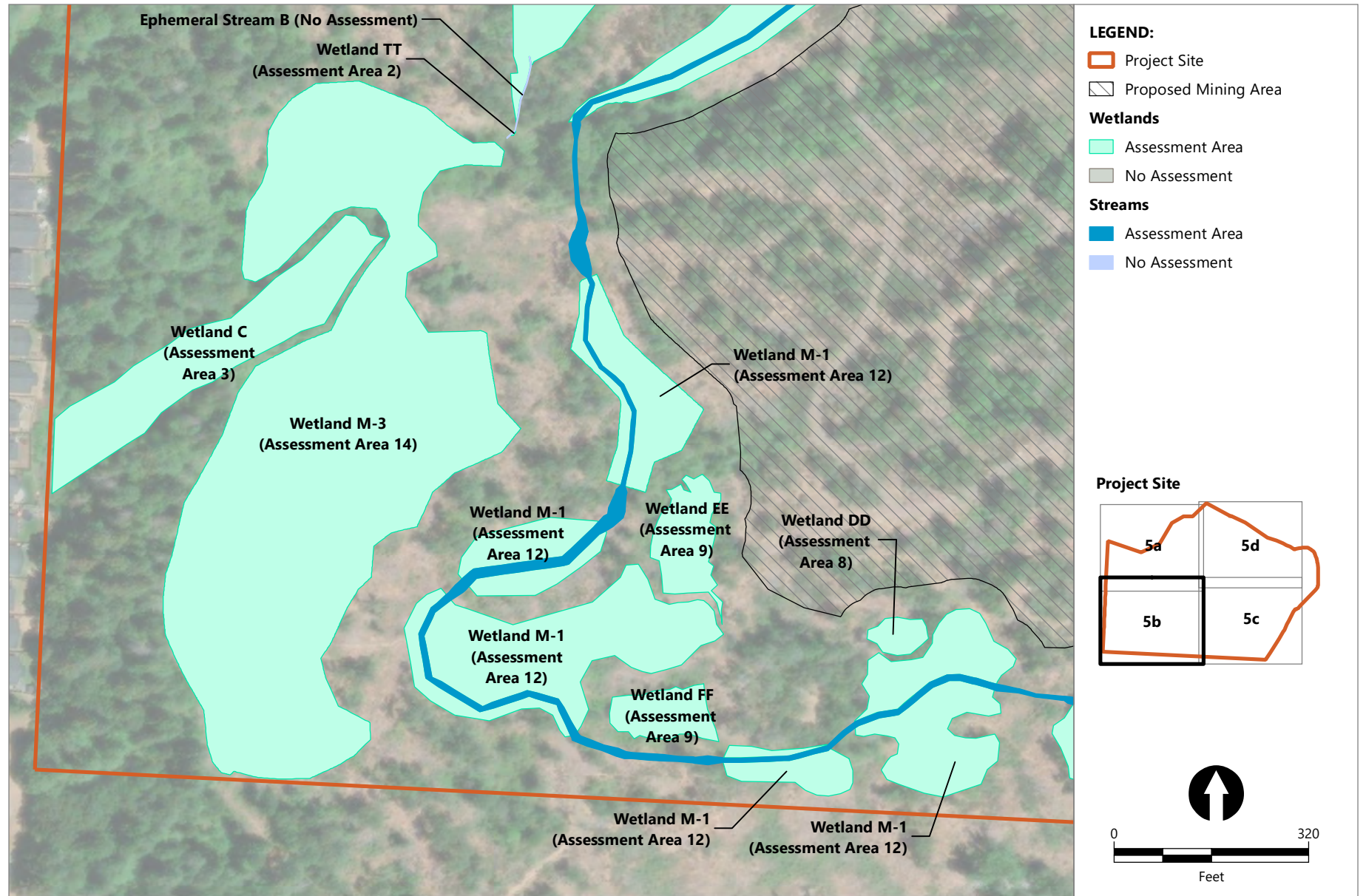


Publish Date: 2023/12/20, 2:44 PM | User: jfox
Filepath: \\orcas\GIS\Jobs\Knife_River_Corp_2114\Watters_Quarry\Maps\Functions_and_Values_Report\AQ_FVR_Fig5_PostProject_Wetland_Assessment_Areas_Map.mxd



Figure 5a
Post-Project Functions and Values Wetland and Stream Assessment Areas

Wetland and Stream Functions and Values Assessment Report
Watters Quarry Phase II Project

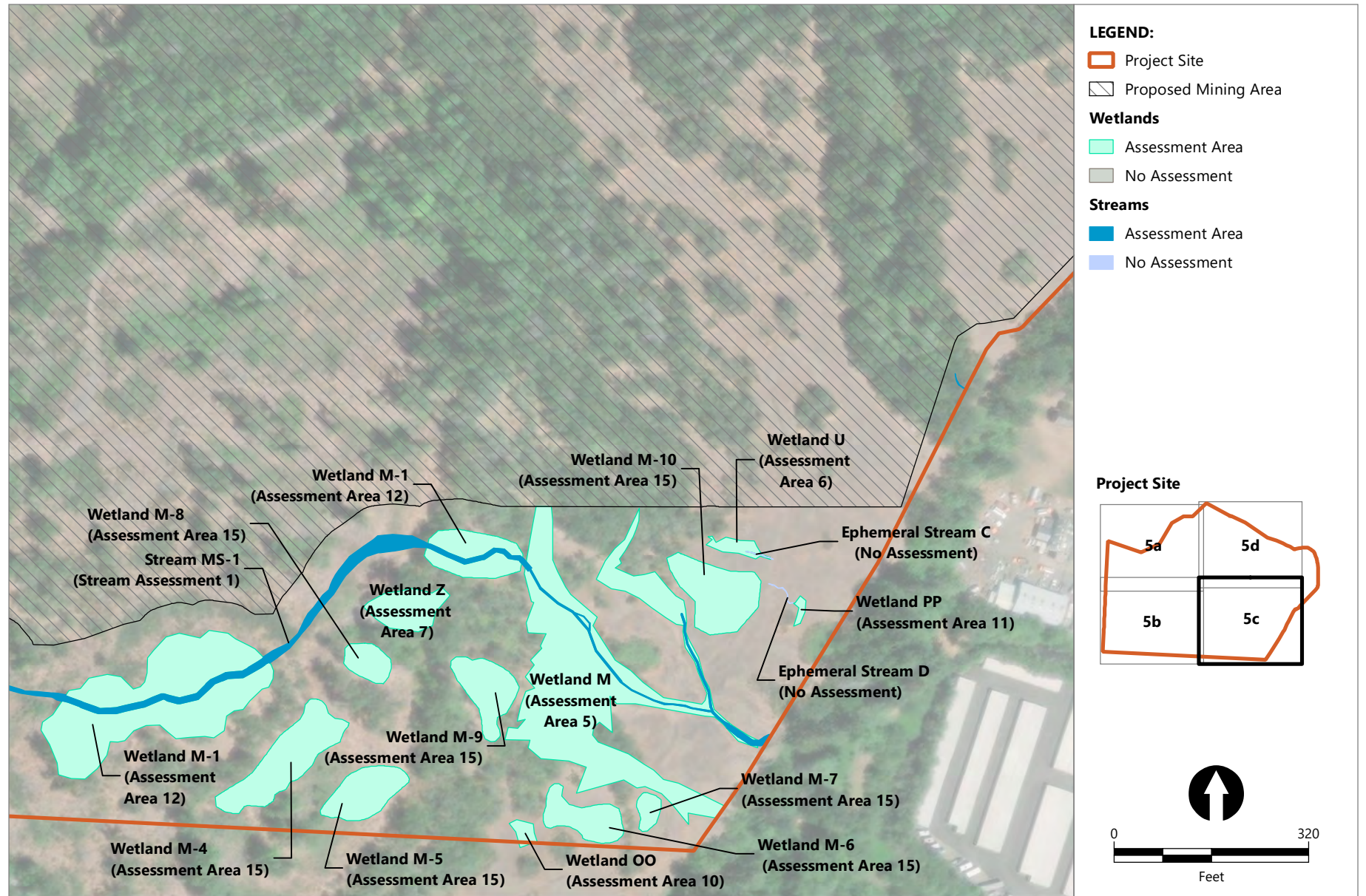


Publish Date: 2023/12/20, 2:44 PM | User: jfox
 Filepath: \\orcas\GIS\Jobs\Knife_River_Corp_2114\Watters_Quarry\Maps\Functions_and_Values_Report\AQ_FVR_Fig5_PostProject_Wetland_Assessment_Areas_Map.mxd



Figure 5b
Post-Project Functions and Values Wetland and Stream Assessment Areas

Wetland and Stream Functions and Values Assessment Report
 Watters Quarry Phase II Project

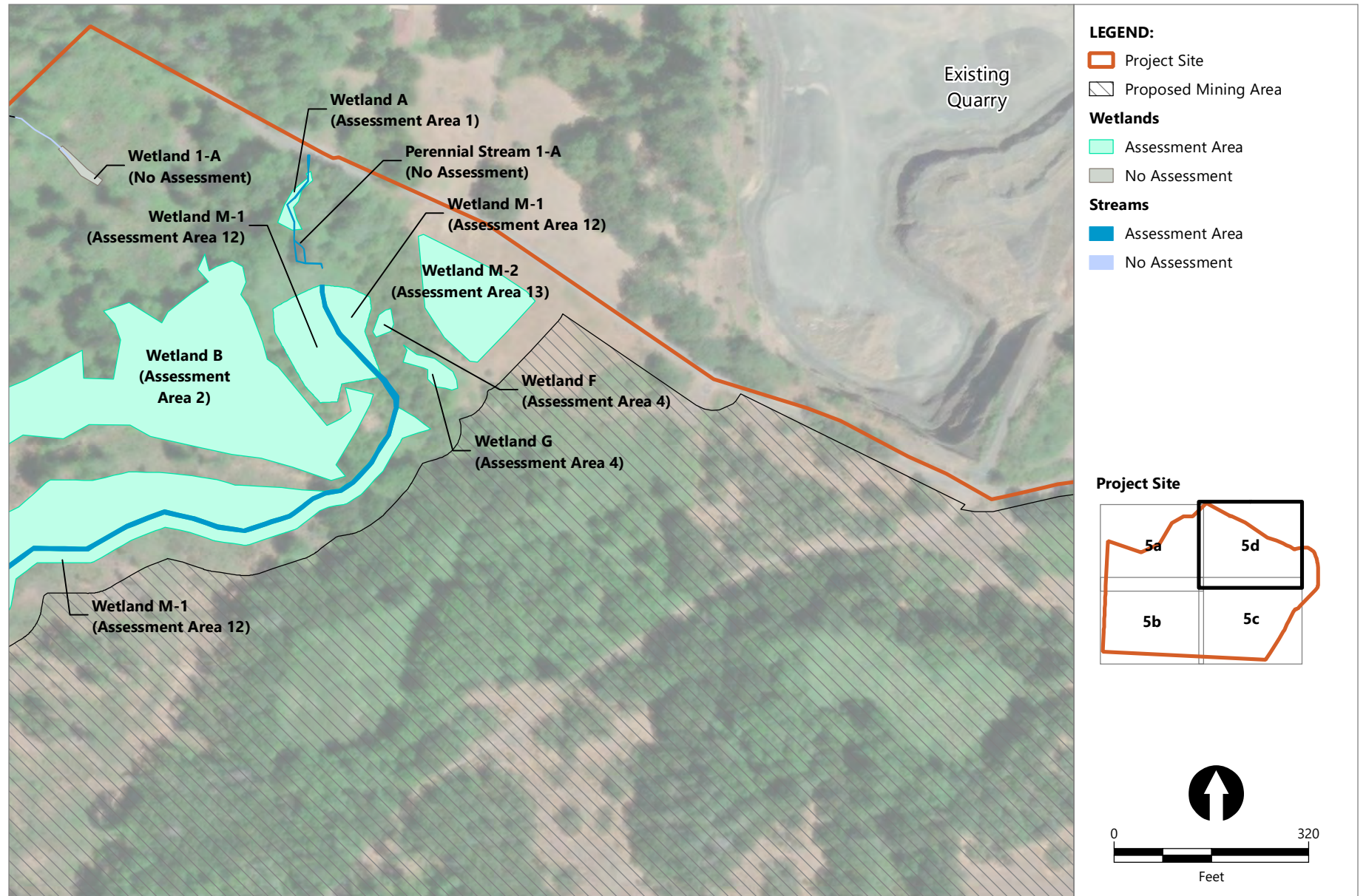


Publish Date: 2023/12/20, 2:44 PM | User: jfox
 Filepath: \\orcas\GIS\Jobs\Knife_River_Corp_2114\Watters_Quarry\Maps\Functions_and_Values_Report\AQ_FVR_Fig5_PostProject_Wetland_Assessment_Areas_Map.mxd



Figure 5c
Post-Project Functions and Values Wetland and Stream Assessment Areas

Wetland and Stream Functions and Values Assessment Report
 Watters Quarry Phase II Project



Publish Date: 2023/12/20, 2:44 PM | User: jfox
 Filepath: \\orcas\GIS\Jobs\Knife_River_Corp_2114\Watters_Quarry\Maps\Functions_and_Values_Report\AQ_FVR_Fig5_PostProject_Wetland_Assessment_Areas_Map.mxd



Figure 5d
Post-Project Functions and Values Wetland and Stream Assessment Areas
 Wetland and Stream Functions and Values Assessment Report
 Watters Quarry Phase II Project

Appendix A

Pre-Project Wetland Functions and Values Assessment Forms

ORWAP Version 3.1. Cover Page: Basic Description of Assessment

Site Name:	Wetland A
Investigator Name:	Julie Fox
Date of Field Assessment:	6/10/2020
County:	Columbia
Nearest Town:	Saint Helens
Latitude (decimal degrees):	
Longitude (decimal degrees):	
TRS, quarter/quarter section and tax lot(s):	
Approximate size of the Assessment Area (AA, in acres):	0.04 acres
AA as percent of entire wetland (approx.). Attach sketch map if AA is smaller than the entire contiguous wetland.	100%
If delineated, DSL file number (WD #) if known:	WD2019-0623
Cowardin Systems & Classes (indicate all present, based on field visit and/or aerial imagery): <u>Systems:</u> Palustrine =P, Riverine =R, Lacustrine =L, Estuarine =E <u>Classes:</u> Emergent =EM, Scrub-Shrub =SS, Forested =FO, Aquatic Bed (incl. SAV) =AB, Open Water =OW, Unconsolidated Bottom =UB, Unconsolidated Shore =US	PSSF
Predominant HGM Class: Estuarine=E, Lacustrine=L, Riverine=R, S= Slope, F= Flats, D= Depressional	Slope
Soil Unit Mapped in Most of the AA:	Rock Outcrop-Xerumbrepts Complex, Undulating
If tidal, the tidal phase during most of visit:	
What percent (approximate) of the wetland were you able to visit?	100%
What percent (approximate) of the AA were you able to visit?	100%
Have you attended an ORWAP training session? If so, indicate approximate month & year.	
How many wetlands have you assessed previously using ORWAP (approximate)?	

Site Name:	Wetland A
Investigator Name:	Julie Fox
Date of Field Assessment:	6/10/2020
<i>Scores will appear below after data are entered in worksheets OF, F, T, and S. See Manual for definitions and descriptions of how scores were computed and ratings assigned.</i>	

Normalized Scores & Ratings for this Assessment Area (AA):						
Specific Functions or Values:	Function Score	Function Rating	Rating Break Proximity	Values Score	Values Rating	Rating Break Proximity
Water Storage & Delay (WS)	4.28	Moderate	LM	7.50	Higher	
Sediment Retention & Stabilization (SR)	3.12	Lower	LM	7.63	Higher	
Phosphorus Retention (PR)	2.56	Lower	LM	4.78	Moderate	
Nitrate Removal & Retention (NR)	2.87	Lower		10.00	Higher	
Anadromous Fish Habitat (FA)	0.00	Lower		0.00	Lower	
Resident Fish Habitat (FR)	0.00	Lower		0.00	Lower	
Amphibian & Reptile Habitat (AM)	7.72	Higher		2.36	Lower	
Waterbird Nesting Habitat (WBN)	7.40	Higher	MH	1.72	Moderate	LM
Waterbird Feeding Habitat (WBF)	9.06	Higher		2.08	Lower	LM
Aquatic Invertebrate Habitat (INV)	6.48	Moderate	MH	1.09	Lower	
Songbird, Raptor, Mammal Habitat (SBM)	3.63	Lower	LM	2.00	Lower	
Water Cooling (WC)	3.59	Moderate		0.61	Lower	
Native Plant Diversity (PD)	7.25	Higher	MH	1.67	Lower	
Pollinator Habitat (POL)	5.56	Moderate		1.03	Lower	
Organic Nutrient Export (OE)	6.31	Moderate				
Carbon Sequestration (CS)	4.12	Moderate	LM			
Public Use & Recognition (PU)				1.76	Lower	

Other Attributes:	Score	Rating	Rating Break Proximity
Wetland Sensitivity (SEN)	1.14	Lower	
Wetland Ecological Condition (EC)	2.99	Moderate	LM
Wetland Stressors (STR)	3.33	Lower	LM

GROUPS	Selected Function	Function Rating	Rating Break Proximity	Values Rating	Rating Break Proximity
Hydrologic Function (WS)	Water Storage & Delay (WS)	Moderate	LM	Higher	
Water Quality Support (SR, PR, or NR)	Sediment Retention & Stabilization (SR)	Lower	LM	Higher	
Fish Habitat (FA or FR)	Anadromous Fish Habitat (FA)	Lower		Lower	
Aquatic Habitat (AM, WBF, or WBN)	Waterbird Nesting Habitat (WBN)	Higher	MH	Moderate	LM
Ecosystem Support (WC, INV, PD, POL, SBM, or OE)	Native Plant Diversity (PD)	Higher	MH	Lower	

ORWAP Version 3.1. Cover Page: Basic Description of Assessment

Site Name:	Wetlands B and TT
Investigator Name:	Julie Fox
Date of Field Assessment:	6/10/2020
County:	Columbia
Nearest Town:	Saint Helens
Latitude (decimal degrees):	
Longitude (decimal degrees):	
TRS, quarter/quarter section and tax lot(s):	
Approximate size of the Assessment Area (AA, in acres):	4.61 acres
AA as percent of entire wetland (approx.). Attach sketch map if AA is smaller than the entire contiguous wetland.	100%
If delineated, DSL file number (WD #) if known:	WD2019-0623
Cowardin Systems & Classes (indicate all present, based on field visit and/or aerial imagery): <u>Systems:</u> Palustrine =P, Riverine =R, Lacustrine =L, Estuarine =E <u>Classes:</u> Emergent =EM, Scrub-Shrub =SS, Forested =FO, Aquatic Bed (incl. SAV) =AB, Open Water =OW, Unconsolidated Bottom =UB, Unconsolidated Shore =US	PFOE/PEMC
Predominant HGM Class: Estuarine=E, Lacustrine=L, Riverine=R, S= Slope, F= Flats, D= Depressional	Slope/Depressional Outflow
Soil Unit Mapped in Most of the AA:	Rock Outcrop-Xerumbrepts Complex, Undulating
If tidal, the tidal phase during most of visit:	
What percent (approximate) of the wetland were you able to visit?	100%
What percent (approximate) of the AA were you able to visit?	100%
Have you attended an ORWAP training session? If so, indicate approximate month & year.	
How many wetlands have you assessed previously using ORWAP (approximate)?	

Site Name:	Wetlands B and TT
Investigator Name:	Julie Fox
Date of Field Assessment:	6/10/2020
<i>Scores will appear below after data are entered in worksheets OF, F, T, and S. See Manual for definitions and descriptions of how scores were computed and ratings assigned.</i>	

<i>Normalized Scores & Ratings for this Assessment Area (AA):</i>						
Specific Functions or Values:	Function Score	Function Rating	Rating Break Proximity	Values Score	Values Rating	Rating Break Proximity
Water Storage & Delay (WS)	4.25	Moderate	LM	7.50	Higher	
Sediment Retention & Stabilization (SR)	4.28	Moderate		6.77	Higher	
Phosphorus Retention (PR)	2.83	Lower	LM	3.76	Moderate	LM
Nitrate Removal & Retention (NR)	4.02	Moderate	LM	10.00	Higher	
Anadromous Fish Habitat (FA)	0.00	Lower		0.00	Lower	
Resident Fish Habitat (FR)	0.00	Lower		0.00	Lower	
Amphibian & Reptile Habitat (AM)	7.82	Higher		2.43	Lower	
Waterbird Nesting Habitat (WBN)	7.72	Higher		1.72	Moderate	LM
Waterbird Feeding Habitat (WBF)	9.53	Higher		2.08	Lower	LM
Aquatic Invertebrate Habitat (INV)	6.10	Moderate		1.15	Lower	
Songbird, Raptor, Mammal Habitat (SBM)	4.63	Moderate		2.00	Lower	
Water Cooling (WC)	10.00	Higher		0.61	Lower	
Native Plant Diversity (PD)	7.82	Higher		2.01	Lower	
Pollinator Habitat (POL)	7.05	Higher	MH	1.03	Lower	
Organic Nutrient Export (OE)	7.28	Higher	MH			
Carbon Sequestration (CS)	5.26	Moderate				
Public Use & Recognition (PU)				1.82	Lower	

Other Attributes:	Score	Rating	Rating Break Proximity
Wetland Sensitivity (SEN)	0.42	Lower	
Wetland Ecological Condition (EC)	2.32	Lower	LM
Wetland Stressors (STR)	3.33	Lower	LM

GROUPS	Selected Function	Function Rating	Rating Break Proximity	Values Rating	Rating Break Proximity
Hydrologic Function (WS)	Water Storage & Delay (WS)	Moderate	LM	Higher	
Water Quality Support (SR, PR, or NR)	Sediment Retention & Stabilization (SR)	Moderate		Higher	
Fish Habitat (FA or FR)	Anadromous Fish Habitat (FA)	Lower		Lower	
Aquatic Habitat (AM, WBF, or WBN)	Waterbird Nesting Habitat (WBN)	Higher		Moderate	LM
Ecosystem Support (WC, INV, PD, POL, SBM, or OE)	Organic Nutrient Export (OE)	Higher	MH	0.00	0.00

ORWAP Version 3.1. Cover Page: Basic Description of Assessment

Site Name:	Wetland C
Investigator Name:	Julie Fox
Date of Field Assessment:	6/10/2020
County:	Columbia
Nearest Town:	Saint Helens
Latitude (decimal degrees):	
Longitude (decimal degrees):	
TRS, quarter/quarter section and tax lot(s):	
Approximate size of the Assessment Area (AA, in acres):	1.33 acres
AA as percent of entire wetland (approx.). Attach sketch map if AA is smaller than the entire contiguous wetland.	100%
If delineated, DSL file number (WD #) if known:	WD2019-0623
Cowardin Systems & Classes (indicate all present, based on field visit and/or aerial imagery): <u>Systems:</u> Palustrine =P, Riverine =R, Lacustrine =L, Estuarine =E <u>Classes:</u> Emergent =EM, Scrub-Shrub =SS, Forested =FO, Aquatic Bed (incl. SAV) =AB, Open Water =OW, Unconsolidated Bottom =UB, Unconsolidated Shore =US	PFOE
Predominant HGM Class: Estuarine=E, Lacustrine=L, Riverine=R, S= Slope, F= Flats, D= Depressional	Slope
Soil Unit Mapped in Most of the AA:	Rock Outcrop-Xerumbrepts Complex, Undulating
If tidal, the tidal phase during most of visit:	
What percent (approximate) of the wetland were you able to visit?	100%
What percent (approximate) of the AA were you able to visit?	100%
Have you attended an ORWAP training session? If so, indicate approximate month & year.	
How many wetlands have you assessed previously using ORWAP (approximate)?	

Site Name:	Wetland C
Investigator Name:	Julie Fox
Date of Field Assessment:	6/10/2020
<i>Scores will appear below after data are entered in worksheets OF, F, T, and S. See Manual for definitions and descriptions of how scores were computed and ratings assigned.</i>	

<i>Normalized Scores & Ratings for this Assessment Area (AA):</i>						
Specific Functions or Values:	Function Score	Function Rating	Rating Break Proximity	Values Score	Values Rating	Rating Break Proximity
Water Storage & Delay (WS)	4.62	Moderate		7.50	Higher	
Sediment Retention & Stabilization (SR)	5.67	Moderate		7.30	Higher	
Phosphorus Retention (PR)	3.41	Moderate	LM	4.25	Moderate	
Nitrate Removal & Retention (NR)	4.91	Moderate		10.00	Higher	
Anadromous Fish Habitat (FA)	0.00	Lower		0.00	Lower	
Resident Fish Habitat (FR)	0.00	Lower		0.00	Lower	
Amphibian & Reptile Habitat (AM)	7.82	Higher		2.43	Lower	
Waterbird Nesting Habitat (WBN)	7.72	Higher		1.72	Moderate	LM
Waterbird Feeding Habitat (WBF)	9.53	Higher		2.08	Lower	LM
Aquatic Invertebrate Habitat (INV)	7.90	Higher		1.15	Lower	
Songbird, Raptor, Mammal Habitat (SBM)	4.63	Moderate		2.00	Lower	
Water Cooling (WC)	7.20	Higher		0.61	Lower	
Native Plant Diversity (PD)	8.00	Higher		2.01	Lower	
Pollinator Habitat (POL)	7.05	Higher	MH	1.03	Lower	
Organic Nutrient Export (OE)	7.13	Higher	MH			
Carbon Sequestration (CS)	5.56	Moderate				
Public Use & Recognition (PU)				1.82	Lower	

Other Attributes:	Score	Rating	Rating Break Proximity
Wetland Sensitivity (SEN)	1.03	Lower	
Wetland Ecological Condition (EC)	2.32	Lower	LM
Wetland Stressors (STR)	5.00	Moderate	

GROUPS	Selected Function	Function Rating	Rating Break Proximity	Values Rating	Rating Break Proximity
Hydrologic Function (WS)	Water Storage & Delay (WS)	Moderate		Higher	
Water Quality Support (SR, PR, or NR)	Sediment Retention & Stabilization (SR)	Moderate		Higher	
Fish Habitat (FA or FR)	Anadromous Fish Habitat (FA)	Lower		Lower	
Aquatic Habitat (AM, WBF, or WBN)	Waterbird Nesting Habitat (WBN)	Higher		Moderate	LM
Ecosystem Support (WC, INV, PD, POL, SBM, or OE)	Organic Nutrient Export (OE)	Higher	MH	0.00	0.00

ORWAP Version 3.1. Cover Page: Basic Description of Assessment

Site Name:	Wetlands D and E
Investigator Name:	Julie Fox
Date of Field Assessment:	6/10/2020
County:	Columbia
Nearest Town:	Saint Helens
Latitude (decimal degrees):	
Longitude (decimal degrees):	
TRS, quarter/quarter section and tax lot(s):	
Approximate size of the Assessment Area (AA, in acres):	1.10 acres
AA as percent of entire wetland (approx.). Attach sketch map if AA is smaller than the entire contiguous wetland.	100%
If delineated, DSL file number (WD #) if known:	WD2019-0623
Cowardin Systems & Classes (indicate all present, based on field visit and/or aerial imagery): <u>Systems:</u> Palustrine =P, Riverine =R, Lacustrine =L, Estuarine =E <u>Classes:</u> Emergent =EM, Scrub-Shrub =SS, Forested =FO, Aquatic Bed (incl. SAV) =AB, Open Water =OW, Unconsolidated Bottom =UB, Unconsolidated Shore =US	PFOE
Predominant HGM Class: Estuarine=E, Lacustrine=L, Riverine=R, S= Slope, F= Flats, D= Depressional	Slope
Soil Unit Mapped in Most of the AA:	Rock Outcrop-Xerumbrepts Complex, Undulating
If tidal, the tidal phase during most of visit:	
What percent (approximate) of the wetland were you able to visit?	100%
What percent (approximate) of the AA were you able to visit?	100%
Have you attended an ORWAP training session? If so, indicate approximate month & year.	
How many wetlands have you assessed previously using ORWAP (approximate)?	

Site Name:	Wetlands D and E
Investigator Name:	Julie Fox
Date of Field Assessment:	6/10/2020
<i>Scores will appear below after data are entered in worksheets OF, F, T, and S. See Manual for definitions and descriptions of how scores were computed and ratings assigned.</i>	

<i>Normalized Scores & Ratings for this Assessment Area (AA):</i>						
Specific Functions or Values:	Function Score	Function Rating	Rating Break Proximity	Values Score	Values Rating	Rating Break Proximity
Water Storage & Delay (WS)	4.89	Moderate		7.50	Higher	
Sediment Retention & Stabilization (SR)	4.53	Moderate		6.77	Higher	
Phosphorus Retention (PR)	2.91	Lower	LM	3.55	Moderate	LM
Nitrate Removal & Retention (NR)	3.77	Lower	LM	10.00	Higher	
Anadromous Fish Habitat (FA)	0.00	Lower		0.00	Lower	
Resident Fish Habitat (FR)	0.00	Lower		0.00	Lower	
Amphibian & Reptile Habitat (AM)	7.96	Higher		2.45	Lower	
Waterbird Nesting Habitat (WBN)	8.35	Higher		1.72	Moderate	LM
Waterbird Feeding Habitat (WBF)	9.68	Higher		2.08	Lower	LM
Aquatic Invertebrate Habitat (INV)	5.19	Moderate		1.17	Lower	
Songbird, Raptor, Mammal Habitat (SBM)	4.58	Moderate		2.00	Lower	
Water Cooling (WC)	3.55	Moderate		0.61	Lower	
Native Plant Diversity (PD)	7.70	Higher		1.98	Lower	
Pollinator Habitat (POL)	6.86	Higher	MH	1.03	Lower	
Organic Nutrient Export (OE)	6.22	Moderate				
Carbon Sequestration (CS)	3.71	Lower	LM			
Public Use & Recognition (PU)				1.80	Lower	

Other Attributes:	Score	Rating	Rating Break Proximity
Wetland Sensitivity (SEN)	0.45	Lower	
Wetland Ecological Condition (EC)	1.61	Lower	
Wetland Stressors (STR)	3.33	Lower	LM

GROUPS	Selected Function	Function Rating	Rating Break Proximity	Values Rating	Rating Break Proximity
Hydrologic Function (WS)	Water Storage & Delay (WS)	Moderate		Higher	
Water Quality Support (SR, PR, or NR)	Sediment Retention & Stabilization (SR)	Moderate		Higher	
Fish Habitat (FA or FR)	Anadromous Fish Habitat (FA)	Lower		Lower	
Aquatic Habitat (AM, WBF, or WBN)	Waterbird Nesting Habitat (WBN)	Higher		Moderate	LM
Ecosystem Support (WC, INV, PD, POL, SBM, or OE)	Native Plant Diversity (PD)	Higher		Lower	

ORWAP Version 3.1. Cover Page: Basic Description of Assessment

Site Name:	Wetlands F and G
Investigator Name:	Julie Fox
Date of Field Assessment:	6/10/2020
County:	Columbia
Nearest Town:	St. Helens
Latitude (decimal degrees):	
Longitude (decimal degrees):	
TRS, quarter/quarter section and tax lot(s):	
Approximate size of the Assessment Area (AA, in acres):	0.08 acres
AA as percent of entire wetland (approx.). Attach sketch map if AA is smaller than the entire contiguous wetland.	100%
If delineated, DSL file number (WD #) if known:	WD2019-0623
Cowardin Systems & Classes (indicate all present, based on field visit and/or aerial imagery): <u>Systems:</u> Palustrine =P, Riverine =R, Lacustrine =L, Estuarine =E <u>Classes:</u> Emergent =EM, Scrub-Shrub =SS, Forested =FO, Aquatic Bed (incl. SAV) =AB, Open Water =OW, Unconsolidated Bottom =UB, Unconsolidated Shore =US	PEME
Predominant HGM Class: Estuarine=E, Lacustrine=L, Riverine=R, S= Slope, F= Flats, D= Depressional	Depressional
Soil Unit Mapped in Most of the AA:	Rock Outcrop-Xerumbrepts Complex, Undulating
If tidal, the tidal phase during most of visit:	
What percent (approximate) of the wetland were you able to visit?	100%
What percent (approximate) of the AA were you able to visit?	100%
Have you attended an ORWAP training session? If so, indicate approximate month & year.	
How many wetlands have you assessed previously using ORWAP (approximate)?	

Site Name:	Wetlands F and G
Investigator Name:	Julie Fox
Date of Field Assessment:	6/10/2020
<i>Scores will appear below after data are entered in worksheets OF, F, T, and S. See Manual for definitions and descriptions of how scores were computed and ratings assigned.</i>	

<i>Normalized Scores & Ratings for this Assessment Area (AA):</i>						
Specific Functions or Values:	Function Score	Function Rating	Rating Break Proximity	Values Score	Values Rating	Rating Break Proximity
Water Storage & Delay (WS)	10.00	Higher		7.50	Higher	
Sediment Retention & Stabilization (SR)	10.00	Higher		6.77	Higher	
Phosphorus Retention (PR)	10.00	Higher		3.55	Moderate	LM
Nitrate Removal & Retention (NR)	10.00	Higher		10.00	Higher	
Anadromous Fish Habitat (FA)	0.00	Lower		0.00	Lower	
Resident Fish Habitat (FR)	0.00	Lower		0.00	Lower	
Amphibian & Reptile Habitat (AM)	7.56	Higher		2.32	Lower	
Waterbird Nesting Habitat (WBN)	6.44	Moderate		1.72	Moderate	LM
Waterbird Feeding Habitat (WBF)	8.73	Higher		2.08	Lower	LM
Aquatic Invertebrate Habitat (INV)	3.51	Lower		1.07	Lower	
Songbird, Raptor, Mammal Habitat (SBM)	3.62	Lower	LM	2.00	Lower	
Water Cooling (WC)	1.88	Lower	LM	0.00	Lower	
Native Plant Diversity (PD)	0.00	Lower		0.00	Lower	
Pollinator Habitat (POL)	5.43	Moderate		1.03	Lower	
Organic Nutrient Export (OE)	0.00	Lower				
Carbon Sequestration (CS)	5.07	Moderate				
Public Use & Recognition (PU)				1.76	Lower	

Other Attributes:	Score	Rating	Rating Break Proximity
Wetland Sensitivity (SEN)	1.35	Lower	
Wetland Ecological Condition (EC)	4.07	Moderate	
Wetland Stressors (STR)	5.00	Moderate	

GROUPS	Selected Function	Function Rating	Rating Break Proximity	Values Rating	Rating Break Proximity
Hydrologic Function (WS)	Water Storage & Delay (WS)	Higher		Higher	
Water Quality Support (SR, PR, or NR)	Sediment Retention & Stabilization (SR)	Higher		Higher	
Fish Habitat (FA or FR)	Anadromous Fish Habitat (FA)	Lower		Lower	
Aquatic Habitat (AM, WBF, or WBN)	Amphibian & Reptile Habitat (AM)	Higher		Lower	
Ecosystem Support (WC, INV, PD, POL, SBM, or OE)	Pollinator Habitat (POL)	Moderate		Lower	

ORWAP Version 3.1. Cover Page: Basic Description of Assessment

Site Name:	Wetlands H, I, J, and K
Investigator Name:	Julie Fox
Date of Field Assessment:	6/10/2020
County:	Columbia
Nearest Town:	St. Helens
Latitude (decimal degrees):	
Longitude (decimal degrees):	
TRS, quarter/quarter section and tax lot(s):	
Approximate size of the Assessment Area (AA, in acres):	0.018 acres
AA as percent of entire wetland (approx.). Attach sketch map if AA is smaller than the entire contiguous wetland.	100%
If delineated, DSL file number (WD #) if known:	WD2019-0623
Cowardin Systems & Classes (indicate all present, based on field visit and/or aerial imagery): <u>Systems:</u> Palustrine =P, Riverine =R, Lacustrine =L, Estuarine =E <u>Classes:</u> Emergent =EM, Scrub-Shrub =SS, Forested =FO, Aquatic Bed (incl. SAV) =AB, Open Water =OW, Unconsolidated Bottom =UB, Unconsolidated Shore =US	PEMC
Predominant HGM Class: Estuarine=E, Lacustrine=L, Riverine=R, S= Slope, F= Flats, D= Depressional	Depressional
Soil Unit Mapped in Most of the AA:	Rock Outcrop-Xerumbrepts Complex, Undulating
If tidal, the tidal phase during most of visit:	
What percent (approximate) of the wetland were you able to visit?	100%
What percent (approximate) of the AA were you able to visit?	100%
Have you attended an ORWAP training session? If so, indicate approximate month & year.	
How many wetlands have you assessed previously using ORWAP (approximate)?	

Site Name:	Wetlands H, I, J, and K
Investigator Name:	Julie Fox
Date of Field Assessment:	6/10/2020
<i>Scores will appear below after data are entered in worksheets OF, F, T, and S. See Manual for definitions and descriptions of how scores were computed and ratings assigned.</i>	

<i>Normalized Scores & Ratings for this Assessment Area (AA):</i>						
Specific Functions or Values:	Function Score	Function Rating	Rating Break Proximity	Values Score	Values Rating	Rating Break Proximity
Water Storage & Delay (WS)	10.00	Higher		7.50	Higher	
Sediment Retention & Stabilization (SR)	10.00	Higher		6.77	Higher	
Phosphorus Retention (PR)	10.00	Higher		3.55	Moderate	LM
Nitrate Removal & Retention (NR)	10.00	Higher		10.00	Higher	
Anadromous Fish Habitat (FA)	0.00	Lower		0.00	Lower	
Resident Fish Habitat (FR)	0.00	Lower		0.00	Lower	
Amphibian & Reptile Habitat (AM)	7.63	Higher		2.35	Lower	
Waterbird Nesting Habitat (WBN)	7.74	Higher		1.72	Moderate	LM
Waterbird Feeding Habitat (WBF)	9.00	Higher		2.08	Lower	LM
Aquatic Invertebrate Habitat (INV)	6.35	Moderate	MH	1.03	Lower	
Songbird, Raptor, Mammal Habitat (SBM)	2.43	Lower		2.00	Lower	
Water Cooling (WC)	2.25	Lower	LM	0.00	Lower	
Native Plant Diversity (PD)	0.00	Lower		0.00	Lower	
Pollinator Habitat (POL)	5.11	Moderate		1.03	Lower	
Organic Nutrient Export (OE)	0.00	Lower				
Carbon Sequestration (CS)	4.14	Moderate	LM			
Public Use & Recognition (PU)				1.88	Lower	

Other Attributes:	Score	Rating	Rating Break Proximity
Wetland Sensitivity (SEN)	1.45	Lower	
Wetland Ecological Condition (EC)	1.21	Lower	
Wetland Stressors (STR)	5.00	Moderate	

GROUPS	Selected Function	Function Rating	Rating Break Proximity	Values Rating	Rating Break Proximity
Hydrologic Function (WS)	Water Storage & Delay (WS)	Higher		Higher	
Water Quality Support (SR, PR, or NR)	Sediment Retention & Stabilization (SR)	Higher		Higher	
Fish Habitat (FA or FR)	Anadromous Fish Habitat (FA)	Lower		Lower	
Aquatic Habitat (AM, WBF, or WBN)	Waterbird Nesting Habitat (WBN)	Higher		Moderate	LM
Ecosystem Support (WC, INV, PD, POL, SBM, or OE)	Aquatic Invertebrate Habitat (INV)	Moderate	MH	Lower	

ORWAP Version 3.1. Cover Page: Basic Description of Assessment

Site Name:	Wetland M
Investigator Name:	Julie Fox
Date of Field Assessment:	6/11/2020
County:	Columbia
Nearest Town:	St. Helens
Latitude (decimal degrees):	
Longitude (decimal degrees):	
TRS, quarter/quarter section and tax lot(s):	
Approximate size of the Assessment Area (AA, in acres):	7.08 acres
AA as percent of entire wetland (approx.). Attach sketch map if AA is smaller than the entire contiguous wetland.	100%
If delineated, DSL file number (WD #) if known:	WD2019-0623
Cowardin Systems & Classes (indicate all present, based on field visit and/or aerial imagery): <u>Systems:</u> Palustrine =P, Riverine =R, Lacustrine =L, Estuarine =E <u>Classes:</u> Emergent =EM, Scrub-Shrub =SS, Forested =FO, Aquatic Bed (incl. SAV) =AB, Open Water =OW, Unconsolidated Bottom =UB, Unconsolidated Shore =US	PFOE/PEMC
Predominant HGM Class: Estuarine=E, Lacustrine=L, Riverine=R, S= Slope, F= Flats, D= Depressional	Depressional Outflow
Soil Unit Mapped in Most of the AA:	Rock Outcrop-Xerumbrepts Complex, Undulating
If tidal, the tidal phase during most of visit:	
What percent (approximate) of the wetland were you able to visit?	100%
What percent (approximate) of the AA were you able to visit?	100%
Have you attended an ORWAP training session? If so, indicate approximate month & year.	
How many wetlands have you assessed previously using ORWAP (approximate)?	

Site Name:	Wetland M
Investigator Name:	Julie Fox
Date of Field Assessment:	6/11/2020
<i>Scores will appear below after data are entered in worksheets OF, F, T, and S. See Manual for definitions and descriptions of how scores were computed and ratings assigned.</i>	

<i>Normalized Scores & Ratings for this Assessment Area (AA):</i>						
Specific Functions or Values:	Function Score	Function Rating	Rating Break Proximity	Values Score	Values Rating	Rating Break Proximity
Water Storage & Delay (WS)	3.08	Lower		7.50	Higher	
Sediment Retention & Stabilization (SR)	4.01	Moderate	LM	7.30	Higher	
Phosphorus Retention (PR)	2.74	Lower	LM	4.18	Moderate	
Nitrate Removal & Retention (NR)	4.33	Moderate	LM	10.00	Higher	
Anadromous Fish Habitat (FA)	0.00	Lower		0.00	Lower	
Resident Fish Habitat (FR)	0.00	Lower		0.00	Lower	
Amphibian & Reptile Habitat (AM)	8.55	Higher		2.41	Lower	
Waterbird Nesting Habitat (WBN)	8.20	Higher		1.72	Moderate	LM
Waterbird Feeding Habitat (WBF)	9.41	Higher		2.08	Lower	LM
Aquatic Invertebrate Habitat (INV)	7.77	Higher		1.20	Lower	
Songbird, Raptor, Mammal Habitat (SBM)	5.09	Moderate	MH	2.00	Lower	
Water Cooling (WC)	2.95	Moderate	LM	1.06	Lower	
Native Plant Diversity (PD)	8.12	Higher		10.00	Higher	
Pollinator Habitat (POL)	7.29	Higher	MH	1.03	Lower	
Organic Nutrient Export (OE)	6.96	Higher	MH			
Carbon Sequestration (CS)	3.96	Moderate	LM			
Public Use & Recognition (PU)				1.81	Lower	

Other Attributes:	Score	Rating	Rating Break Proximity
Wetland Sensitivity (SEN)	5.47	Higher	
Wetland Ecological Condition (EC)	3.53	Moderate	LM
Wetland Stressors (STR)	3.33	Lower	LM

GROUPS	Selected Function	Function Rating	Rating Break Proximity	Values Rating	Rating Break Proximity
Hydrologic Function (WS)	Water Storage & Delay (WS)	Lower		Higher	
Water Quality Support (SR, PR, or NR)	Sediment Retention & Stabilization (SR)	Moderate	LM	Higher	
Fish Habitat (FA or FR)	Anadromous Fish Habitat (FA)	Lower		Lower	
Aquatic Habitat (AM, WBF, or WBN)	Waterbird Nesting Habitat (WBN)	Higher		Moderate	LM
Ecosystem Support (WC, INV, PD, POL, SBM, or OE)	Native Plant Diversity (PD)	Higher		Higher	

ORWAP Version 3.1. Cover Page: Basic Description of Assessment

Site Name:	Wetland N
Investigator Name:	Julie Fox
Date of Field Assessment:	6/11/2020
County:	Columbia
Nearest Town:	St. Helens
Latitude (decimal degrees):	
Longitude (decimal degrees):	
TRS, quarter/quarter section and tax lot(s):	
Approximate size of the Assessment Area (AA, in acres):	2.43 acres
AA as percent of entire wetland (approx.). Attach sketch map if AA is smaller than the entire contiguous wetland.	100%
If delineated, DSL file number (WD #) if known:	WD2019-0623
Cowardin Systems & Classes (indicate all present, based on field visit and/or aerial imagery): <u>Systems:</u> Palustrine =P, Riverine =R, Lacustrine =L, Estuarine =E <u>Classes:</u> Emergent =EM, Scrub-Shrub =SS, Forested =FO, Aquatic Bed (incl. SAV) =AB, Open Water =OW, Unconsolidated Bottom =UB, Unconsolidated Shore =US	PFOE
Predominant HGM Class: Estuarine=E, Lacustrine=L, Riverine=R, S= Slope, F= Flats, D= Depressional	Depressional Outflow
Soil Unit Mapped in Most of the AA:	Rock Outcrop-Xerumbrepts Complex, Undulating
If tidal, the tidal phase during most of visit:	
What percent (approximate) of the wetland were you able to visit?	100%
What percent (approximate) of the AA were you able to visit?	100%
Have you attended an ORWAP training session? If so, indicate approximate month & year.	
How many wetlands have you assessed previously using ORWAP (approximate)?	

Site Name:	Wetland N
Investigator Name:	Julie Fox
Date of Field Assessment:	6/11/2020
<i>Scores will appear below after data are entered in worksheets OF, F, T, and S. See Manual for definitions and descriptions of how scores were computed and ratings assigned.</i>	

<i>Normalized Scores & Ratings for this Assessment Area (AA):</i>						
Specific Functions or Values:	Function Score	Function Rating	Rating Break Proximity	Values Score	Values Rating	Rating Break Proximity
Water Storage & Delay (WS)	4.19	Moderate	LM	7.50	Higher	
Sediment Retention & Stabilization (SR)	3.84	Moderate	LM	6.77	Higher	
Phosphorus Retention (PR)	2.79	Lower	LM	3.55	Moderate	LM
Nitrate Removal & Retention (NR)	3.28	Lower	LM	10.00	Higher	
Anadromous Fish Habitat (FA)	0.00	Lower		0.00	Lower	
Resident Fish Habitat (FR)	0.00	Lower		0.00	Lower	
Amphibian & Reptile Habitat (AM)	8.20	Higher		2.41	Lower	
Waterbird Nesting Habitat (WBN)	8.16	Higher		1.72	Moderate	LM
Waterbird Feeding Habitat (WBF)	9.43	Higher		2.08	Lower	LM
Aquatic Invertebrate Habitat (INV)	6.14	Moderate		1.14	Lower	
Songbird, Raptor, Mammal Habitat (SBM)	3.82	Moderate	LM	2.00	Lower	
Water Cooling (WC)	9.24	Higher		0.61	Lower	
Native Plant Diversity (PD)	7.68	Higher		1.74	Lower	
Pollinator Habitat (POL)	5.87	Moderate		1.03	Lower	
Organic Nutrient Export (OE)	6.94	Higher	MH			
Carbon Sequestration (CS)	5.16	Moderate				
Public Use & Recognition (PU)				1.81	Lower	

Other Attributes:	Score	Rating	Rating Break Proximity
Wetland Sensitivity (SEN)	0.67	Lower	
Wetland Ecological Condition (EC)	3.43	Moderate	LM
Wetland Stressors (STR)	3.33	Lower	LM

GROUPS	Selected Function	Function Rating	Rating Break Proximity	Values Rating	Rating Break Proximity
Hydrologic Function (WS)	Water Storage & Delay (WS)	Moderate	LM	Higher	
Water Quality Support (SR, PR, or NR)	Sediment Retention & Stabilization (SR)	Moderate	LM	Higher	
Fish Habitat (FA or FR)	Anadromous Fish Habitat (FA)	Lower		Lower	
Aquatic Habitat (AM, WBF, or WBN)	Waterbird Nesting Habitat (WBN)	Higher		Moderate	LM
Ecosystem Support (WC, INV, PD, POL, SBM, or OE)	Organic Nutrient Export (OE)	Higher	MH	0.00	0.00

ORWAP Version 3.1. Cover Page: Basic Description of Assessment

Site Name:	Wetlands L, SS, and XX
Investigator Name:	Julie Fox
Date of Field Assessment:	6/10/2020
County:	Columbia
Nearest Town:	St. Helens
Latitude (decimal degrees):	
Longitude (decimal degrees):	
TRS, quarter/quarter section and tax lot(s):	
Approximate size of the Assessment Area (AA, in acres):	0.07 acres
AA as percent of entire wetland (approx.). Attach sketch map if AA is smaller than the entire contiguous wetland.	100%
If delineated, DSL file number (WD #) if known:	WD2019-0623
Cowardin Systems & Classes (indicate all present, based on field visit and/or aerial imagery): <u>Systems:</u> Palustrine =P, Riverine =R, Lacustrine =L, Estuarine =E <u>Classes:</u> Emergent =EM, Scrub-Shrub =SS, Forested =FO, Aquatic Bed (incl. SAV) =AB, Open Water =OW, Unconsolidated Bottom =UB, Unconsolidated Shore =US	PEMC
Predominant HGM Class: Estuarine=E, Lacustrine=L, Riverine=R, S= Slope, F= Flats, D= Depressional	Depressional/Depressional Outflow
Soil Unit Mapped in Most of the AA:	Rock Outcrop-Xerumbrepts Complex, Undulating
If tidal, the tidal phase during most of visit:	
What percent (approximate) of the wetland were you able to visit?	100%
What percent (approximate) of the AA were you able to visit?	100%
Have you attended an ORWAP training session? If so, indicate approximate month & year.	
How many wetlands have you assessed previously using ORWAP (approximate)?	

Site Name:	Wetlands L, SS, and XX
Investigator Name:	Julie Fox
Date of Field Assessment:	6/10/2020
<i>Scores will appear below after data are entered in worksheets OF, F, T, and S. See Manual for definitions and descriptions of how scores were computed and ratings assigned.</i>	

<i>Normalized Scores & Ratings for this Assessment Area (AA):</i>						
Specific Functions or Values:	Function Score	Function Rating	Rating Break Proximity	Values Score	Values Rating	Rating Break Proximity
Water Storage & Delay (WS)	3.97	Lower	LM	7.50	Higher	
Sediment Retention & Stabilization (SR)	2.78	Lower		6.77	Higher	
Phosphorus Retention (PR)	2.17	Lower		3.55	Moderate	LM
Nitrate Removal & Retention (NR)	2.53	Lower		10.00	Higher	
Anadromous Fish Habitat (FA)	0.00	Lower		0.00	Lower	
Resident Fish Habitat (FR)	0.00	Lower		0.00	Lower	
Amphibian & Reptile Habitat (AM)	7.86	Higher		1.11	Lower	
Waterbird Nesting Habitat (WBN)	0.00	Lower		0.00	Lower	
Waterbird Feeding Habitat (WBF)	0.00	Lower		0.00	Lower	
Aquatic Invertebrate Habitat (INV)	4.11	Lower	LM	0.64	Lower	
Songbird, Raptor, Mammal Habitat (SBM)	2.26	Lower		2.00	Lower	
Water Cooling (WC)	5.38	Higher	MH	0.61	Lower	
Native Plant Diversity (PD)	6.05	Moderate	MH	10.00	Higher	
Pollinator Habitat (POL)	5.25	Moderate		1.03	Lower	
Organic Nutrient Export (OE)	7.48	Higher				
Carbon Sequestration (CS)	3.24	Lower				
Public Use & Recognition (PU)				1.88	Lower	

Other Attributes:	Score	Rating	Rating Break Proximity
Wetland Sensitivity (SEN)	4.53	Higher	MH
Wetland Ecological Condition (EC)	0.72	Lower	
Wetland Stressors (STR)	3.33	Lower	LM

GROUPS	Selected Function	Function Rating	Rating Break Proximity	Values Rating	Rating Break Proximity
Hydrologic Function (WS)	Water Storage & Delay (WS)	Lower	LM	Higher	
Water Quality Support (SR, PR, or NR)	Sediment Retention & Stabilization (SR)	Lower		Higher	
Fish Habitat (FA or FR)	Anadromous Fish Habitat (FA)	Lower		Lower	
Aquatic Habitat (AM, WBF, or WBN)	Amphibian & Reptile Habitat (AM)	Higher		Lower	
Ecosystem Support (WC, INV, PD, POL, SBM, or OE)	Organic Nutrient Export (OE)	Higher		0.00	0.00

ORWAP Version 3.1. Cover Page: Basic Description of Assessment

Site Name:	Wetlands O through T, QQ, and RR
Investigator Name:	Julie Fox
Date of Field Assessment:	6/10/2020
County:	Columbia
Nearest Town:	St. Helens
Latitude (decimal degrees):	
Longitude (decimal degrees):	
TRS, quarter/quarter section and tax lot(s):	
Approximate size of the Assessment Area (AA, in acres):	0.28 acres
AA as percent of entire wetland (approx.). Attach sketch map if AA is smaller than the entire contiguous wetland.	100%
If delineated, DSL file number (WD #) if known:	WD2019-0623
Cowardin Systems & Classes (indicate all present, based on field visit and/or aerial imagery): <u>Systems:</u> Palustrine =P, Riverine =R, Lacustrine =L, Estuarine =E <u>Classes:</u> Emergent =EM, Scrub-Shrub =SS, Forested =FO, Aquatic Bed (incl. SAV) =AB, Open Water =OW, Unconsolidated Bottom =UB, Unconsolidated Shore =US	PEMC
Predominant HGM Class: Estuarine=E, Lacustrine=L, Riverine=R, S= Slope, F= Flats, D= Depressional	Depressional/Depressional Outflow
Soil Unit Mapped in Most of the AA:	Rock Outcrop-Xerumbrepts Complex, Undulating
If tidal, the tidal phase during most of visit:	
What percent (approximate) of the wetland were you able to visit?	100%
What percent (approximate) of the AA were you able to visit?	100%
Have you attended an ORWAP training session? If so, indicate approximate month & year.	
How many wetlands have you assessed previously using ORWAP (approximate)?	

Site Name:	Wetlands O through T, QQ, and RR
Investigator Name:	Julie Fox
Date of Field Assessment:	6/10/2020
<i>Scores will appear below after data are entered in worksheets OF, F, T, and S. See Manual for definitions and descriptions of how scores were computed and ratings assigned.</i>	

<i>Normalized Scores & Ratings for this Assessment Area (AA):</i>						
Specific Functions or Values:	Function Score	Function Rating	Rating Break Proximity	Values Score	Values Rating	Rating Break Proximity
Water Storage & Delay (WS)	10.00	Higher		7.50	Higher	
Sediment Retention & Stabilization (SR)	10.00	Higher		6.77	Higher	
Phosphorus Retention (PR)	10.00	Higher		3.55	Moderate	LM
Nitrate Removal & Retention (NR)	10.00	Higher		10.00	Higher	
Anadromous Fish Habitat (FA)	0.00	Lower		0.00	Lower	
Resident Fish Habitat (FR)	0.00	Lower		0.00	Lower	
Amphibian & Reptile Habitat (AM)	7.97	Higher		1.11	Lower	
Waterbird Nesting Habitat (WBN)	0.00	Lower		0.00	Lower	
Waterbird Feeding Habitat (WBF)	0.00	Lower		0.00	Lower	
Aquatic Invertebrate Habitat (INV)	5.74	Moderate		0.67	Lower	
Songbird, Raptor, Mammal Habitat (SBM)	2.76	Lower		2.00	Lower	
Water Cooling (WC)	2.25	Lower	LM	0.00	Lower	
Native Plant Diversity (PD)	6.50	Moderate	MH	10.00	Higher	
Pollinator Habitat (POL)	4.76	Moderate		1.03	Lower	
Organic Nutrient Export (OE)	0.00	Lower				
Carbon Sequestration (CS)	3.22	Lower				
Public Use & Recognition (PU)				1.88	Lower	

Other Attributes:	Score	Rating	Rating Break Proximity
Wetland Sensitivity (SEN)	4.78	Higher	MH
Wetland Ecological Condition (EC)	0.72	Lower	
Wetland Stressors (STR)	5.00	Moderate	

GROUPS	Selected Function	Function Rating	Rating Break Proximity	Values Rating	Rating Break Proximity
Hydrologic Function (WS)	Water Storage & Delay (WS)	Higher		Higher	
Water Quality Support (SR, PR, or NR)	Sediment Retention & Stabilization (SR)	Higher		Higher	
Fish Habitat (FA or FR)	Anadromous Fish Habitat (FA)	Lower		Lower	
Aquatic Habitat (AM, WBF, or WBN)	Amphibian & Reptile Habitat (AM)	Higher		Lower	
Ecosystem Support (WC, INV, PD, POL, SBM, or OE)	Native Plant Diversity (PD)	Moderate	MH	Higher	

ORWAP Version 3.1. Cover Page: Basic Description of Assessment

Site Name:	Wetland U
Investigator Name:	Julie Fox
Date of Field Assessment:	6/10/2020
County:	Columbia
Nearest Town:	St. Helens
Latitude (decimal degrees):	
Longitude (decimal degrees):	
TRS, quarter/quarter section and tax lot(s):	
Approximate size of the Assessment Area (AA, in acres):	0.04 acres
AA as percent of entire wetland (approx.). Attach sketch map if AA is smaller than the entire contiguous wetland.	100%
If delineated, DSL file number (WD #) if known:	WD2019-0623
Cowardin Systems & Classes (indicate all present, based on field visit and/or aerial imagery): <u>Systems:</u> Palustrine =P, Riverine =R, Lacustrine =L, Estuarine =E <u>Classes:</u> Emergent =EM, Scrub-Shrub =SS, Forested =FO, Aquatic Bed (incl. SAV) =AB, Open Water =OW, Unconsolidated Bottom =UB, Unconsolidated Shore =US	PEMC
Predominant HGM Class: Estuarine=E, Lacustrine=L, Riverine=R, S= Slope, F= Flats, D= Depressional	Depressional
Soil Unit Mapped in Most of the AA:	Rock Outcrop-Xerumbrepts Complex, Undulating
If tidal, the tidal phase during most of visit:	
What percent (approximate) of the wetland were you able to visit?	100%
What percent (approximate) of the AA were you able to visit?	100%
Have you attended an ORWAP training session? If so, indicate approximate month & year.	
How many wetlands have you assessed previously using ORWAP (approximate)?	

Site Name:	Wetland U
Investigator Name:	Julie Fox
Date of Field Assessment:	6/10/2020
<i>Scores will appear below after data are entered in worksheets OF, F, T, and S. See Manual for definitions and descriptions of how scores were computed and ratings assigned.</i>	

<i>Normalized Scores & Ratings for this Assessment Area (AA):</i>						
Specific Functions or Values:	Function Score	Function Rating	Rating Break Proximity	Values Score	Values Rating	Rating Break Proximity
Water Storage & Delay (WS)	4.25	Moderate	LM	7.50	Higher	
Sediment Retention & Stabilization (SR)	2.88	Lower		6.77	Higher	
Phosphorus Retention (PR)	2.25	Lower		3.55	Moderate	LM
Nitrate Removal & Retention (NR)	2.11	Lower		10.00	Higher	
Anadromous Fish Habitat (FA)	0.00	Lower		0.00	Lower	
Resident Fish Habitat (FR)	0.00	Lower		0.00	Lower	
Amphibian & Reptile Habitat (AM)	7.89	Higher		1.11	Lower	
Waterbird Nesting Habitat (WBN)	0.00	Lower		0.00	Lower	
Waterbird Feeding Habitat (WBF)	0.00	Lower		0.00	Lower	
Aquatic Invertebrate Habitat (INV)	4.18	Lower	LM	0.66	Lower	
Songbird, Raptor, Mammal Habitat (SBM)	2.63	Lower		2.00	Lower	
Water Cooling (WC)	2.25	Lower	LM	0.61	Lower	
Native Plant Diversity (PD)	6.35	Moderate	MH	10.00	Higher	
Pollinator Habitat (POL)	4.76	Moderate		1.03	Lower	
Organic Nutrient Export (OE)	7.19	Higher	MH			
Carbon Sequestration (CS)	2.75	Lower				
Public Use & Recognition (PU)				1.88	Lower	

Other Attributes:	Score	Rating	Rating Break Proximity
Wetland Sensitivity (SEN)	4.43	Moderate	MH
Wetland Ecological Condition (EC)	0.72	Lower	
Wetland Stressors (STR)	3.33	Lower	LM

GROUPS	Selected Function	Function Rating	Rating Break Proximity	Values Rating	Rating Break Proximity
Hydrologic Function (WS)	Water Storage & Delay (WS)	Moderate	LM	Higher	
Water Quality Support (SR, PR, or NR)	Sediment Retention & Stabilization (SR)	Lower		Higher	
Fish Habitat (FA or FR)	Anadromous Fish Habitat (FA)	Lower		Lower	
Aquatic Habitat (AM, WBF, or WBN)	Amphibian & Reptile Habitat (AM)	Higher		Lower	
Ecosystem Support (WC, INV, PD, POL, SBM, or OE)	Organic Nutrient Export (OE)	Higher	MH	0.00	0.00

ORWAP Version 3.1. Cover Page: Basic Description of Assessment

Site Name:	Wetland Z
Investigator Name:	Julie Fox
Date of Field Assessment:	6/11/2020
County:	Columbia
Nearest Town:	St. Helens
Latitude (decimal degrees):	
Longitude (decimal degrees):	
TRS, quarter/quarter section and tax lot(s):	
Approximate size of the Assessment Area (AA, in acres):	0.15 acres
AA as percent of entire wetland (approx.). Attach sketch map if AA is smaller than the entire contiguous wetland.	100%
If delineated, DSL file number (WD #) if known:	WD2019-0623
Cowardin Systems & Classes (indicate all present, based on field visit and/or aerial imagery): Systems: Palustrine =P, Riverine =R, Lacustrine =L, Estuarine =E Classes: Emergent =EM, Scrub-Shrub =SS, Forested =FO, Aquatic Bed (incl. SAV) =AB, Open Water =OW, Unconsolidated Bottom =UB, Unconsolidated Shore =US	PFOE
Predominant HGM Class: Estuarine=E, Lacustrine=L, Riverine=R, S= Slope, F= Flats, D= Depressional	Depressional
Soil Unit Mapped in Most of the AA:	Rock Outcrop-Xerumbrepts Complex, Undulating
If tidal, the tidal phase during most of visit:	
What percent (approximate) of the wetland were you able to visit?	100%
What percent (approximate) of the AA were you able to visit?	100%
Have you attended an ORWAP training session? If so, indicate approximate month & year.	
How many wetlands have you assessed previously using ORWAP (approximate)?	

Site Name:	Wetland Z
Investigator Name:	Julie Fox
Date of Field Assessment:	6/11/2020
<i>Scores will appear below after data are entered in worksheets OF, F, T, and S. See Manual for definitions and descriptions of how scores were computed and ratings assigned.</i>	

<i>Normalized Scores & Ratings for this Assessment Area (AA):</i>						
Specific Functions or Values:	Function Score	Function Rating	Rating Break Proximity	Values Score	Values Rating	Rating Break Proximity
Water Storage & Delay (WS)	10.00	Higher		7.50	Higher	
Sediment Retention & Stabilization (SR)	10.00	Higher		6.77	Higher	
Phosphorus Retention (PR)	10.00	Higher		3.55	Moderate	LM
Nitrate Removal & Retention (NR)	10.00	Higher		10.00	Higher	
Anadromous Fish Habitat (FA)	0.00	Lower		0.00	Lower	
Resident Fish Habitat (FR)	0.00	Lower		0.00	Lower	
Amphibian & Reptile Habitat (AM)	7.95	Higher		2.39	Lower	
Waterbird Nesting Habitat (WBN)	7.52	Higher		1.72	Moderate	LM
Waterbird Feeding Habitat (WBF)	9.25	Higher		2.08	Lower	LM
Aquatic Invertebrate Habitat (INV)	6.29	Moderate	MH	1.09	Lower	
Songbird, Raptor, Mammal Habitat (SBM)	3.24	Lower	LM	2.00	Lower	
Water Cooling (WC)	3.69	Moderate		0.00	Lower	
Native Plant Diversity (PD)	6.83	Higher	MH	1.49	Lower	
Pollinator Habitat (POL)	4.59	Moderate		1.03	Lower	
Organic Nutrient Export (OE)	0.00	Lower				
Carbon Sequestration (CS)	5.59	Moderate				
Public Use & Recognition (PU)				1.88	Lower	

Other Attributes:	Score	Rating	Rating Break Proximity
Wetland Sensitivity (SEN)	2.11	Lower	LM
Wetland Ecological Condition (EC)	2.99	Moderate	LM
Wetland Stressors (STR)	5.00	Moderate	

GROUPS	Selected Function	Function Rating	Rating Break Proximity	Values Rating	Rating Break Proximity
Hydrologic Function (WS)	Water Storage & Delay (WS)	Higher		Higher	
Water Quality Support (SR, PR, or NR)	Sediment Retention & Stabilization (SR)	Higher		Higher	
Fish Habitat (FA or FR)	Anadromous Fish Habitat (FA)	Lower		Lower	
Aquatic Habitat (AM, WBF, or WBN)	Waterbird Nesting Habitat (WBN)	Higher		Moderate	LM
Ecosystem Support (WC, INV, PD, POL, SBM, or OE)	Native Plant Diversity (PD)	Higher	MH	Lower	

ORWAP Version 3.1. Cover Page: Basic Description of Assessment

Site Name:	Wetland AA
Investigator Name:	Julie Fox
Date of Field Assessment:	6/11/2020
County:	Columbia
Nearest Town:	St. Helens
Latitude (decimal degrees):	
Longitude (decimal degrees):	
TRS, quarter/quarter section and tax lot(s):	
Approximate size of the Assessment Area (AA, in acres):	0.22 acres
AA as percent of entire wetland (approx.). Attach sketch map if AA is smaller than the entire contiguous wetland.	100%
If delineated, DSL file number (WD #) if known:	WD2019-0623
Cowardin Systems & Classes (indicate all present, based on field visit and/or aerial imagery): Systems: Palustrine =P, Riverine =R, Lacustrine =L, Estuarine =E Classes: Emergent =EM, Scrub-Shrub =SS, Forested =FO, Aquatic Bed (incl. SAV) =AB, Open Water =OW, Unconsolidated Bottom =UB, Unconsolidated Shore =US	PFOE
Predominant HGM Class: Estuarine=E, Lacustrine=L, Riverine=R, S= Slope, F= Flats, D= Depressional	Depressional
Soil Unit Mapped in Most of the AA:	Rock Outcrop-Xerumbrepts Complex, Undulating
If tidal, the tidal phase during most of visit:	
What percent (approximate) of the wetland were you able to visit?	100%
What percent (approximate) of the AA were you able to visit?	100%
Have you attended an ORWAP training session? If so, indicate approximate month & year.	
How many wetlands have you assessed previously using ORWAP (approximate)?	

Site Name:	Wetland AA
Investigator Name:	Julie Fox
Date of Field Assessment:	6/11/2020
<i>Scores will appear below after data are entered in worksheets OF, F, T, and S. See Manual for definitions and descriptions of how scores were computed and ratings assigned.</i>	

<i>Normalized Scores & Ratings for this Assessment Area (AA):</i>						
Specific Functions or Values:	Function Score	Function Rating	Rating Break Proximity	Values Score	Values Rating	Rating Break Proximity
Water Storage & Delay (WS)	10.00	Higher		7.50	Higher	
Sediment Retention & Stabilization (SR)	10.00	Higher		6.98	Higher	
Phosphorus Retention (PR)	10.00	Higher		3.72	Moderate	LM
Nitrate Removal & Retention (NR)	10.00	Higher		10.00	Higher	
Anadromous Fish Habitat (FA)	0.00	Lower		0.00	Lower	
Resident Fish Habitat (FR)	0.00	Lower		0.00	Lower	
Amphibian & Reptile Habitat (AM)	7.52	Higher		2.38	Lower	
Waterbird Nesting Habitat (WBN)	7.56	Higher		1.72	Moderate	LM
Waterbird Feeding Habitat (WBF)	9.17	Higher		2.08	Lower	LM
Aquatic Invertebrate Habitat (INV)	7.38	Higher	MH	1.09	Lower	
Songbird, Raptor, Mammal Habitat (SBM)	3.64	Lower	LM	2.00	Lower	
Water Cooling (WC)	8.46	Higher		0.00	Lower	
Native Plant Diversity (PD)	7.74	Higher		1.66	Lower	
Pollinator Habitat (POL)	5.44	Moderate		1.03	Lower	
Organic Nutrient Export (OE)	0.00	Lower				
Carbon Sequestration (CS)	5.93	Moderate	MH			
Public Use & Recognition (PU)				1.88	Lower	

Other Attributes:	Score	Rating	Rating Break Proximity
Wetland Sensitivity (SEN)	2.75	Moderate	LM
Wetland Ecological Condition (EC)	3.53	Moderate	LM
Wetland Stressors (STR)	5.00	Moderate	

GROUPS	Selected Function	Function Rating	Rating Break Proximity	Values Rating	Rating Break Proximity
Hydrologic Function (WS)	Water Storage & Delay (WS)	Higher		Higher	
Water Quality Support (SR, PR, or NR)	Sediment Retention & Stabilization (SR)	Higher		Higher	
Fish Habitat (FA or FR)	Anadromous Fish Habitat (FA)	Lower		Lower	
Aquatic Habitat (AM, WBF, or WBN)	Waterbird Nesting Habitat (WBN)	Higher		Moderate	LM
Ecosystem Support (WC, INV, PD, POL, SBM, or OE)	Aquatic Invertebrate Habitat (INV)	Higher	MH	Lower	

ORWAP Version 3.1. Cover Page: Basic Description of Assessment

Site Name:	Wetland BB
Investigator Name:	Julie Fox
Date of Field Assessment:	6/11/2020
County:	Columbia
Nearest Town:	St. Helens
Latitude (decimal degrees):	
Longitude (decimal degrees):	
TRS, quarter/quarter section and tax lot(s):	
Approximate size of the Assessment Area (AA, in acres):	0.04 acres
AA as percent of entire wetland (approx.). Attach sketch map if AA is smaller than the entire contiguous wetland.	100%
If delineated, DSL file number (WD #) if known:	WD2019-0623
Cowardin Systems & Classes (indicate all present, based on field visit and/or aerial imagery): Systems: Palustrine =P, Riverine =R, Lacustrine =L, Estuarine =E Classes: Emergent =EM, Scrub-Shrub =SS, Forested =FO, Aquatic Bed (incl. SAV) =AB, Open Water =OW, Unconsolidated Bottom =UB, Unconsolidated Shore =US	PFOE
Predominant HGM Class: Estuarine=E, Lacustrine=L, Riverine=R, S= Slope, F= Flats, D= Depressional	Depressional
Soil Unit Mapped in Most of the AA:	Rock Outcrop-Xerumbrepts Complex, Undulating
If tidal, the tidal phase during most of visit:	
What percent (approximate) of the wetland were you able to visit?	100%
What percent (approximate) of the AA were you able to visit?	100%
Have you attended an ORWAP training session? If so, indicate approximate month & year.	
How many wetlands have you assessed previously using ORWAP (approximate)?	

Site Name:	Wetland BB
Investigator Name:	Julie Fox
Date of Field Assessment:	6/11/2020
<i>Scores will appear below after data are entered in worksheets OF, F, T, and S. See Manual for definitions and descriptions of how scores were computed and ratings assigned.</i>	

<i>Normalized Scores & Ratings for this Assessment Area (AA):</i>						
Specific Functions or Values:	Function Score	Function Rating	Rating Break Proximity	Values Score	Values Rating	Rating Break Proximity
Water Storage & Delay (WS)	10.00	Higher		7.50	Higher	
Sediment Retention & Stabilization (SR)	10.00	Higher		6.98	Higher	
Phosphorus Retention (PR)	10.00	Higher		3.72	Moderate	LM
Nitrate Removal & Retention (NR)	10.00	Higher		10.00	Higher	
Anadromous Fish Habitat (FA)	0.00	Lower		0.00	Lower	
Resident Fish Habitat (FR)	0.00	Lower		0.00	Lower	
Amphibian & Reptile Habitat (AM)	7.68	Higher		2.42	Lower	
Waterbird Nesting Habitat (WBN)	8.27	Higher		1.72	Moderate	LM
Waterbird Feeding Habitat (WBF)	9.48	Higher		2.08	Lower	LM
Aquatic Invertebrate Habitat (INV)	8.69	Higher		1.07	Lower	
Songbird, Raptor, Mammal Habitat (SBM)	2.68	Lower		2.00	Lower	
Water Cooling (WC)	8.58	Higher		0.00	Lower	
Native Plant Diversity (PD)	6.88	Higher	MH	1.64	Lower	
Pollinator Habitat (POL)	6.15	Moderate	MH	1.03	Lower	
Organic Nutrient Export (OE)	0.00	Lower				
Carbon Sequestration (CS)	4.90	Moderate				
Public Use & Recognition (PU)				1.88	Lower	

Other Attributes:	Score	Rating	Rating Break Proximity
Wetland Sensitivity (SEN)	2.19	Lower	LM
Wetland Ecological Condition (EC)	2.44	Lower	LM
Wetland Stressors (STR)	5.00	Moderate	

GROUPS	Selected Function	Function Rating	Rating Break Proximity	Values Rating	Rating Break Proximity
Hydrologic Function (WS)	Water Storage & Delay (WS)	Higher		Higher	
Water Quality Support (SR, PR, or NR)	Sediment Retention & Stabilization (SR)	Higher		Higher	
Fish Habitat (FA or FR)	Anadromous Fish Habitat (FA)	Lower		Lower	
Aquatic Habitat (AM, WBF, or WBN)	Waterbird Nesting Habitat (WBN)	Higher		Moderate	LM
Ecosystem Support (WC, INV, PD, POL, SBM, or OE)	Aquatic Invertebrate Habitat (INV)	Higher		Lower	

ORWAP Version 3.1. Cover Page: Basic Description of Assessment

Site Name:	Wetland CC
Investigator Name:	Julie Fox
Date of Field Assessment:	6/11/2020
County:	Columbia
Nearest Town:	St. Helens
Latitude (decimal degrees):	
Longitude (decimal degrees):	
TRS, quarter/quarter section and tax lot(s):	
Approximate size of the Assessment Area (AA, in acres):	0.25 acres
AA as percent of entire wetland (approx.). Attach sketch map if AA is smaller than the entire contiguous wetland.	100%
If delineated, DSL file number (WD #) if known:	WD2019-0623
Cowardin Systems & Classes (indicate all present, based on field visit and/or aerial imagery): Systems: Palustrine =P, Riverine =R, Lacustrine =L, Estuarine =E Classes: Emergent =EM, Scrub-Shrub =SS, Forested =FO, Aquatic Bed (incl. SAV) =AB, Open Water =OW, Unconsolidated Bottom =UB, Unconsolidated Shore =US	PFOE
Predominant HGM Class: Estuarine=E, Lacustrine=L, Riverine=R, S= Slope, F= Flats, D= Depressional	Depressional
Soil Unit Mapped in Most of the AA:	Rock Outcrop-Xerumbrepts Complex, Undulating
If tidal, the tidal phase during most of visit:	
What percent (approximate) of the wetland were you able to visit?	100%
What percent (approximate) of the AA were you able to visit?	100%
Have you attended an ORWAP training session? If so, indicate approximate month & year.	
How many wetlands have you assessed previously using ORWAP (approximate)?	

Site Name:	Wetland CC
Investigator Name:	Julie Fox
Date of Field Assessment:	6/11/2020
<i>Scores will appear below after data are entered in worksheets OF, F, T, and S. See Manual for definitions and descriptions of how scores were computed and ratings assigned.</i>	

<i>Normalized Scores & Ratings for this Assessment Area (AA):</i>						
Specific Functions or Values:	Function Score	Function Rating	Rating Break Proximity	Values Score	Values Rating	Rating Break Proximity
Water Storage & Delay (WS)	10.00	Higher		7.50	Higher	
Sediment Retention & Stabilization (SR)	10.00	Higher		6.98	Higher	
Phosphorus Retention (PR)	10.00	Higher		3.72	Moderate	LM
Nitrate Removal & Retention (NR)	10.00	Higher		10.00	Higher	
Anadromous Fish Habitat (FA)	0.00	Lower		0.00	Lower	
Resident Fish Habitat (FR)	0.00	Lower		0.00	Lower	
Amphibian & Reptile Habitat (AM)	7.91	Higher		2.43	Lower	
Waterbird Nesting Habitat (WBN)	7.97	Higher		1.72	Moderate	LM
Waterbird Feeding Habitat (WBF)	9.53	Higher		2.08	Lower	LM
Aquatic Invertebrate Habitat (INV)	8.24	Higher		1.11	Lower	
Songbird, Raptor, Mammal Habitat (SBM)	3.48	Lower	LM	2.00	Lower	
Water Cooling (WC)	8.37	Higher		0.00	Lower	
Native Plant Diversity (PD)	8.02	Higher		1.66	Lower	
Pollinator Habitat (POL)	5.61	Moderate		1.03	Lower	
Organic Nutrient Export (OE)	0.00	Lower				
Carbon Sequestration (CS)	4.75	Moderate				
Public Use & Recognition (PU)				1.81	Lower	

Other Attributes:	Score	Rating	Rating Break Proximity
Wetland Sensitivity (SEN)	2.90	Moderate	
Wetland Ecological Condition (EC)	2.74	Lower	LM
Wetland Stressors (STR)	5.00	Moderate	

GROUPS	Selected Function	Function Rating	Rating Break Proximity	Values Rating	Rating Break Proximity
Hydrologic Function (WS)	Water Storage & Delay (WS)	Higher		Higher	
Water Quality Support (SR, PR, or NR)	Sediment Retention & Stabilization (SR)	Higher		Higher	
Fish Habitat (FA or FR)	Anadromous Fish Habitat (FA)	Lower		Lower	
Aquatic Habitat (AM, WBF, or WBN)	Waterbird Nesting Habitat (WBN)	Higher		Moderate	LM
Ecosystem Support (WC, INV, PD, POL, SBM, or OE)	Aquatic Invertebrate Habitat (INV)	Higher		Lower	

ORWAP Version 3.1. Cover Page: Basic Description of Assessment

Site Name:	Wetland DD
Investigator Name:	Julie Fox
Date of Field Assessment:	6/11/2020
County:	Columbia
Nearest Town:	St. Helens
Latitude (decimal degrees):	
Longitude (decimal degrees):	
TRS, quarter/quarter section and tax lot(s):	
Approximate size of the Assessment Area (AA, in acres):	0.10 acres
AA as percent of entire wetland (approx.). Attach sketch map if AA is smaller than the entire contiguous wetland.	100%
If delineated, DSL file number (WD #) if known:	WD2019-0623
Cowardin Systems & Classes (indicate all present, based on field visit and/or aerial imagery): Systems: Palustrine =P, Riverine =R, Lacustrine =L, Estuarine =E Classes: Emergent =EM, Scrub-Shrub =SS, Forested =FO, Aquatic Bed (incl. SAV) =AB, Open Water =OW, Unconsolidated Bottom =UB, Unconsolidated Shore =US	PFOE
Predominant HGM Class: Estuarine=E, Lacustrine=L, Riverine=R, S= Slope, F= Flats, D= Depressional	Depressional
Soil Unit Mapped in Most of the AA:	Rock Outcrop-Xerumbrepts Complex, Undulating
If tidal, the tidal phase during most of visit:	
What percent (approximate) of the wetland were you able to visit?	100%
What percent (approximate) of the AA were you able to visit?	100%
Have you attended an ORWAP training session? If so, indicate approximate month & year.	
How many wetlands have you assessed previously using ORWAP (approximate)?	

Site Name:	Wetland DD
Investigator Name:	Julie Fox
Date of Field Assessment:	6/11/2020
<i>Scores will appear below after data are entered in worksheets OF, F, T, and S. See Manual for definitions and descriptions of how scores were computed and ratings assigned.</i>	

<i>Normalized Scores & Ratings for this Assessment Area (AA):</i>						
Specific Functions or Values:	Function Score	Function Rating	Rating Break Proximity	Values Score	Values Rating	Rating Break Proximity
Water Storage & Delay (WS)	10.00	Higher		7.50	Higher	
Sediment Retention & Stabilization (SR)	10.00	Higher		6.98	Higher	
Phosphorus Retention (PR)	10.00	Higher		3.72	Moderate	LM
Nitrate Removal & Retention (NR)	10.00	Higher		10.00	Higher	
Anadromous Fish Habitat (FA)	0.00	Lower		0.00	Lower	
Resident Fish Habitat (FR)	0.00	Lower		0.00	Lower	
Amphibian & Reptile Habitat (AM)	7.57	Higher		2.38	Lower	
Waterbird Nesting Habitat (WBN)	7.81	Higher		1.72	Moderate	LM
Waterbird Feeding Habitat (WBF)	9.16	Higher		2.08	Lower	LM
Aquatic Invertebrate Habitat (INV)	7.85	Higher		1.09	Lower	
Songbird, Raptor, Mammal Habitat (SBM)	3.73	Moderate	LM	2.00	Lower	
Water Cooling (WC)	8.00	Higher		0.00	Lower	
Native Plant Diversity (PD)	7.21	Higher	MH	1.72	Lower	
Pollinator Habitat (POL)	5.81	Moderate		1.03	Lower	
Organic Nutrient Export (OE)	0.00	Lower				
Carbon Sequestration (CS)	4.71	Moderate				
Public Use & Recognition (PU)				1.88	Lower	

Other Attributes:	Score	Rating	Rating Break Proximity
Wetland Sensitivity (SEN)	2.02	Lower	LM
Wetland Ecological Condition (EC)	3.04	Moderate	LM
Wetland Stressors (STR)	5.00	Moderate	

GROUPS	Selected Function	Function Rating	Rating Break Proximity	Values Rating	Rating Break Proximity
Hydrologic Function (WS)	Water Storage & Delay (WS)	Higher		Higher	
Water Quality Support (SR, PR, or NR)	Sediment Retention & Stabilization (SR)	Higher		Higher	
Fish Habitat (FA or FR)	Anadromous Fish Habitat (FA)	Lower		Lower	
Aquatic Habitat (AM, WBF, or WBN)	Waterbird Nesting Habitat (WBN)	Higher		Moderate	LM
Ecosystem Support (WC, INV, PD, POL, SBM, or OE)	Aquatic Invertebrate Habitat (INV)	Higher		Lower	

ORWAP Version 3.1. Cover Page: Basic Description of Assessment

Site Name:	Wetlands EE and FF
Investigator Name:	Julie Fox
Date of Field Assessment:	6/11/2020
County:	Columbia
Nearest Town:	St. Helens
Latitude (decimal degrees):	
Longitude (decimal degrees):	
TRS, quarter/quarter section and tax lot(s):	
Approximate size of the Assessment Area (AA, in acres):	0.65 acres
AA as percent of entire wetland (approx.). Attach sketch map if AA is smaller than the entire contiguous wetland.	100%
If delineated, DSL file number (WD #) if known:	WD2019-0623
Cowardin Systems & Classes (indicate all present, based on field visit and/or aerial imagery): Systems: Palustrine =P, Riverine =R, Lacustrine =L, Estuarine =E Classes: Emergent =EM, Scrub-Shrub =SS, Forested =FO, Aquatic Bed (incl. SAV) =AB, Open Water =OW, Unconsolidated Bottom =UB, Unconsolidated Shore =US	PFOE
Predominant HGM Class: Estuarine=E, Lacustrine=L, Riverine=R, S= Slope, F= Flats, D= Depressional	Depressional
Soil Unit Mapped in Most of the AA:	Rock Outcrop-Xerumbrepts Complex, Undulating
If tidal, the tidal phase during most of visit:	
What percent (approximate) of the wetland were you able to visit?	100%
What percent (approximate) of the AA were you able to visit?	100%
Have you attended an ORWAP training session? If so, indicate approximate month & year.	
How many wetlands have you assessed previously using ORWAP (approximate)?	

Site Name:	Wetlands EE and FF
Investigator Name:	Julie Fox
Date of Field Assessment:	6/11/2020
<i>Scores will appear below after data are entered in worksheets OF, F, T, and S. See Manual for definitions and descriptions of how scores were computed and ratings assigned.</i>	

<i>Normalized Scores & Ratings for this Assessment Area (AA):</i>						
Specific Functions or Values:	Function Score	Function Rating	Rating Break Proximity	Values Score	Values Rating	Rating Break Proximity
Water Storage & Delay (WS)	10.00	Higher		7.50	Higher	
Sediment Retention & Stabilization (SR)	10.00	Higher		6.98	Higher	
Phosphorus Retention (PR)	10.00	Higher		3.72	Moderate	LM
Nitrate Removal & Retention (NR)	10.00	Higher		10.00	Higher	
Anadromous Fish Habitat (FA)	0.00	Lower		0.00	Lower	
Resident Fish Habitat (FR)	0.00	Lower		0.00	Lower	
Amphibian & Reptile Habitat (AM)	7.61	Higher		2.41	Lower	
Waterbird Nesting Habitat (WBN)	7.99	Higher		1.72	Moderate	LM
Waterbird Feeding Habitat (WBF)	9.40	Higher		2.08	Lower	LM
Aquatic Invertebrate Habitat (INV)	6.71	Moderate	MH	1.08	Lower	
Songbird, Raptor, Mammal Habitat (SBM)	3.22	Lower	LM	2.00	Lower	
Water Cooling (WC)	9.83	Higher		0.00	Lower	
Native Plant Diversity (PD)	7.25	Higher	MH	1.68	Lower	
Pollinator Habitat (POL)	5.93	Moderate		1.03	Lower	
Organic Nutrient Export (OE)	0.00	Lower				
Carbon Sequestration (CS)	4.98	Moderate				
Public Use & Recognition (PU)				1.88	Lower	

Other Attributes:	Score	Rating	Rating Break Proximity
Wetland Sensitivity (SEN)	2.27	Moderate	LM
Wetland Ecological Condition (EC)	1.46	Lower	
Wetland Stressors (STR)	5.00	Moderate	

GROUPS	Selected Function	Function Rating	Rating Break Proximity	Values Rating	Rating Break Proximity
Hydrologic Function (WS)	Water Storage & Delay (WS)	Higher		Higher	
Water Quality Support (SR, PR, or NR)	Sediment Retention & Stabilization (SR)	Higher		Higher	
Fish Habitat (FA or FR)	Anadromous Fish Habitat (FA)	Lower		Lower	
Aquatic Habitat (AM, WBF, or WBN)	Waterbird Nesting Habitat (WBN)	Higher		Moderate	LM
Ecosystem Support (WC, INV, PD, POL, SBM, or OE)	Water Cooling (WC)	Higher		Lower	

ORWAP Version 3.1. Cover Page: Basic Description of Assessment

Site Name:	Wetland PP
Investigator Name:	Julie Fox
Date of Field Assessment:	6/10/2020
County:	Columbia
Nearest Town:	St. Helens
Latitude (decimal degrees):	
Longitude (decimal degrees):	
TRS, quarter/quarter section and tax lot(s):	
Approximate size of the Assessment Area (AA, in acres):	0.01 acre
AA as percent of entire wetland (approx.). Attach sketch map if AA is smaller than the entire contiguous wetland.	100%
If delineated, DSL file number (WD #) if known:	WD2019-0623
Cowardin Systems & Classes (indicate all present, based on field visit and/or aerial imagery): <u>Systems:</u> Palustrine =P, Riverine =R, Lacustrine =L, Estuarine =E <u>Classes:</u> Emergent =EM, Scrub-Shrub =SS, Forested =FO, Aquatic Bed (incl. SAV) =AB, Open Water =OW, Unconsolidated Bottom =UB, Unconsolidated Shore =US	PEMC
Predominant HGM Class: Estuarine=E, Lacustrine=L, Riverine=R, S= Slope, F= Flats, D= Depressional	Depressional Outflow
Soil Unit Mapped in Most of the AA:	Rock Outcrop-Xerumbrepts Complex, Undulating
If tidal, the tidal phase during most of visit:	
What percent (approximate) of the wetland were you able to visit?	100%
What percent (approximate) of the AA were you able to visit?	100%
Have you attended an ORWAP training session? If so, indicate approximate month & year.	
How many wetlands have you assessed previously using ORWAP (approximate)?	

Site Name:	Wetland PP
Investigator Name:	Julie Fox
Date of Field Assessment:	6/10/2020
<i>Scores will appear below after data are entered in worksheets OF, F, T, and S. See Manual for definitions and descriptions of how scores were computed and ratings assigned.</i>	

<i>Normalized Scores & Ratings for this Assessment Area (AA):</i>						
Specific Functions or Values:	Function Score	Function Rating	Rating Break Proximity	Values Score	Values Rating	Rating Break Proximity
Water Storage & Delay (WS)	4.37	Moderate	LM	7.50	Higher	
Sediment Retention & Stabilization (SR)	3.11	Lower	LM	7.50	Higher	
Phosphorus Retention (PR)	2.46	Lower	LM	4.64	Moderate	
Nitrate Removal & Retention (NR)	2.30	Lower		10.00	Higher	
Anadromous Fish Habitat (FA)	0.00	Lower		0.00	Lower	
Resident Fish Habitat (FR)	0.00	Lower		0.00	Lower	
Amphibian & Reptile Habitat (AM)	7.89	Higher		1.11	Lower	
Waterbird Nesting Habitat (WBN)	0.00	Lower		0.00	Lower	
Waterbird Feeding Habitat (WBF)	0.00	Lower		0.00	Lower	
Aquatic Invertebrate Habitat (INV)	7.83	Higher		0.66	Lower	
Songbird, Raptor, Mammal Habitat (SBM)	2.63	Lower		2.00	Lower	
Water Cooling (WC)	2.25	Lower	LM	0.74	Lower	
Native Plant Diversity (PD)	6.66	Higher	MH	10.00	Higher	
Pollinator Habitat (POL)	4.76	Moderate		1.03	Lower	
Organic Nutrient Export (OE)	7.47	Higher				
Carbon Sequestration (CS)	2.75	Lower				
Public Use & Recognition (PU)				1.88	Lower	

Other Attributes:	Score	Rating	Rating Break Proximity
Wetland Sensitivity (SEN)	4.43	Moderate	MH
Wetland Ecological Condition (EC)	0.72	Lower	
Wetland Stressors (STR)	3.33	Lower	LM

GROUPS	Selected Function	Function Rating	Rating Break Proximity	Values Rating	Rating Break Proximity
Hydrologic Function (WS)	Water Storage & Delay (WS)	Moderate	LM	Higher	
Water Quality Support (SR, PR, or NR)	Sediment Retention & Stabilization (SR)	Lower	LM	Higher	
Fish Habitat (FA or FR)	Anadromous Fish Habitat (FA)	Lower		Lower	
Aquatic Habitat (AM, WBF, or WBN)	Amphibian & Reptile Habitat (AM)	Higher		Lower	
Ecosystem Support (WC, INV, PD, POL, SBM, or OE)	Native Plant Diversity (PD)	Higher	MH	Higher	

ORWAP Version 3.1. Cover Page: Basic Description of Assessment

Site Name:	Wetland YY
Investigator Name:	Julie Fox
Date of Field Assessment:	6/11/2020
County:	Columbia
Nearest Town:	St. Helens
Latitude (decimal degrees):	
Longitude (decimal degrees):	
TRS, quarter/quarter section and tax lot(s):	
Approximate size of the Assessment Area (AA, in acres):	0.02 acres
AA as percent of entire wetland (approx.). Attach sketch map if AA is smaller than the entire contiguous wetland.	100%
If delineated, DSL file number (WD #) if known:	WD2019-0623
Cowardin Systems & Classes (indicate all present, based on field visit and/or aerial imagery): Systems: Palustrine =P, Riverine =R, Lacustrine =L, Estuarine =E Classes: Emergent =EM, Scrub-Shrub =SS, Forested =FO, Aquatic Bed (incl. SAV) =AB, Open Water =OW, Unconsolidated Bottom =UB, Unconsolidated Shore =US	PFOE
Predominant HGM Class: Estuarine=E, Lacustrine=L, Riverine=R, S= Slope, F= Flats, D= Depressional	Depressional
Soil Unit Mapped in Most of the AA:	Rock Outcrop-Xerumbrepts Complex, Undulating
If tidal, the tidal phase during most of visit:	
What percent (approximate) of the wetland were you able to visit?	100%
What percent (approximate) of the AA were you able to visit?	100%
Have you attended an ORWAP training session? If so, indicate approximate month & year.	
How many wetlands have you assessed previously using ORWAP (approximate)?	

Site Name:	Wetland YY
Investigator Name:	Julie Fox
Date of Field Assessment:	6/11/2020
<i>Scores will appear below after data are entered in worksheets OF, F, T, and S. See Manual for definitions and descriptions of how scores were computed and ratings assigned.</i>	

<i>Normalized Scores & Ratings for this Assessment Area (AA):</i>						
Specific Functions or Values:	Function Score	Function Rating	Rating Break Proximity	Values Score	Values Rating	Rating Break Proximity
Water Storage & Delay (WS)	4.41	Moderate	LM	7.50	Higher	
Sediment Retention & Stabilization (SR)	3.10	Lower	LM	6.98	Higher	
Phosphorus Retention (PR)	2.72	Lower	LM	3.72	Moderate	LM
Nitrate Removal & Retention (NR)	3.31	Lower	LM	10.00	Higher	
Anadromous Fish Habitat (FA)	0.00	Lower		0.00	Lower	
Resident Fish Habitat (FR)	0.00	Lower		0.00	Lower	
Amphibian & Reptile Habitat (AM)	7.80	Higher		2.38	Lower	
Waterbird Nesting Habitat (WBN)	7.87	Higher		1.72	Moderate	LM
Waterbird Feeding Habitat (WBF)	9.19	Higher		2.08	Lower	LM
Aquatic Invertebrate Habitat (INV)	4.93	Moderate	LM	1.08	Lower	
Songbird, Raptor, Mammal Habitat (SBM)	3.18	Lower	LM	2.00	Lower	
Water Cooling (WC)	2.25	Lower	LM	0.55	Lower	
Native Plant Diversity (PD)	0.00	Lower		0.00	Lower	
Pollinator Habitat (POL)	5.76	Moderate		1.03	Lower	
Organic Nutrient Export (OE)	5.66	Moderate				
Carbon Sequestration (CS)	2.89	Lower				
Public Use & Recognition (PU)				1.88	Lower	

Other Attributes:	Score	Rating	Rating Break Proximity
Wetland Sensitivity (SEN)	0.30	Lower	
Wetland Ecological Condition (EC)	2.25	Lower	
Wetland Stressors (STR)	3.33	Lower	LM

GROUPS	Selected Function	Function Rating	Rating Break Proximity	Values Rating	Rating Break Proximity
Hydrologic Function (WS)	Water Storage & Delay (WS)	Moderate	LM	Higher	
Water Quality Support (SR, PR, or NR)	Sediment Retention & Stabilization (SR)	Lower	LM	Higher	
Fish Habitat (FA or FR)	Anadromous Fish Habitat (FA)	Lower		Lower	
Aquatic Habitat (AM, WBF, or WBN)	Waterbird Nesting Habitat (WBN)	Higher		Moderate	LM
Ecosystem Support (WC, INV, PD, POL, SBM, or OE)	Organic Nutrient Export (OE)	Moderate		0.00	0.00

ORWAP Version 3.1. Cover Page: Basic Description of Assessment

Site Name:	Wetland ZZ
Investigator Name:	Julie Fox
Date of Field Assessment:	6/11/2020
County:	Columbia
Nearest Town:	St. Helens
Latitude (decimal degrees):	
Longitude (decimal degrees):	
TRS, quarter/quarter section and tax lot(s):	
Approximate size of the Assessment Area (AA, in acres):	0.05 acres
AA as percent of entire wetland (approx.). Attach sketch map if AA is smaller than the entire contiguous wetland.	100%
If delineated, DSL file number (WD #) if known:	WD2019-0623
Cowardin Systems & Classes (indicate all present, based on field visit and/or aerial imagery): Systems: Palustrine =P, Riverine =R, Lacustrine =L, Estuarine =E Classes: Emergent =EM, Scrub-Shrub =SS, Forested =FO, Aquatic Bed (incl. SAV) =AB, Open Water =OW, Unconsolidated Bottom =UB, Unconsolidated Shore =US	PFOE
Predominant HGM Class: Estuarine=E, Lacustrine=L, Riverine=R, S= Slope, F= Flats, D= Depressional	Depressional
Soil Unit Mapped in Most of the AA:	Rock Outcrop-Xerumbrepts Complex, Undulating
If tidal, the tidal phase during most of visit:	
What percent (approximate) of the wetland were you able to visit?	100%
What percent (approximate) of the AA were you able to visit?	100%
Have you attended an ORWAP training session? If so, indicate approximate month & year.	
How many wetlands have you assessed previously using ORWAP (approximate)?	

Site Name:	Wetland ZZ
Investigator Name:	Julie Fox
Date of Field Assessment:	6/11/2020
<i>Scores will appear below after data are entered in worksheets OF, F, T, and S. See Manual for definitions and descriptions of how scores were computed and ratings assigned.</i>	

<i>Normalized Scores & Ratings for this Assessment Area (AA):</i>						
Specific Functions or Values:	Function Score	Function Rating	Rating Break Proximity	Values Score	Values Rating	Rating Break Proximity
Water Storage & Delay (WS)	10.00	Higher		7.50	Higher	
Sediment Retention & Stabilization (SR)	10.00	Higher		6.98	Higher	
Phosphorus Retention (PR)	10.00	Higher		3.72	Moderate	LM
Nitrate Removal & Retention (NR)	10.00	Higher		10.00	Higher	
Anadromous Fish Habitat (FA)	0.00	Lower		0.00	Lower	
Resident Fish Habitat (FR)	0.00	Lower		0.00	Lower	
Amphibian & Reptile Habitat (AM)	7.60	Higher		2.38	Lower	
Waterbird Nesting Habitat (WBN)	7.32	Higher	MH	1.72	Moderate	LM
Waterbird Feeding Habitat (WBF)	9.21	Higher		2.08	Lower	LM
Aquatic Invertebrate Habitat (INV)	7.39	Higher	MH	1.06	Lower	
Songbird, Raptor, Mammal Habitat (SBM)	2.93	Lower		2.00	Lower	
Water Cooling (WC)	8.96	Higher		0.00	Lower	
Native Plant Diversity (PD)	7.30	Higher	MH	1.63	Lower	
Pollinator Habitat (POL)	5.83	Moderate		1.03	Lower	
Organic Nutrient Export (OE)	0.00	Lower				
Carbon Sequestration (CS)	4.47	Moderate				
Public Use & Recognition (PU)				1.88	Lower	

Other Attributes:	Score	Rating	Rating Break Proximity
Wetland Sensitivity (SEN)	2.67	Moderate	LM
Wetland Ecological Condition (EC)	2.94	Moderate	LM
Wetland Stressors (STR)	5.00	Moderate	

GROUPS	Selected Function	Function Rating	Rating Break Proximity	Values Rating	Rating Break Proximity
Hydrologic Function (WS)	Water Storage & Delay (WS)	Higher		Higher	
Water Quality Support (SR, PR, or NR)	Sediment Retention & Stabilization (SR)	Higher		Higher	
Fish Habitat (FA or FR)	Anadromous Fish Habitat (FA)	Lower		Lower	
Aquatic Habitat (AM, WBF, or WBN)	Waterbird Nesting Habitat (WBN)	Higher	MH	Moderate	LM
Ecosystem Support (WC, INV, PD, POL, SBM, or OE)	Aquatic Invertebrate Habitat (INV)	Higher	MH	Lower	

ORWAP Version 3.1. Cover Page: Basic Description of Assessment

Site Name:	Wetland OO
Investigator Name:	Julie Fox
Date of Field Assessment:	6/10/2020
County:	Columbia
Nearest Town:	St. Helens
Latitude (decimal degrees):	
Longitude (decimal degrees):	
TRS, quarter/quarter section and tax lot(s):	
Approximate size of the Assessment Area (AA, in acres):	0.1 acre
AA as percent of entire wetland (approx.). Attach sketch map if AA is smaller than the entire contiguous wetland.	100%
If delineated, DSL file number (WD #) if known:	WD2019-0623
Cowardin Systems & Classes (indicate all present, based on field visit and/or aerial imagery): <u>Systems:</u> Palustrine =P, Riverine =R, Lacustrine =L, Estuarine =E <u>Classes:</u> Emergent =EM, Scrub-Shrub =SS, Forested =FO, Aquatic Bed (incl. SAV) =AB, Open Water =OW, Unconsolidated Bottom =UB, Unconsolidated Shore =US	PEMC
Predominant HGM Class: Estuarine=E, Lacustrine=L, Riverine=R, S= Slope, F= Flats, D= Depressional	Depressional Outflow
Soil Unit Mapped in Most of the AA:	Rock Outcrop-Xerumbrepts Complex, Undulating
If tidal, the tidal phase during most of visit:	
What percent (approximate) of the wetland were you able to visit?	100%
What percent (approximate) of the AA were you able to visit?	100%
Have you attended an ORWAP training session? If so, indicate approximate month & year.	
How many wetlands have you assessed previously using ORWAP (approximate)?	

Site Name:	Wetland OO
Investigator Name:	Julie Fox
Date of Field Assessment:	6/10/2020
<i>Scores will appear below after data are entered in worksheets OF, F, T, and S. See Manual for definitions and descriptions of how scores were computed and ratings assigned.</i>	

<i>Normalized Scores & Ratings for this Assessment Area (AA):</i>						
Specific Functions or Values:	Function Score	Function Rating	Rating Break Proximity	Values Score	Values Rating	Rating Break Proximity
Water Storage & Delay (WS)	4.33	Moderate	LM	7.50	Higher	
Sediment Retention & Stabilization (SR)	3.07	Lower	LM	6.77	Higher	
Phosphorus Retention (PR)	2.41	Lower	LM	3.55	Moderate	LM
Nitrate Removal & Retention (NR)	2.96	Lower		10.00	Higher	
Anadromous Fish Habitat (FA)	0.00	Lower		0.00	Lower	
Resident Fish Habitat (FR)	0.00	Lower		0.00	Lower	
Amphibian & Reptile Habitat (AM)	8.01	Higher		2.38	Lower	
Waterbird Nesting Habitat (WBN)	7.79	Higher		1.72	Moderate	LM
Waterbird Feeding Habitat (WBF)	9.18	Higher		2.08	Lower	LM
Aquatic Invertebrate Habitat (INV)	4.71	Moderate	LM	1.08	Lower	
Songbird, Raptor, Mammal Habitat (SBM)	2.93	Lower		2.00	Lower	
Water Cooling (WC)	2.38	Lower	LM	0.61	Lower	
Native Plant Diversity (PD)	0.00	Lower		0.00	Lower	
Pollinator Habitat (POL)	5.11	Moderate		1.03	Lower	
Organic Nutrient Export (OE)	6.12	Moderate				
Carbon Sequestration (CS)	2.95	Lower				
Public Use & Recognition (PU)				1.88	Lower	

Other Attributes:	Score	Rating	Rating Break Proximity
Wetland Sensitivity (SEN)	4.33	Moderate	MH
Wetland Ecological Condition (EC)	1.51	Lower	
Wetland Stressors (STR)	3.33	Lower	LM

GROUPS	Selected Function	Function Rating	Rating Break Proximity	Values Rating	Rating Break Proximity
Hydrologic Function (WS)	Water Storage & Delay (WS)	Moderate	LM	Higher	
Water Quality Support (SR, PR, or NR)	Sediment Retention & Stabilization (SR)	Lower	LM	Higher	
Fish Habitat (FA or FR)	Anadromous Fish Habitat (FA)	Lower		Lower	
Aquatic Habitat (AM, WBF, or WBN)	Waterbird Nesting Habitat (WBN)	Higher		Moderate	LM
Ecosystem Support (WC, INV, PD, POL, SBM, or OE)	Organic Nutrient Export (OE)	Moderate		0.00	0.00

Appendix B

Pre-Project ORWAP Report

Report Generated: July 10, 2022 12:09 PM

Assessment Area: 169.9 Acres

Location Map



Location Information

Latitude	45.8713433139426	Longitude	-122.823254593932
Elevation	239 ft	Annual precipitation	46 in
Watershed (HUC12)	Deer Island Slough-Frontal Columbia River (170800030401)		
Presettlement Vegetation Class	Oak-Douglas fir		
Rare Wetland Type(s)	None		
Hydrologic Landscape Class	Wet		
In Special Protected Area?	No		

[View Salinity Maps \(pdf\)](#)

Soil Information

Soil Name	Rock outcrop-Xerumbrepts complex, undulating
Soil Symbol	45
Hydric Rating	No
Hydric Percent	0
Percent Area	85.2%
Erosion Hazard	Not rated

Dom. Cond. Non-irrigated Capability Class	Class 8 soils and miscellaneous areas have limitations that preclude commercial plant production and that restrict their use to recreational purposes, wildlife habitat, watershed, or esthetic purposes.
---	---

Soil Name	Cornelius silt loam, 15 to 30 percent slopes
Soil Symbol	14D
Hydric Rating	No
Hydric Percent	0
Percent Area	6.7%
Erosion Hazard	Severe
Dom. Cond. Non-irrigated Capability Class	Class 4 soils have very severe limitations that reduce the choice of plants or that require very careful management, or both.

Soil Name	Cornelius silt loam, 8 to 15 percent slopes
Soil Symbol	14C
Hydric Rating	No
Hydric Percent	0
Percent Area	2.8%
Erosion Hazard	Severe
Dom. Cond. Non-irrigated Capability Class	Class 3 soils have severe limitations that reduce the choice of plants or that require special conservation practices, or both.

Soil Name	Bacona silt loam, 3 to 30 percent slopes
Soil Symbol	6D
Hydric Rating	No
Hydric Percent	3
Percent Area	1.9%
Erosion Hazard	Severe
Dom. Cond. Non-irrigated Capability Class	Class 6 soils have severe limitations that make them generally unsuitable for cultivation and that restrict their use mainly to pasture, rangeland, forestland, or wildlife habitat.

Soil Name	Cascade silt loam, 8 to 15 percent slopes
Soil Symbol	10C
Hydric Rating	No

Hydric Percent	4
Percent Area	1.6%
Erosion Hazard	Severe
Dom. Cond. Non-irrigated Capability Class	Class 3 soils have severe limitations that reduce the choice of plants or that require special conservation practices, or both.

Soil Name	Bacona silt loam, 3 to 30 percent slopes
Soil Symbol	6D
Hydric Rating	No
Hydric Percent	3
Percent Area	1.1%
Erosion Hazard	Severe
Dom. Cond. Non-irrigated Capability Class	Class 6 soils have severe limitations that make them generally unsuitable for cultivation and that restrict their use mainly to pasture, rangeland, forestland, or wildlife habitat.

Soil Name	Dowde silt loam, 30 to 60 percent south slopes
Soil Symbol	19E
Hydric Rating	No
Hydric Percent	0
Percent Area	0.7%
Erosion Hazard	Severe
Dom. Cond. Non-irrigated Capability Class	Class 6 soils have severe limitations that make them generally unsuitable for cultivation and that restrict their use mainly to pasture, rangeland, forestland, or wildlife habitat.

Soil Name	Dowde silt loam, 30 to 60 percent south slopes
Soil Symbol	19E
Hydric Rating	No
Hydric Percent	0
Percent Area	0%
Erosion Hazard	Severe
Dom. Cond. Non-irrigated Capability Class	Class 6 soils have severe limitations that make them generally unsuitable for cultivation and that restrict their use mainly to pasture, rangeland, forestland, or wildlife habitat.

Watershed Information

HUC Best

HUC Code	HUC Name	Is HUC Best?	Greatest Criteria met	FW, s/f, lg (Acres)	FW, em, lg (Acres)	EST, em, lg (Acres)	EST, s/f, lg (Acres)
HUC8: 17080003	Lower Columbia-Clatskanie	Yes	proportional	330.6	784.6	57.6	0
HUC10: 1708000304	n/a	No	n/a	n/a	n/a	n/a	n/a
HUC12: 170800030401	Deer Island Slough-Frontal Columbia River	No	n/a	n/a	n/a	n/a	n/a

[abbreviations: FW- freshwater (wetland); em- Emergent; lg- largest; s/f- Shrub/Forested; EST- Estuarine (wetland)]

HUC 12 Functional Deficit

HUC Code	HUC Name	WS	SR	NT	WC	INV	AM	FH	WB
HUC12: 170800030401	Deer Island Slough-Frontal Columbia River								

[abbreviations: WS= Water Storage, SR= Sediment Retention, NT= Nutrient Retention (PR or NR), WC= Water Cooling (Thermoregulation), INV= Invertebrate Habitat, AM= Amphibian Habitat, FH= Fish Habitat (FA or FR), WB= Waterbird Habitat (WBF or WBN)]

Rare Species Scores

Rare Species Type	Maximum score	Sum Score	Rating
Non-anadromous Fish Species	0	0	None
Amphibian & Reptile Species	0	0	None
Feeding Waterbirds	0	0	None
Nesting Waterbirds	0	0	None
Songbirds, Raptors, and Mammals	0	0	None
Invertebrate Species	0	0	None
Plant Species	0	0	None

Scores have taken into account several factors for each rare species record contained in the official database of the Oregon Biodiversity Information Center (ORBIC): (a) the regional rarity of the species, (b) their proximity to the point of interest, and (c) the “certainty” that ORBIC assigns to each of those records.

Element of Occurrence (Rare Species)

[View wildlife list for Deer Island Slough-Frontal Columbia River \(170800030401\)](#)

Within Assessment Area No EO Records
 Within 1 mile No EO Records
 In HUC12 watershed 4 EO Records

Element of Occurrence Record(s) in HUC12

- 1 Steelhead (Lower Columbia River ESU, winter run)
 [1 occurrences]
 Oncorhynchus mykiss pop. 27
 ORBIC State Status: S2
 ORBIC Global Status: G5T2Q
 ODFW Strategy Species: Yes

- 2 Coho salmon (Lower Columbia River ESU)
 [1 occurrences]
 Oncorhynchus kisutch pop. 1
 ORBIC State Status: S2
 ORBIC Global Status: G5T2Q
 ODFW Strategy Species: No

- 3 Steelhead (Southwest Washington ESU, winter run)
 [2 occurrences]
 Oncorhynchus mykiss pop. 35
 ORBIC State Status: S2
 ORBIC Global Status: G5T3Q
 ODFW Strategy Species: Yes

- *HUC Best: Oregon watersheds (HUC8, HUC10, HUC12) with greatest type diversity, proportional area, or density of wetlands according to available National Wetland Inventory maps.*

"Type diversity" is the number of unique NWI codes in the watershed (e.g., PEMA, PEMC, PEMCx) and excluded types that have no vegetation component (e.g., PUBH, R3US2).

"Density" is the number of vegetated NWI polygons divided by the acreage of the watershed; many of these polygons may be contiguous with each other, forming a single wetland.

"Proportional Area" is the proportion of the watershed's total area occupied by vegetated wetlands as mapped by NWI.

- *The digital maps used to determine this do not show many wetlands or cover the entire state. Data were compiled only from watersheds that have been at least 90% mapped by NWI (see worksheets for HUC8, 10, and 12). Data were received in November 2008 from ORBIC.*

• *METHODS: The above 3 metrics can be strongly correlated with watershed size and with each other. To minimize that bias, the rankings of the residuals from a regression analysis were used, rather than simply the top-ranking watersheds, to identify the most "important" watersheds for each metric at each scale. That is, the watersheds were identified that were in the top 5% in terms of variety of mapped wetland types for watersheds of that size, the largest area of mapped wetlands as a proportion of the watershed area for watersheds of that size, and/or the greatest number of mapped wetland polygons for watersheds with that much wetland area.*

• *Global rank. ORBIC participates in an international system for ranking rare, threatened and endangered species throughout the world. The system was developed by The Nature Conservancy and is now maintained by NatureServe in cooperation with Heritage Programs or Conservation Data Centers (CDCs) in all 50 states, in 4 Canadian provinces, and in 13 Latin American countries. The ranking is a 1-5 scale, primarily based on the number of known occurrences, but also including threats, sensitivity, area occupied, and other biological factors. In this book, the ranks occupy two lines. The top line is the Global Rank and begins with a "G". If the taxon has a trinomial (a subspecies, variety or recognized race), this is followed by a "T" rank indicator. A "Q" at the end of this line indicates the taxon has taxonomic questions. The second line is the State Rank and begins with the letter "S". The ranks are summarized as follows: 1 = Critically imperiled because of extreme rarity or because it is somehow especially vulnerable to extinction or extirpation, typically with 5 or fewer occurrences; 2 = Imperiled because of rarity or because other factors demonstrably make it very vulnerable to extinction (extirpation), typically with 6-20 occurrences; 3 = Rare, uncommon or threatened, but not immediately imperiled, typically with 21-100 occurrences; 4 = Not rare and apparently secure, but with cause for long-term concern, usually with more than 100 occurrences; 5 = Demonstrably widespread, abundant, and secure; H = Historical Occurrence, formerly part of the native biota with the implied expectation that it may be rediscovered; X = Presumed extirpated or extinct; U = Unknown rank; ? = Not yet ranked, or assigned rank is uncertain.*

• *This report contains both centroid-based and polygon-based data. The Location Information and Watershed Information sections of the report contain centroid based data (determined by the center point of the polygon), while the remaining sections are polygon-based (determined from the entire polygon).*

• *The rare species results in this report are based on a subset of the ORBIC rare species dataset. The ORWAP tool only reports on rare species that meet the following criteria: wetland habitat species that are tracked by ORBIC, excluding historical or extirpated sites or those with low mapping accuracy. More information about specific sites and additional species can be obtained from ORBIC through data requests, see <https://inr.oregonstate.edu/orbic/data-requests> for details.*

Appendix C

Post-Project Wetland Functions and Values Assessment Forms

ORWAP Version 3.1. Cover Page: Basic Description of Assessment

Site Name:	Wetland A Post Construction
Investigator Name:	Julie Fox
Date of Field Assessment:	
County:	Columbia
Nearest Town:	Saint Helens
Latitude (decimal degrees):	
Longitude (decimal degrees):	
TRS, quarter/quarter section and tax lot(s):	
Approximate size of the Assessment Area (AA, in acres):	0.04 acres
AA as percent of entire wetland (approx.). Attach sketch map if AA is smaller than the entire contiguous wetland.	100%
If delineated, DSL file number (WD #) if known:	WD2019-0623
Cowardin Systems & Classes (indicate all present, based on field visit and/or aerial imagery): <u>Systems:</u> Palustrine =P, Riverine =R, Lacustrine =L, Estuarine =E <u>Classes:</u> Emergent =EM, Scrub-Shrub =SS, Forested =FO, Aquatic Bed (incl. SAV) =AB, Open Water =OW, Unconsolidated Bottom =UB, Unconsolidated Shore =US	PSSF
Predominant HGM Class: Estuarine=E, Lacustrine=L, Riverine=R, S= Slope, F= Flats, D= Depressional	Slope
Soil Unit Mapped in Most of the AA:	Rock Outcrop-Xerumbrepts Complex, Undulating
If tidal, the tidal phase during most of visit:	
What percent (approximate) of the wetland were you able to visit?	100%
What percent (approximate) of the AA were you able to visit?	100%
Have you attended an ORWAP training session? If so, indicate approximate month & year.	
How many wetlands have you assessed previously using ORWAP (approximate)?	

Site Name:	Wetland A Post Construction
Investigator Name:	Julie Fox
Date of Field Assessment:	
<i>Scores will appear below after data are entered in worksheets OF, F, T, and S. See Manual for definitions and descriptions of how scores were computed and ratings assigned.</i>	

<i>Normalized Scores & Ratings for this Assessment Area (AA):</i>						
Specific Functions or Values:	Function Score	Function Rating	Rating Break Proximity	Values Score	Values Rating	Rating Break Proximity
Water Storage & Delay (WS)	4.36	Moderate	LM	7.50	Higher	
Sediment Retention & Stabilization (SR)	3.16	Lower	LM	7.47	Higher	
Phosphorus Retention (PR)	2.59	Lower	LM	4.61	Moderate	
Nitrate Removal & Retention (NR)	2.87	Lower		10.00	Higher	
Anadromous Fish Habitat (FA)	0.00	Lower		0.00	Lower	
Resident Fish Habitat (FR)	0.00	Lower		0.00	Lower	
Amphibian & Reptile Habitat (AM)	7.72	Higher		2.37	Lower	
Waterbird Nesting Habitat (WBN)	7.40	Higher	MH	1.72	Moderate	LM
Waterbird Feeding Habitat (WBF)	9.10	Higher		2.08	Lower	LM
Aquatic Invertebrate Habitat (INV)	6.48	Moderate	MH	1.09	Lower	
Songbird, Raptor, Mammal Habitat (SBM)	3.63	Lower	LM	2.00	Lower	
Water Cooling (WC)	3.59	Moderate		0.67	Lower	
Native Plant Diversity (PD)	7.85	Higher		1.70	Lower	
Pollinator Habitat (POL)	5.72	Moderate		1.03	Lower	
Organic Nutrient Export (OE)	6.31	Moderate				
Carbon Sequestration (CS)	4.12	Moderate	LM			
Public Use & Recognition (PU)				1.76	Lower	

Other Attributes:	Score	Rating	Rating Break Proximity
Wetland Sensitivity (SEN)	1.35	Lower	
Wetland Ecological Condition (EC)	3.48	Moderate	LM
Wetland Stressors (STR)	3.33	Lower	LM

GROUPS	Selected Function	Function Rating	Rating Break Proximity	Values Rating	Rating Break Proximity
Hydrologic Function (WS)	Water Storage & Delay (WS)	Moderate	LM	Higher	
Water Quality Support (SR, PR, or NR)	Sediment Retention & Stabilization (SR)	Lower	LM	Higher	
Fish Habitat (FA or FR)	Anadromous Fish Habitat (FA)	Lower		Lower	
Aquatic Habitat (AM, WBF, or WBN)	Waterbird Nesting Habitat (WBN)	Higher	MH	Moderate	LM
Ecosystem Support (WC, INV, PD, POL, SBM, or OE)	Native Plant Diversity (PD)	Higher		Lower	

ORWAP Version 3.1. Cover Page: Basic Description of Assessment

Site Name:	Wetlands B and TT Post Construction
Investigator Name:	Julie Fox
Date of Field Assessment:	
County:	Columbia
Nearest Town:	Saint Helens
Latitude (decimal degrees):	
Longitude (decimal degrees):	
TRS, quarter/quarter section and tax lot(s):	
Approximate size of the Assessment Area (AA, in acres):	4.61 acres
AA as percent of entire wetland (approx.). Attach sketch map if AA is smaller than the entire contiguous wetland.	100%
If delineated, DSL file number (WD #) if known:	WD2019-0623
Cowardin Systems & Classes (indicate all present, based on field visit and/or aerial imagery): <u>Systems:</u> Palustrine =P, Riverine =R, Lacustrine =L, Estuarine =E <u>Classes:</u> Emergent =EM, Scrub-Shrub =SS, Forested =FO, Aquatic Bed (incl. SAV) =AB, Open Water =OW, Unconsolidated Bottom =UB, Unconsolidated Shore =US	PFOE/PEMC
Predominant HGM Class: Estuarine=E, Lacustrine=L, Riverine=R, S= Slope, F= Flats, D= Depressional	Slope/Depressional Outflow
Soil Unit Mapped in Most of the AA:	Rock Outcrop-Xerumbrepts Complex, Undulating
If tidal, the tidal phase during most of visit:	
What percent (approximate) of the wetland were you able to visit?	100%
What percent (approximate) of the AA were you able to visit?	100%
Have you attended an ORWAP training session? If so, indicate approximate month & year.	No
How many wetlands have you assessed previously using ORWAP (approximate)?	

Site Name:	Wetlands B and TT Post Construction
Investigator Name:	Julie Fox
Date of Field Assessment:	
<i>Scores will appear below after data are entered in worksheets OF, F, T, and S. See Manual for definitions and descriptions of how scores were computed and ratings assigned.</i>	

<i>Normalized Scores & Ratings for this Assessment Area (AA):</i>						
Specific Functions or Values:	Function Score	Function Rating	Rating Break Proximity	Values Score	Values Rating	Rating Break Proximity
Water Storage & Delay (WS)	4.25	Moderate	LM	7.50	Higher	
Sediment Retention & Stabilization (SR)	4.28	Moderate		6.77	Higher	
Phosphorus Retention (PR)	2.83	Lower	LM	3.76	Moderate	LM
Nitrate Removal & Retention (NR)	4.02	Moderate	LM	10.00	Higher	
Anadromous Fish Habitat (FA)	0.00	Lower		0.00	Lower	
Resident Fish Habitat (FR)	0.00	Lower		0.00	Lower	
Amphibian & Reptile Habitat (AM)	7.69	Higher		2.44	Lower	
Waterbird Nesting Habitat (WBN)	7.85	Higher		1.72	Moderate	LM
Waterbird Feeding Habitat (WBF)	9.62	Higher		2.08	Lower	LM
Aquatic Invertebrate Habitat (INV)	6.24	Moderate	MH	1.15	Lower	
Songbird, Raptor, Mammal Habitat (SBM)	4.61	Moderate		2.00	Lower	
Water Cooling (WC)	10.00	Higher		0.61	Lower	
Native Plant Diversity (PD)	8.23	Higher		2.03	Lower	
Pollinator Habitat (POL)	7.16	Higher	MH	1.03	Lower	
Organic Nutrient Export (OE)	7.28	Higher	MH			
Carbon Sequestration (CS)	5.26	Moderate				
Public Use & Recognition (PU)				1.82	Lower	

Other Attributes:	Score	Rating	Rating Break Proximity
Wetland Sensitivity (SEN)	1.41	Lower	
Wetland Ecological Condition (EC)	4.02	Moderate	
Wetland Stressors (STR)	3.33	Lower	LM

GROUPS	Selected Function	Function Rating	Rating Break Proximity	Values Rating	Rating Break Proximity
Hydrologic Function (WS)	Water Storage & Delay (WS)	Moderate	LM	Higher	
Water Quality Support (SR, PR, or NR)	Sediment Retention & Stabilization (SR)	Moderate		Higher	
Fish Habitat (FA or FR)	Anadromous Fish Habitat (FA)	Lower		Lower	
Aquatic Habitat (AM, WBF, or WBN)	Waterbird Nesting Habitat (WBN)	Higher		Moderate	LM
Ecosystem Support (WC, INV, PD, POL, SBM, or OE)	Organic Nutrient Export (OE)	Higher	MH	0.00	0.00

ORWAP Version 3.1. Cover Page: Basic Description of Assessment

Site Name:	Wetland C Post Construction
Investigator Name:	Julie Fox
Date of Field Assessment:	
County:	Columbia
Nearest Town:	Saint Helens
Latitude (decimal degrees):	
Longitude (decimal degrees):	
TRS, quarter/quarter section and tax lot(s):	
Approximate size of the Assessment Area (AA, in acres):	1.33 acres
AA as percent of entire wetland (approx.). Attach sketch map if AA is smaller than the entire contiguous wetland.	100%
If delineated, DSL file number (WD #) if known:	WD2019-0623
Cowardin Systems & Classes (indicate all present, based on field visit and/or aerial imagery): <u>Systems:</u> Palustrine =P, Riverine =R, Lacustrine =L, Estuarine =E <u>Classes:</u> Emergent =EM, Scrub-Shrub =SS, Forested =FO, Aquatic Bed (incl. SAV) =AB, Open Water =OW, Unconsolidated Bottom =UB, Unconsolidated Shore =US	PFOE
Predominant HGM Class: Estuarine=E, Lacustrine=L, Riverine=R, S= Slope, F= Flats, D= Depressional	Slope
Soil Unit Mapped in Most of the AA:	Rock Outcrop-Xerumbrepts Complex, Undulating
If tidal, the tidal phase during most of visit:	
What percent (approximate) of the wetland were you able to visit?	100%
What percent (approximate) of the AA were you able to visit?	100%
Have you attended an ORWAP training session? If so, indicate approximate month & year.	No
How many wetlands have you assessed previously using ORWAP (approximate)?	

Site Name:	Wetland C Post Construction
Investigator Name:	Julie Fox
Date of Field Assessment:	
<i>Scores will appear below after data are entered in worksheets OF, F, T, and S. See Manual for definitions and descriptions of how scores were computed and ratings assigned.</i>	

<i>Normalized Scores & Ratings for this Assessment Area (AA):</i>						
Specific Functions or Values:	Function Score	Function Rating	Rating Break Proximity	Values Score	Values Rating	Rating Break Proximity
Water Storage & Delay (WS)	4.62	Moderate		7.50	Higher	
Sediment Retention & Stabilization (SR)	5.67	Moderate		7.30	Higher	
Phosphorus Retention (PR)	3.41	Moderate	LM	4.25	Moderate	
Nitrate Removal & Retention (NR)	4.91	Moderate		10.00	Higher	
Anadromous Fish Habitat (FA)	0.00	Lower		0.00	Lower	
Resident Fish Habitat (FR)	0.00	Lower		0.00	Lower	
Amphibian & Reptile Habitat (AM)	7.69	Higher		2.42	Lower	
Waterbird Nesting Habitat (WBN)	7.67	Higher		1.72	Moderate	LM
Waterbird Feeding Habitat (WBF)	9.49	Higher		2.08	Lower	LM
Aquatic Invertebrate Habitat (INV)	7.90	Higher		1.14	Lower	
Songbird, Raptor, Mammal Habitat (SBM)	4.56	Moderate		2.00	Lower	
Water Cooling (WC)	7.20	Higher		0.61	Lower	
Native Plant Diversity (PD)	8.21	Higher		2.00	Lower	
Pollinator Habitat (POL)	7.05	Higher	MH	1.03	Lower	
Organic Nutrient Export (OE)	7.13	Higher	MH			
Carbon Sequestration (CS)	5.56	Moderate				
Public Use & Recognition (PU)				1.82	Lower	

Other Attributes:	Score	Rating	Rating Break Proximity
Wetland Sensitivity (SEN)	1.09	Lower	
Wetland Ecological Condition (EC)	2.32	Lower	LM
Wetland Stressors (STR)	5.00	Moderate	

GROUPS	Selected Function	Function Rating	Rating Break Proximity	Values Rating	Rating Break Proximity
Hydrologic Function (WS)	Water Storage & Delay (WS)	Moderate		Higher	
Water Quality Support (SR, PR, or NR)	Sediment Retention & Stabilization (SR)	Moderate		Higher	
Fish Habitat (FA or FR)	Anadromous Fish Habitat (FA)	Lower		Lower	
Aquatic Habitat (AM, WBF, or WBN)	Waterbird Nesting Habitat (WBN)	Higher		Moderate	LM
Ecosystem Support (WC, INV, PD, POL, SBM, or OE)	Organic Nutrient Export (OE)	Higher	MH	0.00	0.00

ORWAP Version 3.1. Cover Page: Basic Description of Assessment

Site Name:	Wetlands F and G Post Construction
Investigator Name:	Julie Fox
Date of Field Assessment:	
County:	Columbia
Nearest Town:	St. Helens
Latitude (decimal degrees):	
Longitude (decimal degrees):	
TRS, quarter/quarter section and tax lot(s):	
Approximate size of the Assessment Area (AA, in acres):	0.08 acres
AA as percent of entire wetland (approx.). Attach sketch map if AA is smaller than the entire contiguous wetland.	100%
If delineated, DSL file number (WD #) if known:	WD2019-0623
Cowardin Systems & Classes (indicate all present, based on field visit and/or aerial imagery): Systems: Palustrine =P, Riverine =R, Lacustrine =L, Estuarine =E Classes: Emergent =EM, Scrub-Shrub =SS, Forested =FO, Aquatic Bed (incl. SAV) =AB, Open Water =OW, Unconsolidated Bottom =UB, Unconsolidated Shore =US	PEME
Predominant HGM Class: Estuarine=E, Lacustrine=L, Riverine=R, S= Slope, F= Flats, D= Depressional	Depressional
Soil Unit Mapped in Most of the AA:	Rock Outcrop-Xerumbrepts Complex, Undulating
If tidal, the tidal phase during most of visit:	
What percent (approximate) of the wetland were you able to visit?	100%
What percent (approximate) of the AA were you able to visit?	100%
Have you attended an ORWAP training session? If so, indicate approximate month & year.	
How many wetlands have you assessed previously using ORWAP (approximate)?	

Site Name:	Wetlands F and G Post Construction
Investigator Name:	Julie Fox
Date of Field Assessment:	
<i>Scores will appear below after data are entered in worksheets OF, F, T, and S. See Manual for definitions and descriptions of how scores were computed and ratings assigned.</i>	

<i>Normalized Scores & Ratings for this Assessment Area (AA):</i>						
Specific Functions or Values:	Function Score	Function Rating	Rating Break Proximity	Values Score	Values Rating	Rating Break Proximity
Water Storage & Delay (WS)	10.00	Higher		7.50	Higher	
Sediment Retention & Stabilization (SR)	10.00	Higher		6.77	Higher	
Phosphorus Retention (PR)	10.00	Higher		3.55	Moderate	LM
Nitrate Removal & Retention (NR)	10.00	Higher		10.00	Higher	
Anadromous Fish Habitat (FA)	0.00	Lower		0.00	Lower	
Resident Fish Habitat (FR)	0.00	Lower		0.00	Lower	
Amphibian & Reptile Habitat (AM)	7.67	Higher		2.33	Lower	
Waterbird Nesting Habitat (WBN)	6.44	Moderate		1.72	Moderate	LM
Waterbird Feeding Habitat (WBF)	8.81	Higher		2.08	Lower	LM
Aquatic Invertebrate Habitat (INV)	3.82	Lower	LM	1.08	Lower	
Songbird, Raptor, Mammal Habitat (SBM)	3.71	Moderate	LM	2.00	Lower	
Water Cooling (WC)	1.88	Lower	LM	0.00	Lower	
Native Plant Diversity (PD)	8.53	Higher		1.79	Lower	
Pollinator Habitat (POL)	6.30	Moderate	MH	1.03	Lower	
Organic Nutrient Export (OE)	0.00	Lower				
Carbon Sequestration (CS)	5.07	Moderate				
Public Use & Recognition (PU)				1.76	Lower	

Other Attributes:	Score	Rating	Rating Break Proximity
Wetland Sensitivity (SEN)	1.97	Lower	LM
Wetland Ecological Condition (EC)	5.56	Higher	MH
Wetland Stressors (STR)	5.00	Moderate	

GROUPS	Selected Function	Function Rating	Rating Break Proximity	Values Rating	Rating Break Proximity
Hydrologic Function (WS)	Water Storage & Delay (WS)	Higher		Higher	
Water Quality Support (SR, PR, or NR)	Sediment Retention & Stabilization (SR)	Higher		Higher	
Fish Habitat (FA or FR)	Anadromous Fish Habitat (FA)	Lower		Lower	
Aquatic Habitat (AM, WBF, or WBN)	Amphibian & Reptile Habitat (AM)	Higher		Lower	
Ecosystem Support (WC, INV, PD, POL, SBM, or OE)	Native Plant Diversity (PD)	Higher		Lower	

ORWAP Version 3.1. Cover Page: Basic Description of Assessment

Site Name:	Wetland M Post-Construction
Investigator Name:	Julie Fox
Date of Field Assessment:	
County:	Columbia
Nearest Town:	St. Helens
Latitude (decimal degrees):	
Longitude (decimal degrees):	
TRS, quarter/quarter section and tax lot(s):	
Approximate size of the Assessment Area (AA, in acres):	1.42 acres
AA as percent of entire wetland (approx.). Attach sketch map if AA is smaller than the entire contiguous wetland.	100%
If delineated, DSL file number (WD #) if known:	WD2019-0623
Cowardin Systems & Classes (indicate all present, based on field visit and/or aerial imagery): <u>Systems:</u> Palustrine =P, Riverine =R, Lacustrine =L, Estuarine =E <u>Classes:</u> Emergent =EM, Scrub-Shrub =SS, Forested =FO, Aquatic Bed (incl. SAV) =AB, Open Water =OW, Unconsolidated Bottom =UB, Unconsolidated Shore =US	PFOE/PEMC
Predominant HGM Class: Estuarine=E, Lacustrine=L, Riverine=R, S= Slope, F= Flats, D= Depressional	Depressional Outflow
Soil Unit Mapped in Most of the AA:	Rock Outcrop-Xerumbrepts Complex, Undulating
If tidal, the tidal phase during most of visit:	
What percent (approximate) of the wetland were you able to visit?	100%
What percent (approximate) of the AA were you able to visit?	100%
Have you attended an ORWAP training session? If so, indicate approximate month & year.	No
How many wetlands have you assessed previously using ORWAP (approximate)?	

Site Name:	Wetland M Post-Construction
Investigator Name:	Julie Fox
Date of Field Assessment:	
<i>Scores will appear below after data are entered in worksheets OF, F, T, and S. See Manual for definitions and descriptions of how scores were computed and ratings assigned.</i>	

<i>Normalized Scores & Ratings for this Assessment Area (AA):</i>						
Specific Functions or Values:	Function Score	Function Rating	Rating Break Proximity	Values Score	Values Rating	Rating Break Proximity
Water Storage & Delay (WS)	3.02	Lower		7.50	Higher	
Sediment Retention & Stabilization (SR)	3.44	Lower	LM	7.30	Higher	
Phosphorus Retention (PR)	2.65	Lower	LM	4.18	Moderate	
Nitrate Removal & Retention (NR)	4.20	Moderate	LM	10.00	Higher	
Anadromous Fish Habitat (FA)	0.00	Lower		0.00	Lower	
Resident Fish Habitat (FR)	0.00	Lower		0.00	Lower	
Amphibian & Reptile Habitat (AM)	7.87	Higher		2.38	Lower	
Waterbird Nesting Habitat (WBN)	7.84	Higher		1.72	Moderate	LM
Waterbird Feeding Habitat (WBF)	9.18	Higher		2.08	Lower	LM
Aquatic Invertebrate Habitat (INV)	9.26	Higher		1.16	Lower	
Songbird, Raptor, Mammal Habitat (SBM)	5.00	Moderate		2.00	Lower	
Water Cooling (WC)	2.62	Moderate	LM	1.06	Lower	
Native Plant Diversity (PD)	8.59	Higher		10.00	Higher	
Pollinator Habitat (POL)	7.45	Higher	MH	1.03	Lower	
Organic Nutrient Export (OE)	7.01	Higher	MH			
Carbon Sequestration (CS)	4.14	Moderate	LM			
Public Use & Recognition (PU)				3.75	Lower	LM

Other Attributes:	Score	Rating	Rating Break Proximity
Wetland Sensitivity (SEN)	5.94	Higher	
Wetland Ecological Condition (EC)	4.02	Moderate	
Wetland Stressors (STR)	3.33	Lower	LM

GROUPS	Selected Function	Function Rating	Rating Break Proximity	Values Rating	Rating Break Proximity
Hydrologic Function (WS)	Water Storage & Delay (WS)	Lower		Higher	
Water Quality Support (SR, PR, or NR)	Nitrate Removal & Retention (NR)	Moderate	LM	Higher	
Fish Habitat (FA or FR)	Anadromous Fish Habitat (FA)	Lower		Lower	
Aquatic Habitat (AM, WBF, or WBN)	Waterbird Nesting Habitat (WBN)	Higher		Moderate	LM
Ecosystem Support (WC, INV, PD, POL, SBM, or OE)	Native Plant Diversity (PD)	Higher		Higher	

ORWAP Version 3.1. Cover Page: Basic Description of Assessment

Site Name:	Wetland U Post Construction
Investigator Name:	Julie Fox
Date of Field Assessment:	
County:	Columbia
Nearest Town:	St. Helens
Latitude (decimal degrees):	
Longitude (decimal degrees):	
TRS, quarter/quarter section and tax lot(s):	
Approximate size of the Assessment Area (AA, in acres):	0.04 acres
AA as percent of entire wetland (approx.). Attach sketch map if AA is smaller than the entire contiguous wetland.	100%
If delineated, DSL file number (WD #) if known:	WD2019-0623
Cowardin Systems & Classes (indicate all present, based on field visit and/or aerial imagery): <u>Systems:</u> Palustrine =P, Riverine =R, Lacustrine =L, Estuarine =E <u>Classes:</u> Emergent =EM, Scrub-Shrub =SS, Forested =FO, Aquatic Bed (incl. SAV) =AB, Open Water =OW, Unconsolidated Bottom =UB, Unconsolidated Shore =US	PEMC
Predominant HGM Class: Estuarine=E, Lacustrine=L, Riverine=R, S= Slope, F= Flats, D= Depressional	Depressional
Soil Unit Mapped in Most of the AA:	Rock Outcrop-Xerumbrepts Complex, Undulating
If tidal, the tidal phase during most of visit:	
What percent (approximate) of the wetland were you able to visit?	100%
What percent (approximate) of the AA were you able to visit?	100%
Have you attended an ORWAP training session? If so, indicate approximate month & year.	
How many wetlands have you assessed previously using ORWAP (approximate)?	

Site Name:	Wetland U Post Construction
Investigator Name:	Julie Fox
Date of Field Assessment:	
<i>Scores will appear below after data are entered in worksheets OF, F, T, and S. See Manual for definitions and descriptions of how scores were computed and ratings assigned.</i>	

<i>Normalized Scores & Ratings for this Assessment Area (AA):</i>						
Specific Functions or Values:	Function Score	Function Rating	Rating Break Proximity	Values Score	Values Rating	Rating Break Proximity
Water Storage & Delay (WS)	4.14	Moderate	LM	7.50	Higher	
Sediment Retention & Stabilization (SR)	2.84	Lower		7.17	Higher	
Phosphorus Retention (PR)	2.22	Lower		3.86	Moderate	LM
Nitrate Removal & Retention (NR)	2.11	Lower		10.00	Higher	
Anadromous Fish Habitat (FA)	0.00	Lower		0.00	Lower	
Resident Fish Habitat (FR)	0.00	Lower		0.00	Lower	
Amphibian & Reptile Habitat (AM)	7.85	Higher		1.11	Lower	
Waterbird Nesting Habitat (WBN)	0.00	Lower		0.00	Lower	
Waterbird Feeding Habitat (WBF)	0.00	Lower		0.00	Lower	
Aquatic Invertebrate Habitat (INV)	3.95	Lower	LM	0.65	Lower	
Songbird, Raptor, Mammal Habitat (SBM)	2.54	Lower		2.00	Lower	
Water Cooling (WC)	2.25	Lower	LM	0.63	Lower	
Native Plant Diversity (PD)	6.17	Moderate	MH	10.00	Higher	
Pollinator Habitat (POL)	4.64	Moderate		1.03	Lower	
Organic Nutrient Export (OE)	7.19	Higher	MH			
Carbon Sequestration (CS)	2.75	Lower				
Public Use & Recognition (PU)				1.88	Lower	

Other Attributes:	Score	Rating	Rating Break Proximity
Wetland Sensitivity (SEN)	4.47	Higher	MH
Wetland Ecological Condition (EC)	0.72	Lower	
Wetland Stressors (STR)	3.33	Lower	LM

GROUPS	Selected Function	Function Rating	Rating Break Proximity	Values Rating	Rating Break Proximity
Hydrologic Function (WS)	Water Storage & Delay (WS)	Moderate	LM	Higher	
Water Quality Support (SR, PR, or NR)	Sediment Retention & Stabilization (SR)	Lower		Higher	
Fish Habitat (FA or FR)	Anadromous Fish Habitat (FA)	Lower		Lower	
Aquatic Habitat (AM, WBF, or WBN)	Amphibian & Reptile Habitat (AM)	Higher		Lower	
Ecosystem Support (WC, INV, PD, POL, SBM, or OE)	Organic Nutrient Export (OE)	Higher	MH	0.00	0.00

ORWAP Version 3.1. Cover Page: Basic Description of Assessment

Site Name:	Wetland Z Post Construction
Investigator Name:	Julie Fox
Date of Field Assessment:	
County:	Columbia
Nearest Town:	St. Helens
Latitude (decimal degrees):	
Longitude (decimal degrees):	
TRS, quarter/quarter section and tax lot(s):	
Approximate size of the Assessment Area (AA, in acres):	0.15 acres
AA as percent of entire wetland (approx.). Attach sketch map if AA is smaller than the entire contiguous wetland.	100%
If delineated, DSL file number (WD #) if known:	WD2019-0623
Cowardin Systems & Classes (indicate all present, based on field visit and/or aerial imagery): Systems: Palustrine =P, Riverine =R, Lacustrine =L, Estuarine =E Classes: Emergent =EM, Scrub-Shrub =SS, Forested =FO, Aquatic Bed (incl. SAV) =AB, Open Water =OW, Unconsolidated Bottom =UB, Unconsolidated Shore =US	PFOE
Predominant HGM Class: Estuarine=E, Lacustrine=L, Riverine=R, S= Slope, F= Flats, D= Depressional	Depressional
Soil Unit Mapped in Most of the AA:	Rock Outcrop-Xerumbrepts Complex, Undulating
If tidal, the tidal phase during most of visit:	
What percent (approximate) of the wetland were you able to visit?	100%
What percent (approximate) of the AA were you able to visit?	100%
Have you attended an ORWAP training session? If so, indicate approximate month & year.	
How many wetlands have you assessed previously using ORWAP (approximate)?	

Site Name:	Wetland Z Post Construction
Investigator Name:	Julie Fox
Date of Field Assessment:	
<i>Scores will appear below after data are entered in worksheets OF, F, T, and S. See Manual for definitions and descriptions of how scores were computed and ratings assigned.</i>	

<i>Normalized Scores & Ratings for this Assessment Area (AA):</i>						
Specific Functions or Values:	Function Score	Function Rating	Rating Break Proximity	Values Score	Values Rating	Rating Break Proximity
Water Storage & Delay (WS)	10.00	Higher		7.50	Higher	
Sediment Retention & Stabilization (SR)	10.00	Higher		6.96	Higher	
Phosphorus Retention (PR)	10.00	Higher		3.68	Moderate	LM
Nitrate Removal & Retention (NR)	10.00	Higher		10.00	Higher	
Anadromous Fish Habitat (FA)	0.00	Lower		0.00	Lower	
Resident Fish Habitat (FR)	0.00	Lower		0.00	Lower	
Amphibian & Reptile Habitat (AM)	7.92	Higher		2.38	Lower	
Waterbird Nesting Habitat (WBN)	7.45	Higher	MH	1.72	Moderate	LM
Waterbird Feeding Habitat (WBF)	9.22	Higher		2.08	Lower	LM
Aquatic Invertebrate Habitat (INV)	6.06	Moderate		1.09	Lower	
Songbird, Raptor, Mammal Habitat (SBM)	3.31	Lower	LM	2.00	Lower	
Water Cooling (WC)	3.69	Moderate		0.00	Lower	
Native Plant Diversity (PD)	6.66	Higher	MH	1.48	Lower	
Pollinator Habitat (POL)	4.46	Moderate		1.03	Lower	
Organic Nutrient Export (OE)	0.00	Lower				
Carbon Sequestration (CS)	5.59	Moderate				
Public Use & Recognition (PU)				1.88	Lower	

Other Attributes:	Score	Rating	Rating Break Proximity
Wetland Sensitivity (SEN)	2.15	Lower	LM
Wetland Ecological Condition (EC)	2.99	Moderate	LM
Wetland Stressors (STR)	5.00	Moderate	

GROUPS	Selected Function	Function Rating	Rating Break Proximity	Values Rating	Rating Break Proximity
Hydrologic Function (WS)	Water Storage & Delay (WS)	Higher		Higher	
Water Quality Support (SR, PR, or NR)	Sediment Retention & Stabilization (SR)	Higher		Higher	
Fish Habitat (FA or FR)	Anadromous Fish Habitat (FA)	Lower		Lower	
Aquatic Habitat (AM, WBF, or WBN)	Waterbird Nesting Habitat (WBN)	Higher	MH	Moderate	LM
Ecosystem Support (WC, INV, PD, POL, SBM, or OE)	Native Plant Diversity (PD)	Higher	MH	Lower	

ORWAP Version 3.1. Cover Page: Basic Description of Assessment

Site Name:	Wetland DD Post Construction
Investigator Name:	Julie Fox
Date of Field Assessment:	
County:	Columbia
Nearest Town:	St. Helens
Latitude (decimal degrees):	
Longitude (decimal degrees):	
TRS, quarter/quarter section and tax lot(s):	
Approximate size of the Assessment Area (AA, in acres):	0.10 acres
AA as percent of entire wetland (approx.). Attach sketch map if AA is smaller than the entire contiguous wetland.	100%
If delineated, DSL file number (WD #) if known:	WD2019-0623
Cowardin Systems & Classes (indicate all present, based on field visit and/or aerial imagery): Systems: Palustrine =P, Riverine =R, Lacustrine =L, Estuarine =E Classes: Emergent =EM, Scrub-Shrub =SS, Forested =FO, Aquatic Bed (incl. SAV) =AB, Open Water =OW, Unconsolidated Bottom =UB, Unconsolidated Shore =US	PFOE
Predominant HGM Class: Estuarine=E, Lacustrine=L, Riverine=R, S= Slope, F= Flats, D= Depressional	Depressional
Soil Unit Mapped in Most of the AA:	Rock Outcrop-Xerumbrepts Complex, Undulating
If tidal, the tidal phase during most of visit:	
What percent (approximate) of the wetland were you able to visit?	100%
What percent (approximate) of the AA were you able to visit?	100%
Have you attended an ORWAP training session? If so, indicate approximate month & year.	
How many wetlands have you assessed previously using ORWAP (approximate)?	

Site Name:	Wetland DD Post Construction
Investigator Name:	Julie Fox
Date of Field Assessment:	
<i>Scores will appear below after data are entered in worksheets OF, F, T, and S. See Manual for definitions and descriptions of how scores were computed and ratings assigned.</i>	

<i>Normalized Scores & Ratings for this Assessment Area (AA):</i>						
Specific Functions or Values:	Function Score	Function Rating	Rating Break Proximity	Values Score	Values Rating	Rating Break Proximity
Water Storage & Delay (WS)	10.00	Higher		7.50	Higher	
Sediment Retention & Stabilization (SR)	10.00	Higher		7.05	Higher	
Phosphorus Retention (PR)	10.00	Higher		3.75	Moderate	LM
Nitrate Removal & Retention (NR)	10.00	Higher		10.00	Higher	
Anadromous Fish Habitat (FA)	0.00	Lower		0.00	Lower	
Resident Fish Habitat (FR)	0.00	Lower		0.00	Lower	
Amphibian & Reptile Habitat (AM)	7.51	Higher		2.39	Lower	
Waterbird Nesting Habitat (WBN)	7.85	Higher		1.72	Moderate	LM
Waterbird Feeding Habitat (WBF)	9.23	Higher		2.08	Lower	LM
Aquatic Invertebrate Habitat (INV)	7.50	Higher	MH	1.08	Lower	
Songbird, Raptor, Mammal Habitat (SBM)	3.42	Lower	LM	2.00	Lower	
Water Cooling (WC)	8.00	Higher		0.00	Lower	
Native Plant Diversity (PD)	6.91	Higher	MH	1.66	Lower	
Pollinator Habitat (POL)	5.62	Moderate		1.03	Lower	
Organic Nutrient Export (OE)	0.00	Lower				
Carbon Sequestration (CS)	4.71	Moderate				
Public Use & Recognition (PU)				1.88	Lower	

Other Attributes:	Score	Rating	Rating Break Proximity
Wetland Sensitivity (SEN)	2.04	Lower	LM
Wetland Ecological Condition (EC)	3.04	Moderate	LM
Wetland Stressors (STR)	5.00	Moderate	

GROUPS	Selected Function	Function Rating	Rating Break Proximity	Values Rating	Rating Break Proximity
Hydrologic Function (WS)	Water Storage & Delay (WS)	Higher		Higher	
Water Quality Support (SR, PR, or NR)	Sediment Retention & Stabilization (SR)	Higher		Higher	
Fish Habitat (FA or FR)	Anadromous Fish Habitat (FA)	Lower		Lower	
Aquatic Habitat (AM, WBF, or WBN)	Waterbird Nesting Habitat (WBN)	Higher		Moderate	LM
Ecosystem Support (WC, INV, PD, POL, SBM, or OE)	Aquatic Invertebrate Habitat (INV)	Higher	MH	Lower	

ORWAP Version 3.1. Cover Page: Basic Description of Assessment

Site Name:	Wetlands EE and FF Post Construction
Investigator Name:	Julie Fox
Date of Field Assessment:	
County:	Columbia
Nearest Town:	St. Helens
Latitude (decimal degrees):	
Longitude (decimal degrees):	
TRS, quarter/quarter section and tax lot(s):	
Approximate size of the Assessment Area (AA, in acres):	0.65 acres
AA as percent of entire wetland (approx.). Attach sketch map if AA is smaller than the entire contiguous wetland.	100%
If delineated, DSL file number (WD #) if known:	WD2019-0623
Cowardin Systems & Classes (indicate all present, based on field visit and/or aerial imagery): Systems: Palustrine =P, Riverine =R, Lacustrine =L, Estuarine =E Classes: Emergent =EM, Scrub-Shrub =SS, Forested =FO, Aquatic Bed (incl. SAV) =AB, Open Water =OW, Unconsolidated Bottom =UB, Unconsolidated Shore =US	PFOE
Predominant HGM Class: Estuarine=E, Lacustrine=L, Riverine=R, S= Slope, F= Flats, D= Depressional	Depressional
Soil Unit Mapped in Most of the AA:	Rock Outcrop-Xerumbrepts Complex, Undulating
If tidal, the tidal phase during most of visit:	
What percent (approximate) of the wetland were you able to visit?	100%
What percent (approximate) of the AA were you able to visit?	100%
Have you attended an ORWAP training session? If so, indicate approximate month & year.	
How many wetlands have you assessed previously using ORWAP (approximate)?	

Site Name:	Wetlands EE and FF Post Construction
Investigator Name:	Julie Fox
Date of Field Assessment:	
<i>Scores will appear below after data are entered in worksheets OF, F, T, and S. See Manual for definitions and descriptions of how scores were computed and ratings assigned.</i>	

<i>Normalized Scores & Ratings for this Assessment Area (AA):</i>						
Specific Functions or Values:	Function Score	Function Rating	Rating Break Proximity	Values Score	Values Rating	Rating Break Proximity
Water Storage & Delay (WS)	10.00	Higher		7.50	Higher	
Sediment Retention & Stabilization (SR)	10.00	Higher		6.86	Higher	
Phosphorus Retention (PR)	10.00	Higher		3.61	Moderate	LM
Nitrate Removal & Retention (NR)	10.00	Higher		10.00	Higher	
Anadromous Fish Habitat (FA)	0.00	Lower		0.00	Lower	
Resident Fish Habitat (FR)	0.00	Lower		0.00	Lower	
Amphibian & Reptile Habitat (AM)	7.60	Higher		2.41	Lower	
Waterbird Nesting Habitat (WBN)	7.96	Higher		1.72	Moderate	LM
Waterbird Feeding Habitat (WBF)	9.42	Higher		2.08	Lower	LM
Aquatic Invertebrate Habitat (INV)	6.60	Moderate	MH	1.08	Lower	
Songbird, Raptor, Mammal Habitat (SBM)	3.01	Lower		2.00	Lower	
Water Cooling (WC)	9.83	Higher		0.00	Lower	
Native Plant Diversity (PD)	7.20	Higher	MH	1.64	Lower	
Pollinator Habitat (POL)	5.86	Moderate		1.03	Lower	
Organic Nutrient Export (OE)	0.00	Lower				
Carbon Sequestration (CS)	4.98	Moderate				
Public Use & Recognition (PU)				1.88	Lower	

Other Attributes:	Score	Rating	Rating Break Proximity
Wetland Sensitivity (SEN)	2.27	Moderate	LM
Wetland Ecological Condition (EC)	1.46	Lower	
Wetland Stressors (STR)	5.00	Moderate	

GROUPS	Selected Function	Function Rating	Rating Break Proximity	Values Rating	Rating Break Proximity
Hydrologic Function (WS)	Water Storage & Delay (WS)	Higher		Higher	
Water Quality Support (SR, PR, or NR)	Sediment Retention & Stabilization (SR)	Higher		Higher	
Fish Habitat (FA or FR)	Anadromous Fish Habitat (FA)	Lower		Lower	
Aquatic Habitat (AM, WBF, or WBN)	Waterbird Nesting Habitat (WBN)	Higher		Moderate	LM
Ecosystem Support (WC, INV, PD, POL, SBM, or OE)	Water Cooling (WC)	Higher		Lower	

ORWAP Version 3.1. Cover Page: Basic Description of Assessment

Site Name:	Wetland OO
Investigator Name:	Julie Fox
Date of Field Assessment:	6/10/2020
County:	Columbia
Nearest Town:	St. Helens
Latitude (decimal degrees):	
Longitude (decimal degrees):	
TRS, quarter/quarter section and tax lot(s):	
Approximate size of the Assessment Area (AA, in acres):	0.1 acre
AA as percent of entire wetland (approx.). Attach sketch map if AA is smaller than the entire contiguous wetland.	100%
If delineated, DSL file number (WD #) if known:	WD2019-0623
Cowardin Systems & Classes (indicate all present, based on field visit and/or aerial imagery): <u>Systems:</u> Palustrine =P, Riverine =R, Lacustrine =L, Estuarine =E <u>Classes:</u> Emergent =EM, Scrub-Shrub =SS, Forested =FO, Aquatic Bed (incl. SAV) =AB, Open Water =OW, Unconsolidated Bottom =UB, Unconsolidated Shore =US	PEMC
Predominant HGM Class: Estuarine=E, Lacustrine=L, Riverine=R, S= Slope, F= Flats, D= Depressional	Depressional Outflow
Soil Unit Mapped in Most of the AA:	Rock Outcrop-Xerumbrepts Complex, Undulating
If tidal, the tidal phase during most of visit:	
What percent (approximate) of the wetland were you able to visit?	100%
What percent (approximate) of the AA were you able to visit?	100%
Have you attended an ORWAP training session? If so, indicate approximate month & year.	
How many wetlands have you assessed previously using ORWAP (approximate)?	

Site Name:	Wetland OO
Investigator Name:	Julie Fox
Date of Field Assessment:	6/10/2020
<i>Scores will appear below after data are entered in worksheets OF, F, T, and S. See Manual for definitions and descriptions of how scores were computed and ratings assigned.</i>	

<i>Normalized Scores & Ratings for this Assessment Area (AA):</i>						
Specific Functions or Values:	Function Score	Function Rating	Rating Break Proximity	Values Score	Values Rating	Rating Break Proximity
Water Storage & Delay (WS)	4.35	Moderate	LM	7.50	Higher	
Sediment Retention & Stabilization (SR)	3.12	Lower	LM	7.05	Higher	
Phosphorus Retention (PR)	2.52	Lower	LM	3.97	Moderate	LM
Nitrate Removal & Retention (NR)	2.88	Lower		10.00	Higher	
Anadromous Fish Habitat (FA)	0.00	Lower		0.00	Lower	
Resident Fish Habitat (FR)	0.00	Lower		0.00	Lower	
Amphibian & Reptile Habitat (AM)	8.03	Higher		2.38	Lower	
Waterbird Nesting Habitat (WBN)	7.90	Higher		1.72	Moderate	LM
Waterbird Feeding Habitat (WBF)	9.22	Higher		2.08	Lower	LM
Aquatic Invertebrate Habitat (INV)	4.77	Moderate	LM	1.08	Lower	
Songbird, Raptor, Mammal Habitat (SBM)	2.95	Lower		2.00	Lower	
Water Cooling (WC)	2.25	Lower	LM	0.77	Lower	
Native Plant Diversity (PD)	0.00	Lower		0.00	Lower	
Pollinator Habitat (POL)	5.05	Moderate		1.03	Lower	
Organic Nutrient Export (OE)	6.08	Moderate				
Carbon Sequestration (CS)	2.87	Lower				
Public Use & Recognition (PU)				1.88	Lower	

Other Attributes:	Score	Rating	Rating Break Proximity
Wetland Sensitivity (SEN)	4.33	Moderate	MH
Wetland Ecological Condition (EC)	1.51	Lower	
Wetland Stressors (STR)	3.33	Lower	LM

GROUPS	Selected Function	Function Rating	Rating Break Proximity	Values Rating	Rating Break Proximity
Hydrologic Function (WS)	Water Storage & Delay (WS)	Moderate	LM	Higher	
Water Quality Support (SR, PR, or NR)	Sediment Retention & Stabilization (SR)	Lower	LM	Higher	
Fish Habitat (FA or FR)	Anadromous Fish Habitat (FA)	Lower		Lower	
Aquatic Habitat (AM, WBF, or WBN)	Waterbird Nesting Habitat (WBN)	Higher		Moderate	LM
Ecosystem Support (WC, INV, PD, POL, SBM, or OE)	Organic Nutrient Export (OE)	Moderate		0.00	0.00

ORWAP Version 3.1. Cover Page: Basic Description of Assessment

Site Name:	Wetland PP Post Construction
Investigator Name:	Julie Fox
Date of Field Assessment:	
County:	Columbia
Nearest Town:	St. Helens
Latitude (decimal degrees):	
Longitude (decimal degrees):	
TRS, quarter/quarter section and tax lot(s):	
Approximate size of the Assessment Area (AA, in acres):	0.01 acre
AA as percent of entire wetland (approx.). Attach sketch map if AA is smaller than the entire contiguous wetland.	100%
If delineated, DSL file number (WD #) if known:	WD2019-0623
Cowardin Systems & Classes (indicate all present, based on field visit and/or aerial imagery): <u>Systems:</u> Palustrine =P, Riverine =R, Lacustrine =L, Estuarine =E <u>Classes:</u> Emergent =EM, Scrub-Shrub =SS, Forested =FO, Aquatic Bed (incl. SAV) =AB, Open Water =OW, Unconsolidated Bottom =UB, Unconsolidated Shore =US	PEMC
Predominant HGM Class: Estuarine=E, Lacustrine=L, Riverine=R, S= Slope, F= Flats, D= Depressional	Depressional Outflow
Soil Unit Mapped in Most of the AA:	Rock Outcrop-Xerumbrepts Complex, Undulating
If tidal, the tidal phase during most of visit:	
What percent (approximate) of the wetland were you able to visit?	100%
What percent (approximate) of the AA were you able to visit?	100%
Have you attended an ORWAP training session? If so, indicate approximate month & year.	
How many wetlands have you assessed previously using ORWAP (approximate)?	

Site Name:	Wetland PP Post Construction
Investigator Name:	Julie Fox
Date of Field Assessment:	
<i>Scores will appear below after data are entered in worksheets OF, F, T, and S. See Manual for definitions and descriptions of how scores were computed and ratings assigned.</i>	

<i>Normalized Scores & Ratings for this Assessment Area (AA):</i>						
Specific Functions or Values:	Function Score	Function Rating	Rating Break Proximity	Values Score	Values Rating	Rating Break Proximity
Water Storage & Delay (WS)	4.29	Moderate	LM	7.50	Higher	
Sediment Retention & Stabilization (SR)	3.06	Lower	LM	7.80	Higher	
Phosphorus Retention (PR)	2.43	Lower	LM	4.88	Moderate	
Nitrate Removal & Retention (NR)	2.30	Lower		10.00	Higher	
Anadromous Fish Habitat (FA)	0.00	Lower		0.00	Lower	
Resident Fish Habitat (FR)	0.00	Lower		0.00	Lower	
Amphibian & Reptile Habitat (AM)	7.87	Higher		1.11	Lower	
Waterbird Nesting Habitat (WBN)	0.00	Lower		0.00	Lower	
Waterbird Feeding Habitat (WBF)	0.00	Lower		0.00	Lower	
Aquatic Invertebrate Habitat (INV)	7.72	Higher		0.66	Lower	
Songbird, Raptor, Mammal Habitat (SBM)	2.59	Lower		2.00	Lower	
Water Cooling (WC)	2.25	Lower	LM	0.71	Lower	
Native Plant Diversity (PD)	6.54	Moderate	MH	10.00	Higher	
Pollinator Habitat (POL)	4.70	Moderate		1.03	Lower	
Organic Nutrient Export (OE)	7.47	Higher				
Carbon Sequestration (CS)	2.75	Lower				
Public Use & Recognition (PU)				1.88	Lower	

Other Attributes:	Score	Rating	Rating Break Proximity
Wetland Sensitivity (SEN)	4.43	Moderate	MH
Wetland Ecological Condition (EC)	0.72	Lower	
Wetland Stressors (STR)	3.33	Lower	LM

GROUPS	Selected Function	Function Rating	Rating Break Proximity	Values Rating	Rating Break Proximity
Hydrologic Function (WS)	Water Storage & Delay (WS)	Moderate	LM	Higher	
Water Quality Support (SR, PR, or NR)	Sediment Retention & Stabilization (SR)	Lower	LM	Higher	
Fish Habitat (FA or FR)	Anadromous Fish Habitat (FA)	Lower		Lower	
Aquatic Habitat (AM, WBF, or WBN)	Amphibian & Reptile Habitat (AM)	Higher		Lower	
Ecosystem Support (WC, INV, PD, POL, SBM, or OE)	Organic Nutrient Export (OE)	Higher		0.00	0.00

ORWAP Version 3.1. Cover Page: Basic Description of Assessment

Site Name:	Wetland M-1 Post Construction
Investigator Name:	Julie Fox
Date of Field Assessment:	
County:	Columbia
Nearest Town:	Saint Helens
Latitude (decimal degrees):	
Longitude (decimal degrees):	
TRS, quarter/quarter section and tax lot(s):	
Approximate size of the Assessment Area (AA, in acres):	8.9 acres
AA as percent of entire wetland (approx.). Attach sketch map if AA is smaller than the entire contiguous wetland.	100%
If delineated, DSL file number (WD #) if known:	N/A
Cowardin Systems & Classes (indicate all present, based on field visit and/or aerial imagery): <u>Systems:</u> Palustrine =P, Riverine =R, Lacustrine =L, Estuarine =E <u>Classes:</u> Emergent =EM, Scrub-Shrub =SS, Forested =FO, Aquatic Bed (incl. SAV) =AB, Open Water =OW, Unconsolidated Bottom =UB, Unconsolidated Shore =US	PFO/PSS/PEM
Predominant HGM Class: Estuarine=E, Lacustrine=L, Riverine=R, S= Slope, F= Flats, D= Depressional	Slope/Depressional Outflow
Soil Unit Mapped in Most of the AA:	Rock Outcrop-Xerumbrepts Complex, Undulating
If tidal, the tidal phase during most of visit:	
What percent (approximate) of the wetland were you able to visit?	100%
What percent (approximate) of the AA were you able to visit?	100%
Have you attended an ORWAP training session? If so, indicate approximate month & year.	
How many wetlands have you assessed previously using ORWAP (approximate)?	

Site Name:	Wetland M-1 Post Construction
Investigator Name:	Julie Fox
Date of Field Assessment:	
<i>Scores will appear below after data are entered in worksheets OF, F, T, and S. See Manual for definitions and descriptions of how scores were computed and ratings assigned.</i>	

<i>Normalized Scores & Ratings for this Assessment Area (AA):</i>						
Specific Functions or Values:	Function Score	Function Rating	Rating Break Proximity	Values Score	Values Rating	Rating Break Proximity
Water Storage & Delay (WS)	5.47	Moderate		7.50	Higher	
Sediment Retention & Stabilization (SR)	4.88	Moderate		7.52	Higher	
Phosphorus Retention (PR)	2.84	Lower	LM	4.67	Moderate	
Nitrate Removal & Retention (NR)	4.23	Moderate	LM	10.00	Higher	
Anadromous Fish Habitat (FA)	0.00	Lower		0.00	Lower	
Resident Fish Habitat (FR)	0.00	Lower		0.00	Lower	
Amphibian & Reptile Habitat (AM)	7.76	Higher		2.47	Lower	
Waterbird Nesting Habitat (WBN)	8.24	Higher		1.72	Moderate	LM
Waterbird Feeding Habitat (WBF)	9.87	Higher		2.08	Lower	LM
Aquatic Invertebrate Habitat (INV)	9.62	Higher		1.20	Lower	
Songbird, Raptor, Mammal Habitat (SBM)	5.58	Moderate	MH	2.00	Lower	
Water Cooling (WC)	4.20	Moderate		0.77	Lower	
Native Plant Diversity (PD)	8.85	Higher		10.00	Higher	
Pollinator Habitat (POL)	7.45	Higher	MH	1.03	Lower	
Organic Nutrient Export (OE)	6.99	Higher	MH			
Carbon Sequestration (CS)	4.92	Moderate				
Public Use & Recognition (PU)				3.76	Lower	LM

Other Attributes:	Score	Rating	Rating Break Proximity
Wetland Sensitivity (SEN)	6.30	Higher	
Wetland Ecological Condition (EC)	5.06	Moderate	MH
Wetland Stressors (STR)	3.33	Lower	LM

GROUPS	Selected Function	Function Rating	Rating Break Proximity	Values Rating	Rating Break Proximity
Hydrologic Function (WS)	Water Storage & Delay (WS)	Moderate		Higher	
Water Quality Support (SR, PR, or NR)	Sediment Retention & Stabilization (SR)	Moderate		Higher	
Fish Habitat (FA or FR)	Anadromous Fish Habitat (FA)	Lower		Lower	
Aquatic Habitat (AM, WBF, or WBN)	Waterbird Nesting Habitat (WBN)	Higher		Moderate	LM
Ecosystem Support (WC, INV, PD, POL, SBM, or OE)	Native Plant Diversity (PD)	Higher		Higher	

ORWAP Version 3.1. Cover Page: Basic Description of Assessment

Site Name:	Wetland M-2 Post Construction
Investigator Name:	Julie Fox
Date of Field Assessment:	
County:	Columbia
Nearest Town:	St. Helens
Latitude (decimal degrees):	
Longitude (decimal degrees):	
TRS, quarter/quarter section and tax lot(s):	
Approximate size of the Assessment Area (AA, in acres):	0.5 acres
AA as percent of entire wetland (approx.). Attach sketch map if AA is smaller than the entire contiguous wetland.	100%
If delineated, DSL file number (WD #) if known:	
Cowardin Systems & Classes (indicate all present, based on field visit and/or aerial imagery): <u>Systems:</u> Palustrine =P, Riverine =R, Lacustrine =L, Estuarine =E <u>Classes:</u> Emergent =EM, Scrub-Shrub =SS, Forested =FO, Aquatic Bed (incl. SAV) =AB, Open Water =OW, Unconsolidated Bottom =UB, Unconsolidated Shore =US	PFO/PSS/PEM
Predominant HGM Class: Estuarine=E, Lacustrine=L, Riverine=R, S= Slope, F= Flats, D= Depressional	Depressional
Soil Unit Mapped in Most of the AA:	Rock Outcrop-Xerumbrepts Complex, Undulating
If tidal, the tidal phase during most of visit:	
What percent (approximate) of the wetland were you able to visit?	
What percent (approximate) of the AA were you able to visit?	
Have you attended an ORWAP training session? If so, indicate approximate month & year.	
How many wetlands have you assessed previously using ORWAP (approximate)?	

Site Name:	Wetland M-2 Post Construction
Investigator Name:	Julie Fox
Date of Field Assessment:	
<i>Scores will appear below after data are entered in worksheets OF, F, T, and S. See Manual for definitions and descriptions of how scores were computed and ratings assigned.</i>	

<i>Normalized Scores & Ratings for this Assessment Area (AA):</i>						
Specific Functions or Values:	Function Score	Function Rating	Rating Break Proximity	Values Score	Values Rating	Rating Break Proximity
Water Storage & Delay (WS)	10.00	Higher		7.50	Higher	
Sediment Retention & Stabilization (SR)	10.00	Higher		7.17	Higher	
Phosphorus Retention (PR)	10.00	Higher		3.86	Moderate	LM
Nitrate Removal & Retention (NR)	10.00	Higher		10.00	Higher	
Anadromous Fish Habitat (FA)	0.00	Lower		0.00	Lower	
Resident Fish Habitat (FR)	0.00	Lower		0.00	Lower	
Amphibian & Reptile Habitat (AM)	7.60	Higher		2.39	Lower	
Waterbird Nesting Habitat (WBN)	6.76	Moderate	MH	2.83	Moderate	
Waterbird Feeding Habitat (WBF)	9.24	Higher		3.75	Moderate	
Aquatic Invertebrate Habitat (INV)	4.75	Moderate	LM	1.09	Lower	
Songbird, Raptor, Mammal Habitat (SBM)	3.64	Lower	LM	3.33	Lower	
Water Cooling (WC)	4.13	Moderate		0.00	Lower	
Native Plant Diversity (PD)	7.39	Higher	MH	1.89	Lower	
Pollinator Habitat (POL)	7.08	Higher	MH	1.03	Lower	
Organic Nutrient Export (OE)	0.00	Lower				
Carbon Sequestration (CS)	6.32	Higher	MH			
Public Use & Recognition (PU)				3.92	Lower	LM

Other Attributes:	Score	Rating	Rating Break Proximity
Wetland Sensitivity (SEN)	2.64	Moderate	LM
Wetland Ecological Condition (EC)	5.47	Higher	MH
Wetland Stressors (STR)	5.00	Moderate	

GROUPS	Selected Function	Function Rating	Rating Break Proximity	Values Rating	Rating Break Proximity
Hydrologic Function (WS)	Water Storage & Delay (WS)	Higher		Higher	
Water Quality Support (SR, PR, or NR)	Sediment Retention & Stabilization (SR)	Higher		Higher	
Fish Habitat (FA or FR)	Anadromous Fish Habitat (FA)	Lower		Lower	
Aquatic Habitat (AM, WBF, or WBN)	Waterbird Feeding Habitat (WBF)	Higher		Moderate	
Ecosystem Support (WC, INV, PD, POL, SBM, or OE)	Native Plant Diversity (PD)	Higher	MH	Lower	

ORWAP Version 3.1. Cover Page: Basic Description of Assessment

Site Name:	Wetland M-3 Post Construction
Investigator Name:	Julie Fox
Date of Field Assessment:	
County:	Columbia
Nearest Town:	St. Helens
Latitude (decimal degrees):	
Longitude (decimal degrees):	
TRS, quarter/quarter section and tax lot(s):	
Approximate size of the Assessment Area (AA, in acres):	7.63 acres
AA as percent of entire wetland (approx.). Attach sketch map if AA is smaller than the entire contiguous wetland.	100%
If delineated, DSL file number (WD #) if known:	
Cowardin Systems & Classes (indicate all present, based on field visit and/or aerial imagery): <u>Systems:</u> Palustrine =P, Riverine =R, Lacustrine =L, Estuarine =E <u>Classes:</u> Emergent =EM, Scrub-Shrub =SS, Forested =FO, Aquatic Bed (incl. SAV) =AB, Open Water =OW, Unconsolidated Bottom =UB, Unconsolidated Shore =US	PFO/PSS/PEM
Predominant HGM Class: Estuarine=E, Lacustrine=L, Riverine=R, S= Slope, F= Flats, D= Depressional	Slope/Depressional
Soil Unit Mapped in Most of the AA:	Rock Outcrop-Xerumbrepts Complex, Undulating
If tidal, the tidal phase during most of visit:	
What percent (approximate) of the wetland were you able to visit?	100%
What percent (approximate) of the AA were you able to visit?	100%
Have you attended an ORWAP training session? If so, indicate approximate month & year.	
How many wetlands have you assessed previously using ORWAP (approximate)?	

Site Name:	Wetland M-3 Post Construction
Investigator Name:	Julie Fox
Date of Field Assessment:	
<i>Scores will appear below after data are entered in worksheets OF, F, T, and S. See Manual for definitions and descriptions of how scores were computed and ratings assigned.</i>	

<i>Normalized Scores & Ratings for this Assessment Area (AA):</i>						
Specific Functions or Values:	Function Score	Function Rating	Rating Break Proximity	Values Score	Values Rating	Rating Break Proximity
Water Storage & Delay (WS)	10.00	Higher		7.50	Higher	
Sediment Retention & Stabilization (SR)	10.00	Higher		6.86	Higher	
Phosphorus Retention (PR)	10.00	Higher		3.61	Moderate	LM
Nitrate Removal & Retention (NR)	10.00	Higher		10.00	Higher	
Anadromous Fish Habitat (FA)	0.00	Lower		0.00	Lower	
Resident Fish Habitat (FR)	0.00	Lower		0.00	Lower	
Amphibian & Reptile Habitat (AM)	7.90	Higher		2.45	Lower	
Waterbird Nesting Habitat (WBN)	8.38	Higher		1.72	Moderate	LM
Waterbird Feeding Habitat (WBF)	9.72	Higher		2.08	Lower	LM
Aquatic Invertebrate Habitat (INV)	9.62	Higher		1.20	Lower	
Songbird, Raptor, Mammal Habitat (SBM)	5.39	Moderate	MH	2.00	Lower	
Water Cooling (WC)	9.59	Higher		0.00	Lower	
Native Plant Diversity (PD)	8.78	Higher		2.12	Lower	
Pollinator Habitat (POL)	7.14	Higher	MH	1.03	Lower	
Organic Nutrient Export (OE)	0.00	Lower				
Carbon Sequestration (CS)	6.25	Higher	MH			
Public Use & Recognition (PU)				3.75	Lower	LM

Other Attributes:	Score	Rating	Rating Break Proximity
Wetland Sensitivity (SEN)	2.70	Moderate	LM
Wetland Ecological Condition (EC)	5.26	Higher	MH
Wetland Stressors (STR)	5.00	Moderate	

GROUPS	Selected Function	Function Rating	Rating Break Proximity	Values Rating	Rating Break Proximity
Hydrologic Function (WS)	Water Storage & Delay (WS)	Higher		Higher	
Water Quality Support (SR, PR, or NR)	Sediment Retention & Stabilization (SR)	Higher		Higher	
Fish Habitat (FA or FR)	Anadromous Fish Habitat (FA)	Lower		Lower	
Aquatic Habitat (AM, WBF, or WBN)	Waterbird Nesting Habitat (WBN)	Higher		Moderate	LM
Ecosystem Support (WC, INV, PD, POL, SBM, or OE)	Aquatic Invertebrate Habitat (INV)	Higher		Lower	

ORWAP Version 3.1. Cover Page: Basic Description of Assessment

Site Name:	Wetlands M-4 through M-10 Post Construction
Investigator Name:	Julie Fox
Date of Field Assessment:	
County:	Columbia
Nearest Town:	St. Helens
Latitude (decimal degrees):	
Longitude (decimal degrees):	
TRS, quarter/quarter section and tax lot(s):	
Approximate size of the Assessment Area (AA, in acres):	1.3
AA as percent of entire wetland (approx.). Attach sketch map if AA is smaller than the entire contiguous wetland.	100%
If delineated, DSL file number (WD #) if known:	
Cowardin Systems & Classes (indicate all present, based on field visit and/or aerial imagery): Systems: Palustrine =P, Riverine =R, Lacustrine =L, Estuarine =E Classes: Emergent =EM, Scrub-Shrub =SS, Forested =FO, Aquatic Bed (incl. SAV) =AB, Open Water =OW, Unconsolidated Bottom =UB, Unconsolidated Shore =US	PEMC (ARSC)
Predominant HGM Class: Estuarine=E, Lacustrine=L, Riverine=R, S= Slope, F= Flats, D= Depressional	Depressional
Soil Unit Mapped in Most of the AA:	Rock Outcrop-Xerumbrepts Complex, Undulating
If tidal, the tidal phase during most of visit:	
What percent (approximate) of the wetland were you able to visit?	100%
What percent (approximate) of the AA were you able to visit?	100%
Have you attended an ORWAP training session? If so, indicate approximate month & year.	
How many wetlands have you assessed previously using ORWAP (approximate)?	

Site Name:	Wetlands M-4 through M-10 Post Construction
Investigator Name:	Julie Fox
Date of Field Assessment:	
<i>Scores will appear below after data are entered in worksheets OF, F, T, and S. See Manual for definitions and descriptions of how scores were computed and ratings assigned.</i>	

<i>Normalized Scores & Ratings for this Assessment Area (AA):</i>						
Specific Functions or Values:	Function Score	Function Rating	Rating Break Proximity	Values Score	Values Rating	Rating Break Proximity
Water Storage & Delay (WS)	10.00	Higher		7.50	Higher	
Sediment Retention & Stabilization (SR)	10.00	Higher		7.42	Higher	
Phosphorus Retention (PR)	10.00	Higher		4.21	Moderate	
Nitrate Removal & Retention (NR)	10.00	Higher		10.00	Higher	
Anadromous Fish Habitat (FA)	0.00	Lower		0.00	Lower	
Resident Fish Habitat (FR)	0.00	Lower		0.00	Lower	
Amphibian & Reptile Habitat (AM)	7.74	Higher		2.41	Lower	
Waterbird Nesting Habitat (WBN)	7.74	Higher		1.72	Moderate	LM
Waterbird Feeding Habitat (WBF)	9.41	Higher		2.08	Lower	LM
Aquatic Invertebrate Habitat (INV)	8.33	Higher		1.09	Lower	
Songbird, Raptor, Mammal Habitat (SBM)	3.29	Lower	LM	2.00	Lower	
Water Cooling (WC)	2.25	Lower	LM	0.00	Lower	
Native Plant Diversity (PD)	7.48	Higher	MH	10.00	Higher	
Pollinator Habitat (POL)	6.02	Moderate	MH	1.03	Lower	
Organic Nutrient Export (OE)	0.00	Lower				
Carbon Sequestration (CS)	3.80	Lower	LM			
Public Use & Recognition (PU)				3.82	Lower	LM

Other Attributes:	Score	Rating	Rating Break Proximity
Wetland Sensitivity (SEN)	5.56	Higher	
Wetland Ecological Condition (EC)	2.99	Moderate	LM
Wetland Stressors (STR)	5.00	Moderate	

GROUPS	Selected Function	Function Rating	Rating Break Proximity	Values Rating	Rating Break Proximity
Hydrologic Function (WS)	Water Storage & Delay (WS)	Higher		Higher	
Water Quality Support (SR, PR, or NR)	Sediment Retention & Stabilization (SR)	Higher		Higher	
Fish Habitat (FA or FR)	Anadromous Fish Habitat (FA)	Lower		Lower	
Aquatic Habitat (AM, WBF, or WBN)	Waterbird Nesting Habitat (WBN)	Higher		Moderate	LM
Ecosystem Support (WC, INV, PD, POL, SBM, or OE)	Native Plant Diversity (PD)	Higher	MH	Higher	

Appendix D

Pre-Project Stream Functions and Values Assessment Forms

STREAM FUNCTION ASSESSMENT METHOD for OREGON

Version 1.0 (June 2018)

Name of Project Area: Intermittent Stream B	Date of Field Assessment: 6/11/2020	Latitude*: 45.8689 N
Data Collector: Julie Fox	Elevation: 202 ft <small>(SFAM Report)</small>	Longitude*: -122.8199 W <small>* near center of the project site</small>
Project Number:	Project Area Length (feet): 530	Project Area (acres): 0.05
Photo Numbers:		

What is the Oregon Stream Classification for the project area? Select from drop-down menu. Refer to the SFAM Report. If the project area spans more than one reach, describe the dominant stream classification. Not Classified

What ratings does the Oregon Stream Classification identify for the following measures in the local hydrologic unit? Refer to the SFAM Report. If project area spans more than one reach, describe the dominant classification:

Aquifer Permeability (local)	Low	Soil Permeability (local)	Low	<small>*If EPA Classification is different from the gradient you observe in the local reach, select the gradient in the local reach.</small>
Erodibility (local)	Moderately Erodible	Gradient*	2-6%	

Is the channel perennial, intermittent, or ephemeral? (Map Viewer-NHD Flowline)	Intermittent	
Which Level III EPA Ecoregion is the site located in? (SFAM Report)	Willamette Valley	Western Mountains
Is the average width of the stream less than or greater than 50 feet? (User Input)	≤ 50 feet	Small
What is the 2 year peak flow (cfs)? (StreamStats Report)	6.53	
What is the size of the drainage area (mi²)? (StreamStats Report)	0.18	

External Data: List below the persons and/or agencies that provided location information on rare wildlife species, and/or rare plants, and the date the information was gathered (if known).
Oregon Biodiversity Information Center (ORBIC) Report, Institute for Natural Resources, Portland State University, 11/22/2019.

Project Area History: Based on conversation with landowner/manager and other information, describe below the years and extent (% of project area) of past and present management actions (e.g., vegetation control), natural disturbances (e.g., fire, insect infestations), and human-associated disturbances (e.g., grazing regimes).
Portions of project area impacted by vehicular traffic associated with past logging activities.

Assessment Notes: Note any special features of the reach or landscape, problems with scoring, or other information that may be relevant.
Stream partially contained in Wetland M.

STREAM ASSESSMENT SCORES SHEET

version 1.0

Project Area Name:	Intermittent Stream B		
Investigator Name:	Julie Fox		
Date of Field Assessment:	6/11/2020		
Latitude (decimal degrees):	45.8689 N	Longitude (decimal degrees):	-122.8199 W

SPECIFIC FUNCTIONS	Function Score	Function Rating	Value Score	Value Rating
Surface Water Storage (SWS)	5.29	Moderate	5.83	Moderate
Sub/Surface Water Transfer (SST)	6.56	Moderate	10.00	Higher
Flow Variation (FV)	8.75	Higher	8.33	Higher
Sediment Continuity (SC)	6.59	Moderate	2.00	Lower
Sediment Mobility (SM)	8.50	Higher	5.00	Moderate
Maintain Biodiversity (MB)	2.26	Lower	4.00	Moderate
Create and Maintain Habitat (CMH)	2.04	Lower	6.67	Moderate
Sustain Trophic Structure (STS)	7.06	Higher	5.11	Moderate
Nutrient Cycling (NC)	7.08	Higher	2.50	Lower
Chemical Regulation (CR)	7.58	Higher	2.50	Lower
Thermal Regulation (TR)	5.10	Moderate	7.17	Higher

GROUPED FUNCTIONS	REPRESENTATIVE FUNCTION	Function Group Rating	Value Group Rating
Hydrologic Function (SWS, SST, FV)	Flow Variation (FV)	Higher	Higher
Geomorphic Function (SC, SM)	Sediment Mobility (SM)	Higher	Moderate
Biologic Function (MB, CMH, STS)	Sustain Trophic Structure (STS)	Higher	Moderate
Water Quality Function (NC, CR, TR)	Chemical Regulation (CR)	Higher	Lower

Formulas for each specific function and value (shown on Subscores tab) produce a numerical score between 0.0 and 10.0. For ecological functions, a score of 0.0 indicates that negligible function is being provided by the stream whereas a score of 10.0 indicates that the stream is providing maximum function (as defined) given certain contextual factors. For values, a score of 0.0 indicates that there is low opportunity for the site to provide a specific ecological function and that, even if it did, the specific function would not be of particular significance given the context of the site. Conversely, a value score or 10.0 indicates that a site has the opportunity to provide a specific function and that it would be highly significant in that particular location. For all function and value formulas, both extents of the scoring range (0.0 and 10.0) are mathematically possible.

To facilitate conceptual understanding, numerical scores are translated into ratings of Lower, Moderate, or Higher. The numerical thresholds for each of these rating categories are consistent across all functions and values such that scores of <3.0 are rated "Lower," scores ≥3.0 but ≤7.0 are rated "Moderate," and scores that are >7.0 are rated "Higher." These thresholds are consistent with the standard scoring scheme applied to all individual measures.

Each specific function, and its associated value, is included in one of four thematic groups: hydrologic, geomorphic, biologic, and water quality functions. Group ratings provide an indication of the degree to which each group of processes is present at a site. Groups are represented by the highest-rated function with the highest-rated associated value among the 2-3 functions that comprise each group. This hierarchical selection system ensures that thematic functional groups are represented by the highest-performing and highest-valued ecological function.

STREAM FUNCTION ASSESSMENT METHOD for OREGON

Version 1.0 (June 2018)

Name of Project Area:	Trib to Intermittent Stream B	Date of Field Assessment:	6/11/2020	Latitude*:	45.8691 N
Data Collector:	Julie Fox	Elevation: (SFAM Report)	200 ft	Longitude*:	-122.8196 W
Project Number:		Project Area Length (feet):	170	Project Area (acres):	0.01
Photo Numbers:					

* near center of the project site

What is the Oregon Stream Classification for the project area? Select from drop-down menu. Refer to the SFAM Report. If the project area spans more than one reach, describe the dominant stream classification.

Not Classified

What ratings does the Oregon Stream Classification identify for the following measures in the local hydrologic unit? Refer to the SFAM Report. If project area spans more than one reach, describe the dominant classification:

Aquifer Permeability (local)	Low	Soil Permeability (local)	Low	*If EPA Classification is different from the gradient you observe in the local reach, select the gradient in the local reach.
Erodibility (local)	Difficult to Erode	Gradient*	2-6%	

Is the channel perennial, intermittent, or ephemeral? (Map Viewer-NHD Flowline)	Intermittent	
Which Level III EPA Ecoregion is the site located in? (SFAM Report)	Willamette Valley	Western Mountains
Is the average width of the stream less than or greater than 50 feet? (User Input)	≤ 50 feet	Small
What is the 2 year peak flow (cfs)? (StreamStats Report)	6.53	
What is the size of the drainage area (mi²)? (StreamStats Report)	0.18	

External Data: List below the persons and/or agencies that provided location information on rare wildlife species, and/or rare plants, and the date the information was gathered (if known).

Oregon Biodiversity Information Center (ORBIC) Report, Institute for Natural Resources, Portland State University, 11/22/2019.

Project Area History: Based on conversation with landowner/manager and other information, describe below the years and extent (% of project area) of past and present management actions (e.g., vegetation control), natural disturbances (e.g., fire, insect infestations), and human-associated disturbances (e.g., grazing regimes).

Portions of project area impacted by vehicular traffic associated with past logging activities.

Assessment Notes: Note any special features of the reach or landscape, problems with scoring, or other information that may be relevant.

Stream partially contained in Wetland M and drains into Intermittent Stream B.

STREAM ASSESSMENT SCORES SHEET

version 1.0

Project Area Name:	Trib to Intermittent Stream B		
Investigator Name:	Julie Fox		
Date of Field Assessment:	6/11/2020		
Latitude (decimal degrees):	45.8691 N	Longitude (decimal degrees):	-122.8196 W

SPECIFIC FUNCTIONS	Function Score	Function Rating	Value Score	Value Rating
Surface Water Storage (SWS)	4.44	Moderate	5.83	Moderate
Sub/Surface Water Transfer (SST)	5.41	Moderate	10.00	Higher
Flow Variation (FV)	7.21	Higher	8.33	Higher
Sediment Continuity (SC)	8.55	Higher	3.25	Moderate
Sediment Mobility (SM)	6.66	Moderate	5.00	Moderate
Maintain Biodiversity (MB)	1.98	Lower	4.00	Moderate
Create and Maintain Habitat (CMH)	1.67	Lower	6.67	Moderate
Sustain Trophic Structure (STS)	5.77	Moderate	5.11	Moderate
Nutrient Cycling (NC)	5.14	Moderate	2.50	Lower
Chemical Regulation (CR)	6.42	Moderate	2.50	Lower
Thermal Regulation (TR)	0.00	Lower	7.17	Higher

GROUPED FUNCTIONS	REPRESENTATIVE FUNCTION	Function Group Rating	Value Group Rating
Hydrologic Function (SWS, SST, FV)	Flow Variation (FV)	Higher	Higher
Geomorphic Function (SC, SM)	Sediment Continuity (SC)	Higher	Moderate
Biologic Function (MB, CMH, STS)	Sustain Trophic Structure (STS)	Moderate	Moderate
Water Quality Function (NC, CR, TR)	Chemical Regulation (CR)	Moderate	Lower

Formulas for each specific function and value (shown on Subscores tab) produce a numerical score between 0.0 and 10.0. For ecological functions, a score of 0.0 indicates that negligible function is being provided by the stream whereas a score of 10.0 indicates that the stream is providing maximum function (as defined) given certain contextual factors. For values, a score of 0.0 indicates that there is low opportunity for the site to provide a specific ecological function and that, even if it did, the specific function would not be of particular significance given the context of the site. Conversely, a value score or 10.0 indicates that a site has the opportunity to provide a specific function and that it would be highly significant in that particular location. For all function and value formulas, both extents of the scoring range (0.0 and 10.0) are mathematically possible.

To facilitate conceptual understanding, numerical scores are translated into ratings of Lower, Moderate, or Higher. The numerical thresholds for each of these rating categories are consistent across all functions and values such that scores of <3.0 are rated "Lower," scores ≥3.0 but ≤7.0 are rated "Moderate," and scores that are >7.0 are rated "Higher." These thresholds are consistent with the standard scoring scheme applied to all individual measures.

Each specific function, and its associated value, is included in one of four thematic groups: hydrologic, geomorphic, biologic, and water quality functions. Group ratings provide an indication of the degree to which each group of processes is present at a site. Groups are represented by the highest-rated function with the highest-rated associated value among the 2-3 functions that comprise each group. This hierarchical selection system ensures that thematic functional groups are represented by the highest-performing and highest-valued ecological function.

STREAM FUNCTION ASSESSMENT METHOD for OREGON

Version 1.0 (June 2018)

Name of Project Area: Intermittent Stream D

Date of Field Assessment: 6/11/2020

Latitude*: 45.8702 N

Data Collector: Julie Fox

Elevation: 182 ft
(SFAM Report)

Longitude*: -122.8179 W

* near center of the project site

Project Number:

Project Area Length (feet): 35

Project Area (acres): 0.00

Photo Numbers:

What is the Oregon Stream Classification for the project area? Select from drop-down menu. Refer to the SFAM Report. If the project area spans more than one reach, describe the dominant stream classification. Not Classified

What ratings does the Oregon Stream Classification identify for the following measures in the local hydrologic unit? Refer to the SFAM Report. If project area spans more than one reach, describe the dominant classification:

Aquifer Permeability (local)	Low	Soil Permeability (local)	Low	<small>*If EPA Classification is different from the gradient you observe in the local reach, select the gradient in the local reach.</small>
Erodibility (local)	Difficult to Erode	Gradient*	> 6%	

Is the channel perennial, intermittent, or ephemeral? (Map Viewer-NHD Flowline)	Intermittent	
Which Level III EPA Ecoregion is the site located in? (SFAM Report)	Willamette Valley	Western Mountains
Is the average width of the stream less than or greater than 50 feet? (User Input)	≤ 50 feet	Small
What is the 2 year peak flow (cfs)? (StreamStats Report)	1.35	
What is the size of the drainage area (mi ²)? (StreamStats Report)	0.0354	

External Data: List below the persons and/or agencies that provided location information on rare wildlife species, and/or rare plants, and the date the information was gathered (if known).

Oregon Biodiversity Information Center (ORBIC) Report, Institute for Natural Resources, Portland State University, 11/22/2019.

Project Area History: Based on conversation with landowner/manager and other information, describe below the years and extent (% of project area) of past and present management actions (e.g., vegetation control), natural disturbances (e.g., fire, insect infestations), and human-associated disturbances (e.g., grazing regimes).

Assessment Notes: Note any special features of the reach or landscape, problems with scoring, or other information that may be relevant.

Stream located on steep bedrock slope and entirely surrounded by uplands.

STREAM ASSESSMENT SCORES SHEET

version 1.0

Project Area Name:	Intermittent Stream D		
Investigator Name:	Julie Fox		
Date of Field Assessment:	6/11/2020		
Latitude (decimal degrees):	45.8702 N	Longitude (decimal degrees):	-122.8179 W

SPECIFIC FUNCTIONS	Function Score	Function Rating	Value Score	Value Rating
Surface Water Storage (SWS)	5.00	Moderate	7.58	Higher
Sub/Surface Water Transfer (SST)	2.50	Lower	10.00	Higher
Flow Variation (FV)	6.67	Moderate	9.50	Higher
Sediment Continuity (SC)	10.00	Higher	3.48	Moderate
Sediment Mobility (SM)	6.00	Moderate	6.75	Moderate
Maintain Biodiversity (MB)	2.00	Lower	4.00	Moderate
Create and Maintain Habitat (CMH)	2.67	Lower	5.97	Moderate
Sustain Trophic Structure (STS)	5.44	Moderate	4.61	Moderate
Nutrient Cycling (NC)	3.83	Moderate	2.64	Lower
Chemical Regulation (CR)	3.51	Moderate	2.64	Lower
Thermal Regulation (TR)	5.10	Moderate	7.40	Higher

GROUPED FUNCTIONS	REPRESENTATIVE FUNCTION	Function Group Rating	Value Group Rating
Hydrologic Function (SWS, SST, FV)	Flow Variation (FV)	Moderate	Higher
Geomorphic Function (SC, SM)	Sediment Continuity (SC)	Higher	Moderate
Biologic Function (MB, CMH, STS)	Sustain Trophic Structure (STS)	Moderate	Moderate
Water Quality Function (NC, CR, TR)	Thermal Regulation (TR)	Moderate	Higher

Formulas for each specific function and value (shown on Subscores tab) produce a numerical score between 0.0 and 10.0. For ecological functions, a score of 0.0 indicates that negligible function is being provided by the stream whereas a score of 10.0 indicates that the stream is providing maximum function (as defined) given certain contextual factors. For values, a score of 0.0 indicates that there is low opportunity for the site to provide a specific ecological function and that, even if it did, the specific function would not be of particular significance given the context of the site. Conversely, a value score or 10.0 indicates that a site has the opportunity to provide a specific function and that it would be highly significant in that particular location. For all function and value formulas, both extents of the scoring range (0.0 and 10.0) are mathematically possible.

To facilitate conceptual understanding, numerical scores are translated into ratings of Lower, Moderate, or Higher. The numerical thresholds for each of these rating categories are consistent across all functions and values such that scores of <3.0 are rated "Lower," scores ≥3.0 but ≤7.0 are rated "Moderate," and scores that are >7.0 are rated "Higher." These thresholds are consistent with the standard scoring scheme applied to all individual measures.

Each specific function, and its associated value, is included in one of four thematic groups: hydrologic, geomorphic, biologic, and water quality functions. Group ratings provide an indication of the degree to which each group of processes is present at a site. Groups are represented by the highest-rated function with the highest-rated associated value among the 2-3 functions that comprise each group. This hierarchical selection system ensures that thematic functional groups are represented by the highest-performing and highest-valued ecological function.

STREAM FUNCTION ASSESSMENT METHOD for OREGON

Version 1.0 (June 2018)

Name of Project Area: Perennial Stream 1-A	Date of Field Assessment: 3/4/2021	Latitude*: 45.8745
Data Collector: Julie Fox	Elevation: 273 ft <small>(SFAM Report)</small>	Longitude*: -122.8224 <small>* near center of the project site</small>
Project Number:	Project Area Length (feet): 235	Project Area (acres): 0.01
Photo Numbers:		

What is the Oregon Stream Classification for the project area? Select from drop-down menu. Refer to the SFAM Report. If the project area spans more than one reach, describe the dominant stream classification. Not Classified

What ratings does the Oregon Stream Classification identify for the following measures in the local hydrologic unit? Refer to the SFAM Report. If project area spans more than one reach, describe the dominant classification:

Aquifer Permeability (local)	Low	Soil Permeability (local)	Low	<small>*If EPA Classification is different from the gradient you observe in the local reach, select the gradient in the local reach.</small>
Erodibility (local)	Moderately Erodible	Gradient*	2-6%	

Is the channel perennial, intermittent, or ephemeral? (Map Viewer-NHD Flowline)	Perennial	
Which Level III EPA Ecoregion is the site located in? (SFAM Report)	Willamette Valley	Western Mountains
Is the average width of the stream less than or greater than 50 feet? (User Input)	≤ 50 feet	Small
What is the 2 year peak flow (cfs)? (StreamStats Report)	3.3	
What is the size of the drainage area (mi²)? (StreamStats Report)	0.0782	

External Data: List below the persons and/or agencies that provided location information on rare wildlife species, and/or rare plants, and the date the information was gathered (if known).
Oregon Biodiversity Information Center (ORBIC) Report, Institute for Natural Resources, Portland State University, 11/22/2019.

Project Area History: Based on conversation with landowner/manager and other information, describe below the years and extent (% of project area) of past and present management actions (e.g., vegetation control), natural disturbances (e.g., fire, insect infestations), and human-associated disturbances (e.g., grazing regimes).
Project area adjacent to rural road (Liberty Hill Road) and receives hydrology from upstream drainage via culvert under road.

Assessment Notes: Note any special features of the reach or landscape, problems with scoring, or other information that may be relevant.
Stream partially contained in Wetland A. Assessment performed on entire stream eventhough no direct impacts to Perennial Stream 1-A are proposed by the project..

STREAM ASSESSMENT SCORES SHEET

version 1.0

Project Area Name:	Perennial Stream 1-A		
Investigator Name:	Julie Fox		
Date of Field Assessment:	3/4/2021		
Latitude (decimal degrees):	45.8745	Longitude (decimal degrees):	-122.8224

SPECIFIC FUNCTIONS	Function Score	Function Rating	Value Score	Value Rating
Surface Water Storage (SWS)	6.36	Moderate	5.83	Moderate
Sub/Surface Water Transfer (SST)	8.25	Higher	10.00	Higher
Flow Variation (FV)	8.34	Higher	8.33	Higher
Sediment Continuity (SC)	7.73	Higher	2.00	Lower
Sediment Mobility (SM)	8.39	Higher	6.25	Moderate
Maintain Biodiversity (MB)	2.26	Lower	5.67	Moderate
Create and Maintain Habitat (CMH)	3.02	Moderate	8.33	Higher
Sustain Trophic Structure (STS)	6.08	Moderate	6.36	Moderate
Nutrient Cycling (NC)	7.23	Higher	2.50	Lower
Chemical Regulation (CR)	8.24	Higher	2.50	Lower
Thermal Regulation (TR)	3.22	Moderate	9.67	Higher

GROUPED FUNCTIONS	REPRESENTATIVE FUNCTION	Function Group Rating	Value Group Rating
Hydrologic Function (SWS, SST, FV)	Flow Variation (FV)	Higher	Higher
Geomorphic Function (SC, SM)	Sediment Mobility (SM)	Higher	Moderate
Biologic Function (MB, CMH, STS)	Sustain Trophic Structure (STS)	Moderate	Moderate
Water Quality Function (NC, CR, TR)	Chemical Regulation (CR)	Higher	Lower

Formulas for each specific function and value (shown on Subscores tab) produce a numerical score between 0.0 and 10.0. For ecological functions, a score of 0.0 indicates that negligible function is being provided by the stream whereas a score of 10.0 indicates that the stream is providing maximum function (as defined) given certain contextual factors. For values, a score of 0.0 indicates that there is low opportunity for the site to provide a specific ecological function and that, even if it did, the specific function would not be of particular significance given the context of the site. Conversely, a value score or 10.0 indicates that a site has the opportunity to provide a specific function and that it would be highly significant in that particular location. For all function and value formulas, both extents of the scoring range (0.0 and 10.0) are mathematically possible.

To facilitate conceptual understanding, numerical scores are translated into ratings of Lower, Moderate, or Higher. The numerical thresholds for each of these rating categories are consistent across all functions and values such that scores of <3.0 are rated "Lower," scores ≥3.0 but ≤7.0 are rated "Moderate," and scores that are >7.0 are rated "Higher." These thresholds are consistent with the standard scoring scheme applied to all individual measures.

Each specific function, and its associated value, is included in one of four thematic groups: hydrologic, geomorphic, biologic, and water quality functions. Group ratings provide an indication of the degree to which each group of processes is present at a site. Groups are represented by the highest-rated function with the highest-rated associated value among the 2-3 functions that comprise each group. This hierarchical selection system ensures that thematic functional groups are represented by the highest-performing and highest-valued ecological function.

Appendix E

Pre-Project SFAM Reports



Intermittent Stream B
Stream Function Assessment Method (SFAM)
Report



Report Generated: October 29, 2020 10:55 AM

Location Information

Latitude	45.8689 N	Longitude	-122.8199 W
Elevation	202 ft	Level III Ecoregion	Willamette Valley
HUC8	17080003 Lower Columbia-Clatskanie		
HUC10	1708000304 Beaver Creek-Frontal Columbia River		
HUC12	170800030401 Deer Island Slough-Frontal Columbia River		
Linear ft of stream in HUC8	216,535	Annual precipitation	44 in

Stream Type and Classifications

No results

Stream classifications and associated attributes are derived from a U.S. Environmental Protection Agency stream classification geospatial data layer developed for Oregon (2015). This layer provides a statewide stream/watershed classification system for streams and rivers of various sizes, based in part on a hydrologic landscape classification system.

Report Generated: October 29, 2020 10:55 AM

Rare Species Scores and Special Habitat Designations

Rare Species Type	Maximum score	Sum Score	Rating
Non-anadromous Fish Species	0	0	None
Amphibian & Reptile Species	0	0	None
Feeding Waterbirds	0	0	None
Songbirds, Raptors, and Mammals	0	0	None
Invertebrate Species	0	0	None
Plant Species	0	0	None

Scores have taken into account several factors for each rare species record contained in the official database of the Oregon Biodiversity Information Center (ORBIC): (a) the regional rarity of the species, (b) their proximity to the point of interest, and (c) the "certainty" that ORBIC assigns to each of those records.

Within 300 ft of a Special Protected Area?	No
Within a HUC12 that has designated Essential Salmonid Habitat?	Yes
Within 2 miles of an Important Bird Area?	No

Water Quality Impairments

Query returned no records.

Water quality information is derived from Oregon's 2012 Integrated Report, including the list of water quality limited waters needing Total Maximum Daily Loads (303d List). Each record in the report is assigned an assessment category based on an evaluation of water quality information. Categories included in the SFAM Report are:

Category 5: Water is water quality limited and a TMDL is needed; Section 303(d) list.

Category 4: Water is impaired or threatened but a TMDL is not needed because: (A) the TMDL is approved, (B) other pollution requirements are in place, or (C) the impairment (such as flow or lack of flow)

Report Generated: October 29, 2020 10:55 AM

is not caused by a pollutant.

Category 3B: Water quality is of potential concern; some data indicate non-attainment of a criterion, but data are insufficient to assign another category.

Dominant soil type(s)			
Soil Type	Erosion Hazard Rating	Hydric Rating	Percent Area
Rock outcrop-Xerumbrepts complex, undulating	Not rated	No	100.00%

This report contains both centroid-based and polygon-based data. The Location Information section of the report contains centroid-based data (determined by the center point of the polygon), while the remaining sections are polygon-based (determined from the entire polygon).

Intermittent Stream B

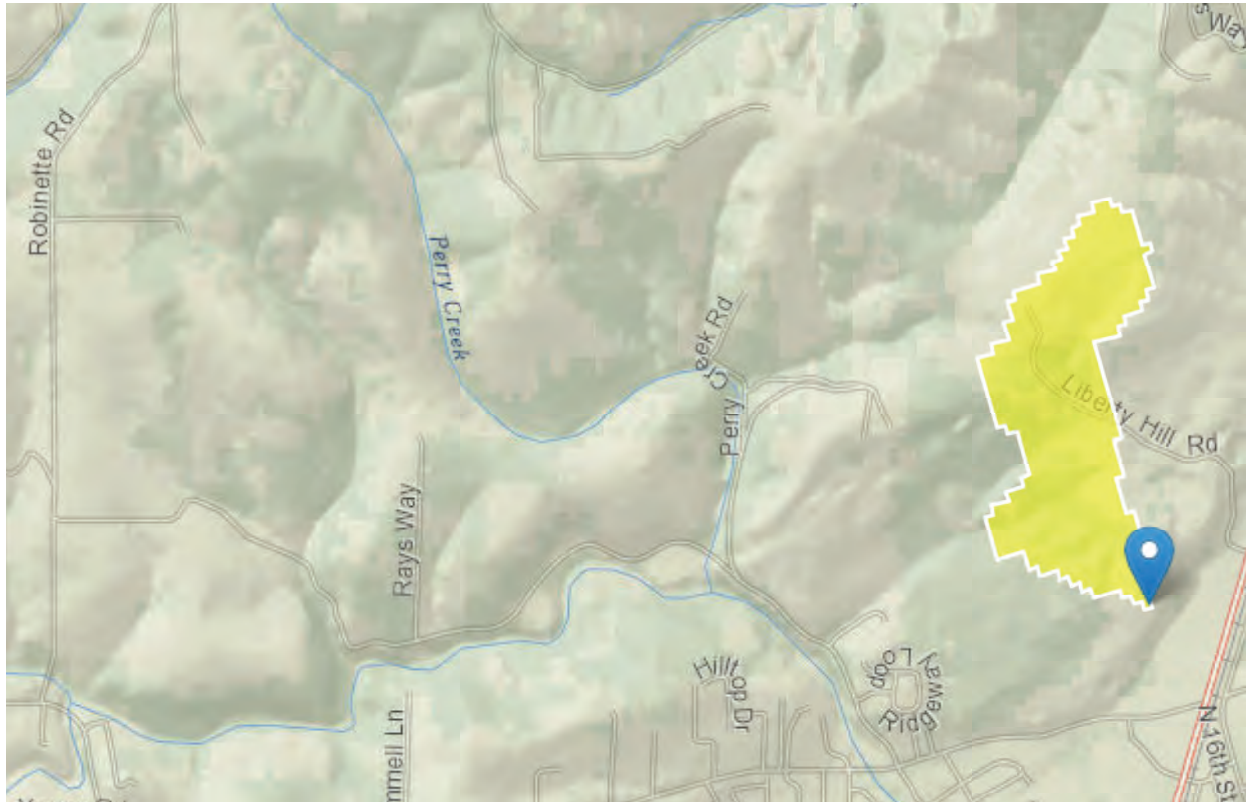
StreamStats Report

Region ID: OR

Workspace ID: OR20201029175809648000

Clicked Point (Latitude, Longitude): 45.86888, -122.81979

Time: 2020-10-29 10:58:27 -0700



Basin Characteristics

Parameter Code	Parameter Description	Value	Unit
DRNAREA	Area that drains to a point on a stream	0.18	square miles
I24H2Y	Maximum 24-hour precipitation that occurs on average once in 2 years - Equivalent to precipitation intensity index	1.77	inches
SOILPERM	Average Soil Permeability	2.2	inches per hour

Parameter Code	Parameter Description	Value	Unit
JANMAXT2K	Mean Maximum January Temperature from 2K resolution PRISM 1961-1990 data	45.1	degrees F
WATCAPORC	Available water capacity from STATSGO data using methods from SIR 2005-5116	0.11	inches
ORREG2	Oregon Region Number	10001	dimensionless
BSLOPD	Mean basin slope measured in degrees	4.68	degrees
JANMINT2K	Mean Minimum January Temperature from 2K resolution PRISM PRISM 1961-1990 data	32.3	degrees F
ELEV	Mean Basin Elevation	326	feet
PRECIP	Mean Annual Precipitation	48.6	inches
WATCAPORR	Available water capacity from STATSGO data using methods from SIR 2008-5126	0.11	inch per inch
JANMINTMP	Mean Minimum January Temperature	32.3	degrees F
IMPERV	Percentage of impervious area	8.15	percent
MINBELEV	Minimum basin elevation	198	feet
MAXBSLOPD	Maximum basin slope, in degrees, using ArcInfo Grid with NHDPlus 30-m resolution elevation data.	14.5	degrees
ASPECT	basin average of topographic slope compass directions from elevation grid	160	degrees
DRNDENSITY	Basin drainage density defined as total stream length divided by drainage area.	0	dimensionless
ELEVMAX	Maximum basin elevation	447	feet
FOREST	Percentage of area covered by forest	75	percent
JANMAXTMP	Mean Maximum January Temperature	44.7	degrees F
JANAVPRE2K	Mean January Precipitation	6.96	inches
JULAVPRE2K	Mean July Average Precipitation	0.64	inches
LC11BARE	Percentage of barren from NLCD 2011 class 31	0	percent

Parameter Code	Parameter Description	Value	Unit
LC11CRPHAY	Percentage of cultivated crops and hay, classes 81 and 82, from NLCD 2011	33	percent
LC11DEVHI	Percentage of area developed, high intensity, NLCD 2011 class 24	0	percent
LC11DVLO	Percentage of developed area, low intensity, from NLCD 2011 class 22	0	percent
LC11DVMD	Percentage of area developed, medium intensity, NLCD 2011 class 23	0	percent
LC11DVOPN	Percentage of developed open area from NLCD 2011 class 21	5	percent
LC11FORSHB	Percentage of forests and shrub lands, classes 41 to 52, from NLCD 2011	62	percent
LC11HERB	Percentage of herbaceous from NLCD 2011 classes 71-74	0	percent
LC11IMP	Average percentage of impervious area determined from NLCD 2011 impervious dataset	0.5	percent
LC11WATER	Percent of open water, class 11, from NLCD 2011	0	percent
LC11WETLND	Percentage of wetlands, classes 90 and 95, from NLCD 2011	0	percent
MAJ_ROADS	Length of non-state major roads in basin	0	miles
MAXTEMP	Mean annual maximum air temperature over basin area from PRISM 1971-2000 800-m grid	61.6	degrees F
MINBSLOPD	Minimum basin slope, in degrees, using ArcInfo Grid with NHDPlus 30-m resolution elevation data.	0.0272	degrees
MINTEMP	Mean annual minimum air temperature over basin surface area as defined in SIR 2008-5126	41.6	degrees F
MIN_ROADS	Length of non-state minor roads in basin	0.32	miles

Parameter Code	Parameter Description	Value	Unit
OR_HIPERMA	Percent basin surface area containing high permeability aquifer units as defined in SIR 2008-5126	0	percent
OR_HIPERMG	Percent basin surface area containing high permeability geologic units as defined in SIR 2008-5126	0	percent
RELIEF	Maximum - minimum elevation	249	feet
STATE_HWY	Length of state highways in basin	0	miles
STATSGODEP	Area-weighted average soil depth from NRCS STATSGO database	45	inches
STRMTOT	total length of all mapped streams (1:24,000-scale) in the basin	0	miles

Peak-Flow Statistics Parameters^[Reg 2B Western Interior LT 3000 ft Cooper]

Parameter Code	Parameter Name	Value	Units	Min Limit	Max Limit
DRNAREA	Drainage Area	0.18	square miles	0.37	7270
BSLOPD	Mean Basin Slope degrees	4.68	degrees	5.62	28.3
I24H2Y	24 Hour 2 Year Precipitation	1.77	inches	1.53	4.48
ELEV	Mean Basin Elevation	326	feet		
ORREG2	Oregon Region Number	10001	dimensionless		

Peak-Flow Statistics Disclaimers^[Reg 2B Western Interior LT 3000 ft Cooper]

One or more of the parameters is outside the suggested range. Estimates were extrapolated with unknown errors

Peak-Flow Statistics Flow Report^[Reg 2B Western Interior LT 3000 ft Cooper]

Statistic	Value	Unit
-----------	-------	------

Statistic	Value	Unit
2 Year Peak Flood	6.53	ft ³ /s
5 Year Peak Flood	9.75	ft ³ /s
10 Year Peak Flood	12	ft ³ /s
25 Year Peak Flood	14.8	ft ³ /s
50 Year Peak Flood	17	ft ³ /s
100 Year Peak Flood	19.1	ft ³ /s
500 Year Peak Flood	24.1	ft ³ /s

Peak-Flow Statistics Citations

Cooper, R.M.,2005, Estimation of Peak Discharges for Rural, Unregulated Streams in Western Oregon: U.S. Geological Survey Scientific Investigations Report 2005-5116, 76 p. (<http://pubs.usgs.gov/sir/2005/5116/pdf/sir2005-5116.pdf>)

Low-Flow Statistics Parameters[100 Percent (0.181 square miles) LowFlow Ann Region01 2008 5126]

Parameter Code	Parameter Name	Value	Units	Min Limit	Max Limit
DRNAREA	Drainage Area	0.18	square miles	0.367	590.347
PRECIP	Mean Annual Precipitation	48.6	inches	65.5923	122.984
WATCAPORR	Available_Water_Capacity_OR_Risley	0.11	inch per inch	0.12	0.23

Low-Flow Statistics Disclaimers[100 Percent (0.181 square miles) LowFlow Ann Region01 2008 5126]

One or more of the parameters is outside the suggested range. Estimates were extrapolated with unknown errors

Low-Flow Statistics Flow Report[100 Percent (0.181 square miles) LowFlow Ann Region01 2008 5126]

Statistic	Value	Unit
7 Day 2 Year Low Flow	0.00904	ft ³ /s

Statistic	Value	Unit
7 Day 10 Year Low Flow	0.00449	ft ³ /s

Low-Flow Statistics Citations

Risley, John, Stonewall, Adam, and Haluska, Tana, 2008, Estimating flow-duration and low-flow frequency statistics for unregulated streams in Oregon: U.S. Geological Survey Scientific Investigations Report 2008-5126, 22 p. (<http://pubs.usgs.gov/sir/2008/5126/>)

Flow-Duration Statistics Parameters[100 Percent (0.181 square miles) LowFlow Ann Region01 2008 5126]

Parameter Code	Parameter Name	Value	Units	Min Limit	Max Limit
DRNAREA	Drainage Area	0.18	square miles	0.367	590.347
PRECIP	Mean Annual Precipitation	48.6	inches	65.5923	122.984
WATCAPORR	Available_Water_Capacity_OR_Risley	0.11	inch per inch	0.12	0.23

Flow-Duration Statistics Disclaimers[100 Percent (0.181 square miles) LowFlow Ann Region01 2008 5126]

One or more of the parameters is outside the suggested range. Estimates were extrapolated with unknown errors

Flow-Duration Statistics Flow Report[100 Percent (0.181 square miles) LowFlow Ann Region01 2008 5126]

Statistic	Value	Unit
5 Percent Duration	2	ft ³ /s
10 Percent Duration	1.29	ft ³ /s
25 Percent Duration	0.543	ft ³ /s
50 Percent Duration	0.163	ft ³ /s
95 Percent Duration	0.0098	ft ³ /s

Flow-Duration Statistics Citations

Risley, John, Stonewall, Adam, and Haluska, Tana, 2008, Estimating flow-duration and low-flow frequency statistics for unregulated streams in Oregon: U.S. Geological Survey Scientific Investigations Report 2008-5126, 22 p. (<http://pubs.usgs.gov/sir/2008/5126/>)

Monthly Flow Statistics Parameters[100 Percent (0.181 square miles) LowFlow Apr Region01 2008 5126]

Parameter Code	Parameter Name	Value	Units	Min Limit	Max Limit
DRNAREA	Drainage Area	0.18	square miles	0.367	673.359
PRECIP	Mean Annual Precipitation	48.6	inches	65.5923	151.2906

Monthly Flow Statistics Parameters[100 Percent (0.181 square miles) LowFlow Aug Region01 2008 5126]

Parameter Code	Parameter Name	Value	Units	Min Limit	Max Limit
DRNAREA	Drainage Area	0.18	square miles	0.367	673.359
JANMINTMP	Mean Min January Temperature	32.3	degrees F	30.678	34.661
PRECIP	Mean Annual Precipitation	48.6	inches	65.5923	151.2906

Monthly Flow Statistics Parameters[100 Percent (0.181 square miles) LowFlow Dec Region01 2008 5126]

Parameter Code	Parameter Name	Value	Units	Min Limit	Max Limit
DRNAREA	Drainage Area	0.18	square miles	0.367	673.359
PRECIP	Mean Annual Precipitation	48.6	inches	65.5923	151.2906

Monthly Flow Statistics Parameters[100 Percent (0.181 square miles) LowFlow Feb Region01 2008 5126]

Parameter Code	Parameter Name	Value	Units	Min Limit	Max Limit
DRNAREA	Drainage Area	0.18	square miles	0.367	673.359

PRECIP	Mean Annual Precipitation	48.6	inches	65.5923	151.2906
--------	---------------------------	------	--------	---------	----------

Monthly Flow Statistics Parameters[100 Percent (0.181 square miles) LowFlow Jan Region01 2008 5126]

Parameter Code	Parameter Name	Value	Units	Min Limit	Max Limit
DRNAREA	Drainage Area	0.18	square miles	0.367	673.359

PRECIP	Mean Annual Precipitation	48.6	inches	65.5923	151.2906
--------	---------------------------	------	--------	---------	----------

Monthly Flow Statistics Parameters[100 Percent (0.181 square miles) LowFlow Jul Region01 2008 5126]

Parameter Code	Parameter Name	Value	Units	Min Limit	Max Limit
DRNAREA	Drainage Area	0.18	square miles	0.367	673.359

JANMINTMP	Mean Min January Temperature	32.3	degrees F	30.678	34.661
-----------	------------------------------	------	-----------	--------	--------

PRECIP	Mean Annual Precipitation	48.6	inches	65.5923	151.2906
--------	---------------------------	------	--------	---------	----------

Monthly Flow Statistics Parameters[100 Percent (0.181 square miles) LowFlow Jun Region01 2008 5126]

Parameter Code	Parameter Name	Value	Units	Min Limit	Max Limit
DRNAREA	Drainage Area	0.18	square miles	0.367	673.359

PRECIP	Mean Annual Precipitation	48.6	inches	65.5923	151.2906
--------	---------------------------	------	--------	---------	----------

Monthly Flow Statistics Parameters[100 Percent (0.181 square miles) LowFlow Mar Region01 2008 5126]

Parameter Code	Parameter Name	Value	Units	Min Limit	Max Limit
DRNAREA	Drainage Area	0.18	square miles	0.367	673.359

PRECIP	Mean Annual Precipitation	48.6	inches	65.5923	151.2906
--------	---------------------------	------	--------	---------	----------

Monthly Flow Statistics Parameters[100 Percent (0.181 square miles) LowFlow May Region01 2008 5126]

Parameter Code	Parameter Name	Value	Units	Min Limit	Max Limit
DRNAREA	Drainage Area	0.18	square miles	1.953	673.359

PRECIP	Mean Annual Precipitation	48.6	inches	65.5923	151.2906
--------	---------------------------	------	--------	---------	----------

Monthly Flow Statistics Parameters[100 Percent (0.181 square miles) LowFlow Nov Region01 2008 5126]

Parameter Code	Parameter Name	Value	Units	Min Limit	Max Limit
DRNAREA	Drainage Area	0.18	square miles	0.367	673.359

ELEV	Mean Basin Elevation	326	feet	520.406	2101.874
------	----------------------	-----	------	---------	----------

PRECIP	Mean Annual Precipitation	48.6	inches	65.5923	151.2906
--------	---------------------------	------	--------	---------	----------

Monthly Flow Statistics Parameters[100 Percent (0.181 square miles) LowFlow Oct Region01 2008 5126]

Parameter Code	Parameter Name	Value	Units	Min Limit	Max Limit
DRNAREA	Drainage Area	0.18	square miles	0.367	219.691

ELEV	Mean Basin Elevation	326	feet	520.406	2101.874
------	----------------------	-----	------	---------	----------

PRECIP	Mean Annual Precipitation	48.6	inches	71.6651	143.4891
--------	---------------------------	------	--------	---------	----------

Monthly Flow Statistics Parameters[100 Percent (0.181 square miles) LowFlow Sep Region01 2008 5126]

Parameter Code	Parameter Name	Value	Units	Min Limit	Max Limit
DRNAREA	Drainage Area	0.18	square miles	0.367	590.347
PRECIP	Mean Annual Precipitation	48.6	inches	65.5923	151.2906

Monthly Flow Statistics Disclaimers[100 Percent (0.181 square miles) LowFlow Apr Region01 2008 5126]

One or more of the parameters is outside the suggested range. Estimates were extrapolated with unknown errors

Monthly Flow Statistics Flow Report[100 Percent (0.181 square miles) LowFlow Apr Region01 2008 5126]

Statistic	Value	Unit
Apr 7 Day 2 Year Low Flow	0.23	ft ³ /s
Apr 7 Day 10 Year Low Flow	0.129	ft ³ /s

Monthly Flow Statistics Disclaimers[100 Percent (0.181 square miles) LowFlow Aug Region01 2008 5126]

One or more of the parameters is outside the suggested range. Estimates were extrapolated with unknown errors

Monthly Flow Statistics Flow Report[100 Percent (0.181 square miles) LowFlow Aug Region01 2008 5126]

Statistic	Value	Unit
Aug 7 Day 2 Year Low Flow	0.00808	ft ³ /s
Aug 7 Day 10 Year Low Flow	0.00435	ft ³ /s

Monthly Flow Statistics Disclaimers[100 Percent (0.181 square miles) LowFlow Dec Region01 2008 5126]

One or more of the parameters is outside the suggested range. Estimates were extrapolated with unknown errors

Monthly Flow Statistics Flow Report[100 Percent (0.181 square miles) LowFlow Dec Region01 2008 5126]

Statistic	Value	Unit
Dec 7 Day 2 Year Low Flow	0.376	ft ³ /s

Statistic	Value	Unit
Dec 7 Day 10 Year Low Flow	0.104	ft ³ /s

Monthly Flow Statistics Disclaimers[100 Percent (0.181 square miles) LowFlow Feb Region01 2008 5126]

One or more of the parameters is outside the suggested range. Estimates were extrapolated with unknown errors

Monthly Flow Statistics Flow Report[100 Percent (0.181 square miles) LowFlow Feb Region01 2008 5126]

Statistic	Value	Unit
Feb 7 Day 2 Year Low Flow	0.452	ft ³ /s
Feb 7 Day 10 Year Low Flow	0.211	ft ³ /s

Monthly Flow Statistics Disclaimers[100 Percent (0.181 square miles) LowFlow Jan Region01 2008 5126]

One or more of the parameters is outside the suggested range. Estimates were extrapolated with unknown errors

Monthly Flow Statistics Flow Report[100 Percent (0.181 square miles) LowFlow Jan Region01 2008 5126]

Statistic	Value	Unit
Jan 7 Day 2 Year Low Flow	0.544	ft ³ /s
Jan 7 Day 10 Year Low Flow	0.252	ft ³ /s

Monthly Flow Statistics Disclaimers[100 Percent (0.181 square miles) LowFlow Jul Region01 2008 5126]

One or more of the parameters is outside the suggested range. Estimates were extrapolated with unknown errors

Monthly Flow Statistics Flow Report[100 Percent (0.181 square miles) LowFlow Jul Region01 2008 5126]

Statistic	Value	Unit
Jul 7 Day 2 Year Low Flow	0.0134	ft ³ /s
Jul 7 Day 10 Year Low Flow	0.00879	ft ³ /s

Monthly Flow Statistics Disclaimers[100 Percent (0.181 square miles) LowFlow Jun Region01 2008 5126]

One or more of the parameters is outside the suggested range. Estimates were extrapolated with unknown errors

Monthly Flow Statistics Flow Report[100 Percent (0.181 square miles) LowFlow Jun Region01 2008 5126]

Statistic	Value	Unit
Jun 7 Day 2 Year Low Flow	0.0664	ft ³ /s
Jun 7 Day 10 Year Low Flow	0.0452	ft ³ /s

Monthly Flow Statistics Disclaimers[100 Percent (0.181 square miles) LowFlow Mar Region01 2008 5126]

One or more of the parameters is outside the suggested range. Estimates were extrapolated with unknown errors

Monthly Flow Statistics Flow Report[100 Percent (0.181 square miles) LowFlow Mar Region01 2008 5126]

Statistic	Value	Unit
Mar 7 Day 2 Year Low Flow	0.394	ft ³ /s
Mar 7 Day 10 Year Low Flow	0.219	ft ³ /s

Monthly Flow Statistics Disclaimers[100 Percent (0.181 square miles) LowFlow May Region01 2008 5126]

One or more of the parameters is outside the suggested range. Estimates were extrapolated with unknown errors

Monthly Flow Statistics Flow Report[100 Percent (0.181 square miles) LowFlow May Region01 2008 5126]

Statistic	Value	Unit
May 7 Day 2 Year Low Flow	0.174	ft ³ /s
May 7 Day 10 Year Low Flow	0.128	ft ³ /s

Monthly Flow Statistics Disclaimers[100 Percent (0.181 square miles) LowFlow Nov Region01 2008 5126]

One or more of the parameters is outside the suggested range. Estimates were extrapolated with unknown errors

Monthly Flow Statistics Flow Report[100 Percent (0.181 square miles) LowFlow Nov Region01 2008 5126]

Statistic	Value	Unit
-----------	-------	------

Statistic	Value	Unit
Nov 7 Day 2 Year Low Flow	0.0976	ft ³ /s

Nov 7 Day 10 Year Low Flow	0.0399	ft ³ /s
----------------------------	--------	--------------------

Monthly Flow Statistics Disclaimers[100 Percent (0.181 square miles) LowFlow Oct Region01 2008 5126]

One or more of the parameters is outside the suggested range. Estimates were extrapolated with unknown errors

Monthly Flow Statistics Flow Report[100 Percent (0.181 square miles) LowFlow Oct Region01 2008 5126]

Statistic	Value	Unit
Oct 7 Day 2 Year Low Flow	0.00965	ft ³ /s

Oct 7 Day 10 Year Low Flow	0.00436	ft ³ /s
----------------------------	---------	--------------------

Monthly Flow Statistics Disclaimers[100 Percent (0.181 square miles) LowFlow Sep Region01 2008 5126]

One or more of the parameters is outside the suggested range. Estimates were extrapolated with unknown errors

Monthly Flow Statistics Flow Report[100 Percent (0.181 square miles) LowFlow Sep Region01 2008 5126]

Statistic	Value	Unit
Sep 7 Day 2 Year Low Flow	0.00928	ft ³ /s

Sep 7 Day 10 Year Low Flow	0.00391	ft ³ /s
----------------------------	---------	--------------------

Monthly Flow Statistics Flow Report[Area-Averaged]

Statistic	Value	Unit
Apr 7 Day 2 Year Low Flow	0.229	ft ³ /s

Apr 7 Day 10 Year Low Flow	0.129	ft ³ /s
----------------------------	-------	--------------------

Aug 7 Day 2 Year Low Flow	0.00806	ft ³ /s
---------------------------	---------	--------------------

Aug 7 Day 10 Year Low Flow	0.00434	ft ³ /s
----------------------------	---------	--------------------

Dec 7 Day 2 Year Low Flow	0.375	ft ³ /s
---------------------------	-------	--------------------

Dec 7 Day 10 Year Low Flow	0.104	ft ³ /s
----------------------------	-------	--------------------

Feb 7 Day 2 Year Low Flow	0.451	ft ³ /s
---------------------------	-------	--------------------

Statistic	Value	Unit
Feb 7 Day 10 Year Low Flow	0.211	ft ³ /s
Jan 7 Day 2 Year Low Flow	0.543	ft ³ /s
Jan 7 Day 10 Year Low Flow	0.251	ft ³ /s
Jul 7 Day 2 Year Low Flow	0.0134	ft ³ /s
Jul 7 Day 10 Year Low Flow	0.00877	ft ³ /s
Jun 7 Day 2 Year Low Flow	0.0662	ft ³ /s
Jun 7 Day 10 Year Low Flow	0.0451	ft ³ /s
Mar 7 Day 2 Year Low Flow	0.393	ft ³ /s
Mar 7 Day 10 Year Low Flow	0.218	ft ³ /s
May 7 Day 2 Year Low Flow	0.174	ft ³ /s
May 7 Day 10 Year Low Flow	0.128	ft ³ /s
Nov 7 Day 2 Year Low Flow	0.0974	ft ³ /s
Nov 7 Day 10 Year Low Flow	0.0398	ft ³ /s
Oct 7 Day 2 Year Low Flow	0.00963	ft ³ /s
Oct 7 Day 10 Year Low Flow	0.00435	ft ³ /s
Sep 7 Day 2 Year Low Flow	0.00926	ft ³ /s
Sep 7 Day 10 Year Low Flow	0.0039	ft ³ /s

Monthly Flow Statistics Citations

Risley, John, Stonewall, Adam, and Haluska, Tana, 2008, Estimating flow-duration and low-flow frequency statistics for unregulated streams in Oregon: U.S. Geological Survey Scientific Investigations Report 2008-5126, 22 p. (<http://pubs.usgs.gov/sir/2008/5126/>)

January Flow-Duration Statistics Parameters^S[100 Percent (0.181 square miles) LowFlow Jan Region01 2008 5126]

Parameter Code	Parameter Name	Value	Units	Min Limit	Max Limit
DRNAREA	Drainage Area	0.18	square miles	0.367	673.359

Parameter Code	Parameter Name	Value	Units	Min Limit	Max Limit
IMPERV	Percent Impervious	8.15	percent	0	2.961
PRECIP	Mean Annual Precipitation	48.6	inches	65.5923	151.2906

January Flow-Duration Statistics Disclaimers[100 Percent (0.181 square miles) LowFlow Jan Region01 2008 5126]

One or more of the parameters is outside the suggested range. Estimates were extrapolated with unknown errors

January Flow-Duration Statistics Flow Report[100 Percent (0.181 square miles) LowFlow Jan Region01 2008 5126]

Statistic	Value	Unit
January 5 Percent Duration	3.55	ft ³ /s
January 10 Percent Duration	2.55	ft ³ /s
January 25 Percent Duration	1.36	ft ³ /s
January 50 Percent Duration	0.958	ft ³ /s
January 95 Percent Duration	0.203	ft ³ /s

January Flow-Duration Statistics Citations

Risley, John, Stonewall, Adam, and Haluska, Tana, 2008, Estimating flow-duration and low-flow frequency statistics for unregulated streams in Oregon: U.S. Geological Survey Scientific Investigations Report 2008-5126, 22 p. (<http://pubs.usgs.gov/sir/2008/5126/>)

February Flow-Duration Statistics Parameters[100 Percent (0.181 square miles) LowFlow Feb Region01 2008 5126]

Parameter Code	Parameter Name	Value	Units	Min Limit	Max Limit
DRNAREA	Drainage Area	0.18	square miles	0.367	673.359
IMPERV	Percent Impervious	8.15	percent	0	2.961
PRECIP	Mean Annual Precipitation	48.6	inches	65.5923	151.2906

Parameter Code	Parameter Name	Value	Units	Min Limit	Max Limit
BSLOPD	Mean Basin Slope degrees	4.68	degrees	10.382	25.482

February Flow-Duration Statistics Disclaimers[100 Percent (0.181 square miles) LowFlow Feb Region01 2008 5126]

One or more of the parameters is outside the suggested range. Estimates were extrapolated with unknown errors

February Flow-Duration Statistics Flow Report[100 Percent (0.181 square miles) LowFlow Feb Region01 2008 5126]

Statistic	Value	Unit
February 5 Percent Duration	1.05	ft ³ /s
February 10 Percent Duration	0.973	ft ³ /s
February 25 Percent Duration	0.8	ft ³ /s
February 50 Percent Duration	0.758	ft ³ /s
February 95 Percent Duration	0.233	ft ³ /s

February Flow-Duration Statistics Citations

Risley, John, Stonewall, Adam, and Haluska, Tana, 2008, Estimating flow-duration and low-flow frequency statistics for unregulated streams in Oregon: U.S. Geological Survey Scientific Investigations Report 2008-5126, 22 p. (<http://pubs.usgs.gov/sir/2008/5126/>)

March Flow-Duration Statistics Parameters[100 Percent (0.181 square miles) LowFlow Mar Region01 2008 5126]

Parameter Code	Parameter Name	Value	Units	Min Limit	Max Limit
DRNAREA	Drainage Area	0.18	square miles	0.367	673.359
IMPERV	Percent Impervious	8.15	percent	0	2.961
PRECIP	Mean Annual Precipitation	48.6	inches	65.5923	151.2906

Parameter Code	Parameter Name	Value	Units	Min Limit	Max Limit
BSLOPD	Mean Basin Slope degrees	4.68	degrees	10.382	25.482

March Flow-Duration Statistics Disclaimers[100 Percent (0.181 square miles) LowFlow Mar Region01 2008 5126]

One or more of the parameters is outside the suggested range. Estimates were extrapolated with unknown errors

March Flow-Duration Statistics Flow Report[100 Percent (0.181 square miles) LowFlow Mar Region01 2008 5126]

Statistic	Value	Unit
March 5 Percent Duration	0.947	ft ³ /s
March 10 Percent Duration	0.826	ft ³ /s
March 25 Percent Duration	0.621	ft ³ /s
March 50 Percent Duration	0.412	ft ³ /s
March 95 Percent Duration	0.21	ft ³ /s

March Flow-Duration Statistics Citations

Risley, John, Stonewall, Adam, and Haluska, Tana, 2008, Estimating flow-duration and low-flow frequency statistics for unregulated streams in Oregon: U.S. Geological Survey Scientific Investigations Report 2008-5126, 22 p. (<http://pubs.usgs.gov/sir/2008/5126/>)

April Flow-Duration Statistics Parameters[100 Percent (0.181 square miles) LowFlow Apr Region01 2008 5126]

Parameter Code	Parameter Name	Value	Units	Min Limit	Max Limit
DRNAREA	Drainage Area	0.18	square miles	0.367	673.359
PRECIP	Mean Annual Precipitation	48.6	inches	65.5923	151.2906
BSLOPD	Mean Basin Slope degrees	4.68	degrees	10.382	25.482

April Flow-Duration Statistics Disclaimers[100 Percent (0.181 square miles) LowFlow Apr Region01 2008 5126]

One or more of the parameters is outside the suggested range. Estimates were extrapolated with unknown errors

April Flow-Duration Statistics Flow Report[100 Percent (0.181 square miles) LowFlow Apr Region01 2008 5126]

Statistic	Value	Unit
April 5 Percent Duration	0.661	ft ³ /s
April 10 Percent Duration	0.523	ft ³ /s
April 25 Percent Duration	0.321	ft ³ /s
April 50 Percent Duration	0.208	ft ³ /s
April 95 Percent Duration	0.152	ft ³ /s

April Flow-Duration Statistics Citations

Risley, John, Stonewall, Adam, and Haluska, Tana, 2008, Estimating flow-duration and low-flow frequency statistics for unregulated streams in Oregon: U.S. Geological Survey Scientific Investigations Report 2008-5126, 22 p. (<http://pubs.usgs.gov/sir/2008/5126/>)

May Flow-Duration Statistics Parameters[100 Percent (0.181 square miles) LowFlow May Region01 2008 5126]

Parameter Code	Parameter Name	Value	Units	Min Limit	Max Limit
DRNAREA	Drainage Area	0.18	square miles	1.953	673.35
PRECIP	Mean Annual Precipitation	48.6	inches	65.5923	151.29
BSLOPD	Mean Basin Slope degrees	4.68	degrees	10.382	25.482
WATCAPORR	Available_Water_Capacity_OR_Risley	0.11	inch per inch	0.12	0.23

May Flow-Duration Statistics Disclaimers[100 Percent (0.181 square miles) LowFlow May Region01 2008 5126]

One or more of the parameters is outside the suggested range. Estimates were extrapolated with unknown errors

May Flow-Duration Statistics Flow Report[100 Percent (0.181 square miles) LowFlow May Region01 2008 5126]

Statistic	Value	Unit
May 5 Percent Duration	0.193	ft ³ /s
May 10 Percent Duration	0.163	ft ³ /s
May 25 Percent Duration	0.123	ft ³ /s
May 50 Percent Duration	0.0732	ft ³ /s
May 95 Percent Duration	0.0515	ft ³ /s

May Flow-Duration Statistics Citations

Risley, John, Stonewall, Adam, and Haluska, Tana, 2008, Estimating flow-duration and low-flow frequency statistics for unregulated streams in Oregon: U.S. Geological Survey Scientific Investigations Report 2008-5126, 22 p. (<http://pubs.usgs.gov/sir/2008/5126/>)

June Flow-Duration Statistics Parameters[100 Percent (0.181 square miles) LowFlow Jun Region01 2008 5126]

Parameter Code	Parameter Name	Value	Units	Min Limit	Max Limit
DRNAREA	Drainage Area	0.18	square miles	0.367	673.35
PRECIP	Mean Annual Precipitation	48.6	inches	65.5923	151.29
BSLOPD	Mean Basin Slope degrees	4.68	degrees	10.382	25.482
WATCAPORR	Available_Water_Capacity_OR_Risley	0.11	inch per inch	0.12	0.23

June Flow-Duration Statistics Disclaimers[100 Percent (0.181 square miles) LowFlow Jun Region01 2008 5126]

One or more of the parameters is outside the suggested range. Estimates were extrapolated with unknown errors

June Flow-Duration Statistics Flow Report[100 Percent (0.181 square miles) LowFlow Jun Region01 2008 5126]

Statistic	Value	Unit
-----------	-------	------

Statistic	Value	Unit
June 5 Percent Duration	0.122	ft ³ /s
June 10 Percent Duration	0.0789	ft ³ /s
June 25 Percent Duration	0.0422	ft ³ /s
June 50 Percent Duration	0.0335	ft ³ /s
June 95 Percent Duration	0.0437	ft ³ /s

June Flow-Duration Statistics Citations

Risley, John, Stonewall, Adam, and Haluska, Tana, 2008, Estimating flow-duration and low-flow frequency statistics for unregulated streams in Oregon: U.S. Geological Survey Scientific Investigations Report 2008-5126, 22 p. (<http://pubs.usgs.gov/sir/2008/5126/>)

July Flow-Duration Statistics Parameters[100 Percent (0.181 square miles) LowFlow Jul Region01 2008 5126]

Parameter Code	Parameter Name	Value	Units	Min Limit	Max Limit
DRNAREA	Drainage Area	0.18	square miles	0.367	673.35
PRECIP	Mean Annual Precipitation	48.6	inches	65.5923	151.29
WATCAPORR	Available_Water_Capacity_OR_Risley	0.11	inch per inch	0.12	0.23
BSLOPD	Mean Basin Slope degrees	4.68	degrees	10.382	25.482

July Flow-Duration Statistics Disclaimers[100 Percent (0.181 square miles) LowFlow Jul Region01 2008 5126]

One or more of the parameters is outside the suggested range. Estimates were extrapolated with unknown errors

July Flow-Duration Statistics Flow Report[100 Percent (0.181 square miles) LowFlow Jul Region01 2008 5126]

Statistic	Value	Unit
July 5 Percent Duration	0.0882	ft ³ /s
July 10 Percent Duration	0.0713	ft ³ /s

Statistic	Value	Unit
July 25 Percent Duration	0.0502	ft ³ /s
July 50 Percent Duration	0.0148	ft ³ /s
July 95 Percent Duration	0.00532	ft ³ /s

July Flow-Duration Statistics Citations

Risley, John, Stonewall, Adam, and Haluska, Tana, 2008, Estimating flow-duration and low-flow frequency statistics for unregulated streams in Oregon: U.S. Geological Survey Scientific Investigations Report 2008-5126, 22 p. (<http://pubs.usgs.gov/sir/2008/5126/>)

August Flow-Duration Statistics Parameters_[100 Percent (0.181 square miles) LowFlow Aug Region01 2008 5126]

Parameter Code	Parameter Name	Value	Units	Min Limit	Max Limit
DRNAREA	Drainage Area	0.18	square miles	0.367	673.359
MINBELEV	Minimum Basin Elevation	198	feet	10.5648	1381.5307
PRECIP	Mean Annual Precipitation	48.6	inches	65.5923	151.2906

August Flow-Duration Statistics Disclaimers_[100 Percent (0.181 square miles) LowFlow Aug Region01 2008 5126]

One or more of the parameters is outside the suggested range. Estimates were extrapolated with unknown errors

August Flow-Duration Statistics Flow Report_[100 Percent (0.181 square miles) LowFlow Aug Region01 2008 5126]

Statistic	Value	Unit
August 5 Percent Duration	0.0581	ft ³ /s
August 10 Percent Duration	0.0333	ft ³ /s
August 25 Percent Duration	0.0266	ft ³ /s
August 50 Percent Duration	0.0204	ft ³ /s
August 95 Percent Duration	0.00638	ft ³ /s

August Flow-Duration Statistics Citations

Risley, John, Stonewall, Adam, and Haluska, Tana,2008, Estimating flow-duration and low-flow frequency statistics for unregulated streams in Oregon: U.S. Geological Survey Scientific Investigations Report 2008-5126, 22 p. (<http://pubs.usgs.gov/sir/2008/5126/>)

September Flow-Duration Statistics Parameters[100 Percent (0.181 square miles) LowFlow Sep Region01 2008 5126]

Parameter Code	Parameter Name	Value	Units	Min Limit	Max Limit
DRNAREA	Drainage Area	0.18	square miles	0.367	590.347
MINBELEV	Minimum Basin Elevation	198	feet	10.5648	1381.5307
PRECIP	Mean Annual Precipitation	48.6	inches	65.5923	151.2906

September Flow-Duration Statistics Disclaimers[100 Percent (0.181 square miles) LowFlow Sep Region01 2008 5126]

One or more of the parameters is outside the suggested range. Estimates were extrapolated with unknown errors

September Flow-Duration Statistics Flow Report[100 Percent (0.181 square miles) LowFlow Sep Region01 2008 5126]

Statistic	Value	Unit
September 5 Percent Duration	0.0607	ft ³ /s
September 10 Percent Duration	0.0431	ft ³ /s
September 25 Percent Duration	0.027	ft ³ /s
September 50 Percent Duration	0.0126	ft ³ /s
September 95 Percent Duration	0.0035	ft ³ /s

September Flow-Duration Statistics Citations

Risley, John, Stonewall, Adam, and Haluska, Tana,2008, Estimating flow-duration and low-flow frequency statistics for unregulated streams in Oregon: U.S.

Geological Survey Scientific Investigations Report 2008-5126, 22 p.
 (<http://pubs.usgs.gov/sir/2008/5126/>)

October Flow-Duration Statistics Parameters[100 Percent (0.181 square miles) LowFlow Oct Region01 2008 5126]

Parameter Code	Parameter Name	Value	Units	Min Limit	Max Limit
DRNAREA	Drainage Area	0.18	square miles	0.367	219.691
ELEV	Mean Basin Elevation	326	feet	520.406	2101.874
PRECIP	Mean Annual Precipitation	48.6	inches	71.6651	143.4891

October Flow-Duration Statistics Disclaimers[100 Percent (0.181 square miles) LowFlow Oct Region01 2008 5126]

One or more of the parameters is outside the suggested range. Estimates were extrapolated with unknown errors

October Flow-Duration Statistics Flow Report[100 Percent (0.181 square miles) LowFlow Oct Region01 2008 5126]

Statistic	Value	Unit
October 5 Percent Duration	0.289	ft ³ /s
October 10 Percent Duration	0.184	ft ³ /s
October 25 Percent Duration	0.0696	ft ³ /s
October 50 Percent Duration	0.0203	ft ³ /s
October 95 Percent Duration	0.00605	ft ³ /s

October Flow-Duration Statistics Citations

Risley, John, Stonewall, Adam, and Haluska, Tana, 2008, Estimating flow-duration and low-flow frequency statistics for unregulated streams in Oregon: U.S. Geological Survey Scientific Investigations Report 2008-5126, 22 p.
 (<http://pubs.usgs.gov/sir/2008/5126/>)

November Flow-Duration Statistics Parameters[100 Percent (0.181 square miles) LowFlow Nov Region01 2008 5126]

Parameter Code	Parameter Name	Value	Units	Min Limit	Max Limit
DRNAREA	Drainage Area	0.18	square miles	0.367	673.359
PRECIP	Mean Annual Precipitation	48.6	inches	65.5923	151.2906
BSLOPD	Mean Basin Slope	4.68	degrees	10.382	25.482
MAXBSLOPD	Maximum Basin Slope	14.5	degrees in deg	34.073	68.78

November Flow-Duration Statistics Disclaimers[100 Percent (0.181 square miles) LowFlow Nov Region01 2008 5126]

One or more of the parameters is outside the suggested range. Estimates were extrapolated with unknown errors

November Flow-Duration Statistics Flow Report[100 Percent (0.181 square miles) LowFlow Nov Region01 2008 5126]

Statistic	Value	Unit
November 5 Percent Duration	1.07	ft ³ /s
November 10 Percent Duration	0.782	ft ³ /s
November 25 Percent Duration	0.366	ft ³ /s
November 50 Percent Duration	0.134	ft ³ /s
November 95 Percent Duration	0.446	ft ³ /s

November Flow-Duration Statistics Citations

Risley, John, Stonewall, Adam, and Haluska, Tana, 2008, Estimating flow-duration and low-flow frequency statistics for unregulated streams in Oregon: U.S. Geological Survey Scientific Investigations Report 2008-5126, 22 p. (<http://pubs.usgs.gov/sir/2008/5126/>)

December Flow-Duration Statistics Parameters[100 Percent (0.181 square miles) LowFlow Dec Region01 2008 5126]

Parameter Code	Parameter Name	Value	Units	Min Limit	Max Limit
----------------	----------------	-------	-------	-----------	-----------

Parameter Code	Parameter Name	Value	Units	Min Limit	Max Limit
DRNAREA	Drainage Area	0.18	square miles	0.367	673.359
PRECIP	Mean Annual Precipitation	48.6	inches	65.5923	151.2906
BSLOPD	Mean Basin Slope	4.68	degrees	10.382	25.482

December Flow-Duration Statistics Disclaimers[100 Percent (0.181 square miles) LowFlow Dec Region01 2008 5126]

One or more of the parameters is outside the suggested range. Estimates were extrapolated with unknown errors

December Flow-Duration Statistics Flow Report[100 Percent (0.181 square miles) LowFlow Dec Region01 2008 5126]

Statistic	Value	Unit
December 5 Percent Duration	1.4	ft ³ /s
December 10 Percent Duration	1.35	ft ³ /s
December 25 Percent Duration	1.45	ft ³ /s
December 50 Percent Duration	0.746	ft ³ /s
December 95 Percent Duration	0.1	ft ³ /s

December Flow-Duration Statistics Citations

Risley, John, Stonewall, Adam, and Haluska, Tana, 2008, Estimating flow-duration and low-flow frequency statistics for unregulated streams in Oregon: U.S. Geological Survey Scientific Investigations Report 2008-5126, 22 p. (<http://pubs.usgs.gov/sir/2008/5126/>)

USGS Data Disclaimer: Unless otherwise stated, all data, metadata and related materials are considered to satisfy the quality standards relative to the purpose for which the data were collected. Although these data and associated metadata have been reviewed for accuracy and completeness and approved for release by the U.S. Geological Survey (USGS), no warranty expressed or implied is made regarding the display or utility of the data for other purposes, nor on all computer systems, nor shall the act of distribution constitute any such warranty.

USGS Software Disclaimer: This software has been approved for release by the U.S. Geological Survey (USGS). Although the software has been subjected to rigorous review, the USGS reserves the right to update the software as needed pursuant to further analysis and review. No warranty, expressed or implied, is made by the USGS or the U.S. Government as to the functionality of the software and related material nor shall the fact of release constitute any such warranty. Furthermore, the software is released on condition that neither the USGS nor the U.S. Government shall be held liable for any damages resulting from its authorized or unauthorized use.

USGS Product Names Disclaimer: Any use of trade, firm, or product names is for descriptive purposes only and does not imply endorsement by the U.S. Government.

Application Version: 4.4.0



Tributary to Intermittent Stream B
Stream Function Assessment Method (SFAM)
Report



Report Generated: October 29, 2020 11:24 AM

Location Information

Latitude	45.8691 N	Longitude	-122.8196 W
Elevation	200 ft	Level III Ecoregion	Willamette Valley
HUC8	17080003 Lower Columbia-Clatskanie		
HUC10	1708000304 Beaver Creek-Frontal Columbia River		
HUC12	170800030401 Deer Island Slough-Frontal Columbia River		
Linear ft of stream in HUC8	216,535	Annual precipitation	44 in

Stream Type and Classifications

No results

Stream classifications and associated attributes are derived from a U.S. Environmental Protection Agency stream classification geospatial data layer developed for Oregon (2015). This layer provides a statewide stream/watershed classification system for streams and rivers of various sizes, based in part on a hydrologic landscape classification system.

Report Generated: October 29, 2020 11:24 AM

Rare Species Scores and Special Habitat Designations

Rare Species Type	Maximum score	Sum Score	Rating
Non-anadromous Fish Species	0	0	None
Amphibian & Reptile Species	0	0	None
Feeding Waterbirds	0	0	None
Songbirds, Raptors, and Mammals	0	0	None
Invertebrate Species	0	0	None
Plant Species	0	0	None

Scores have taken into account several factors for each rare species record contained in the official database of the Oregon Biodiversity Information Center (ORBIC): (a) the regional rarity of the species, (b) their proximity to the point of interest, and (c) the “certainty” that ORBIC assigns to each of those records.

Within 300 ft of a Special Protected Area?	No
Within a HUC12 that has designated Essential Salmonid Habitat?	Yes
Within 2 miles of an Important Bird Area?	No

Water Quality Impairments

Query returned no records.

Water quality information is derived from Oregon’s 2012 Integrated Report, including the list of water quality limited waters needing Total Maximum Daily Loads (303d List). Each record in the report is assigned an assessment category based on an evaluation of water quality information. Categories included in the SFAM Report are:

Category 5: Water is water quality limited and a TMDL is needed; Section 303(d) list.

Category 4: Water is impaired or threatened but a TMDL is not needed because: (A) the TMDL is approved, (B) other pollution requirements are in place, or (C) the impairment (such as flow or lack of flow)

Report Generated: October 29, 2020 11:24 AM

is not caused by a pollutant.

Category 3B: Water quality is of potential concern; some data indicate non-attainment of a criterion, but data are insufficient to assign another category.

Dominant soil type(s)			
Soil Type	Erosion Hazard Rating	Hydric Rating	Percent Area
Rock outcrop-Xerumbrepts complex, undulating	Not rated	No	100.00%

This report contains both centroid-based and polygon-based data. The Location Information section of the report contains centroid-based data (determined by the center point of the polygon), while the remaining sections are polygon-based (determined from the entire polygon).

Tributary to Intermittent Stream B

StreamStats Report

Region ID:

Workspace ID:

Clicked Point (Latitude, Longitude):

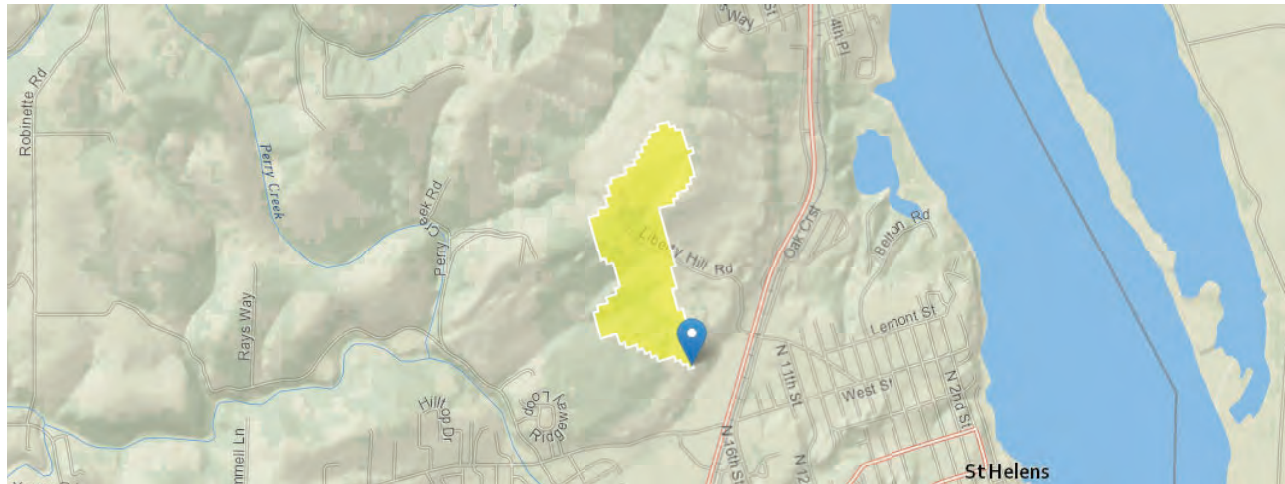
Time:

OR

OR20201029175327674000

45.86908, -122.81967

2020-10-29 10:53:46 -0700



Basin Characteristics

Parameter Code	Parameter Description	Value	Unit
DRNAREA	Area that drains to a point on a stream	0.18	square miles
I24H2Y	Maximum 24-hour precipitation that occurs on average once in 2 years - Equivalent to precipitation intensity index	1.77	inches
SOILPERM	Average Soil Permeability	2.2	inches per hour
JANMAXT2K	Mean Maximum January Temperature from 2K resolution PRISM 1961-1990 data	45.1	degrees F
WATCAPORC	Available water capacity from STATSGO data using methods from SIR 2005-5116	0.11	inches
ORREG2	Oregon Region Number	10001	dimensionless
BSLOPD	Mean basin slope measured in degrees	4.68	degrees
JANMINT2K	Mean Minimum January Temperature from 2K resolution PRISM PRISM 1961-1990 data	32.3	degrees F
ELEV	Mean Basin Elevation	326	feet
PRECIP	Mean Annual Precipitation	48.6	inches
WATCAPORR	Available water capacity from STATSGO data using methods from SIR 2008-5126	0.11	inch per inch
JANMINTMP	Mean Minimum January Temperature	32.3	degrees F
IMPERV	Percentage of impervious area	8.15	percent
MINBELEV	Minimum basin elevation	198	feet
MAXBSLOPD	Maximum basin slope, in degrees, using ArcInfo Grid with NHDPlus 30-m resolution elevation data.	14.5	degrees
DRNDENSITY	Basin drainage density defined as total stream length divided by drainage area.	0	dimensionless
ELEVMAX	Maximum basin elevation	447	feet
FOREST	Percentage of area covered by forest	75	percent
ASPECT	basin average of topographic slope compass directions from elevation grid	160	degrees
JANMAXTMP	Mean Maximum January Temperature	44.7	degrees F
JULAVPRE2K	Mean July Average Precipitation	0.64	inches
LC11CRPHAY	Percentage of cultivated crops and hay, classes 81 and 82, from NLCD 2011	33	percent
LC11BARE	Percentage of barren from NLCD 2011 class 31	0	percent
LC11DEVHI	Percentage of area developed, high intensity, NLCD 2011 class 24	0	percent

Parameter Code	Parameter Description	Value	Unit
LC11DVLO	Percentage of developed area, low intensity, from NLCD 2011 class 22	0	percent
LC11DVMD	Percentage of area developed, medium intensity, NLCD 2011 class 23	0	percent
LC11DVOPN	Percentage of developed open area from NLCD 2011 class 21	5	percent
LC11FORSHB	Percentage of forests and shrub lands, classes 41 to 52, from NLCD 2011	62	percent
LC11HERB	Percentage of herbaceous from NLCD 2011 classes 71-74	0	percent
LC11IMP	Average percentage of impervious area determined from NLCD 2011 impervious dataset	0.5	percent
LC11WATER	Percent of open water, class 11, from NLCD 2011	0	percent
LC11WETLND	Percentage of wetlands, classes 90 and 95, from NLCD 2011	0	percent
MAJ_ROADS	Length of non-state major roads in basin	0	miles
MAXTEMP	Mean annual maximum air temperature over basin area from PRISM 1971-2000 800-m grid	61.6	degrees F
MINBSLOPD	Minimum basin slope, in degrees, using ArcInfo Grid with NHDPlus 30-m resolution elevation data.	0.0272	degrees
MINTEMP	Mean annual minimum air temperature over basin surface area as defined in SIR 2008-5126	41.6	degrees F
MIN_ROADS	Length of non-state minor roads in basin	0.32	miles
OR_HIPERMA	Percent basin surface area containing high permeability aquifer units as defined in SIR 2008-5126	0	percent
OR_HIPERMG	Percent basin surface area containing high permeability geologic units as defined in SIR 2008-5126	0	percent
STRMTOT	total length of all mapped streams (1:24,000-scale) in the basin	0	miles
STATSGODEP	Area-weighted average soil depth from NRCS STATSGO database	45	inches
STATE_HWY	Length of state highways in basin	0	miles
RELIEF	Maximum - minimum elevation	249	feet

Peak-Flow Statistics Parameters^[Reg 2B Western Interior LT 3000 ft Cooper]

Parameter Code	Parameter Name	Value	Units	Min Limit	Max Limit
DRNAREA	Drainage Area	0.18	square miles	0.37	7270
BSLOPD	Mean Basin Slope degrees	4.68	degrees	5.62	28.3
I24H2Y	24 Hour 2 Year Precipitation	1.77	inches	1.53	4.48
ELEV	Mean Basin Elevation	326	feet		
ORREG2	Oregon Region Number	10001	dimensionless		

Peak-Flow Statistics Disclaimers^[Reg 2B Western Interior LT 3000 ft Cooper]

One or more of the parameters is outside the suggested range. Estimates were extrapolated with unknown errors

Peak-Flow Statistics Flow Report^[Reg 2B Western Interior LT 3000 ft Cooper]

Statistic	Value	Unit
2 Year Peak Flood	6.53	ft ³ /s
5 Year Peak Flood	9.75	ft ³ /s
10 Year Peak Flood	12	ft ³ /s
25 Year Peak Flood	14.8	ft ³ /s
50 Year Peak Flood	17	ft ³ /s
100 Year Peak Flood	19.1	ft ³ /s
500 Year Peak Flood	24.1	ft ³ /s

Peak-Flow Statistics Citations

Cooper, R.M., 2005, Estimation of Peak Discharges for Rural, Unregulated Streams in Western Oregon: U.S. Geological Survey Scientific Investigations Report 2005-5116, 76 p. (<http://pubs.usgs.gov/sir/2005/5116/pdf/sir2005-5116.pdf>)

Low-Flow Statistics Parameters^[100 Percent (0.181 square miles) LowFlow Ann Region01 2008 5126]

Parameter Code	Parameter Name	Value	Units	Min Limit	Max Limit
DRNAREA	Drainage Area	0.18	square miles	0.367	590.347
PRECIP	Mean Annual Precipitation	48.6	inches	65.5923	122.9843
WATCAPORR	Available_Water_Capacity_OR_Risley	0.11	inch per inch	0.12	0.23

Low-Flow Statistics Disclaimers[100 Percent (0.181 square miles) LowFlow Ann Region01 2008 5126]

One or more of the parameters is outside the suggested range. Estimates were extrapolated with unknown errors

Low-Flow Statistics Flow Report[100 Percent (0.181 square miles) LowFlow Ann Region01 2008 5126]

Statistic	Value	Unit
7 Day 2 Year Low Flow	0.00904	ft ³ /s
7 Day 10 Year Low Flow	0.00449	ft ³ /s

Low-Flow Statistics Citations

Risley, John, Stonewall, Adam, and Haluska, Tana, 2008, Estimating flow-duration and low-flow frequency statistics for unregulated streams in Oregon: U.S. Geological Survey Scientific Investigations Report 2008-5126, 22 p. (<http://pubs.usgs.gov/sir/2008/5126/>)

Flow-Duration Statistics Parameters[100 Percent (0.181 square miles) LowFlow Ann Region01 2008 5126]

Parameter Code	Parameter Name	Value	Units	Min Limit	Max Limit
DRNAREA	Drainage Area	0.18	square miles	0.367	590.347
PRECIP	Mean Annual Precipitation	48.6	inches	65.5923	122.9843
WATCAPORR	Available_Water_Capacity_OR_Risley	0.11	inch per inch	0.12	0.23

Flow-Duration Statistics Disclaimers[100 Percent (0.181 square miles) LowFlow Ann Region01 2008 5126]

One or more of the parameters is outside the suggested range. Estimates were extrapolated with unknown errors

Flow-Duration Statistics Flow Report[100 Percent (0.181 square miles) LowFlow Ann Region01 2008 5126]

Statistic	Value	Unit
5 Percent Duration	2	ft ³ /s
10 Percent Duration	1.29	ft ³ /s
25 Percent Duration	0.543	ft ³ /s
50 Percent Duration	0.163	ft ³ /s
95 Percent Duration	0.0098	ft ³ /s

Flow-Duration Statistics Citations

Risley, John, Stonewall, Adam, and Haluska, Tana, 2008, Estimating flow-duration and low-flow frequency statistics for unregulated streams in Oregon: U.S. Geological Survey Scientific Investigations Report 2008-5126, 22 p. (<http://pubs.usgs.gov/sir/2008/5126/>)

Monthly Flow Statistics Parameters[100 Percent (0.181 square miles) LowFlow Apr Region01 2008 5126]

Parameter Code	Parameter Name	Value	Units	Min Limit	Max Limit
DRNAREA	Drainage Area	0.18	square miles	0.367	673.359
PRECIP	Mean Annual Precipitation	48.6	inches	65.5923	151.2906

Monthly Flow Statistics Parameters[100 Percent (0.181 square miles) LowFlow Aug Region01 2008 5126]

Parameter Code	Parameter Name	Value	Units	Min Limit	Max Limit
DRNAREA	Drainage Area	0.18	square miles	0.367	673.359
JANMINTMP	Mean Min January Temperature	32.3	degrees F	30.678	34.661
PRECIP	Mean Annual Precipitation	48.6	inches	65.5923	151.2906

Monthly Flow Statistics Parameters[100 Percent (0.181 square miles) LowFlow Dec Region01 2008 5126]

Parameter Code	Parameter Name	Value	Units	Min Limit	Max Limit
DRNAREA	Drainage Area	0.18	square miles	0.367	673.359
PRECIP	Mean Annual Precipitation	48.6	inches	65.5923	151.2906

Monthly Flow Statistics Parameters[100 Percent (0.181 square miles) LowFlow Feb Region01 2008 5126]

Parameter Code	Parameter Name	Value	Units	Min Limit	Max Limit
DRNAREA	Drainage Area	0.18	square miles	0.367	673.359
PRECIP	Mean Annual Precipitation	48.6	inches	65.5923	151.2906

Monthly Flow Statistics Parameters[100 Percent (0.181 square miles) LowFlow Jan Region01 2008 5126]

Parameter Code	Parameter Name	Value	Units	Min Limit	Max Limit
DRNAREA	Drainage Area	0.18	square miles	0.367	673.359
PRECIP	Mean Annual Precipitation	48.6	inches	65.5923	151.2906

Monthly Flow Statistics Parameters[100 Percent (0.181 square miles) LowFlow Jul Region01 2008 5126]

Parameter Code	Parameter Name	Value	Units	Min Limit	Max Limit
DRNAREA	Drainage Area	0.18	square miles	0.367	673.359
JANMINTMP	Mean Min January Temperature	32.3	degrees F	30.678	34.661
PRECIP	Mean Annual Precipitation	48.6	inches	65.5923	151.2906

Monthly Flow Statistics Parameters[100 Percent (0.181 square miles) LowFlow Jun Region01 2008 5126]

Parameter Code	Parameter Name	Value	Units	Min Limit	Max Limit
DRNAREA	Drainage Area	0.18	square miles	0.367	673.359
PRECIP	Mean Annual Precipitation	48.6	inches	65.5923	151.2906

Monthly Flow Statistics Parameters[100 Percent (0.181 square miles) LowFlow Mar Region01 2008 5126]

Parameter Code	Parameter Name	Value	Units	Min Limit	Max Limit
DRNAREA	Drainage Area	0.18	square miles	0.367	673.359
PRECIP	Mean Annual Precipitation	48.6	inches	65.5923	151.2906

Monthly Flow Statistics Parameters[100 Percent (0.181 square miles) LowFlow May Region01 2008 5126]

Parameter Code	Parameter Name	Value	Units	Min Limit	Max Limit
DRNAREA	Drainage Area	0.18	square miles	1.953	673.359
PRECIP	Mean Annual Precipitation	48.6	inches	65.5923	151.2906

Monthly Flow Statistics Parameters[100 Percent (0.181 square miles) LowFlow Nov Region01 2008 5126]

Parameter Code	Parameter Name	Value	Units	Min Limit	Max Limit
DRNAREA	Drainage Area	0.18	square miles	0.367	673.359
ELEV	Mean Basin Elevation	326	feet	520.406	2101.874
PRECIP	Mean Annual Precipitation	48.6	inches	65.5923	151.2906

Monthly Flow Statistics Parameters[100 Percent (0.181 square miles) LowFlow Oct Region01 2008 5126]

Parameter Code	Parameter Name	Value	Units	Min Limit	Max Limit
DRNAREA	Drainage Area	0.18	square miles	0.367	219.691
ELEV	Mean Basin Elevation	326	feet	520.406	2101.874
PRECIP	Mean Annual Precipitation	48.6	inches	71.6651	143.4891

Monthly Flow Statistics Parameters[100 Percent (0.181 square miles) LowFlow Sep Region01 2008 5126]

Parameter Code	Parameter Name	Value	Units	Min Limit	Max Limit
----------------	----------------	-------	-------	-----------	-----------

Parameter Code	Parameter Name	Value	Units	Min Limit	Max Limit
DRNAREA	Drainage Area	0.18	square miles	0.367	590.347
PRECIP	Mean Annual Precipitation	48.6	inches	65.5923	151.2906

Monthly Flow Statistics Disclaimers(100 Percent (0.181 square miles) LowFlow Apr Region01 2008 5126)

One or more of the parameters is outside the suggested range. Estimates were extrapolated with unknown errors

Monthly Flow Statistics Flow Report(100 Percent (0.181 square miles) LowFlow Apr Region01 2008 5126)

Statistic	Value	Unit
Apr 7 Day 2 Year Low Flow	0.23	ft ³ /s
Apr 7 Day 10 Year Low Flow	0.129	ft ³ /s

Monthly Flow Statistics Disclaimers(100 Percent (0.181 square miles) LowFlow Aug Region01 2008 5126)

One or more of the parameters is outside the suggested range. Estimates were extrapolated with unknown errors

Monthly Flow Statistics Flow Report(100 Percent (0.181 square miles) LowFlow Aug Region01 2008 5126)

Statistic	Value	Unit
Aug 7 Day 2 Year Low Flow	0.00808	ft ³ /s
Aug 7 Day 10 Year Low Flow	0.00435	ft ³ /s

Monthly Flow Statistics Disclaimers(100 Percent (0.181 square miles) LowFlow Dec Region01 2008 5126)

One or more of the parameters is outside the suggested range. Estimates were extrapolated with unknown errors

Monthly Flow Statistics Flow Report(100 Percent (0.181 square miles) LowFlow Dec Region01 2008 5126)

Statistic	Value	Unit
Dec 7 Day 2 Year Low Flow	0.376	ft ³ /s
Dec 7 Day 10 Year Low Flow	0.104	ft ³ /s

Monthly Flow Statistics Disclaimers(100 Percent (0.181 square miles) LowFlow Feb Region01 2008 5126)

One or more of the parameters is outside the suggested range. Estimates were extrapolated with unknown errors

Monthly Flow Statistics Flow Report(100 Percent (0.181 square miles) LowFlow Feb Region01 2008 5126)

Statistic	Value	Unit
Feb 7 Day 2 Year Low Flow	0.452	ft ³ /s
Feb 7 Day 10 Year Low Flow	0.211	ft ³ /s

Monthly Flow Statistics Disclaimers(100 Percent (0.181 square miles) LowFlow Jan Region01 2008 5126)

One or more of the parameters is outside the suggested range. Estimates were extrapolated with unknown errors

Monthly Flow Statistics Flow Report(100 Percent (0.181 square miles) LowFlow Jan Region01 2008 5126)

Statistic	Value	Unit
Jan 7 Day 2 Year Low Flow	0.544	ft ³ /s
Jan 7 Day 10 Year Low Flow	0.252	ft ³ /s

Monthly Flow Statistics Disclaimers(100 Percent (0.181 square miles) LowFlow Jul Region01 2008 5126)

One or more of the parameters is outside the suggested range. Estimates were extrapolated with unknown errors

Monthly Flow Statistics Flow Report(100 Percent (0.181 square miles) LowFlow Jul Region01 2008 5126)

Statistic	Value	Unit
Jul 7 Day 2 Year Low Flow	0.0134	ft ³ /s

Statistic	Value	Unit
Jul 7 Day 10 Year Low Flow	0.00879	ft ³ /s
Monthly Flow Statistics Disclaimers(100 Percent (0.181 square miles) LowFlow Jun Region01 2008 5126)		
One or more of the parameters is outside the suggested range. Estimates were extrapolated with unknown errors		
Monthly Flow Statistics Flow Report(100 Percent (0.181 square miles) LowFlow Jun Region01 2008 5126)		
Statistic	Value	Unit
Jun 7 Day 2 Year Low Flow	0.0664	ft ³ /s
Jun 7 Day 10 Year Low Flow	0.0452	ft ³ /s
Monthly Flow Statistics Disclaimers(100 Percent (0.181 square miles) LowFlow Mar Region01 2008 5126)		
One or more of the parameters is outside the suggested range. Estimates were extrapolated with unknown errors		
Monthly Flow Statistics Flow Report(100 Percent (0.181 square miles) LowFlow Mar Region01 2008 5126)		
Statistic	Value	Unit
Mar 7 Day 2 Year Low Flow	0.394	ft ³ /s
Mar 7 Day 10 Year Low Flow	0.219	ft ³ /s
Monthly Flow Statistics Disclaimers(100 Percent (0.181 square miles) LowFlow May Region01 2008 5126)		
One or more of the parameters is outside the suggested range. Estimates were extrapolated with unknown errors		
Monthly Flow Statistics Flow Report(100 Percent (0.181 square miles) LowFlow May Region01 2008 5126)		
Statistic	Value	Unit
May 7 Day 2 Year Low Flow	0.174	ft ³ /s
May 7 Day 10 Year Low Flow	0.128	ft ³ /s
Monthly Flow Statistics Disclaimers(100 Percent (0.181 square miles) LowFlow Nov Region01 2008 5126)		
One or more of the parameters is outside the suggested range. Estimates were extrapolated with unknown errors		
Monthly Flow Statistics Flow Report(100 Percent (0.181 square miles) LowFlow Nov Region01 2008 5126)		
Statistic	Value	Unit
Nov 7 Day 2 Year Low Flow	0.0976	ft ³ /s
Nov 7 Day 10 Year Low Flow	0.0399	ft ³ /s
Monthly Flow Statistics Disclaimers(100 Percent (0.181 square miles) LowFlow Oct Region01 2008 5126)		
One or more of the parameters is outside the suggested range. Estimates were extrapolated with unknown errors		
Monthly Flow Statistics Flow Report(100 Percent (0.181 square miles) LowFlow Oct Region01 2008 5126)		
Statistic	Value	Unit
Oct 7 Day 2 Year Low Flow	0.00965	ft ³ /s
Oct 7 Day 10 Year Low Flow	0.00436	ft ³ /s
Monthly Flow Statistics Disclaimers(100 Percent (0.181 square miles) LowFlow Sep Region01 2008 5126)		
One or more of the parameters is outside the suggested range. Estimates were extrapolated with unknown errors		
Monthly Flow Statistics Flow Report(100 Percent (0.181 square miles) LowFlow Sep Region01 2008 5126)		
Statistic	Value	Unit
Sep 7 Day 2 Year Low Flow	0.00928	ft ³ /s
Sep 7 Day 10 Year Low Flow	0.00391	ft ³ /s

Monthly Flow Statistics Flow Report^(Area-Averaged)

Statistic	Value	Unit
Apr 7 Day 2 Year Low Flow	0.229	ft ³ /s
Apr 7 Day 10 Year Low Flow	0.129	ft ³ /s
Aug 7 Day 2 Year Low Flow	0.00806	ft ³ /s
Aug 7 Day 10 Year Low Flow	0.00434	ft ³ /s
Dec 7 Day 2 Year Low Flow	0.375	ft ³ /s
Dec 7 Day 10 Year Low Flow	0.104	ft ³ /s
Feb 7 Day 2 Year Low Flow	0.451	ft ³ /s
Feb 7 Day 10 Year Low Flow	0.211	ft ³ /s
Jan 7 Day 2 Year Low Flow	0.543	ft ³ /s
Jan 7 Day 10 Year Low Flow	0.251	ft ³ /s
Jul 7 Day 2 Year Low Flow	0.0134	ft ³ /s
Jul 7 Day 10 Year Low Flow	0.00877	ft ³ /s
Jun 7 Day 2 Year Low Flow	0.0662	ft ³ /s
Jun 7 Day 10 Year Low Flow	0.0451	ft ³ /s
Mar 7 Day 2 Year Low Flow	0.393	ft ³ /s
Mar 7 Day 10 Year Low Flow	0.218	ft ³ /s
May 7 Day 2 Year Low Flow	0.174	ft ³ /s
May 7 Day 10 Year Low Flow	0.128	ft ³ /s
Nov 7 Day 2 Year Low Flow	0.0974	ft ³ /s
Nov 7 Day 10 Year Low Flow	0.0398	ft ³ /s
Oct 7 Day 2 Year Low Flow	0.00963	ft ³ /s
Oct 7 Day 10 Year Low Flow	0.00435	ft ³ /s
Sep 7 Day 2 Year Low Flow	0.00926	ft ³ /s
Sep 7 Day 10 Year Low Flow	0.0039	ft ³ /s

Monthly Flow Statistics Citations

Risley, John, Stonewall, Adam, and Haluska, Tana, 2008, Estimating flow-duration and low-flow frequency statistics for unregulated streams in Oregon: U.S. Geological Survey Scientific Investigations Report 2008-5126, 22 p. (<http://pubs.usgs.gov/sir/2008/5126/>)

January Flow-Duration Statistics Parameters^{(100 Percent (0.181 square miles) LowFlow Jan Region01 2008 5126)}

Parameter Code	Parameter Name	Value	Units	Min Limit	Max Limit
DRNAREA	Drainage Area	0.18	square miles	0.367	673.359
IMPERV	Percent Impervious	8.15	percent	0	2.961
PRECIP	Mean Annual Precipitation	48.6	inches	65.5923	151.2906

January Flow-Duration Statistics Disclaimers^{(100 Percent (0.181 square miles) LowFlow Jan Region01 2008 5126)}

One or more of the parameters is outside the suggested range. Estimates were extrapolated with unknown errors

January Flow-Duration Statistics Flow Report^{(100 Percent (0.181 square miles) LowFlow Jan Region01 2008 5126)}

Statistic	Value	Unit
January 5 Percent Duration	3.55	ft ³ /s
January 10 Percent Duration	2.55	ft ³ /s
January 25 Percent Duration	1.36	ft ³ /s
January 50 Percent Duration	0.958	ft ³ /s
January 95 Percent Duration	0.203	ft ³ /s

January Flow-Duration Statistics Citations

Risley, John, Stonewall, Adam, and Haluska, Tana,2008, Estimating flow-duration and low-flow frequency statistics for unregulated streams in Oregon: U.S. Geological Survey Scientific Investigations Report 2008-5126, 22 p. (<http://pubs.usgs.gov/sir/2008/5126/>)

February Flow-Duration Statistics Parameters[100 Percent (0.181 square miles) LowFlow Feb Region01 2008 5126]

Parameter Code	Parameter Name	Value	Units	Min Limit	Max Limit
DRNAREA	Drainage Area	0.18	square miles	0.367	673.359
IMPERV	Percent Impervious	8.15	percent	0	2.961
PRECIP	Mean Annual Precipitation	48.6	inches	65.5923	151.2906
BSLOPD	Mean Basin Slope degrees	4.68	degrees	10.382	25.482

February Flow-Duration Statistics Disclaimers[100 Percent (0.181 square miles) LowFlow Feb Region01 2008 5126]

One or more of the parameters is outside the suggested range. Estimates were extrapolated with unknown errors

February Flow-Duration Statistics Flow Report[100 Percent (0.181 square miles) LowFlow Feb Region01 2008 5126]

Statistic	Value	Unit
February 5 Percent Duration	1.05	ft ³ /s
February 10 Percent Duration	0.973	ft ³ /s
February 25 Percent Duration	0.8	ft ³ /s
February 50 Percent Duration	0.758	ft ³ /s
February 95 Percent Duration	0.233	ft ³ /s

February Flow-Duration Statistics Citations

Risley, John, Stonewall, Adam, and Haluska, Tana,2008, Estimating flow-duration and low-flow frequency statistics for unregulated streams in Oregon: U.S. Geological Survey Scientific Investigations Report 2008-5126, 22 p. (<http://pubs.usgs.gov/sir/2008/5126/>)

March Flow-Duration Statistics Parameters[100 Percent (0.181 square miles) LowFlow Mar Region01 2008 5126]

Parameter Code	Parameter Name	Value	Units	Min Limit	Max Limit
DRNAREA	Drainage Area	0.18	square miles	0.367	673.359
IMPERV	Percent Impervious	8.15	percent	0	2.961
PRECIP	Mean Annual Precipitation	48.6	inches	65.5923	151.2906
BSLOPD	Mean Basin Slope degrees	4.68	degrees	10.382	25.482

March Flow-Duration Statistics Disclaimers[100 Percent (0.181 square miles) LowFlow Mar Region01 2008 5126]

One or more of the parameters is outside the suggested range. Estimates were extrapolated with unknown errors

March Flow-Duration Statistics Flow Report[100 Percent (0.181 square miles) LowFlow Mar Region01 2008 5126]

Statistic	Value	Unit
March 5 Percent Duration	0.947	ft ³ /s
March 10 Percent Duration	0.826	ft ³ /s
March 25 Percent Duration	0.621	ft ³ /s
March 50 Percent Duration	0.412	ft ³ /s
March 95 Percent Duration	0.21	ft ³ /s

March Flow-Duration Statistics Citations

Risley, John, Stonewall, Adam, and Haluska, Tana,2008, Estimating flow-duration and low-flow frequency statistics for unregulated streams in Oregon: U.S. Geological Survey Scientific Investigations Report 2008-5126, 22 p. (<http://pubs.usgs.gov/sir/2008/5126/>)

April Flow-Duration Statistics Parameters[100 Percent (0.181 square miles) LowFlow Apr Region01 2008 5126]

Parameter Code	Parameter Name	Value	Units	Min Limit	Max Limit
DRNAREA	Drainage Area	0.18	square miles	0.367	673.359
PRECIP	Mean Annual Precipitation	48.6	inches	65.5923	151.2906
BSLOPD	Mean Basin Slope degrees	4.68	degrees	10.382	25.482

April Flow-Duration Statistics Disclaimers[100 Percent (0.181 square miles) LowFlow Apr Region01 2008 5126]

One or more of the parameters is outside the suggested range. Estimates were extrapolated with unknown errors

April Flow-Duration Statistics Flow Report[100 Percent (0.181 square miles) LowFlow Apr Region01 2008 5126]

Statistic	Value	Unit
April 5 Percent Duration	0.661	ft ³ /s
April 10 Percent Duration	0.523	ft ³ /s
April 25 Percent Duration	0.321	ft ³ /s
April 50 Percent Duration	0.208	ft ³ /s
April 95 Percent Duration	0.152	ft ³ /s

April Flow-Duration Statistics Citations

Risley, John, Stonewall, Adam, and Haluska, Tana, 2008, Estimating flow-duration and low-flow frequency statistics for unregulated streams in Oregon: U.S. Geological Survey Scientific Investigations Report 2008-5126, 22 p. (<http://pubs.usgs.gov/sir/2008/5126/>)

May Flow-Duration Statistics Parameters[100 Percent (0.181 square miles) LowFlow May Region01 2008 5126]

Parameter Code	Parameter Name	Value	Units	Min Limit	Max Limit
DRNAREA	Drainage Area	0.18	square miles	1.953	673.359
PRECIP	Mean Annual Precipitation	48.6	inches	65.5923	151.2906
BSLOPD	Mean Basin Slope degrees	4.68	degrees	10.382	25.482
WATCAPORR	Available_Water_Capacity_OR_Risley	0.11	inch per inch	0.12	0.23

May Flow-Duration Statistics Disclaimers[100 Percent (0.181 square miles) LowFlow May Region01 2008 5126]

One or more of the parameters is outside the suggested range. Estimates were extrapolated with unknown errors

May Flow-Duration Statistics Flow Report[100 Percent (0.181 square miles) LowFlow May Region01 2008 5126]

Statistic	Value	Unit
May 5 Percent Duration	0.193	ft ³ /s
May 10 Percent Duration	0.163	ft ³ /s
May 25 Percent Duration	0.123	ft ³ /s
May 50 Percent Duration	0.0732	ft ³ /s
May 95 Percent Duration	0.0515	ft ³ /s

May Flow-Duration Statistics Citations

Risley, John, Stonewall, Adam, and Haluska, Tana, 2008, Estimating flow-duration and low-flow frequency statistics for unregulated streams in Oregon: U.S. Geological Survey Scientific Investigations Report 2008-5126, 22 p. (<http://pubs.usgs.gov/sir/2008/5126/>)

June Flow-Duration Statistics Parameters[100 Percent (0.181 square miles) LowFlow Jun Region01 2008 5126]

Parameter Code	Parameter Name	Value	Units	Min Limit	Max Limit
DRNAREA	Drainage Area	0.18	square miles	0.367	673.359
PRECIP	Mean Annual Precipitation	48.6	inches	65.5923	151.2906
BSLOPD	Mean Basin Slope degrees	4.68	degrees	10.382	25.482
WATCAPORR	Available_Water_Capacity_OR_Risley	0.11	inch per inch	0.12	0.23

June Flow-Duration Statistics Disclaimers[100 Percent (0.181 square miles) LowFlow Jun Region01 2008 5126]

One or more of the parameters is outside the suggested range. Estimates were extrapolated with unknown errors

June Flow-Duration Statistics Flow Report[100 Percent (0.181 square miles) LowFlow Jun Region01 2008 5126]

Statistic	Value	Unit
June 5 Percent Duration	0.122	ft ³ /s
June 10 Percent Duration	0.0789	ft ³ /s
June 25 Percent Duration	0.0422	ft ³ /s
June 50 Percent Duration	0.0335	ft ³ /s
June 95 Percent Duration	0.0437	ft ³ /s

June Flow-Duration Statistics Citations

Risley, John, Stonewall, Adam, and Haluska, Tana,2008, Estimating flow-duration and low-flow frequency statistics for unregulated streams in Oregon: U.S. Geological Survey Scientific Investigations Report 2008-5126, 22 p. (<http://pubs.usgs.gov/sir/2008/5126/>)

July Flow-Duration Statistics Parameters[100 Percent (0.181 square miles) LowFlow Jul Region01 2008 5126]

Parameter Code	Parameter Name	Value	Units	Min Limit	Max Limit
DRNAREA	Drainage Area	0.18	square miles	0.367	673.359
PRECIP	Mean Annual Precipitation	48.6	inches	65.5923	151.2906
WATCAPORR	Available_Water_Capacity_OR_Risley	0.11	inch per inch	0.12	0.23
BSLOPD	Mean Basin Slope degrees	4.68	degrees	10.382	25.482

July Flow-Duration Statistics Disclaimers[100 Percent (0.181 square miles) LowFlow Jul Region01 2008 5126]

One or more of the parameters is outside the suggested range. Estimates were extrapolated with unknown errors

July Flow-Duration Statistics Flow Report[100 Percent (0.181 square miles) LowFlow Jul Region01 2008 5126]

Statistic	Value	Unit
July 5 Percent Duration	0.0882	ft ³ /s
July 10 Percent Duration	0.0713	ft ³ /s
July 25 Percent Duration	0.0502	ft ³ /s
July 50 Percent Duration	0.0148	ft ³ /s
July 95 Percent Duration	0.00532	ft ³ /s

July Flow-Duration Statistics Citations

Risley, John, Stonewall, Adam, and Haluska, Tana,2008, Estimating flow-duration and low-flow frequency statistics for unregulated streams in Oregon: U.S. Geological Survey Scientific Investigations Report 2008-5126, 22 p. (<http://pubs.usgs.gov/sir/2008/5126/>)

August Flow-Duration Statistics Parameters[100 Percent (0.181 square miles) LowFlow Aug Region01 2008 5126]

Parameter Code	Parameter Name	Value	Units	Min Limit	Max Limit
DRNAREA	Drainage Area	0.18	square miles	0.367	673.359
MINBELEV	Minimum Basin Elevation	198	feet	10.5648	1381.5307
PRECIP	Mean Annual Precipitation	48.6	inches	65.5923	151.2906

August Flow-Duration Statistics Disclaimers[100 Percent (0.181 square miles) LowFlow Aug Region01 2008 5126]

One or more of the parameters is outside the suggested range. Estimates were extrapolated with unknown errors

August Flow-Duration Statistics Flow Report[100 Percent (0.181 square miles) LowFlow Aug Region01 2008 5126]

Statistic	Value	Unit
August 5 Percent Duration	0.0581	ft ³ /s

Statistic	Value	Unit
August 10 Percent Duration	0.0333	ft ³ /s
August 25 Percent Duration	0.0266	ft ³ /s
August 50 Percent Duration	0.0204	ft ³ /s
August 95 Percent Duration	0.00638	ft ³ /s

August Flow-Duration Statistics Citations

Risley, John, Stonewall, Adam, and Haluska, Tana, 2008, Estimating flow-duration and low-flow frequency statistics for unregulated streams in Oregon: U.S. Geological Survey Scientific Investigations Report 2008-5126, 22 p. (<http://pubs.usgs.gov/sir/2008/5126/>)

September Flow-Duration Statistics Parameters[100 Percent (0.181 square miles) LowFlow Sep Region01 2008 5126]

Parameter Code	Parameter Name	Value	Units	Min Limit	Max Limit
DRNAREA	Drainage Area	0.18	square miles	0.367	590.347
MINBELEV	Minimum Basin Elevation	198	feet	10.5648	1381.5307
PRECIP	Mean Annual Precipitation	48.6	inches	65.5923	151.2906

September Flow-Duration Statistics Disclaimers[100 Percent (0.181 square miles) LowFlow Sep Region01 2008 5126]

One or more of the parameters is outside the suggested range. Estimates were extrapolated with unknown errors

September Flow-Duration Statistics Flow Report[100 Percent (0.181 square miles) LowFlow Sep Region01 2008 5126]

Statistic	Value	Unit
September 5 Percent Duration	0.0607	ft ³ /s
September 10 Percent Duration	0.0431	ft ³ /s
September 25 Percent Duration	0.027	ft ³ /s
September 50 Percent Duration	0.0126	ft ³ /s
September 95 Percent Duration	0.0035	ft ³ /s

September Flow-Duration Statistics Citations

Risley, John, Stonewall, Adam, and Haluska, Tana, 2008, Estimating flow-duration and low-flow frequency statistics for unregulated streams in Oregon: U.S. Geological Survey Scientific Investigations Report 2008-5126, 22 p. (<http://pubs.usgs.gov/sir/2008/5126/>)

October Flow-Duration Statistics Parameters[100 Percent (0.181 square miles) LowFlow Oct Region01 2008 5126]

Parameter Code	Parameter Name	Value	Units	Min Limit	Max Limit
DRNAREA	Drainage Area	0.18	square miles	0.367	219.691
ELEV	Mean Basin Elevation	326	feet	520.406	2101.874
PRECIP	Mean Annual Precipitation	48.6	inches	71.6651	143.4891

October Flow-Duration Statistics Disclaimers[100 Percent (0.181 square miles) LowFlow Oct Region01 2008 5126]

One or more of the parameters is outside the suggested range. Estimates were extrapolated with unknown errors

October Flow-Duration Statistics Flow Report[100 Percent (0.181 square miles) LowFlow Oct Region01 2008 5126]

Statistic	Value	Unit
October 5 Percent Duration	0.289	ft ³ /s
October 10 Percent Duration	0.184	ft ³ /s
October 25 Percent Duration	0.0696	ft ³ /s
October 50 Percent Duration	0.0203	ft ³ /s
October 95 Percent Duration	0.00605	ft ³ /s

October Flow-Duration Statistics Citations

Risley, John, Stonewall, Adam, and Haluska, Tana, 2008, Estimating flow-duration and low-flow frequency statistics for unregulated streams in Oregon: U.S. Geological Survey Scientific Investigations Report 2008-5126, 22 p. (<http://pubs.usgs.gov/sir/2008/5126/>)

November Flow-Duration Statistics Parameters(100 Percent (0.181 square miles) LowFlow Nov Region01 2008 5126)

Parameter Code	Parameter Name	Value	Units	Min Limit	Max Limit
DRNAREA	Drainage Area	0.18	square miles	0.367	673.359
PRECIP	Mean Annual Precipitation	48.6	inches	65.5923	151.2906
BSLOPD	Mean Basin Slope degrees	4.68	degrees	10.382	25.482
MAXBSLOPD	Maximum Basin Slope in deg	14.5	degrees	34.073	68.78

November Flow-Duration Statistics Disclaimers(100 Percent (0.181 square miles) LowFlow Nov Region01 2008 5126)

One or more of the parameters is outside the suggested range. Estimates were extrapolated with unknown errors

November Flow-Duration Statistics Flow Report(100 Percent (0.181 square miles) LowFlow Nov Region01 2008 5126)

Statistic	Value	Unit
November 5 Percent Duration	1.07	ft ³ /s
November 10 Percent Duration	0.782	ft ³ /s
November 25 Percent Duration	0.366	ft ³ /s
November 50 Percent Duration	0.134	ft ³ /s
November 95 Percent Duration	0.446	ft ³ /s

November Flow-Duration Statistics Citations

Risley, John, Stonewall, Adam, and Haluska, Tana, 2008, Estimating flow-duration and low-flow frequency statistics for unregulated streams in Oregon: U.S. Geological Survey Scientific Investigations Report 2008-5126, 22 p. (<http://pubs.usgs.gov/sir/2008/5126/>)

December Flow-Duration Statistics Parameters(100 Percent (0.181 square miles) LowFlow Dec Region01 2008 5126)

Parameter Code	Parameter Name	Value	Units	Min Limit	Max Limit
DRNAREA	Drainage Area	0.18	square miles	0.367	673.359
PRECIP	Mean Annual Precipitation	48.6	inches	65.5923	151.2906
BSLOPD	Mean Basin Slope degrees	4.68	degrees	10.382	25.482

December Flow-Duration Statistics Disclaimers(100 Percent (0.181 square miles) LowFlow Dec Region01 2008 5126)

One or more of the parameters is outside the suggested range. Estimates were extrapolated with unknown errors

December Flow-Duration Statistics Flow Report(100 Percent (0.181 square miles) LowFlow Dec Region01 2008 5126)

Statistic	Value	Unit
December 5 Percent Duration	1.4	ft ³ /s
December 10 Percent Duration	1.35	ft ³ /s
December 25 Percent Duration	1.45	ft ³ /s
December 50 Percent Duration	0.746	ft ³ /s
December 95 Percent Duration	0.1	ft ³ /s

December Flow-Duration Statistics Citations

Risley, John, Stonewall, Adam, and Haluska, Tana, 2008, Estimating flow-duration and low-flow frequency statistics for unregulated streams in Oregon: U.S. Geological Survey Scientific Investigations Report 2008-5126, 22 p. (<http://pubs.usgs.gov/sir/2008/5126/>)

USGS Data Disclaimer: Unless otherwise stated, all data, metadata and related materials are considered to satisfy the quality standards relative to the purpose for which the data were collected. Although these data and associated metadata have been reviewed for accuracy and completeness and approved for release by the U.S. Geological Survey (USGS), no warranty expressed or implied is made regarding the display or utility of the data for other purposes, nor on all computer systems, nor shall the act of distribution constitute any such warranty.

USGS Software Disclaimer: This software has been approved for release by the U.S. Geological Survey (USGS). Although the software has been subjected to rigorous review, the USGS reserves the right to update the software as needed pursuant to further analysis and review. No warranty, expressed or implied, is made by the USGS or the U.S. Government as to the functionality of the software and related material nor shall the fact of release constitute any such warranty. Furthermore, the software is released on condition that neither the USGS nor the U.S. Government shall be held liable for any damages resulting from its authorized or unauthorized use.

USGS Product Names Disclaimer: Any use of trade, firm, or product names is for descriptive purposes only and does not imply endorsement by the U.S. Government.

Application Version: 4.4.0



Intermittent Stream D
Stream Function Assessment Method (SFAM)
Report



Report Generated: November 3, 2020 08:10 AM

Location Information

Latitude	45.8702 N	Longitude	-122.8179 W
Elevation	182 ft	Level III Ecoregion	Willamette Valley
HUC8	17080003 Lower Columbia-Clatskanie		
HUC10	1708000304 Beaver Creek-Frontal Columbia River		
HUC12	170800030401 Deer Island Slough-Frontal Columbia River		
Linear ft of stream in HUC8	216,535	Annual precipitation	44 in

Stream Type and Classifications

No results

Stream classifications and associated attributes are derived from a U.S. Environmental Protection Agency stream classification geospatial data layer developed for Oregon (2015). This layer provides a statewide stream/watershed classification system for streams and rivers of various sizes, based in part on a hydrologic landscape classification system.

Report Generated: November 3, 2020 08:10 AM

Rare Species Scores and Special Habitat Designations

Rare Species Type	Maximum score	Sum Score	Rating
Non-anadromous Fish Species	0	0	None
Amphibian & Reptile Species	0	0	None
Feeding Waterbirds	0	0	None
Songbirds, Raptors, and Mammals	0	0	None
Invertebrate Species	0	0	None
Plant Species	0	0	None

Scores have taken into account several factors for each rare species record contained in the official database of the Oregon Biodiversity Information Center (ORBIC): (a) the regional rarity of the species, (b) their proximity to the point of interest, and (c) the “certainty” that ORBIC assigns to each of those records.

Within 300 ft of a Special Protected Area?	No
Within a HUC12 that has designated Essential Salmonid Habitat?	Yes
Within 2 miles of an Important Bird Area?	No

Water Quality Impairments

Query returned no records.

Water quality information is derived from Oregon’s 2012 Integrated Report, including the list of water quality limited waters needing Total Maximum Daily Loads (303d List). Each record in the report is assigned an assessment category based on an evaluation of water quality information. Categories included in the SFAM Report are:

Category 5: Water is water quality limited and a TMDL is needed; Section 303(d) list.

Category 4: Water is impaired or threatened but a TMDL is not needed because: (A) the TMDL is approved, (B) other pollution requirements are in place, or (C) the impairment (such as flow or lack of flow)



Stream Function Assessment Method (SFAM)
Report



Report Generated: November 3, 2020 08:10 AM

is not caused by a pollutant.

Category 3B: Water quality is of potential concern; some data indicate non-attainment of a criterion, but data are insufficient to assign another category.

Dominant soil type(s)			
Soil Type	Erosion Hazard Rating	Hydric Rating	Percent Area
Rock outcrop-Xerumbrepts complex, undulating	Not rated	No	100.00%

This report contains both centroid-based and polygon-based data. The Location Information section of the report contains centroid-based data (determined by the center point of the polygon), while the remaining sections are polygon-based (determined from the entire polygon).

Intermittent Stream D

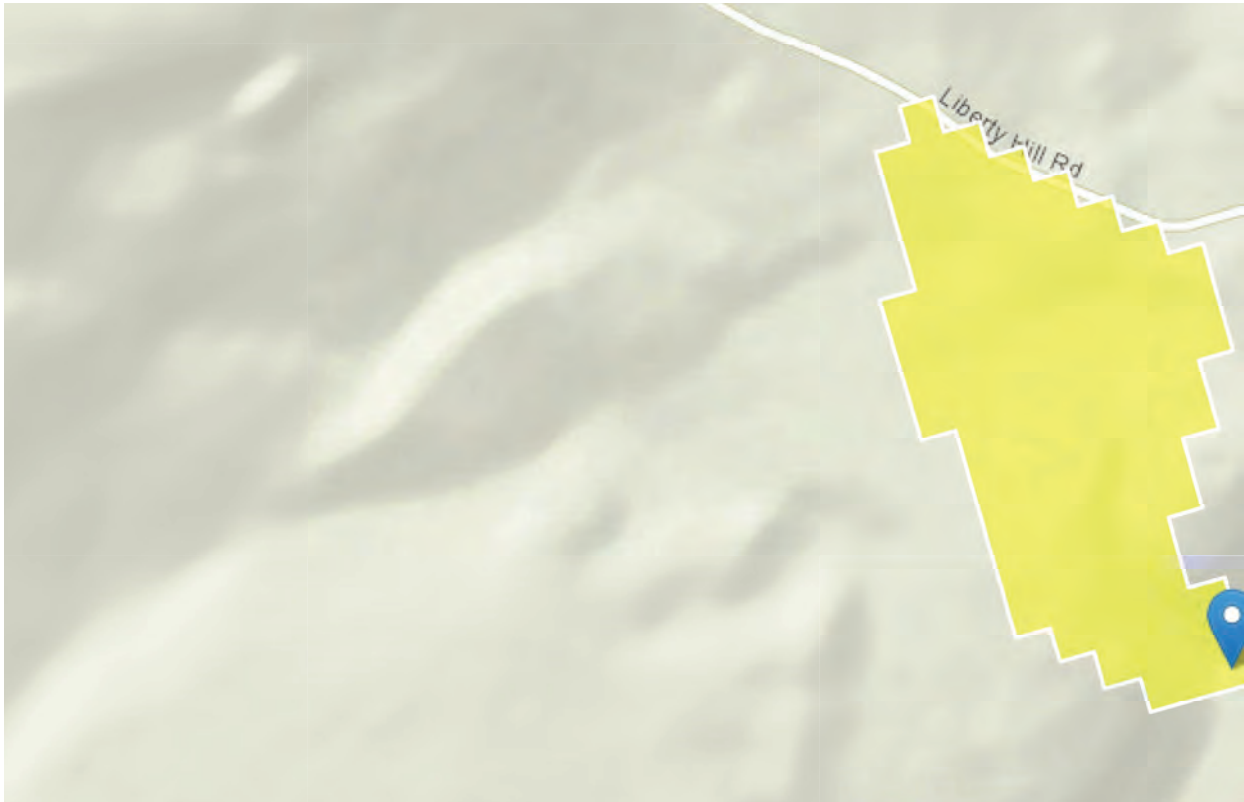
StreamStats Report

Region ID: OR

Workspace ID: OR20201103161504729000

Clicked Point (Latitude, Longitude): 45.87025, -122.81785

Time: 2020-11-03 08:15:23 -0800



Basin Characteristics

Parameter Code	Parameter Description	Value	Unit
DRNAREA	Area that drains to a point on a stream	0.0354	square miles
I24H2Y	Maximum 24-hour precipitation that occurs on average once in 2 years - Equivalent to precipitation intensity index	1.77	inches
SOILPERM	Average Soil Permeability	2.2	inches per hour

Parameter Code	Parameter Description	Value	Unit
JANMAXT2K	Mean Maximum January Temperature from 2K resolution PRISM 1961-1990 data	45.1	degrees F
WATCAPORC	Available water capacity from STATSGO data using methods from SIR 2005-5116	0.11	inches
ORREG2	Oregon Region Number	10001	dimensionless
BSLOPD	Mean basin slope measured in degrees	3.71	degrees
JANMINT2K	Mean Minimum January Temperature from 2K resolution PRISM PRISM 1961-1990 data	32.4	degrees F
ELEV	Mean Basin Elevation	230	feet
PRECIP	Mean Annual Precipitation	48	inches
WATCAPORR	Available water capacity from STATSGO data using methods from SIR 2008-5126	0.11	inch per inch
JANMINTMP	Mean Minimum January Temperature	32.4	degrees F
ASPECT	basin average of topographic slope compass directions from elevation grid	171	degrees
DRNDENSITY	Basin drainage density defined as total stream length divided by drainage area.	0	dimensionless
ELEVMAX	Maximum basin elevation	271	feet
FOREST	Percentage of area covered by forest	26.5	percent
IMPERV	Percentage of impervious area	26.5	percent
JANAVPRE2K	Mean January Precipitation	6.97	inches
JANMAXTMP	Mean Maximum January Temperature	44.8	degrees F
JULAVPRE2K	Mean July Average Precipitation	0.63	inches
LC11BARE	Percentage of barren from NLCD 2011 class 31	0	percent
LC11CRPHAY	Percentage of cultivated crops and hay, classes 81 and 82, from NLCD 2011	60	percent
LC11DEVHI	Percentage of area developed, high intensity, NLCD 2011 class 24	0	percent

Parameter Code	Parameter Description	Value	Unit
LC11DVLO	Percentage of developed area, low intensity, from NLCD 2011 class 22	1	percent
LC11DVMD	Percentage of area developed, medium intensity, NLCD 2011 class 23	0	percent
LC11DVOPN	Percentage of developed open area from NLCD 2011 class 21	11	percent
STRMTOT	total length of all mapped streams (1:24,000-scale) in the basin	0	miles
STATSGODEP	Area-weighted average soil depth from NRCS STATSGO database	45	inches
STATE_HWY	Length of state highways in basin	0	miles
RELIEF	Maximum - minimum elevation	147	feet
OR_HIPERMG	Percent basin surface area containing high permeability geologic units as defined in SIR 2008-5126	0	percent
OR_HIPERMA	Percent basin surface area containing high permeability aquifer units as defined in SIR 2008-5126	0	percent
MIN_ROADS	Length of non-state minor roads in basin	0.061	miles
MINTEMP	Mean annual minimum air temperature over basin surface area as defined in SIR 2008-5126	41.7	degrees F
MINBSLOPD	Minimum basin slope, in degrees, using ArcInfo Grid with NHDPlus 30-m resolution elevation data.	0.17	degrees
MINBELEV	Minimum basin elevation	124	feet
MAXTEMP	Mean annual maximum air temperature over basin area from PRISM 1971-2000 800-m grid	61.7	degrees F
MAXBSLOPD	Maximum basin slope, in degrees, using ArcInfo Grid with NHDPlus 30-m resolution elevation data.	18.4	degrees
MAJ_ROADS	Length of non-state major roads in basin	0	miles

Parameter Code	Parameter Description	Value	Unit
LC11WETLND	Percentage of wetlands, classes 90 and 95, from NLCD 2011	0	percent
LC11WATER	Percent of open water, class 11, from NLCD 2011	0	percent
LC11IMP	Average percentage of impervious area determined from NLCD 2011 impervious dataset	1.56	percent
LC11HERB	Percentage of herbaceous from NLCD 2011 classes 71-74	0	percent
LC11FORSHB	Percentage of forests and shrub lands, classes 41 to 52, from NLCD 2011	28	percent

Peak-Flow Statistics Parameters^[Reg 2B Western Interior LT 3000 ft Cooper]

Parameter Code	Parameter Name	Value	Units	Min Limit	Max Limit
DRNAREA	Drainage Area	0.0354	square miles	0.37	7270
BSLOPD	Mean Basin Slope degrees	3.71	degrees	5.62	28.3
I24H2Y	24 Hour 2 Year Precipitation	1.77	inches	1.53	4.48
ELEV	Mean Basin Elevation	230	feet		
ORREG2	Oregon Region Number	10001	dimensionless		

Peak-Flow Statistics Disclaimers^[Reg 2B Western Interior LT 3000 ft Cooper]

One or more of the parameters is outside the suggested range. Estimates were extrapolated with unknown errors

Peak-Flow Statistics Flow Report^[Reg 2B Western Interior LT 3000 ft Cooper]

Statistic	Value	Unit
2 Year Peak Flood	1.35	ft ³ /s

Statistic	Value	Unit
5 Year Peak Flood	2.01	ft ³ /s
10 Year Peak Flood	2.46	ft ³ /s
25 Year Peak Flood	3.04	ft ³ /s
50 Year Peak Flood	3.47	ft ³ /s
100 Year Peak Flood	3.91	ft ³ /s
500 Year Peak Flood	4.93	ft ³ /s

Peak-Flow Statistics Citations

Cooper, R.M.,2005, Estimation of Peak Discharges for Rural, Unregulated Streams in Western Oregon: U.S. Geological Survey Scientific Investigations Report 2005-5116, 76 p. (<http://pubs.usgs.gov/sir/2005/5116/pdf/sir2005-5116.pdf>)

Low-Flow Statistics Parameters[LowFlow Ann Region01 2008 5126]

Parameter Code	Parameter Name	Value	Units	Min Limit	Max Limit
DRNAREA	Drainage Area	0.0354	square miles	0.367	590.34
PRECIP	Mean Annual Precipitation	48	inches	65.5923	122.98
WATCAPORR	Available_Water_Capacity_OR_Risley	0.11	inch per inch	0.12	0.23

Low-Flow Statistics Disclaimers[LowFlow Ann Region01 2008 5126]

One or more of the parameters is outside the suggested range. Estimates were extrapolated with unknown errors

Low-Flow Statistics Flow Report[LowFlow Ann Region01 2008 5126]

Statistic	Value	Unit
7 Day 2 Year Low Flow	0.00161	ft ³ /s
7 Day 10 Year Low Flow	0.000748	ft ³ /s

Low-Flow Statistics Citations

Risley, John, Stonewall, Adam, and Haluska, Tana,2008, Estimating flow-duration and low-flow frequency statistics for unregulated streams in Oregon: U.S. Geological Survey Scientific Investigations Report 2008-5126, 22 p. (<http://pubs.usgs.gov/sir/2008/5126/>)

Flow-Duration Statistics Parameters^[LowFlow Ann Region01 2008 5126]

Parameter Code	Parameter Name	Value	Units	Min Limit	Max Limit
DRNAREA	Drainage Area	0.0354	square miles	0.367	590.34
PRECIP	Mean Annual Precipitation	48	inches	65.5923	122.98
WATCAPORR	Available_Water_Capacity_OR_Risley	0.11	inch per inch	0.12	0.23

Flow-Duration Statistics Disclaimers^[LowFlow Ann Region01 2008 5126]

One or more of the parameters is outside the suggested range. Estimates were extrapolated with unknown errors

Flow-Duration Statistics Flow Report^[LowFlow Ann Region01 2008 5126]

Statistic	Value	Unit
5 Percent Duration	0.386	ft ³ /s
10 Percent Duration	0.246	ft ³ /s
25 Percent Duration	0.103	ft ³ /s
50 Percent Duration	0.0308	ft ³ /s
95 Percent Duration	0.00172	ft ³ /s

Flow-Duration Statistics Citations

Risley, John, Stonewall, Adam, and Haluska, Tana,2008, Estimating flow-duration and low-flow frequency statistics for unregulated streams in Oregon: U.S.

Geological Survey Scientific Investigations Report 2008-5126, 22 p.
 (<http://pubs.usgs.gov/sir/2008/5126/>)

Monthly Flow Statistics Parameters_[LowFlow Apr Region01 2008 5126]

Parameter Code	Parameter Name	Value	Units	Min Limit	Max Limit
DRNAREA	Drainage Area	0.0354	square miles	0.367	673.359
PRECIP	Mean Annual Precipitation	48	inches	65.5923	151.2906

Monthly Flow Statistics Parameters_[LowFlow Aug Region01 2008 5126]

Parameter Code	Parameter Name	Value	Units	Min Limit	Max Limit
DRNAREA	Drainage Area	0.0354	square miles	0.367	673.359
JANMINTMP	Mean Min January Temperature	32.4	degrees F	30.678	34.661
PRECIP	Mean Annual Precipitation	48	inches	65.5923	151.2906

Monthly Flow Statistics Parameters_[LowFlow Dec Region01 2008 5126]

Parameter Code	Parameter Name	Value	Units	Min Limit	Max Limit
DRNAREA	Drainage Area	0.0354	square miles	0.367	673.359
PRECIP	Mean Annual Precipitation	48	inches	65.5923	151.2906

Monthly Flow Statistics Parameters_[LowFlow Feb Region01 2008 5126]

Parameter Code	Parameter Name	Value	Units	Min Limit	Max Limit
DRNAREA	Drainage Area	0.0354	square miles	0.367	673.359

Parameter Code	Parameter Name	Value	Units	Min Limit	Max Limit
PRECIP	Mean Annual Precipitation	48	inches	65.5923	151.2906

Monthly Flow Statistics Parameters[LowFlow Jan Region01 2008 5126]

Parameter Code	Parameter Name	Value	Units	Min Limit	Max Limit
DRNAREA	Drainage Area	0.0354	square miles	0.367	673.359
PRECIP	Mean Annual Precipitation	48	inches	65.5923	151.2906

Monthly Flow Statistics Parameters[LowFlow Jul Region01 2008 5126]

Parameter Code	Parameter Name	Value	Units	Min Limit	Max Limit
DRNAREA	Drainage Area	0.0354	square miles	0.367	673.359
JANMINTMP	Mean Min January Temperature	32.4	degrees F	30.678	34.661
PRECIP	Mean Annual Precipitation	48	inches	65.5923	151.2906

Monthly Flow Statistics Parameters[LowFlow Jun Region01 2008 5126]

Parameter Code	Parameter Name	Value	Units	Min Limit	Max Limit
DRNAREA	Drainage Area	0.0354	square miles	0.367	673.359
PRECIP	Mean Annual Precipitation	48	inches	65.5923	151.2906

Monthly Flow Statistics Parameters[LowFlow Mar Region01 2008 5126]

Parameter Code	Parameter Name	Value	Units	Min Limit	Max Limit
----------------	----------------	-------	-------	-----------	-----------

Parameter Code	Parameter Name	Value	Units	Min Limit	Max Limit
DRNAREA	Drainage Area	0.0354	square miles	0.367	673.359

PRECIP	Mean Annual Precipitation	48	inches	65.5923	151.2906
--------	---------------------------	----	--------	---------	----------

Monthly Flow Statistics Parameters[LowFlow May Region01 2008 5126]

Parameter Code	Parameter Name	Value	Units	Min Limit	Max Limit
DRNAREA	Drainage Area	0.0354	square miles	1.953	673.359

PRECIP	Mean Annual Precipitation	48	inches	65.5923	151.2906
--------	---------------------------	----	--------	---------	----------

Monthly Flow Statistics Parameters[LowFlow Nov Region01 2008 5126]

Parameter Code	Parameter Name	Value	Units	Min Limit	Max Limit
DRNAREA	Drainage Area	0.0354	square miles	0.367	673.359

ELEV	Mean Basin Elevation	230	feet	520.406	2101.874
------	----------------------	-----	------	---------	----------

PRECIP	Mean Annual Precipitation	48	inches	65.5923	151.2906
--------	---------------------------	----	--------	---------	----------

Monthly Flow Statistics Parameters[LowFlow Oct Region01 2008 5126]

Parameter Code	Parameter Name	Value	Units	Min Limit	Max Limit
DRNAREA	Drainage Area	0.0354	square miles	0.367	219.691

ELEV	Mean Basin Elevation	230	feet	520.406	2101.874
------	----------------------	-----	------	---------	----------

PRECIP	Mean Annual Precipitation	48	inches	71.6651	143.4891
--------	---------------------------	----	--------	---------	----------

Monthly Flow Statistics Parameters[LowFlow Sep Region01 2008 5126]

Parameter Code	Parameter Name	Value	Units	Min Limit	Max Limit
DRNAREA	Drainage Area	0.0354	square miles	0.367	590.347
PRECIP	Mean Annual Precipitation	48	inches	65.5923	151.2906

Monthly Flow Statistics Disclaimers^[LowFlow Apr Region01 2008 5126]

One or more of the parameters is outside the suggested range. Estimates were extrapolated with unknown errors

Monthly Flow Statistics Flow Report^[LowFlow Apr Region01 2008 5126]

Statistic	Value	Unit
Apr 7 Day 2 Year Low Flow	0.0438	ft ³ /s
Apr 7 Day 10 Year Low Flow	0.0243	ft ³ /s

Monthly Flow Statistics Disclaimers^[LowFlow Aug Region01 2008 5126]

One or more of the parameters is outside the suggested range. Estimates were extrapolated with unknown errors

Monthly Flow Statistics Flow Report^[LowFlow Aug Region01 2008 5126]

Statistic	Value	Unit
Aug 7 Day 2 Year Low Flow	0.00142	ft ³ /s
Aug 7 Day 10 Year Low Flow	0.000716	ft ³ /s

Monthly Flow Statistics Disclaimers^[LowFlow Dec Region01 2008 5126]

One or more of the parameters is outside the suggested range. Estimates were extrapolated with unknown errors

Monthly Flow Statistics Flow Report^[LowFlow Dec Region01 2008 5126]

Statistic	Value	Unit
Dec 7 Day 2 Year Low Flow	0.073	ft ³ /s

Statistic	Value	Unit
Dec 7 Day 10 Year Low Flow	0.0202	ft ³ /s

Monthly Flow Statistics Disclaimers_[LowFlow Feb Region01 2008 5126]

One or more of the parameters is outside the suggested range. Estimates were extrapolated with unknown errors

Monthly Flow Statistics Flow Report_[LowFlow Feb Region01 2008 5126]

Statistic	Value	Unit
Feb 7 Day 2 Year Low Flow	0.0847	ft ³ /s
Feb 7 Day 10 Year Low Flow	0.04	ft ³ /s

Monthly Flow Statistics Disclaimers_[LowFlow Jan Region01 2008 5126]

One or more of the parameters is outside the suggested range. Estimates were extrapolated with unknown errors

Monthly Flow Statistics Flow Report_[LowFlow Jan Region01 2008 5126]

Statistic	Value	Unit
Jan 7 Day 2 Year Low Flow	0.106	ft ³ /s
Jan 7 Day 10 Year Low Flow	0.0505	ft ³ /s

Monthly Flow Statistics Disclaimers_[LowFlow Jul Region01 2008 5126]

One or more of the parameters is outside the suggested range. Estimates were extrapolated with unknown errors

Monthly Flow Statistics Flow Report_[LowFlow Jul Region01 2008 5126]

Statistic	Value	Unit
Jul 7 Day 2 Year Low Flow	0.00241	ft ³ /s
Jul 7 Day 10 Year Low Flow	0.00152	ft ³ /s

Monthly Flow Statistics Disclaimers_[LowFlow Jun Region01 2008 5126]

One or more of the parameters is outside the suggested range. Estimates were extrapolated with unknown errors

Monthly Flow Statistics Flow Report^[LowFlow Jun Region01 2008 5126]

Statistic	Value	Unit
Jun 7 Day 2 Year Low Flow	0.0129	ft ³ /s
Jun 7 Day 10 Year Low Flow	0.00869	ft ³ /s

Monthly Flow Statistics Disclaimers^[LowFlow Mar Region01 2008 5126]

One or more of the parameters is outside the suggested range. Estimates were extrapolated with unknown errors

Monthly Flow Statistics Flow Report^[LowFlow Mar Region01 2008 5126]

Statistic	Value	Unit
Mar 7 Day 2 Year Low Flow	0.0761	ft ³ /s
Mar 7 Day 10 Year Low Flow	0.0422	ft ³ /s

Monthly Flow Statistics Disclaimers^[LowFlow May Region01 2008 5126]

One or more of the parameters is outside the suggested range. Estimates were extrapolated with unknown errors

Monthly Flow Statistics Flow Report^[LowFlow May Region01 2008 5126]

Statistic	Value	Unit
May 7 Day 2 Year Low Flow	0.0349	ft ³ /s
May 7 Day 10 Year Low Flow	0.026	ft ³ /s

Monthly Flow Statistics Disclaimers^[LowFlow Nov Region01 2008 5126]

One or more of the parameters is outside the suggested range. Estimates were extrapolated with unknown errors

Monthly Flow Statistics Flow Report^[LowFlow Nov Region01 2008 5126]

Statistic	Value	Unit
-----------	-------	------

Statistic	Value	Unit
Nov 7 Day 2 Year Low Flow	0.0209	ft ³ /s

Nov 7 Day 10 Year Low Flow	0.00876	ft ³ /s
----------------------------	---------	--------------------

Monthly Flow Statistics Disclaimers_[LowFlow Oct Region01 2008 5126]

One or more of the parameters is outside the suggested range. Estimates were extrapolated with unknown errors

Monthly Flow Statistics Flow Report_[LowFlow Oct Region01 2008 5126]

Statistic	Value	Unit
Oct 7 Day 2 Year Low Flow	0.00192	ft ³ /s

Oct 7 Day 10 Year Low Flow	0.000798	ft ³ /s
----------------------------	----------	--------------------

Monthly Flow Statistics Disclaimers_[LowFlow Sep Region01 2008 5126]

One or more of the parameters is outside the suggested range. Estimates were extrapolated with unknown errors

Monthly Flow Statistics Flow Report_[LowFlow Sep Region01 2008 5126]

Statistic	Value	Unit
Sep 7 Day 2 Year Low Flow	0.00158	ft ³ /s

Sep 7 Day 10 Year Low Flow	0.000588	ft ³ /s
----------------------------	----------	--------------------

Monthly Flow Statistics Flow Report_[Area-Averaged]

Statistic	Value	Unit
Apr 7 Day 2 Year Low Flow	0.0438	ft ³ /s

Apr 7 Day 10 Year Low Flow	0.0243	ft ³ /s
----------------------------	--------	--------------------

Aug 7 Day 2 Year Low Flow	0.00142	ft ³ /s
---------------------------	---------	--------------------

Aug 7 Day 10 Year Low Flow	0.000716	ft ³ /s
----------------------------	----------	--------------------

Dec 7 Day 2 Year Low Flow	0.073	ft ³ /s
---------------------------	-------	--------------------

Dec 7 Day 10 Year Low Flow	0.0202	ft ³ /s
----------------------------	--------	--------------------

Feb 7 Day 2 Year Low Flow	0.0847	ft ³ /s
---------------------------	--------	--------------------

Statistic	Value	Unit
Feb 7 Day 10 Year Low Flow	0.04	ft ³ /s
Jan 7 Day 2 Year Low Flow	0.106	ft ³ /s
Jan 7 Day 10 Year Low Flow	0.0505	ft ³ /s
Jul 7 Day 2 Year Low Flow	0.00241	ft ³ /s
Jul 7 Day 10 Year Low Flow	0.00152	ft ³ /s
Jun 7 Day 2 Year Low Flow	0.0129	ft ³ /s
Jun 7 Day 10 Year Low Flow	0.00869	ft ³ /s
Mar 7 Day 2 Year Low Flow	0.0761	ft ³ /s
Mar 7 Day 10 Year Low Flow	0.0422	ft ³ /s
May 7 Day 2 Year Low Flow	0.0349	ft ³ /s
May 7 Day 10 Year Low Flow	0.026	ft ³ /s
Nov 7 Day 2 Year Low Flow	0.0209	ft ³ /s
Nov 7 Day 10 Year Low Flow	0.00876	ft ³ /s
Oct 7 Day 2 Year Low Flow	0.00192	ft ³ /s
Oct 7 Day 10 Year Low Flow	0.000798	ft ³ /s
Sep 7 Day 2 Year Low Flow	0.00158	ft ³ /s
Sep 7 Day 10 Year Low Flow	0.000588	ft ³ /s
<i>Monthly Flow Statistics Citations</i>		
<p>Risley, John, Stonewall, Adam, and Haluska, Tana, 2008, Estimating flow-duration and low-flow frequency statistics for unregulated streams in Oregon: U.S. Geological Survey Scientific Investigations Report 2008-5126, 22 p. (http://pubs.usgs.gov/sir/2008/5126/)</p>		

USGS Data Disclaimer: Unless otherwise stated, all data, metadata and related materials are considered to satisfy the quality standards relative to the purpose for which the data were collected. Although these data and associated metadata have been reviewed for accuracy and completeness and approved for release by the U.S. Geological Survey (USGS), no warranty expressed or implied is made regarding the display or utility of the data for other purposes, nor on all computer systems, nor shall the act of distribution constitute any such warranty.

USGS Software Disclaimer: This software has been approved for release by the U.S. Geological Survey (USGS). Although the software has been subjected to rigorous review, the USGS reserves the right to update the software as needed pursuant to further analysis and review. No warranty, expressed or implied, is made by the USGS or the U.S. Government as to the functionality of the software and related material nor shall the fact of release constitute any such warranty. Furthermore, the software is released on condition that neither the USGS nor the U.S. Government shall be held liable for any damages resulting from its authorized or unauthorized use.

USGS Product Names Disclaimer: Any use of trade, firm, or product names is for descriptive purposes only and does not imply endorsement by the U.S. Government.

Application Version: 4.4.0



Perennial Stream 1-A
Stream Function Assessment Method (SFAM)
Report



Report Generated: April 6, 2022 03:07 AM

Location Information

Latitude	45.8745 N	Longitude	-122.8224 W
Elevation	273 ft	Level III Ecoregion	Willamette Valley
HUC8	17080003 Lower Columbia-Clatskanie		
HUC10	1708000304 Beaver Creek-Frontal Columbia River		
HUC12	170800030401 Deer Island Slough-Frontal Columbia River		
Linear ft of stream in HUC8	216,535	Annual precipitation	46 in

Stream Type and Classifications

No results

Stream classifications and associated attributes are derived from a U.S. Environmental Protection Agency stream classification geospatial data layer developed for Oregon (2015). This layer provides a statewide stream/watershed classification system for streams and rivers of various sizes, based in part on a hydrologic landscape classification system.

Report Generated: April 6, 2022 03:07 AM

Rare Species Scores and Special Habitat Designations

Rare Species Type	Maximum score	Sum Score	Rating
Non-anadromous Fish Species	0	0	None
Amphibian & Reptile Species	0	0	None
Feeding Waterbirds	0	0	None
Songbirds, Raptors, and Mammals	0	0	None
Invertebrate Species	0	0	None
Plant Species	0	0	None

Scores have taken into account several factors for each rare species record contained in the official database of the Oregon Biodiversity Information Center (ORBIC): (a) the regional rarity of the species, (b) their proximity to the point of interest, and (c) the “certainty” that ORBIC assigns to each of those records.

Within 300 ft of a Special Protected Area?	No
Within a HUC12 that has designated Essential Salmonid Habitat?	Yes
Within 2 miles of an Important Bird Area?	No

Water Quality Impairments

Water quality information is derived from Oregon’s 2012 Integrated Report, including the list of water quality limited waters needing Total Maximum Daily Loads (303d List). Each record in the report is assigned an assessment category based on an evaluation of water quality information. Categories included in the SFAM Report are:

Category 5: Water is water quality limited and a TMDL is needed; Section 303(d) list.

Category 4: Water is impaired or threatened but a TMDL is not needed because: (A) the TMDL is approved, (B) other pollution requirements are in place, or (C) the impairment (such as flow or lack of flow) is not caused by a pollutant.

Category 3B: Water quality is of potential concern; some data indicate non-attainment of a criterion, but

Report Generated: April 6, 2022 03:07 AM

data are insufficient to assign another category.

Dominant soil type(s)			
Soil Type	Erosion Hazard Rating	Hydric Rating	Percent Area
Rock outcrop-Xerumbrepts complex, undulating	Not rated	No	100.00%

This report contains both centroid-based and polygon-based data. The Location Information section of the report contains centroid-based data (determined by the center point of the polygon), while the remaining sections are polygon-based (determined from the entire polygon).

The rare species results in this report are based on a subset of the ORBIC rare species dataset. The SFAM tool only reports on rare species that meet the following criteria: wetland habitat species that are tracked by ORBIC, excluding historical or extirpated sites or those with low mapping accuracy. More information about specific sites and additional species can be obtained from ORBIC through data requests, see <https://inr.oregonstate.edu/orbic/data-requests> for details.

Perennial Stream 1-A

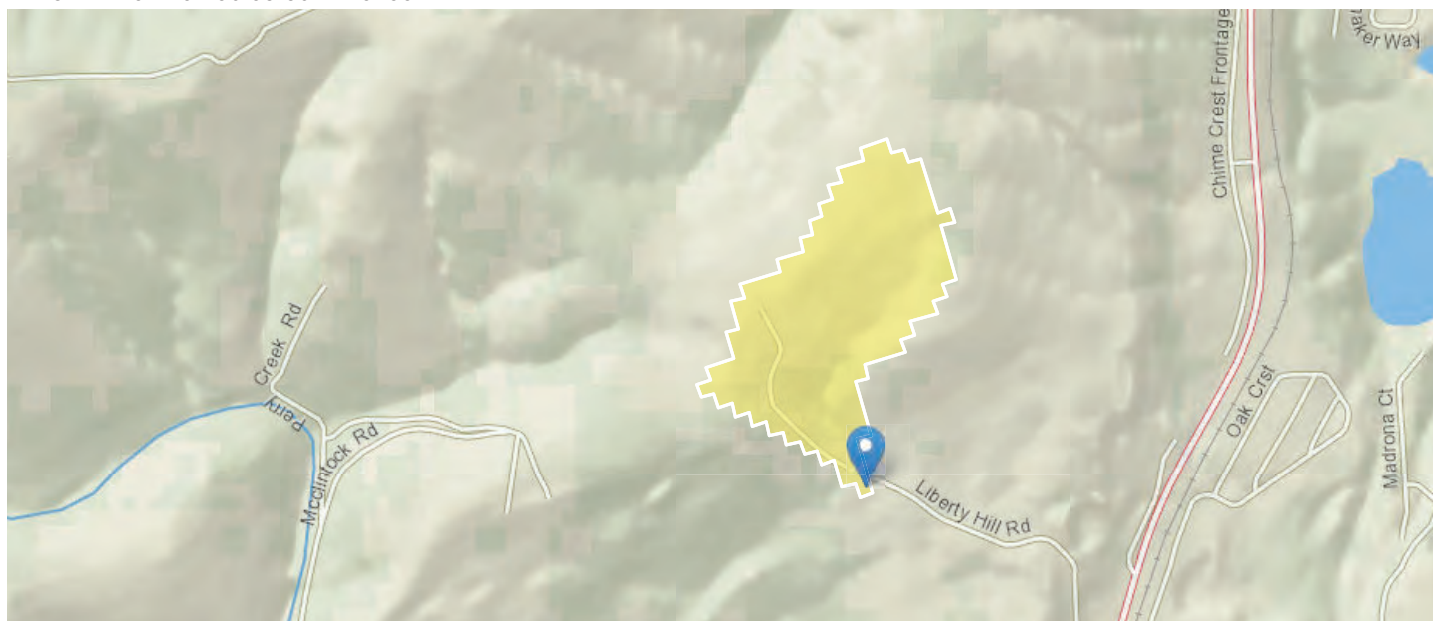
StreamStats Report

Region ID: OR

Workspace ID: OR20220406105550044000

Clicked Point (Latitude, Longitude): 45.87438, -122.82202

Time: 2022-04-06 03:56:12 -0700



Basin Characteristics

Parameter Code	Parameter Description	Value	Unit
----------------	-----------------------	-------	------

Parameter Code	Parameter Description	Value	Unit
ASPECT	basin average of topographic slope compass directions from elevation grid	167	degrees
BSLOPD	Mean basin slope measured in degrees	5.42	degrees
DRNAREA	Area that drains to a point on a stream	0.0782	square miles
DRNDENSITY	Basin drainage density defined as total stream length divided by drainage area.	0	dimensionless
ELEV	Mean Basin Elevation	398	feet
ELEVMAX	Maximum basin elevation	447	feet
FOREST	Percentage of area covered by forest	84	percent
I24H2Y	Maximum 24-hour precipitation that occurs on average once in 2 years - Equivalent to precipitation intensity index	1.77	inches
IMPERV	Percentage of impervious area	4.97	percent
JANAVPRE2K	Mean January Precipitation	6.94	inches
JANMAXT2K	Mean Maximum January Temperature from 2K resolution PRISM 1961-1990 data	45.1	degrees F
JANMAXTMP	Mean Maximum January Temperature	44.7	degrees F
JANMINT2K	Mean Minimum January Temperature from 2K resolution PRISM PRISM 1961-1990 data	32.3	degrees F
JANMINTMP	Mean Minimum January Temperature	32.2	degrees F
JULAVPRE2K	Mean July Average Precipitation	0.65	inches
LC11BARE	Percentage of barren from NLCD 2011 class 31	0	percent
LC11CRPHAY	Percentage of cultivated crops and hay, classes 81 and 82, from NLCD 2011	44	percent
LC11DEVHI	Percentage of area developed, high intensity, NLCD 2011 class 24	0	percent
LC11DVLO	Percentage of developed area, low intensity, from NLCD 2011 class 22	0	percent
LC11DVMD	Percentage of area developed, medium intensity, NLCD 2011 class 23	0	percent

Parameter Code	Parameter Description	Value	Unit
LC11DVOPN	Percentage of developed open area from NLCD 2011 class 21	8	percent
LC11FORSHB	Percentage of forests and shrub lands, classes 41 to 52, from NLCD 2011	48	percent
LC11HERB	Percentage of herbaceous from NLCD 2011 classes 71-74	0	percent
LC11IMP	Average percentage of impervious area determined from NLCD 2011 impervious dataset	0.79	percent
LC11WATER	Percent of open water, class 11, from NLCD 2011	0	percent
LC11WETLND	Percentage of wetlands, classes 90 and 95, from NLCD 2011	0	percent
MAJ_ROADS	Length of non-state major roads in basin	0	miles
MAXBSLOPD	Maximum basin slope, in degrees, using ArcInfo Grid with NHDPlus 30-m resolution elevation data.	14.5	degrees
MAXTEMP	Mean annual maximum air temperature over basin area from PRISM 1971-2000 800-m grid	61.5	degrees F
MIN_ROADS	Length of non-state minor roads in basin	0.28	miles
MINBELEV	Minimum basin elevation	273	feet
MINBSLOPD	Minimum basin slope, in degrees, using ArcInfo Grid with NHDPlus 30-m resolution elevation data.	0.18	degrees
MINTEMP	Mean annual minimum air temperature over basin surface area as defined in SIR 2008-5126	41.5	degrees F
OR_HIPERMA	Percent basin surface area containing high permeability aquifer units as defined in SIR 2008-5126	0	percent
OR_HIPERMG	Percent basin surface area containing high permeability geologic units as defined in SIR 2008-5126	0	percent
ORREG2	Oregon Region Number	10001	dimensionless
PRECIP	Mean Annual Precipitation	49.1	inches

Parameter Code	Parameter Description	Value	Unit
RELIEF	Maximum - minimum elevation	173	feet
SOILPERM	Average Soil Permeability	2.2	inches per hour
STATE_HWY	Length of state highways in basin	0	miles
STATSGODEP	Area-weighted average soil depth from NRCS STATSGO database	45	inches
STRMTOT	total length of all mapped streams (1:24,000-scale) in the basin	0	miles
WATCAPORC	Available water capacity from STATSGO data using methods from SIR 2005-5116	0.11	inches
WATCAPORR	Available water capacity from STATSGO data using methods from SIR 2008-5126	0.11	inch per inch

Peak-Flow Statistics Parameters [Reg 2B Western Interior LT 3000 ft Cooper]

Parameter Code	Parameter Name	Value	Units	Min Limit	Max Limit
DRNAREA	Drainage Area	0.0782	square miles	0.37	7270
BSLOPD	Mean Basin Slope degrees	5.42	degrees	5.62	28.3
I24H2Y	24 Hour 2 Year Precipitation	1.77	inches	1.53	4.48
ELEV	Mean Basin Elevation	398	feet		
ORREG2	Oregon Region Number	10001	dimensionless		

Peak-Flow Statistics Disclaimers [Reg 2B Western Interior LT 3000 ft Cooper]

One or more of the parameters is outside the suggested range. Estimates were extrapolated with unknown errors.

Peak-Flow Statistics Flow Report [Reg 2B Western Interior LT 3000 ft Cooper]

Statistic	Value	Unit
50-percent AEP flood	3.3	ft ³ /s
20-percent AEP flood	4.92	ft ³ /s
10-percent AEP flood	6.02	ft ³ /s
4-percent AEP flood	7.44	ft ³ /s
2-percent AEP flood	8.49	ft ³ /s
1-percent AEP flood	9.55	ft ³ /s
0.2-percent AEP flood	12	ft ³ /s

Peak-Flow Statistics Citations

Cooper, R.M., 2005, Estimation of Peak Discharges for Rural, Unregulated Streams in Western Oregon: U.S. Geological Survey Scientific Investigations Report 2005-5116, 76 p. (<http://pubs.usgs.gov/sir/2005/5116/pdf/sir2005-5116.pdf>)

Low-Flow Statistics Parameters [99.8 Percent (0.0781 square miles) LowFlow Ann Region01 2008 5126]

Parameter Code	Parameter Name	Value	Units	Min Limit	Max Limit
DRNAREA	Drainage Area	0.0782	square miles	0.367	590.347
PRECIP	Mean Annual Precipitation	49.1	inches	65.5923	122.9843
WATCAPORR	Available_Water_Capacity_OR_Risley	0.11	inch per inch	0.12	0.23

Low-Flow Statistics Disclaimers [99.8 Percent (0.0781 square miles) LowFlow Ann Region01 2008 5126]

One or more of the parameters is outside the suggested range. Estimates were extrapolated with unknown errors.

Low-Flow Statistics Flow Report [99.8 Percent (0.0781 square miles) LowFlow Ann Region01 2008 5126]

Statistic	Value	Unit
7 Day 2 Year Low Flow	0.00384	ft ³ /s
7 Day 10 Year Low Flow	0.00184	ft ³ /s

Low-Flow Statistics Citations

Risley, John, Stonewall, Adam, and Haluska, Tana, 2008, Estimating flow-duration and low-flow frequency statistics for unregulated streams in Oregon: U.S. Geological Survey Scientific Investigations Report 2008-5126, 22 p. (<http://pubs.usgs.gov/sir/2008/5126/>)

Flow-Duration Statistics Parameters [99.8 Percent (0.0781 square miles) LowFlow Ann Region01 2008 5126]

Parameter Code	Parameter Name	Value	Units	Min Limit	Max Limit
DRNAREA	Drainage Area	0.0782	square miles	0.367	590.347
PRECIP	Mean Annual Precipitation	49.1	inches	65.5923	122.9843
WATCAPORR	Available_Water_Capacity_OR_Risley	0.11	inch per inch	0.12	0.23

Flow-Duration Statistics Disclaimers [99.8 Percent (0.0781 square miles) LowFlow Ann Region01 2008 5126]

One or more of the parameters is outside the suggested range. Estimates were extrapolated with unknown errors.

Flow-Duration Statistics Flow Report [99.8 Percent (0.0781 square miles) LowFlow Ann Region01 2008 5126]

Statistic	Value	Unit
5 Percent Duration	0.873	ft ³ /s
10 Percent Duration	0.559	ft ³ /s
25 Percent Duration	0.236	ft ³ /s

Statistic	Value	Unit
50 Percent Duration	0.0711	ft ³ /s
95 Percent Duration	0.00413	ft ³ /s

Flow-Duration Statistics Citations

Risley, John, Stonewall, Adam, and Haluska, Tana, 2008, Estimating flow-duration and low-flow frequency statistics for unregulated streams in Oregon: U.S. Geological Survey Scientific Investigations Report 2008-5126, 22 p. (<http://pubs.usgs.gov/sir/2008/5126/>)

Monthly Flow Statistics Parameters [99.8 Percent (0.0781 square miles) LowFlow Apr Region01 2008 5126]

Parameter Code	Parameter Name	Value	Units	Min Limit	Max Limit
DRNAREA	Drainage Area	0.0782	square miles	0.367	673.359
PRECIP	Mean Annual Precipitation	49.1	inches	65.5923	151.2906

Monthly Flow Statistics Parameters [99.8 Percent (0.0781 square miles) LowFlow Aug Region01 2008 5126]

Parameter Code	Parameter Name	Value	Units	Min Limit	Max Limit
DRNAREA	Drainage Area	0.0782	square miles	0.367	673.359
JANMINTMP	Mean Min January Temperature	32.2	degrees F	30.678	34.661
PRECIP	Mean Annual Precipitation	49.1	inches	65.5923	151.2906

Monthly Flow Statistics Parameters [99.8 Percent (0.0781 square miles) LowFlow Dec Region01 2008 5126]

Parameter Code	Parameter Name	Value	Units	Min Limit	Max Limit
DRNAREA	Drainage Area	0.0782	square miles	0.367	673.359

Parameter Code	Parameter Name	Value	Units	Min Limit	Max Limit
PRECIP	Mean Annual Precipitation	49.1	inches	65.5923	151.2906

Monthly Flow Statistics Parameters [99.8 Percent (0.0781 square miles) LowFlow Feb Region01 2008 5126]

Parameter Code	Parameter Name	Value	Units	Min Limit	Max Limit
DRNAREA	Drainage Area	0.0782	square miles	0.367	673.359
PRECIP	Mean Annual Precipitation	49.1	inches	65.5923	151.2906

Monthly Flow Statistics Parameters [99.8 Percent (0.0781 square miles) LowFlow Jan Region01 2008 5126]

Parameter Code	Parameter Name	Value	Units	Min Limit	Max Limit
DRNAREA	Drainage Area	0.0782	square miles	0.367	673.359
PRECIP	Mean Annual Precipitation	49.1	inches	65.5923	151.2906

Monthly Flow Statistics Parameters [99.8 Percent (0.0781 square miles) LowFlow Jul Region01 2008 5126]

Parameter Code	Parameter Name	Value	Units	Min Limit	Max Limit
DRNAREA	Drainage Area	0.0782	square miles	0.367	673.359
JANMINTMP	Mean Min January Temperature	32.2	degrees F	30.678	34.661
PRECIP	Mean Annual Precipitation	49.1	inches	65.5923	151.2906

Monthly Flow Statistics Parameters [99.8 Percent (0.0781 square miles) LowFlow Jun Region01 2008 5126]

Parameter Code	Parameter Name	Value	Units	Min Limit	Max Limit
DRNAREA	Drainage Area	0.0782	square miles	0.367	673.359
PRECIP	Mean Annual Precipitation	49.1	inches	65.5923	151.2906

Monthly Flow Statistics Parameters [99.8 Percent (0.0781 square miles) LowFlow Mar Region01 2008 5126]

Parameter Code	Parameter Name	Value	Units	Min Limit	Max Limit
DRNAREA	Drainage Area	0.0782	square miles	0.367	673.359
PRECIP	Mean Annual Precipitation	49.1	inches	65.5923	151.2906

Monthly Flow Statistics Parameters [99.8 Percent (0.0781 square miles) LowFlow May Region01 2008 5126]

Parameter Code	Parameter Name	Value	Units	Min Limit	Max Limit
DRNAREA	Drainage Area	0.0782	square miles	1.953	673.359
PRECIP	Mean Annual Precipitation	49.1	inches	65.5923	151.2906

Monthly Flow Statistics Parameters [99.8 Percent (0.0781 square miles) LowFlow Nov Region01 2008 5126]

Parameter Code	Parameter Name	Value	Units	Min Limit	Max Limit
DRNAREA	Drainage Area	0.0782	square miles	0.367	673.359
ELEV	Mean Basin Elevation	398	feet	520.406	2101.874
PRECIP	Mean Annual Precipitation	49.1	inches	65.5923	151.2906

Monthly Flow Statistics Parameters [99.8 Percent (0.0781 square miles) LowFlow Oct Region01 2008 5126]

Parameter Code	Parameter Name	Value	Units	Min Limit	Max Limit
DRNAREA	Drainage Area	0.0782	square miles	0.367	219.691
ELEV	Mean Basin Elevation	398	feet	520.406	2101.874
PRECIP	Mean Annual Precipitation	49.1	inches	71.6651	143.4891

Monthly Flow Statistics Parameters [99.8 Percent (0.0781 square miles) LowFlow Sep Region01 2008 5126]

Parameter Code	Parameter Name	Value	Units	Min Limit	Max Limit
DRNAREA	Drainage Area	0.0782	square miles	0.367	590.347
PRECIP	Mean Annual Precipitation	49.1	inches	65.5923	151.2906

Monthly Flow Statistics Disclaimers [99.8 Percent (0.0781 square miles) LowFlow Apr Region01 2008 5126]

One or more of the parameters is outside the suggested range. Estimates were extrapolated with unknown errors.

Monthly Flow Statistics Flow Report [99.8 Percent (0.0781 square miles) LowFlow Apr Region01 2008 5126]

Statistic	Value	Unit
Apr 7 Day 2 Year Low Flow	0.1	ft ³ /s
Apr 7 Day 10 Year Low Flow	0.0559	ft ³ /s

Monthly Flow Statistics Disclaimers [99.8 Percent (0.0781 square miles) LowFlow Aug Region01 2008 5126]

One or more of the parameters is outside the suggested range. Estimates were extrapolated with unknown errors.

Monthly Flow Statistics Flow Report [99.8 Percent (0.0781 square miles) LowFlow Aug Region01 2008 5126]

Statistic	Value	Unit
Aug 7 Day 2 Year Low Flow	0.00336	ft ³ /s
Aug 7 Day 10 Year Low Flow	0.00174	ft ³ /s

Monthly Flow Statistics Disclaimers [99.8 Percent (0.0781 square miles) LowFlow Dec Region01 2008 5126]

One or more of the parameters is outside the suggested range. Estimates were extrapolated with unknown errors.

Monthly Flow Statistics Flow Report [99.8 Percent (0.0781 square miles) LowFlow Dec Region01 2008 5126]

Statistic	Value	Unit
Dec 7 Day 2 Year Low Flow	0.165	ft ³ /s
Dec 7 Day 10 Year Low Flow	0.0462	ft ³ /s

Monthly Flow Statistics Disclaimers [99.8 Percent (0.0781 square miles) LowFlow Feb Region01 2008 5126]

One or more of the parameters is outside the suggested range. Estimates were extrapolated with unknown errors.

Monthly Flow Statistics Flow Report [99.8 Percent (0.0781 square miles) LowFlow Feb Region01 2008 5126]

Statistic	Value	Unit
Feb 7 Day 2 Year Low Flow	0.194	ft ³ /s
Feb 7 Day 10 Year Low Flow	0.0914	ft ³ /s

Monthly Flow Statistics Disclaimers [99.8 Percent (0.0781 square miles) LowFlow Jan Region01 2008 5126]

One or more of the parameters is outside the suggested range. Estimates were extrapolated with unknown errors.

Monthly Flow Statistics Flow Report [99.8 Percent (0.0781 square miles) LowFlow Jan Region01 2008 5126]

Statistic	Value	Unit
Jan 7 Day 2 Year Low Flow	0.238	ft ³ /s
Jan 7 Day 10 Year Low Flow	0.112	ft ³ /s

Monthly Flow Statistics Disclaimers [99.8 Percent (0.0781 square miles) LowFlow Jul Region01 2008 5126]

One or more of the parameters is outside the suggested range. Estimates were extrapolated with unknown errors.

Monthly Flow Statistics Flow Report [99.8 Percent (0.0781 square miles) LowFlow Jul Region01 2008 5126]

Statistic	Value	Unit
Jul 7 Day 2 Year Low Flow	0.00564	ft ³ /s
Jul 7 Day 10 Year Low Flow	0.00362	ft ³ /s

Monthly Flow Statistics Disclaimers [99.8 Percent (0.0781 square miles) LowFlow Jun Region01 2008 5126]

One or more of the parameters is outside the suggested range. Estimates were extrapolated with unknown errors.

Monthly Flow Statistics Flow Report [99.8 Percent (0.0781 square miles) LowFlow Jun Region01 2008 5126]

Statistic	Value	Unit
Jun 7 Day 2 Year Low Flow	0.0294	ft ³ /s
Jun 7 Day 10 Year Low Flow	0.0199	ft ³ /s

Monthly Flow Statistics Disclaimers [99.8 Percent (0.0781 square miles) LowFlow Mar Region01 2008 5126]

One or more of the parameters is outside the suggested range. Estimates were extrapolated with unknown errors.

Monthly Flow Statistics Flow Report [99.8 Percent (0.0781 square miles) LowFlow Mar Region01 2008 5126]

Statistic	Value	Unit
Mar 7 Day 2 Year Low Flow	0.172	ft ³ /s
Mar 7 Day 10 Year Low Flow	0.0955	ft ³ /s

Monthly Flow Statistics Disclaimers [99.8 Percent (0.0781 square miles) LowFlow May Region01 2008 5126]

One or more of the parameters is outside the suggested range. Estimates were extrapolated with unknown errors.

Monthly Flow Statistics Flow Report [99.8 Percent (0.0781 square miles) LowFlow May Region01 2008 5126]

Statistic	Value	Unit
May 7 Day 2 Year Low Flow	0.0776	ft ³ /s
May 7 Day 10 Year Low Flow	0.0575	ft ³ /s

Monthly Flow Statistics Disclaimers [99.8 Percent (0.0781 square miles) LowFlow Nov Region01 2008 5126]

One or more of the parameters is outside the suggested range. Estimates were extrapolated with unknown errors.

Monthly Flow Statistics Flow Report [99.8 Percent (0.0781 square miles) LowFlow Nov Region01 2008 5126]

Statistic	Value	Unit
Nov 7 Day 2 Year Low Flow	0.0397	ft ³ /s
Nov 7 Day 10 Year Low Flow	0.0168	ft ³ /s

Monthly Flow Statistics Disclaimers [99.8 Percent (0.0781 square miles) LowFlow Oct Region01 2008 5126]

One or more of the parameters is outside the suggested range. Estimates were extrapolated with unknown errors.

Monthly Flow Statistics Flow Report [99.8 Percent (0.0781 square miles) LowFlow Oct Region01 2008 5126]

Statistic	Value	Unit
Oct 7 Day 2 Year Low Flow	0.0035	ft ³ /s
Oct 7 Day 10 Year Low Flow	0.00159	ft ³ /s

Monthly Flow Statistics Disclaimers [99.8 Percent (0.0781 square miles) LowFlow Sep Region01 2008 5126]

One or more of the parameters is outside the suggested range. Estimates were extrapolated with unknown errors.

Monthly Flow Statistics Flow Report [99.8 Percent (0.0781 square miles) LowFlow Sep Region01 2008 5126]

Statistic	Value	Unit
Sep 7 Day 2 Year Low Flow	0.00389	ft ³ /s
Sep 7 Day 10 Year Low Flow	0.00154	ft ³ /s

Monthly Flow Statistics Flow Report [Area-Averaged]

Statistic	Value	Unit
Apr 7 Day 2 Year Low Flow	0.0998	ft ³ /s
Apr 7 Day 10 Year Low Flow	0.0558	ft ³ /s
Aug 7 Day 2 Year Low Flow	0.00335	ft ³ /s
Aug 7 Day 10 Year Low Flow	0.00174	ft ³ /s
Dec 7 Day 2 Year Low Flow	0.165	ft ³ /s
Dec 7 Day 10 Year Low Flow	0.0461	ft ³ /s
Feb 7 Day 2 Year Low Flow	0.194	ft ³ /s
Feb 7 Day 10 Year Low Flow	0.0913	ft ³ /s
Jan 7 Day 2 Year Low Flow	0.238	ft ³ /s
Jan 7 Day 10 Year Low Flow	0.112	ft ³ /s
Jul 7 Day 2 Year Low Flow	0.00563	ft ³ /s
Jul 7 Day 10 Year Low Flow	0.00361	ft ³ /s
Jun 7 Day 2 Year Low Flow	0.0294	ft ³ /s

Statistic	Value	Unit
Jun 7 Day 10 Year Low Flow	0.0199	ft ³ /s
Mar 7 Day 2 Year Low Flow	0.172	ft ³ /s
Mar 7 Day 10 Year Low Flow	0.0954	ft ³ /s
May 7 Day 2 Year Low Flow	0.0775	ft ³ /s
May 7 Day 10 Year Low Flow	0.0574	ft ³ /s
Nov 7 Day 2 Year Low Flow	0.0396	ft ³ /s
Nov 7 Day 10 Year Low Flow	0.0168	ft ³ /s
Oct 7 Day 2 Year Low Flow	0.00349	ft ³ /s
Oct 7 Day 10 Year Low Flow	0.00159	ft ³ /s
Sep 7 Day 2 Year Low Flow	0.00388	ft ³ /s
Sep 7 Day 10 Year Low Flow	0.00154	ft ³ /s

Monthly Flow Statistics Citations

Risley, John, Stonewall, Adam, and Haluska, Tana, 2008, Estimating flow-duration and low-flow frequency statistics for unregulated streams in Oregon: U.S. Geological Survey Scientific Investigations Report 2008-5126, 22 p. (<http://pubs.usgs.gov/sir/2008/5126/>)

Bankfull Statistics Parameters [Pacific Mountain System D Bieger 2015]

Parameter Code	Parameter Name	Value	Units	Min Limit	Max Limit
DRNAREA	Drainage Area	0.0782	square miles	6.1776	8079.9147

Bankfull Statistics Parameters [Pacific Border P Bieger 2015]

Parameter Code	Parameter Name	Value	Units	Min Limit	Max Limit
DRNAREA	Drainage Area	0.0782	square miles	6.169878	3938.976756

Bankfull Statistics Parameters [USA Bieger 2015]

Parameter Code	Parameter Name	Value	Units	Min Limit	Max Limit
DRNAREA	Drainage Area	0.0782	square miles	0.07722	59927.7393

Bankfull Statistics Parameters [Pac Maritime Mtn CastroJackson 2001]

Parameter Code	Parameter Name	Value	Units	Min Limit	Max Limit
DRNAREA	Drainage Area	0.0782	square miles	54.8	3093

Bankfull Statistics Disclaimers [Pacific Mountain System D Bieger 2015]

One or more of the parameters is outside the suggested range. Estimates were extrapolated with unknown errors.

Bankfull Statistics Flow Report [Pacific Mountain System D Bieger 2015]

Statistic	Value	Unit
Bieger_D_channel_width	4.79	ft
Bieger_D_channel_depth	0.472	ft
Bieger_D_channel_cross_sectional_area	3.31	ft^2

Bankfull Statistics Disclaimers [Pacific Border P Bieger 2015]

One or more of the parameters is outside the suggested range. Estimates were extrapolated with unknown errors.

Bankfull Statistics Flow Report [Pacific Border P Bieger 2015]

Statistic	Value	Unit
Bieger_P_channel_width	3.58	ft
Bieger_P_channel_cross_sectional_area	2.46	ft ²
Bieger_P_channel_depth	0.407	ft

Bankfull Statistics Flow Report [USA Bieger 2015]

Statistic	Value	Unit
Bieger_USA_channel_width	5.05	ft
Bieger_USA_channel_depth	0.701	ft
Bieger_USA_channel_cross_sectional_area	4.32	ft ²

Bankfull Statistics Disclaimers [Pac Maritime Mtn CastroJackson 2001]

One or more of the parameters is outside the suggested range. Estimates were extrapolated with unknown errors.

Bankfull Statistics Flow Report [Pac Maritime Mtn CastroJackson 2001]

Statistic	Value	Unit
Bankfull Width	4.14	ft
Bankfull Depth	0.244	ft
Bankfull Area	2.17	ft ²
Bankfull Streamflow	16.5	ft ³ /s

Bankfull Statistics Flow Report [Area-Averaged]

Statistic	Value	Unit
-----------	-------	------

Statistic	Value	Unit
Bieger_D_channel_width	4.79	ft
Bieger_D_channel_depth	0.472	ft
Bieger_D_channel_cross_sectional_area	3.31	ft ²
Bieger_P_channel_width	3.58	ft
Bieger_P_channel_cross_sectional_area	2.46	ft ²
Bieger_P_channel_depth	0.407	ft
Bieger_USA_channel_width	5.05	ft
Bieger_USA_channel_depth	0.701	ft
Bieger_USA_channel_cross_sectional_area	4.32	ft ²
Bankfull Width	4.14	ft
Bankfull Depth	0.244	ft
Bankfull Area	2.17	ft ²
Bankfull Streamflow	16.5	ft ³ /s

Bankfull Statistics Citations

Bieger, Katrin; Rathjens, Hendrik; Allen, Peter M.; and Arnold, Jeffrey G., 2015, Development and Evaluation of Bankfull Hydraulic Geometry Relationships for the Physiographic Regions of the United States, Publications from USDA-ARS / UNL Faculty, 17p. (https://digitalcommons.unl.edu/usdaarsfacpub/1515?utm_source=digitalcommons.unl.edu%2Fusdaarsfacpub%2F1515&utm_medium=PDF&utm_campaign=PDFCoverPages)

Castro, J.M, and Jackson, P.L. Castro, J.M, and Jackson, P.L., 2001, Bankfull Discharge Recurrence Intervals and Regional Hydraulic Geometry Relationships: Patterns in the Pacific Northwest, USA, Journal of the American Water Resources Association, Volume 37, No. 5, 14 p. (<https://onlinelibrary.wiley.com/doi/abs/10.1111/j.1752-1688.2001.tb03636.x>)

4/6/22, 3:58 AM

StreamStats

USGS Data Disclaimer: Unless otherwise stated, all data, metadata and related materials are considered to satisfy the quality standards relative to the purpose for which the data were collected. Although these data and associated metadata have been reviewed for accuracy and completeness and approved for release by the U.S. Geological Survey (USGS), no warranty expressed or implied is made regarding the display or utility of the data for other purposes, nor on all computer systems, nor shall the act of distribution constitute any such warranty.

USGS Software Disclaimer: This software has been approved for release by the U.S. Geological Survey (USGS). Although the software has been subjected to rigorous review, the USGS reserves the right to update the software as needed pursuant to further analysis and review. No warranty, expressed or implied, is made by the USGS or the U.S. Government as to the functionality of the software and related material nor shall the fact of release constitute any such warranty. Furthermore, the software is released on condition that neither the USGS nor the U.S. Government shall be held liable for any damages resulting from its authorized or unauthorized use.

USGS Product Names Disclaimer: Any use of trade, firm, or product names is for descriptive purposes only and does not imply endorsement by the U.S. Government.

Application Version: 4.8.1

StreamStats Services Version: 1.2.22

NSS Services Version: 2.1.2

Appendix F

Post-Project Stream Functions and Values Assessment Forms

STREAM FUNCTION ASSESSMENT METHOD for OREGON

Version 1.0 (June 2018)

Name of Project Area: Perennial Stream MS-1	Date of Field Assessment:	Latitude*: 45.8693 N
Data Collector: Julie Fox	Elevation: 246 ft <small>(SFAM Report)</small>	Longitude*: -122.8237 W <small>* near center of the project site</small>
Project Number:	Project Area Length (feet): 5222	Project Area (acres): 1.10
Photo Numbers:		

What is the Oregon Stream Classification for the project area? Select from drop-down menu. Refer to the SFAM Report. If the project area spans more than one reach, describe the dominant stream classification. Not Classified

What ratings does the Oregon Stream Classification identify for the following measures in the local hydrologic unit? Refer to the SFAM Report. If project area spans more than one reach, describe the dominant classification:

Aquifer Permeability (local)	Low	Soil Permeability (local)	Low	
Erodibility (local)	Difficult to Erode	Gradient*	2-6%	*If EPA Classification is different from the gradient you observe in the local reach, select the gradient in the local reach.

Is the channel perennial, intermittent, or ephemeral? (Map Viewer-NHD Flowline)	Perennial	
Which Level III EPA Ecoregion is the site located in? (SFAM Report)	Willamette Valley	Western Mountains
Is the average width of the stream less than or greater than 50 feet? (User Input)	≤ 50 feet	Small
What is the 2 year peak flow (cfs)? (StreamStats Report)	6.54	
What is the size of the drainage area (mi ²)? (StreamStats Report)	0.18	

External Data: List below the persons and/or agencies that provided location information on rare wildlife species, and/or rare plants, and the date the information was gathered (if known).
Oregon Biodiversity Information Center (ORBIC) Report, Institute for Natural Resources, Portland State University, 11/22/2019.

Project Area History: Based on conversation with landowner/manager and other information, describe below the years and extent (% of project area) of past and present management actions (e.g., vegetation control), natural disturbances (e.g., fire, insect infestations), and human-associated disturbances (e.g., grazing regimes).

Assessment Notes: Note any special features of the reach or landscape, problems with scoring, or other information that may be relevant.

Predicted conditions of created stream channel under post-project conditions. The following design elements were considered in the SFAM:

1. All surface flow from existing Perennial Stream 1-A would be captured and directed into created stream channel for Perennial Stream MS-1.
2. Sufficient topsoil would be placed in the riparian area along Perennial Stream MS-1 to ensure adequate soil depth to support woody species.
3. Placement of at least 25 pieces of unanchored wood (each a minimum of 4 inches in diameter and 5 feet long) across the Perennial Stream MS-1 channel in various locations to encourage habitat forming processes.
4. Creation of side channels along the Perennial Stream MS-1 channel that make up at least 25% of the length of the created channel.

STREAM ASSESSMENT SCORES SHEET

version 1.0

Project Area Name:	Perennial Stream MS-1		
Investigator Name:	Julie Fox		
Date of Field Assessment:			
Latitude (decimal degrees):	45.8693 N	Longitude (decimal degrees):	-122.8237 W

SPECIFIC FUNCTIONS	Function Score	Function Rating	Value Score	Value Rating
Surface Water Storage (SWS)	7.73	Higher	5.83	Moderate
Sub/Surface Water Transfer (SST)	7.61	Higher	10.00	Higher
Flow Variation (FV)	7.51	Higher	8.33	Higher
Sediment Continuity (SC)	9.85	Higher	3.25	Moderate
Sediment Mobility (SM)	7.40	Higher	7.50	Higher
Maintain Biodiversity (MB)	3.71	Moderate	5.58	Moderate
Create and Maintain Habitat (CMH)	4.21	Moderate	8.33	Higher
Sustain Trophic Structure (STS)	7.96	Higher	6.32	Moderate
Nutrient Cycling (NC)	7.97	Higher	2.50	Lower
Chemical Regulation (CR)	8.80	Higher	2.50	Lower
Thermal Regulation (TR)	4.66	Moderate	9.67	Higher

GROUPED FUNCTIONS	REPRESENTATIVE FUNCTION	Function Group Rating	Value Group Rating
Hydrologic Function (SWS, SST, FV)	Sub/Surface Water Transfer (SST)	Higher	Higher
Geomorphic Function (SC, SM)	Sediment Continuity (SC)	Higher	Moderate
Biologic Function (MB, CMH, STS)	Sustain Trophic Structure (STS)	Higher	Moderate
Water Quality Function (NC, CR, TR)	Chemical Regulation (CR)	Higher	Lower

Formulas for each specific function and value (shown on Subscores tab) produce a numerical score between 0.0 and 10.0. For ecological functions, a score of 0.0 indicates that negligible function is being provided by the stream whereas a score of 10.0 indicates that the stream is providing maximum function (as defined) given certain contextual factors. For values, a score of 0.0 indicates that there is low opportunity for the site to provide a specific ecological function and that, even if it did, the specific function would not be of particular significance given the context of the site. Conversely, a value score or 10.0 indicates that a site has the opportunity to provide a specific function and that it would be highly significant in that particular location. For all function and value formulas, both extents of the scoring range (0.0 and 10.0) are mathematically possible.

To facilitate conceptual understanding, numerical scores are translated into ratings of Lower, Moderate, or Higher. The numerical thresholds for each of these rating categories are consistent across all functions and values such that scores of <3.0 are rated "Lower," scores ≥3.0 but ≤7.0 are rated "Moderate," and scores that are >7.0 are rated "Higher." These thresholds are consistent with the standard scoring scheme applied to all individual measures.

Each specific function, and its associated value, is included in one of four thematic groups: hydrologic, geomorphic, biologic, and water quality functions. Group ratings provide an indication of the degree to which each group of processes is present at a site. Groups are represented by the highest-rated function with the highest-rated associated value among the 2-3 functions that comprise each group. This hierarchical selection system ensures that thematic functional groups are represented by the highest-performing and highest-valued ecological function.

Appendix G

Post-Project SFAM Reports

Created Stream MS-1



Stream Function Assessment Method (SFAM)
Report



Report Generated: April 16, 2022 11:27 AM

Location Information

Latitude	45.8693 N	Longitude	-122.8237 W
Elevation	246 ft	Level III Ecoregion	Willamette Valley
HUC8	17080003 Lower Columbia-Clatskanie		
HUC10	1708000304 Beaver Creek-Frontal Columbia River		
HUC12	170800030401 Deer Island Slough-Frontal Columbia River		
Linear ft of stream in HUC8	216,535	Annual precipitation	44 in

Stream Type and Classifications

No results

Stream classifications and associated attributes are derived from a U.S. Environmental Protection Agency stream classification geospatial data layer developed for Oregon (2015). This layer provides a statewide stream/watershed classification system for streams and rivers of various sizes, based in part on a hydrologic landscape classification system.

Report Generated: April 16, 2022 11:27 AM

Rare Species Scores and Special Habitat Designations

Rare Species Type	Maximum score	Sum Score	Rating
Non-anadromous Fish Species	0	0	None
Amphibian & Reptile Species	0	0	None
Feeding Waterbirds	0	0	None
Songbirds, Raptors, and Mammals	0	0	None
Invertebrate Species	0	0	None
Plant Species	0	0	None

Scores have taken into account several factors for each rare species record contained in the official database of the Oregon Biodiversity Information Center (ORBIC): (a) the regional rarity of the species, (b) their proximity to the point of interest, and (c) the “certainty” that ORBIC assigns to each of those records.

Within 300 ft of a Special Protected Area?	No
Within a HUC12 that has designated Essential Salmonid Habitat?	Yes
Within 2 miles of an Important Bird Area?	No

Water Quality Impairments

Water quality information is derived from Oregon’s 2012 Integrated Report, including the list of water quality limited waters needing Total Maximum Daily Loads (303d List). Each record in the report is assigned an assessment category based on an evaluation of water quality information. Categories included in the SFAM Report are:

Category 5: Water is water quality limited and a TMDL is needed; Section 303(d) list.

Category 4: Water is impaired or threatened but a TMDL is not needed because: (A) the TMDL is approved, (B) other pollution requirements are in place, or (C) the impairment (such as flow or lack of flow) is not caused by a pollutant.

Category 3B: Water quality is of potential concern; some data indicate non-attainment of a criterion, but

Report Generated: April 16, 2022 11:27 AM

data are insufficient to assign another category.

Dominant soil type(s)			
Soil Type	Erosion Hazard Rating	Hydric Rating	Percent Area
Rock outcrop-Xerumbrepts complex, undulating	Not rated	No	100.00%

This report contains both centroid-based and polygon-based data. The Location Information section of the report contains centroid-based data (determined by the center point of the polygon), while the remaining sections are polygon-based (determined from the entire polygon).

The rare species results in this report are based on a subset of the ORBIC rare species dataset. The SFAM tool only reports on rare species that meet the following criteria: wetland habitat species that are tracked by ORBIC, excluding historical or extirpated sites or those with low mapping accuracy. More information about specific sites and additional species can be obtained from ORBIC through data requests, see <https://inr.oregonstate.edu/orbic/data-requests> for details.

Created Stream MS-1

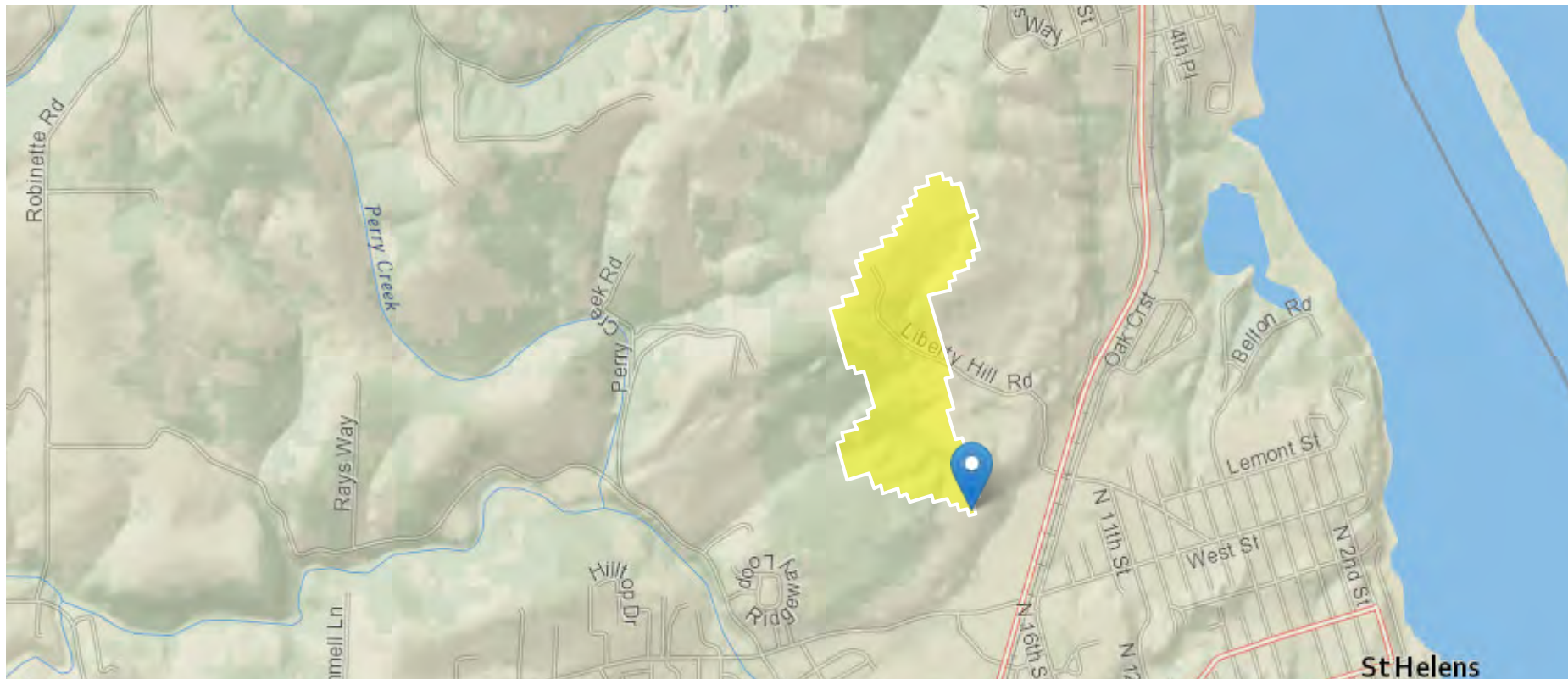
StreamStats Report

Region ID: OR

Workspace ID: OR20220416182843030000

Clicked Point (Latitude, Longitude): 45.86932, -122.81981

Time: 2022-04-16 11:29:14 -0700



Basin Characteristics

Parameter

Code

Parameter Description

Value Unit

Parameter Code	Parameter Description	Value	Unit
ASPECT	basin average of topographic slope compass directions from elevation grid	161	degrees
BSLOPD	Mean basin slope measured in degrees	4.69	degrees
DRNAREA	Area that drains to a point on a stream	0.18	square miles
DRNDENSITY	Basin drainage density defined as total stream length divided by drainage area.	0	dimensionless
ELEV	Mean Basin Elevation	327	feet
ELEVMAX	Maximum basin elevation	447	feet
FOREST	Percentage of area covered by forest	75.4	percent
I24H2Y	Maximum 24-hour precipitation that occurs on average once in 2 years - Equivalent to precipitation intensity index	1.77	inches
IMPERV	Percentage of impervious area	8.02	percent
JANAVPRE2K	Mean January Precipitation	6.96	inches
JANMAXT2K	Mean Maximum January Temperature from 2K resolution PRISM 1961-1990 data	45.1	degrees F
JANMAXTMP	Mean Maximum January Temperature	44.7	degrees F
JANMINT2K	Mean Minimum January Temperature from 2K resolution PRISM PRISM 1961-1990 data	32.3	degrees F
JANMINTMP	Mean Minimum January Temperature	32.3	degrees F
JULAVPRE2K	Mean July Average Precipitation	0.64	inches
ORREG2	Oregon Region Number	10001	dimensionless
PRECIP	Mean Annual Precipitation	48.6	inches
RELIEF	Maximum - minimum elevation	243	feet
SOILPERM	Average Soil Permeability	2.2	inches per hour
WATCAPORC	Available water capacity from STATSGO data using methods from SIR 2005-5116	0.11	inches

Parameter Code	Parameter Description	Value	Unit
WATCAPORR	Available water capacity from STATSGO data using methods from SIR 2008-5126	0.11	inch per inch

Peak-Flow Statistics Parameters [Reg 2B Western Interior LT 3000 ft Cooper]

Parameter Code	Parameter Name	Value	Units	Min Limit	Max Limit
DRNAREA	Drainage Area	0.18	square miles	0.37	7270
BSLOPD	Mean Basin Slope degrees	4.69	degrees	5.62	28.3
I24H2Y	24 Hour 2 Year Precipitation	1.77	inches	1.53	4.48
ELEV	Mean Basin Elevation	327	feet		
ORREG2	Oregon Region Number	10001	dimensionless		

Peak-Flow Statistics Disclaimers [Reg 2B Western Interior LT 3000 ft Cooper]

One or more of the parameters is outside the suggested range. Estimates were extrapolated with unknown errors.

Peak-Flow Statistics Flow Report [Reg 2B Western Interior LT 3000 ft Cooper]

Statistic	Value	Unit
50-percent AEP flood	6.54	ft ³ /s
20-percent AEP flood	9.76	ft ³ /s
10-percent AEP flood	12	ft ³ /s
4-percent AEP flood	14.8	ft ³ /s
2-percent AEP flood	17	ft ³ /s

Statistic	Value	Unit
1-percent AEP flood	19.1	ft ³ /s
0.2-percent AEP flood	24.1	ft ³ /s

Peak-Flow Statistics Citations

Cooper, R.M.,2005, Estimation of Peak Discharges for Rural, Unregulated Streams in Western Oregon: U.S. Geological Survey Scientific Investigations Report 2005-5116, 76 p. (<http://pubs.usgs.gov/sir/2005/5116/pdf/sir2005-5116.pdf>)

Low-Flow Statistics Parameters [99.8 Percent (0.178 square miles) LowFlow Ann Region01 2008 5126]

Parameter Code	Parameter Name	Value	Units	Min Limit	Max Limit
DRNAREA	Drainage Area	0.18	square miles	0.367	590.347
PRECIP	Mean Annual Precipitation	48.6	inches	65.5923	122.9843
WATCAPORR	Available_Water_Capacity_OR_Risley	0.11	inch per inch	0.12	0.23

Low-Flow Statistics Disclaimers [99.8 Percent (0.178 square miles) LowFlow Ann Region01 2008 5126]

One or more of the parameters is outside the suggested range. Estimates were extrapolated with unknown errors.

Low-Flow Statistics Flow Report [99.8 Percent (0.178 square miles) LowFlow Ann Region01 2008 5126]

Statistic	Value	Unit
7 Day 2 Year Low Flow	0.00904	ft ³ /s
7 Day 10 Year Low Flow	0.00449	ft ³ /s

Low-Flow Statistics Citations

Risley, John, Stonewall, Adam, and Haluska, Tana,2008, Estimating flow-duration and low-flow frequency statistics for unregulated streams in Oregon: U.S. Geological Survey Scientific Investigations Report 2008-5126, 22 p.
(<http://pubs.usgs.gov/sir/2008/5126/>)

Flow-Duration Statistics Parameters [99.8 Percent (0.178 square miles) LowFlow Ann Region01 2008 5126]

Parameter Code	Parameter Name	Value	Units	Min Limit	Max Limit
DRNAREA	Drainage Area	0.18	square miles	0.367	590.347
PRECIP	Mean Annual Precipitation	48.6	inches	65.5923	122.9843
WATCAPORR	Available_Water_Capacity_OR_Risley	0.11	inch per inch	0.12	0.23

Flow-Duration Statistics Disclaimers [99.8 Percent (0.178 square miles) LowFlow Ann Region01 2008 5126]

One or more of the parameters is outside the suggested range. Estimates were extrapolated with unknown errors.

Flow-Duration Statistics Flow Report [99.8 Percent (0.178 square miles) LowFlow Ann Region01 2008 5126]

Statistic	Value	Unit
5 Percent Duration	2	ft ³ /s
10 Percent Duration	1.29	ft ³ /s
25 Percent Duration	0.543	ft ³ /s
50 Percent Duration	0.163	ft ³ /s
95 Percent Duration	0.0098	ft ³ /s

Flow-Duration Statistics Citations

Risley, John, Stonewall, Adam, and Haluska, Tana,2008, Estimating flow-duration and low-flow frequency statistics for unregulated streams in Oregon: U.S. Geological Survey Scientific Investigations Report 2008-5126, 22 p.

(<http://pubs.usgs.gov/sir/2008/5126/>)

Monthly Flow Statistics Parameters [99.8 Percent (0.178 square miles) LowFlow Apr Region01 2008 5126]

Parameter Code	Parameter Name	Value	Units	Min Limit	Max Limit
DRNAREA	Drainage Area	0.18	square miles	0.367	673.359
PRECIP	Mean Annual Precipitation	48.6	inches	65.5923	151.2906

Monthly Flow Statistics Parameters [99.8 Percent (0.178 square miles) LowFlow Aug Region01 2008 5126]

Parameter Code	Parameter Name	Value	Units	Min Limit	Max Limit
DRNAREA	Drainage Area	0.18	square miles	0.367	673.359
JANMINTMP	Mean Min January Temperature	32.3	degrees F	30.678	34.661
PRECIP	Mean Annual Precipitation	48.6	inches	65.5923	151.2906

Monthly Flow Statistics Parameters [99.8 Percent (0.178 square miles) LowFlow Dec Region01 2008 5126]

Parameter Code	Parameter Name	Value	Units	Min Limit	Max Limit
DRNAREA	Drainage Area	0.18	square miles	0.367	673.359
PRECIP	Mean Annual Precipitation	48.6	inches	65.5923	151.2906

Monthly Flow Statistics Parameters [99.8 Percent (0.178 square miles) LowFlow Feb Region01 2008 5126]

Parameter Code	Parameter Name	Value	Units	Min Limit	Max Limit
DRNAREA	Drainage Area	0.18	square miles	0.367	673.359
PRECIP	Mean Annual Precipitation	48.6	inches	65.5923	151.2906

Monthly Flow Statistics Parameters [99.8 Percent (0.178 square miles) LowFlow Jan Region01 2008 5126]

Parameter Code	Parameter Name	Value	Units	Min Limit	Max Limit
DRNAREA	Drainage Area	0.18	square miles	0.367	673.359
PRECIP	Mean Annual Precipitation	48.6	inches	65.5923	151.2906

Monthly Flow Statistics Parameters [99.8 Percent (0.178 square miles) LowFlow Jul Region01 2008 5126]

Parameter Code	Parameter Name	Value	Units	Min Limit	Max Limit
DRNAREA	Drainage Area	0.18	square miles	0.367	673.359
JANMINTMP	Mean Min January Temperature	32.3	degrees F	30.678	34.661
PRECIP	Mean Annual Precipitation	48.6	inches	65.5923	151.2906

Monthly Flow Statistics Parameters [99.8 Percent (0.178 square miles) LowFlow Jun Region01 2008 5126]

Parameter Code	Parameter Name	Value	Units	Min Limit	Max Limit
DRNAREA	Drainage Area	0.18	square miles	0.367	673.359
PRECIP	Mean Annual Precipitation	48.6	inches	65.5923	151.2906

Monthly Flow Statistics Parameters [99.8 Percent (0.178 square miles) LowFlow Mar Region01 2008 5126]

Parameter Code	Parameter Name	Value	Units	Min Limit	Max Limit
DRNAREA	Drainage Area	0.18	square miles	0.367	673.359
PRECIP	Mean Annual Precipitation	48.6	inches	65.5923	151.2906

Monthly Flow Statistics Parameters [99.8 Percent (0.178 square miles) LowFlow May Region01 2008 5126]

Parameter Code	Parameter Name	Value	Units	Min Limit	Max Limit
----------------	----------------	-------	-------	-----------	-----------

Parameter Code	Parameter Name	Value	Units	Min Limit	Max Limit
DRNAREA	Drainage Area	0.18	square miles	1.953	673.359
PRECIP	Mean Annual Precipitation	48.6	inches	65.5923	151.2906

Monthly Flow Statistics Parameters [99.8 Percent (0.178 square miles) LowFlow Nov Region01 2008 5126]

Parameter Code	Parameter Name	Value	Units	Min Limit	Max Limit
DRNAREA	Drainage Area	0.18	square miles	0.367	673.359
ELEV	Mean Basin Elevation	327	feet	520.406	2101.874
PRECIP	Mean Annual Precipitation	48.6	inches	65.5923	151.2906

Monthly Flow Statistics Parameters [99.8 Percent (0.178 square miles) LowFlow Oct Region01 2008 5126]

Parameter Code	Parameter Name	Value	Units	Min Limit	Max Limit
DRNAREA	Drainage Area	0.18	square miles	0.367	219.691
ELEV	Mean Basin Elevation	327	feet	520.406	2101.874
PRECIP	Mean Annual Precipitation	48.6	inches	71.6651	143.4891

Monthly Flow Statistics Parameters [99.8 Percent (0.178 square miles) LowFlow Sep Region01 2008 5126]

Parameter Code	Parameter Name	Value	Units	Min Limit	Max Limit
DRNAREA	Drainage Area	0.18	square miles	0.367	590.347
PRECIP	Mean Annual Precipitation	48.6	inches	65.5923	151.2906

Monthly Flow Statistics Disclaimers [99.8 Percent (0.178 square miles) LowFlow Apr Region01 2008 5126]

One or more of the parameters is outside the suggested range. Estimates were extrapolated with unknown errors.

Monthly Flow Statistics Flow Report [99.8 Percent (0.178 square miles) LowFlow Apr Region01 2008 5126]

Statistic	Value	Unit
Apr 7 Day 2 Year Low Flow	0.23	ft ³ /s
Apr 7 Day 10 Year Low Flow	0.129	ft ³ /s

Monthly Flow Statistics Disclaimers [99.8 Percent (0.178 square miles) LowFlow Aug Region01 2008 5126]

One or more of the parameters is outside the suggested range. Estimates were extrapolated with unknown errors.

Monthly Flow Statistics Flow Report [99.8 Percent (0.178 square miles) LowFlow Aug Region01 2008 5126]

Statistic	Value	Unit
Aug 7 Day 2 Year Low Flow	0.00808	ft ³ /s
Aug 7 Day 10 Year Low Flow	0.00435	ft ³ /s

Monthly Flow Statistics Disclaimers [99.8 Percent (0.178 square miles) LowFlow Dec Region01 2008 5126]

One or more of the parameters is outside the suggested range. Estimates were extrapolated with unknown errors.

Monthly Flow Statistics Flow Report [99.8 Percent (0.178 square miles) LowFlow Dec Region01 2008 5126]

Statistic	Value	Unit
Dec 7 Day 2 Year Low Flow	0.376	ft ³ /s
Dec 7 Day 10 Year Low Flow	0.104	ft ³ /s

Monthly Flow Statistics Disclaimers [99.8 Percent (0.178 square miles) LowFlow Feb Region01 2008 5126]

One or more of the parameters is outside the suggested range. Estimates were extrapolated with unknown errors.

Monthly Flow Statistics Flow Report [99.8 Percent (0.178 square miles) LowFlow Feb Region01 2008 5126]

Statistic	Value	Unit
Feb 7 Day 2 Year Low Flow	0.452	ft ³ /s
Feb 7 Day 10 Year Low Flow	0.211	ft ³ /s

Monthly Flow Statistics Disclaimers [99.8 Percent (0.178 square miles) LowFlow Jan Region01 2008 5126]

One or more of the parameters is outside the suggested range. Estimates were extrapolated with unknown errors.

Monthly Flow Statistics Flow Report [99.8 Percent (0.178 square miles) LowFlow Jan Region01 2008 5126]

Statistic	Value	Unit
Jan 7 Day 2 Year Low Flow	0.544	ft ³ /s
Jan 7 Day 10 Year Low Flow	0.252	ft ³ /s

Monthly Flow Statistics Disclaimers [99.8 Percent (0.178 square miles) LowFlow Jul Region01 2008 5126]

One or more of the parameters is outside the suggested range. Estimates were extrapolated with unknown errors.

Monthly Flow Statistics Flow Report [99.8 Percent (0.178 square miles) LowFlow Jul Region01 2008 5126]

Statistic	Value	Unit
Jul 7 Day 2 Year Low Flow	0.0134	ft ³ /s
Jul 7 Day 10 Year Low Flow	0.00879	ft ³ /s

Monthly Flow Statistics Disclaimers [99.8 Percent (0.178 square miles) LowFlow Jun Region01 2008 5126]

One or more of the parameters is outside the suggested range. Estimates were extrapolated with unknown errors.

Monthly Flow Statistics Flow Report [99.8 Percent (0.178 square miles) LowFlow Jun Region01 2008 5126]

Statistic	Value	Unit
Jun 7 Day 2 Year Low Flow	0.0664	ft ³ /s
Jun 7 Day 10 Year Low Flow	0.0452	ft ³ /s

Monthly Flow Statistics Disclaimers [99.8 Percent (0.178 square miles) LowFlow Mar Region01 2008 5126]

One or more of the parameters is outside the suggested range. Estimates were extrapolated with unknown errors.

Monthly Flow Statistics Flow Report [99.8 Percent (0.178 square miles) LowFlow Mar Region01 2008 5126]

Statistic	Value	Unit
Mar 7 Day 2 Year Low Flow	0.394	ft ³ /s
Mar 7 Day 10 Year Low Flow	0.219	ft ³ /s

Monthly Flow Statistics Disclaimers [99.8 Percent (0.178 square miles) LowFlow May Region01 2008 5126]

One or more of the parameters is outside the suggested range. Estimates were extrapolated with unknown errors.

Monthly Flow Statistics Flow Report [99.8 Percent (0.178 square miles) LowFlow May Region01 2008 5126]

Statistic	Value	Unit
May 7 Day 2 Year Low Flow	0.174	ft ³ /s
May 7 Day 10 Year Low Flow	0.128	ft ³ /s

Monthly Flow Statistics Disclaimers [99.8 Percent (0.178 square miles) LowFlow Nov Region01 2008 5126]

One or more of the parameters is outside the suggested range. Estimates were extrapolated with unknown errors.

Monthly Flow Statistics Flow Report [99.8 Percent (0.178 square miles) LowFlow Nov Region01 2008 5126]

Statistic	Value	Unit
Nov 7 Day 2 Year Low Flow	0.0975	ft ³ /s
Nov 7 Day 10 Year Low Flow	0.0399	ft ³ /s

Monthly Flow Statistics Disclaimers [99.8 Percent (0.178 square miles) LowFlow Oct Region01 2008 5126]

One or more of the parameters is outside the suggested range. Estimates were extrapolated with unknown errors.

Monthly Flow Statistics Flow Report [99.8 Percent (0.178 square miles) LowFlow Oct Region01 2008 5126]

Statistic	Value	Unit
Oct 7 Day 2 Year Low Flow	0.00963	ft ³ /s
Oct 7 Day 10 Year Low Flow	0.00436	ft ³ /s

Monthly Flow Statistics Disclaimers [99.8 Percent (0.178 square miles) LowFlow Sep Region01 2008 5126]

One or more of the parameters is outside the suggested range. Estimates were extrapolated with unknown errors.

Monthly Flow Statistics Flow Report [99.8 Percent (0.178 square miles) LowFlow Sep Region01 2008 5126]

Statistic	Value	Unit
Sep 7 Day 2 Year Low Flow	0.00928	ft ³ /s
Sep 7 Day 10 Year Low Flow	0.00391	ft ³ /s

Monthly Flow Statistics Flow Report [Area-Averaged]

Statistic	Value	Unit
Apr 7 Day 2 Year Low Flow	0.229	ft ³ /s
Apr 7 Day 10 Year Low Flow	0.129	ft ³ /s
Aug 7 Day 2 Year Low Flow	0.00806	ft ³ /s
Aug 7 Day 10 Year Low Flow	0.00434	ft ³ /s
Dec 7 Day 2 Year Low Flow	0.375	ft ³ /s
Dec 7 Day 10 Year Low Flow	0.104	ft ³ /s
Feb 7 Day 2 Year Low Flow	0.451	ft ³ /s
Feb 7 Day 10 Year Low Flow	0.21	ft ³ /s
Jan 7 Day 2 Year Low Flow	0.543	ft ³ /s
Jan 7 Day 10 Year Low Flow	0.251	ft ³ /s
Jul 7 Day 2 Year Low Flow	0.0134	ft ³ /s
Jul 7 Day 10 Year Low Flow	0.00877	ft ³ /s
Jun 7 Day 2 Year Low Flow	0.0662	ft ³ /s
Jun 7 Day 10 Year Low Flow	0.0451	ft ³ /s
Mar 7 Day 2 Year Low Flow	0.393	ft ³ /s
Mar 7 Day 10 Year Low Flow	0.218	ft ³ /s
May 7 Day 2 Year Low Flow	0.174	ft ³ /s
May 7 Day 10 Year Low Flow	0.128	ft ³ /s
Nov 7 Day 2 Year Low Flow	0.0973	ft ³ /s
Nov 7 Day 10 Year Low Flow	0.0398	ft ³ /s
Oct 7 Day 2 Year Low Flow	0.00961	ft ³ /s

Statistic	Value	Unit
Oct 7 Day 10 Year Low Flow	0.00435	ft ³ /s
Sep 7 Day 2 Year Low Flow	0.00926	ft ³ /s
Sep 7 Day 10 Year Low Flow	0.0039	ft ³ /s

Monthly Flow Statistics Citations

Risley, John, Stonewall, Adam, and Haluska, Tana, 2008, Estimating flow-duration and low-flow frequency statistics for unregulated streams in Oregon: U.S. Geological Survey Scientific Investigations Report 2008-5126, 22 p. (<http://pubs.usgs.gov/sir/2008/5126/>)

Bankfull Statistics Parameters [Pacific Mountain System D Bieger 2015]

Parameter Code	Parameter Name	Value	Units	Min Limit	Max Limit
DRNAREA	Drainage Area	0.18	square miles	6.1776	8079.9147

Bankfull Statistics Parameters [Pacific Border P Bieger 2015]

Parameter Code	Parameter Name	Value	Units	Min Limit	Max Limit
DRNAREA	Drainage Area	0.18	square miles	6.169878	3938.976756

Bankfull Statistics Parameters [USA Bieger 2015]

Parameter Code	Parameter Name	Value	Units	Min Limit	Max Limit
DRNAREA	Drainage Area	0.18	square miles	0.07722	59927.7393

Bankfull Statistics Parameters [Pac Maritime Mtn CastroJackson 2001]

Parameter Code	Parameter Name	Value	Units	Min Limit	Max Limit
DRNAREA	Drainage Area	0.18	square miles	54.8	3093

Bankfull Statistics Disclaimers [Pacific Mountain System D Bieger 2015]

One or more of the parameters is outside the suggested range. Estimates were extrapolated with unknown errors.

Bankfull Statistics Flow Report [Pacific Mountain System D Bieger 2015]

Statistic	Value	Unit
Bieger_D_channel_width	6.68	ft
Bieger_D_channel_depth	0.603	ft
Bieger_D_channel_cross_sectional_area	5.69	ft ²

Bankfull Statistics Disclaimers [Pacific Border P Bieger 2015]

One or more of the parameters is outside the suggested range. Estimates were extrapolated with unknown errors.

Bankfull Statistics Flow Report [Pacific Border P Bieger 2015]

Statistic	Value	Unit
Bieger_P_channel_width	5.16	ft
Bieger_P_channel_cross_sectional_area	4.44	ft ²
Bieger_P_channel_depth	0.536	ft

Bankfull Statistics Flow Report [USA Bieger 2015]

Statistic	Value	Unit
-----------	-------	------

Statistic	Value	Unit
Bieger_USA_channel_width	6.77	ft
Bieger_USA_channel_depth	0.837	ft
Bieger_USA_channel_cross_sectional_area	6.77	ft ²

Bankfull Statistics Disclaimers [Pac Maritime Mtn CastroJackson 2001]

One or more of the parameters is outside the suggested range. Estimates were extrapolated with unknown errors.

Bankfull Statistics Flow Report [Pac Maritime Mtn CastroJackson 2001]

Statistic	Value	Unit
Bankfull Width	5.93	ft
Bankfull Depth	0.338	ft
Bankfull Area	4.02	ft ²
Bankfull Streamflow	28.9	ft ³ /s

Bankfull Statistics Flow Report [Area-Averaged]

Statistic	Value	Unit
Bieger_D_channel_width	6.68	ft
Bieger_D_channel_depth	0.603	ft
Bieger_D_channel_cross_sectional_area	5.69	ft ²
Bieger_P_channel_width	5.16	ft
Bieger_P_channel_cross_sectional_area	4.44	ft ²
Bieger_P_channel_depth	0.536	ft

Statistic	Value	Unit
Bieger_USA_channel_width	6.77	ft
Bieger_USA_channel_depth	0.837	ft
Bieger_USA_channel_cross_sectional_area	6.77	ft ²
Bankfull Width	5.93	ft
Bankfull Depth	0.338	ft
Bankfull Area	4.02	ft ²
Bankfull Streamflow	28.9	ft ³ /s

Bankfull Statistics Citations

Bieger, Katrin; Rathjens, Hendrik; Allen, Peter M.; and Arnold, Jeffrey G., 2015, Development and Evaluation of Bankfull Hydraulic Geometry Relationships for the Physiographic Regions of the United States, Publications from USDA-ARS / UNL Faculty, 17p. (https://digitalcommons.unl.edu/usdaarsfacpub/1515?utm_source=digitalcommons.unl.edu%2Fusdaarsfacpub%2F1515&utm_medium=PDF&utm_campaign=PDFCoverPages)

Castro, J.M, and Jackson, P.L. Castro, J.M, and Jackson, P.L., 2001, Bankfull Discharge Recurrence Intervals and Regional Hydraulic Geometry Relationships: Patterns in the Pacific Northwest, USA, Journal of the American Water Resources Association, Volume 37, No. 5, 14 p. (<https://onlinelibrary.wiley.com/doi/abs/10.1111/j.1752-1688.2001.tb03636.x>)

USGS Data Disclaimer: Unless otherwise stated, all data, metadata and related materials are considered to satisfy the quality standards relative to the purpose for which the data were collected. Although these data and associated metadata have been reviewed for accuracy and completeness and approved for release by the U.S. Geological Survey (USGS), no warranty expressed or implied is made regarding the display or utility of the data for other purposes, nor on all computer systems, nor shall the act of distribution constitute any such warranty.

USGS Software Disclaimer: This software has been approved for release by the U.S. Geological Survey (USGS). Although the software has been subjected to rigorous review, the USGS reserves the right to update the software as needed pursuant to further analysis and review. No warranty, expressed or implied, is made by the USGS or the U.S. Government as to the functionality of the software and related material nor shall the fact of release constitute any such warranty. Furthermore, the software is released on condition that neither the USGS nor the U.S. Government shall be held liable for any damages resulting from its authorized or unauthorized use.

USGS Product Names Disclaimer: Any use of trade, firm, or product names is for descriptive purposes only and does not imply endorsement by the U.S. Government.

Application Version: 4.8.1

StreamStats Services Version: 1.2.22

NSS Services Version: 2.1.2

Attachment L

Adjacent Property Owner Address Labels

WEYERHAEUSER NR COMPANY
220 OCCIDENTAL AVE S
SEATTLE, WA 98104

COLUMBIA COUNTY
230 STRAND ST
ST HELENS, OR 97051

MEGAN FITZSIMMONS & KENNETH
MCFARLAND
60310 WAPITI DR
ST HELENS, OR 97051

FLYING F LLC
PO BOX 3525
PORTLAND, OR 97231

D L FREYTAG
P O BOX 216
ST HELENS, OR 97051

ADRIAN & FELIPE VELAZQUEZ
60300 WAPITI DR
ST HELENS, OR 97051

ICDC II LLC
14855 SE 82ND DR
CLACKAMAS, OR 97015

WATTERS L R & WATTERS W M
TESTAMENT TRT
2035 SE MAIN ST
PORTLAND, OR 97231

MITCHEAL ROY JENSEN
60290 WAPITI DR
ST HELENS, OR 97051

FLORIAN DAVIS
6950 NW KANSAS CITY RD
FOREST GROVE, OR 97116

RANDALL S AND ANNA R STAMPER
32376 RED HAWK LN
SCAPPOOSE, OR 97056

AMANDA G & TROY A MILLER
60280 WAPITI DR
ST HELENS, OR 97051

JAMES S, MICHAEL S, & BONNIE LEE
MAUCK
10940 SW LANCASTER RD
PORTLAND, OR 97231

RONALD C & JANELLE L VANDOLAH
2205 BUTTERFIELD RD #SPC #210
YAKIMA, WA 98901

LARRY W & REBECCA L COOK
60270 WAPITI DR
ST HELENS, OR 97051

NSA PROPERTY HOLDINGS LLC
14855 SE 82ND DR
CLACKAMAS, OR 97015

AARON J SHIERK
2034 COLUMBIA BLVD #PMB 506
ST HELENS, OR 97051

ROBERT FREDERICK & SHAUNA M
ECKERT
60260 WAPITI DR
ST HELENS, OR 97051

EASY 2 WASH LLC
460 W MARINE DR
ASTORIA, OR 97103

ST HELENS ASSETS LLC
PO BOX 288
WASHOUGAL, WA 98671

KIMBERLY A. LOBBY
60250 WAPITI DR
ST HELENS, OR 97051

DAVE B & JILL A LAWRENCE
1765 7TH ST
COLUMBIA CITY, OR 97018

EDWIN N & CYNTHIA A BARKER
603 WAPITI DR
ST HELENS, OR 97051

MARK V & ROCHELLE M RUSSELL
60240 WAPITI DR
ST HELENS, OR 97051

COLUMBIA RIVER PUD
RICK LUGAR
PO BOX 1193
ST HELENS, OR 97051

JACQUILINE M SINCLAIR
60330 WAPITI DR
ST HELENS, OR 97051

JOHN P LEDIAEV JR
60230 WAPITI DR
ST HELENS, OR 97051

WEYERHAEUSER NR COMPANY
32260 OLD HWY 34
TANGENT, OR 97389

HAZEL C MOSS
60320 WAPITI DR
ST HELENS, OR 97051-3752

VALERIE A HUEBNER & DAVID A SLAY
60220 WAPITI DR
ST HELENS, OR 97051

RICK & LORRI BLEVENS
60210 WAPITI DR
ST HELENS, OR 97051

RAYMOND & JANICE ANDREWS FAMILY
TRUST
60200 WAPITI DR
ST HELENS, OR 97051